



**THE DATASHEET OF  
LRMAT2010-R01FT4**



# Low Resistance Metal Alloy Resistors

## LRMA Series

### Features:

- Resistance range 0.5mΩ to 500mΩ
- High temperature operation to 170°C
- Low thermal EMF version
- High power version
- Inverse version
- Current sensing for power electronics
- AEC-Q200 qualified

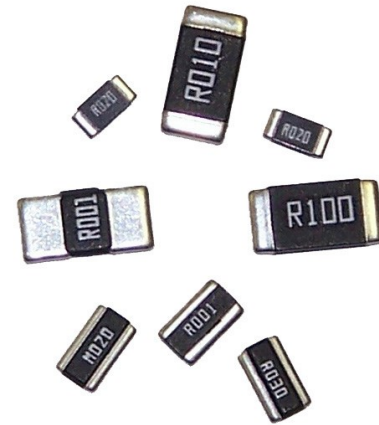

All parts are Pb-free and comply with EU Directive 2011/65/EU amended by (EU) 2015/863 (RoHS3)

### Electrical Data

Version T (Standard)		LRMAT2010	LRMAT2512
Power rating @70°C	W	1.5	≤R01: 2, >R01: 1
Overload rating (5s)	W	7.5	≤R01: 10, >R01: 5
Resistance range	mΩ	2 to 50	1 to 100
Standard values <sup>1</sup>	mΩ	2, 5, 6, 10, 15, 20, 50	1, 1.5, 2, 3, 3.5, 4, 5, 6, 7, 8, 10, 11, 12, 15, 18, 20, 25, 30, 33, 35, 40, 50, 100
Resistance tolerance	%	0.5 <sup>1</sup> , 1, 5	
TCR (25 to 125°C)	ppm/°C	≥R01: ±75, >R001 & <R01: ±100, ≤R001: ±275	
Ambient temperature	°C	-55 to 170	
Insulation resistance	MΩ	>100	
Element alloy		Cu-Ni	

Version P (Power)		LRMAP2512
Power rating @70°C	W	≤R10: 3, >R10: 2
Overload rating (5s)	W	≤R10: 15, >R10: 10
Resistance range	mΩ	0.5 to 500
Standard values <sup>1</sup>	mΩ	0.5, 0.75, 1, 1.1, 1.5, 2, 2.5, 3, 4, 5, 6, 6.8, 7, 8, 9, 10, 11, 12, 13, 15, 18, 20, 22, 25, 27, 30, 33, 39, 40, 45, 47, 50, 57, 60, 68, 70, 75, 80, 85, 90, 100, 120, 130, 140, 150, 180, 200, 220, 240, 250, 270, 280, 300, 330, 390, 400, 500
Resistance tolerance	%	0.5 <sup>1</sup> , 1, 5
TCR (25 to 125°C)	ppm/°C	≥R001: ±50, <R001: ±275
Ambient temperature	°C	-55 to 170
Insulation resistance	MΩ	>100
Element alloy		Cu-Ni / Mn-Cu

Version M (Low thermal EMF)		LRMAM0805	LRMAM1206	LRMAM2512
Power rating @70°C	W	0.5	1	≤R01: 2, >R01: 1
Overload rating (5s)	W	2.5	5	≤R01: 10, >R01: 5
Resistance range	mΩ	1 to 25	1 to 50	0.5 to 50
Standard values <sup>1</sup>	mΩ	1, 2, 3, 5, 6, 8, 9, 10, 20, 25	1, 1.2, 2, 2.5, 3, 4, 5, 6, 7, 8, 9, 10, 12, 14, 15, 18, 20, 22, 25, 30, 39, 40, 50	0.5, 0.75, 1, 1.5, 2, 3.5, 5, 10, 20, 25, 30, 40, 50
Resistance tolerance	%	0.5 <sup>1</sup> , 1, 5		
TCR (25 to 125°C)	ppm/°C	±100	±50	≥R01: ±75, >R001 & <R01: ±100, ≤R001: ±275
Ambient temperature	°C	-55 to 170		
Insulation resistance	MΩ	>100		
Element alloy		Mn-Cu		

#### General Note

TT Electronics reserves the right to make changes in product specification without notice or liability. All information is subject to TT Electronics' own data and is considered accurate at time of going to print.

### Electrical Data (continued)

Version N (Inverse)		LRMAN0612	LRMAN0815	LRMAN1225
Power rating @70°C	W	1 <sup>2</sup>		3
Overload rating (5s)	W	5		15
Resistance range	mΩ	1 to 10	1 to 30	2 to 40
Standard values <sup>1</sup>	mΩ	1, 3, 5, 10	1, 2, 3, 4, 5, 6, 8, 10, 15, 20, 25, 30	2, 3, 4, 5, 10, 15, 20, 25, 30, 40
Resistance tolerance	%	0.5 <sup>1</sup> , 1, 5		
TCR (25 to 125°C)	ppm/°C	±100		
Ambient temperature	°C	-55 to 170		
Insulation resistance	MΩ	>100		
Element alloy		Cu-Ni / Mn-Cu		

Notes: 1. Non-standard values and 0.5% tolerance may be available for high volume requirements.  
 2. Requires 300mm<sup>2</sup> copper pad & trace area.

### Physical Data

Dimensions in mm and weight in mg		Tolerances ±0.2mm unless stated				
Type	Value (mΩ)	L	W	C	t	Wt. nom.
LRMAT2010	All	5	2.5	0.6 ±0.3	0.6	36
LRMAT2512	<1	6.4	3.2	2.6	0.6	62
	≥1 & ≤3			2.2		
	>3			0.9		
LRMAP2512	<1	6.4	3.2	2.6	0.6	57
	≥1 & ≤4			2.2		
	>4			0.9		
LRMAM0805	≤2	2 ±0.1	1.25 ±0.1	0.6	0.6	5.5
	>2			0.4		
LRMAM1206	<2	3.2	1.6	1.1 ±0.3	0.75	18
	≥2			0.5 ±0.3	0.6	
LRMAM2512	<1	6.4	3.2	2.6	0.6	62
	≥1 & ≤3			2.2		
	>3			0.9		
LRMAN0612	All	1.7	3.2	0.4	0.6	13
LRMAN0815	All	2.3	3.75 ±0.3	0.5	0.7	14
LRMAN1225	All	3.2 ±0.3	6.4 ±0.3	0.5	0.9	70

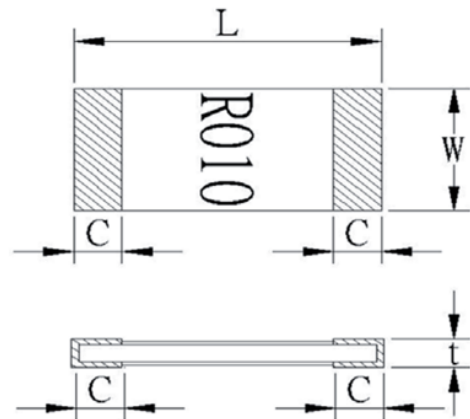

### Construction

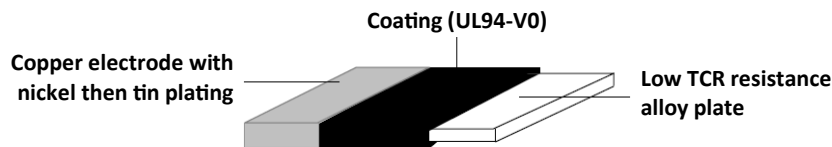

### Marking

The components are marked with ohmic value, e.g. "R002"=2mΩ, "R010"=10 mΩ. Due to space restrictions, for LRMAM1206, "01" = 1mΩ is used, and for LRMAM0805, "2" = 2mΩ and "010" = 10mΩ are used.

### Solvent Resistance

The component is resistant to all normal industrial cleaning solvents suitable for printed circuits.

### Performance Data

Test	Methods	Size:	Maximum		Typical
			0805	Others	All
Load at rated power	Cyclic load, 1000 hours at 70°C	±ΔR%	1.5	1	0.3
Short term overload	5x rated power for 5s	±ΔR%	0.5		0.15
Humidity	1000 hours, 85°C, 85%RH	±ΔR%	1	0.5	0.15
Temperature cycle	-40 to +125°C, 1000 cycles, 15-minute dwell	±ΔR%	1	0.5	0.15
Resistance to solder heat	260°C ±5°C for 20s ±1s	±ΔR%	0.5		0.3
Solderability	245°C ±5°C for 2s ±0.5s		>95% coverage		
Dry heat	1000 hours, 170°C	±ΔR%	1.5	0.5	0.3
Low temperature storage	1000 hours, -55°C	±ΔR%	0.5		0.15
Substrate bending	Board 1.6mm, fulcrum spacing 90mm, deflection 2mm	±ΔR%	1	0.5	0.3
Insulation resistance	1 minute, 100Vdc		>100M		
Sulphur resistance	ASTM B-809-95 (modified) 1000 hours, 105°C dry, visual inspection x10		Pass		

### Thermal Performance & Mounting

Temperature Derating

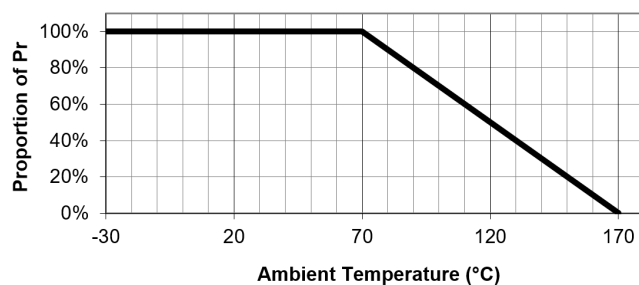

Typical Temperature Rise

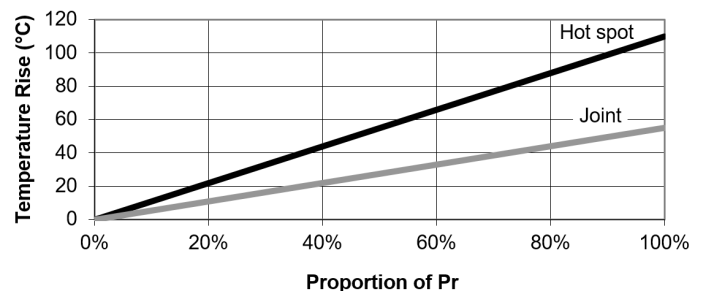

The temperature rise shown is highly dependent on mounting conditions. Reference conditions assume 20µm copper with thermal vias to multiple layers. The self-heating in the current tracks should be kept negligible, or allowed for by temperature derating.

### Reference Pad Dimensions (mm)

Type	Value (mΩ)	a	b	L
LRMAT2010	All	3.4	1.5	3.5
LRMAT2512	≤3	4	3.1	1.3
	>3		2.1	4.1
LRMAP2512	≤4	4	3.1	1.3
	>4		2.1	4.1
LRMAM0805	All	1.4	1.15	1.2
LRMAM1206	<2	1.8	2.3	1
	≥2		1.7	1.6
LRMAM2512	≤3	4	3.1	1.3
	>3		2.1	4.1
LRMAN0612	All	3.8	0.7	0.7
LRMAN0815	≤10	4.2	0.8	1.2
	>10		1.5	0.9
LRMAN1225	All	7	1	2.3

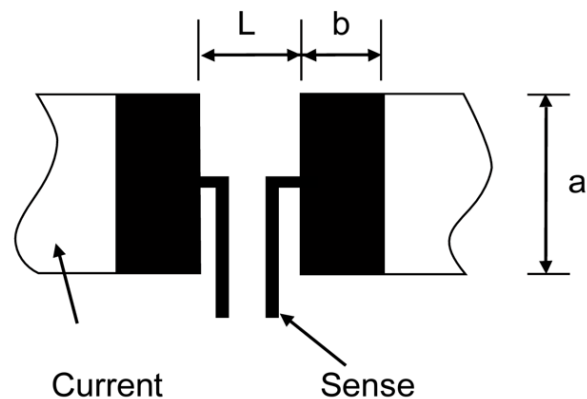

### Measurement Probe Positions

Standard 4-terminal probe pitches for measuring unmounted parts are 2.8 x 1.7mm (0612), 0.4 x 1.83mm (0805), 0.4 x 2.8mm (1206), 1.2 x 4.5mm (2010), 1.5 x 5.8mm (2512), and 5.4 x 3.4mm (1225). All probe location tolerances ±0.02mm. These resistors are designed to have the correct ohmic value when mounted on a PCB. Probed measurements may read higher values and mounting offsets may need to be established to account for this, especially with sub-milliohm values.

## LRMA Series

### Packaging

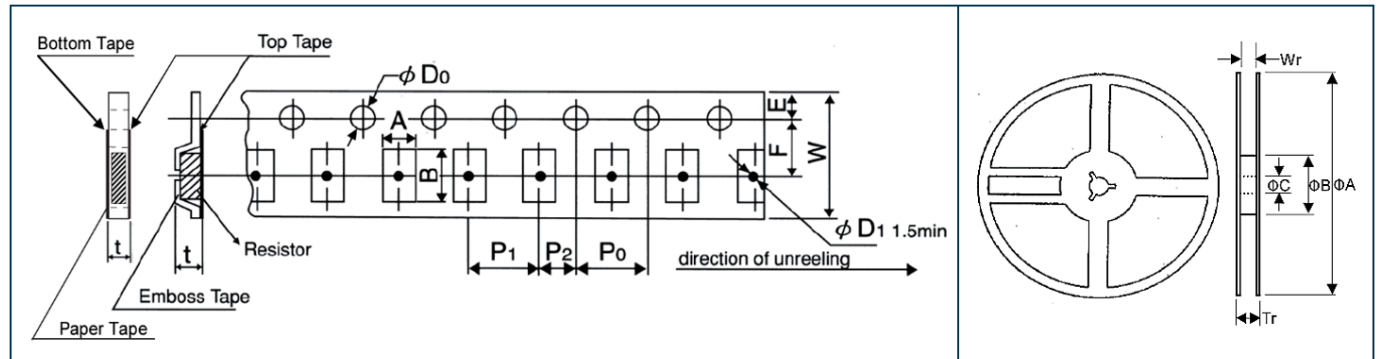

All dimensions in mm

Size	Tape	A	B	W	F	E	P <sub>1</sub>	P <sub>2</sub>	P <sub>0</sub>	ϕD <sub>0</sub>	t	ϕA	ϕB	ϕC	Wr	Tr	Qty
0805	Paper	1.6 ±0.15	2.4 ±0.2	8.0 ±0.2	3.5 ±0.05						0.84 ±0.1				9 ±1	11.4 ±1.1	5000
1206/0612		2.0 ±0.15	3.6 ±0.2														
0815	Embossed plastic	2.6 ±0.2	4.5 ±0.2	12 ±0.2	5.5 ±0.1	1.75 ±0.1	4.0 ±0.1	2.0 ±0.2	4.0 ±0.1	1.5 +0.1 /-0	1.1 ±0.1	178 ±2	60 ±1	13 ±1	13 ±1	15.4 ±2	4000
2010		2.8 ±0.2	5.3 ±0.2														
2512/1225		3.6 ±0.2	6.9 ±0.2														

### Storage

**Conditions:** 5°C to 35°C and 40% to 75%RH

**Shelf life:** 2 years from manufacture

### Processing

LRMA series resistors are suitable for both wave and IR reflow soldering. The recommended reflow profile for Pb-free SAC305 alloy (Sn 96.5%, Ag 3%, Cu 0.5%) soldering is as follows:

**Pre-heat:** 60s to 120s at 150°C to 180°C

**Soldering:** 20s to 40s at ≥230°C

**Peak:** 5s at 255°C to 260°C

### Ordering Procedure

**Example:** LRMAM2512-R01FT4 (LRMA with low thermal EMF, 2512, 10 milliohms ±1%, Pb-free)



1	2	3	4	5	6		
Series	Version	Size	Value	Tolerance	Packing		
LRMA	T	Standard	3 to 6 characters R = ohms	D = ±0.5%	Tape & reel		
	P	Power		F = ±1%	T5	0612, 0805, 1206	5000/reel
	M	Low thermal EMF		J = ±5%	T4	0815, 1225, 2010, 2512	4000/reel
	N	Inverse		1206			
				1225			
2010							
2512							

Note 1: For values which require all 6 characters, e.g. R00075, the hyphen is omitted.



## Looking for pricing, stock, or lifecycle information?

Click below to explore more details on WIN SOURCE:

 [View LRMAT2010-R01FT4 on WIN SOURCE](#)

 [TT Electronics](#) Information

## Optimize Your Supply Chain with WIN SOURCE Solutions

-  Global Sourcing Solution
-  Obsolete Management
-  Cost Control Management
-  Shortage Management
-  Alternative Solution
-  Excess Inventory Management