



**THE DATASHEET OF
LM3620M5-4**



LM3620 Lithium-Ion Battery Charger Controller

Check for Samples: [LM3620](#)

FEATURES

- **Voltage Options for Charging 1 or 2 Cell Stacks**
- **Adjustable Output Voltage for Coke or Graphite Anodes**
- **Precision End-of-Charge Voltage Control**
- **Wide Input Voltage Range (4V to 30V)**
- **Low Off State Current (<10nA)**
- **Drive Provided for External Power Stage**
- **Tiny SOT-23 Package**

DESCRIPTION

The LM3620 series of controllers are monolithic integrated circuits designed to control the charging and end-of-charge control for lithium-ion rechargeable batteries. The LM3620 is available in two versions for one or two cell charger applications. Each version provides the option of selecting the appropriate termination voltage for either coke or graphite anode lithium cells.

The LM3620 can operate from a wide range of DC input sources (4V to 30V). With no charger supply connected, the controller draws a quiescent current of only 10nA to minimize discharging of a connected battery pack.

The LM3620 consists of an operational transconductance amplifier, a bandgap voltage reference, a NPN driver transistor and precision voltage setting resistors. The output of the amplifier is made available to drive an external power transistor if higher drive currents are required.

With a trimmed output voltage regulation of $\pm 1.2\%$ initial accuracy, the LM3620 provides a simple, precise solution for end-of-charge control of lithium-ion rechargeable cells.

The LM3620 is packaged in a miniature 5-lead SOT-23 surface mount package for very compact designs.



Please be aware that an important notice concerning availability, standard warranty, and use in critical applications of Texas Instruments semiconductor products and disclaimers thereto appears at the end of this data sheet.

All trademarks are the property of their respective owners.

Typical Application

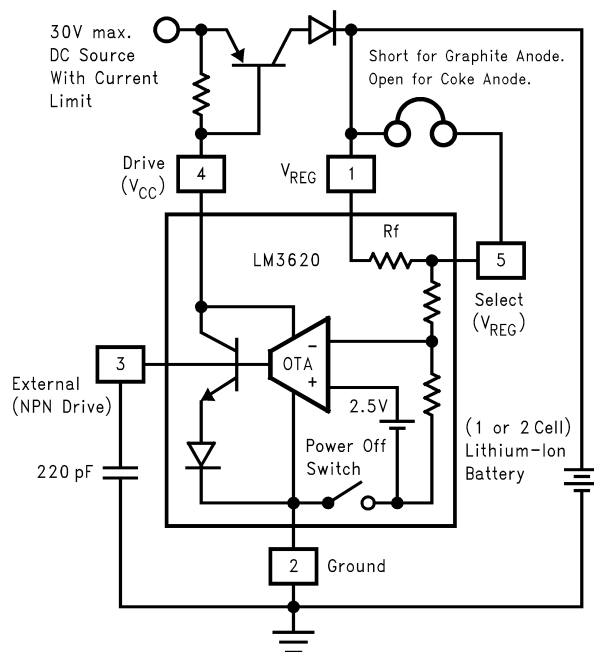

Connection Diagram

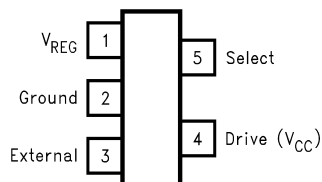

The small physical size of the SOT23-5 Package does not allow for the full part number marking. Devices will be marked with the designation shown in the column Package Marking.

**Figure 1. 5-Lead SOT23-5 Surface Mount Package
See Package MF05A**



These devices have limited built-in ESD protection. The leads should be shorted together or the device placed in conductive foam during storage or handling to prevent electrostatic damage to the MOS gates.

ABSOLUTE MAXIMUM RATINGS⁽¹⁾⁽²⁾

Input Voltage (V_{DRIVE})		35V
V_{EXT}		1.5V
Junction Temperature		150°C
Storage Temperature		-65 to +150°C
Lead Temp. Soldering	Vapor Phase (60 sec.)	215°C
	Infrared (15 sec.)	220°C
Power Dissipation ($T_A = 25^\circ\text{C}$) ⁽³⁾		300mW
ESD Susceptibility ⁽⁴⁾		2000V

- (1) Absolute Maximum Ratings indicate limits beyond which damage to the device may occur. Operating Ratings indicate conditions for which the device is intended to be functional, but do not ensure specific performance limits. For ensured specifications and test conditions, see the Electrical Characteristics.
- (2) If Military/Aerospace specified devices are required, please contact the TI Sales Office/ Distributors for availability and specifications.
- (3) The maximum power dissipation must be derated at elevated temperatures and is limited by T_{JMAX} (maximum junction temperature), θ_{J-A} (junction-to-ambient thermal resistance) and T_A (ambient temperature). The maximum power dissipation at any temperature is: $P_{DISSMAX} = (T_{JMAX} - T_A)/\theta_{J-A}$ up to the value listed in the Absolute Maximum Ratings.
- (4) Rating is for the human body model, a 100 pF capacitor discharged through a 1.5k Ω resistor into each pin.

OPERATING RATINGS⁽¹⁾

Ambient Temp. Range	0°C to 70°C
Junction Temp. Range	0°C to 125°C
Thermal Resistance (Junction to Ambient, θ_{J-A})	280°C/W
Input Voltage (V_{DRIVE})	4V to 30V

- (1) Absolute Maximum Ratings indicate limits beyond which damage to the device may occur. Operating Ratings indicate conditions for which the device is intended to be functional, but do not ensure specific performance limits. For ensured specifications and test conditions, see the Electrical Characteristics.

ELECTRICAL CHARACTERISTICS LM3620-4

$V_{DRIVE} = 5V$, $I_{DRIVE} = 2mA$. Limits with **boldface type** apply over the full operating ambient temperature range, 0°C to +70°C, limits with standard typeface apply for $T_A = 25^\circ\text{C}$.

Symbol	Parameter	Conditions	Typical	Limit	Units
V_{REG}	Regulated Output Voltage (pin 1 to ground)	Pin 5 shorted to pin 1 (graphite anode)	4.1	4.051/ 4.018	V(min)
				4.149/ 4.182	V(max)
	Regulated Output Voltage Tolerance	Pin 5 open (coke anode)	4.2	4.150/ 4.116	V(min)
		Either Pin 5 setting		4.250/ 4.284	V(max)
				$\pm 1.2/\pm 2.0$	%
V_{REG}/V_{DRIVE}	Supply Sensitivity	V_{REG} for $5V \leq V_{DRIVE} \leq 30V$	100		$\mu V/V$ (max)
I_Q	Quiescent Current	$V_{REG} = 4.5V$, $V_{EXT} = 1.0V$ ⁽¹⁾	400	750	μA (max)
I_{OFF}	Off State Current	V_{DRIVE} open circuited ⁽²⁾	10	200	nA(max)
I_{DRIVE}	Drive Pin Sink Current	$V_{DRIVE} = 5.0V$	20	15	mA(min)
$G_{m(DRIVE)}$	Drive Pin Transconductance	$\Delta I_{DRIVE}/\Delta V_{REG}$ $2mA \leq I_{DRIVE} \leq 15mA$	3		A/V
I_{EXT}	External Pin Source Current	$V_{EXT} = 1V$ ⁽³⁾	3	2.5	mA(min)

- (1) Quiescent current is all current flowing to ground when the voltage at the V_{REG} pin is forced to be above the nominal regulating voltage (V_{REG}).
- (2) Off current is all of the current flowing to ground including all leakage current that would be drawn from the battery connected to the V_{REG} terminal.
- (3) When the External pin is being used as the driving source, it is recommended to keep the operating point of $V_{EXT} \leq 1V$. If greater than 1V, the internal circuitry would bias I_{DRIVE} to conduct up to the current limit level continuously causing unnecessary power dissipation in the device.

ELECTRICAL CHARACTERISTICS LM3620-4 (continued)

$V_{DRIVE} = 5V$, $I_{DRIVE} = 2mA$. Limits with **boldface type** apply over the full operating ambient temperature range, $0^{\circ}C$ to $+70^{\circ}C$, limits with standard typeface apply for $T_A = 25^{\circ}C$.

Symbol	Parameter	Conditions	Typical	Limit	Units
$G_{m(EXT)}$	External Pin Transconductance	$\Delta I_{EXT}/\Delta V_{REG}$, $V_{EXT} = 1V$ $0mA \leq I_{EXT} \leq 2.5mA$	0.8		A/V
R_{IN}	V_{REG} Input Resistance	Pin 1 to Ground.	46		k Ω
		Circuit biased with V_{DRIVE} applied V_{DRIVE} open circuited	42		M Ω
R_F	Feedback Resistance	Pin 1 to Pin 5	1500		Ω

LM3620-8

$V_{DRIVE} = 5V$, $I_{DRIVE} = 2mA$. Limits with **boldface type** apply over the full operating ambient temperature range, $0^{\circ}C$ to $+70^{\circ}C$, limits with standard typeface apply for $T_A = 25^{\circ}C$.

Symbol	Parameter	Conditions	Typical	Limit	Units
V_{REG}	Regulated Output Voltage (pin 1 to ground)	Pin 5 shorted to pin 1 (graphite anode)	8.2	8.102/ 8.036	V(min)
				8.298/ 8.364	V(max)
	Regulated Output Voltage Tolerance	Pin 5 open (coke anode)	8.4	8.299/ 8.232	V(min)
				8.501/ 8.568	V(max)
		Either Pin 5 setting		$\pm 1.2/\pm 2.0$	%
V_{REG}/V_{DRIVE}	Supply Sensitivity	V_{REG} for $5V \leq V_{DRIVE} \leq 30V$	200		$\mu V/V$ (max)
I_Q	Quiescent Current	$V_{REG} = 8.7V$, $V_{EXT} = 1.0V^{(1)}$	400	750	μA (max)
I_{OFF}	Off State Current	V_{DRIVE} open circuited ⁽²⁾	10	200	nA(max)
I_{DRIVE}	Drive Pin Sink Current	$V_{DRIVE} = 5.0V$	20	15	mA(min)
$G_{m(DRIVE)}$	Drive Pin Transconductance	$\Delta I_{DRIVE}/\Delta V_{REG}$ $2mA \leq I_{DRIVE} \leq 15mA$	1.5		A/V
I_{EXT}	External Pin Source Current	$V_{EXT} = 1V^{(3)}$	3	2.5	mA(min)
$G_{m(EXT)}$	External Pin Transconductance	$\Delta I_{EXT}/\Delta V_{REG}$, $V_{EXT} = 1V$ $0mA \leq I_{EXT} \leq 2.5mA$	0.4		A/V
R_{IN}	V_{REG} Input Resistance	Pin 1 to Ground.	110		k Ω
		Circuit biased with V_{DRIVE} applied V_{DRIVE} open circuited	42		M Ω
R_F	Feedback Resistance	Pin 1 to Pin 5	2900		Ω

- (1) Quiescent current is all current flowing to ground when the voltage at the V_{REG} pin is forced to be above the nominal regulating voltage (V_{REG}).
- (2) Off current is all of the current flowing to ground including all leakage current that would be drawn from the battery connected to the V_{REG} terminal.
- (3) When the External pin is being used as the driving source, it is recommended to keep the operating point of $V_{EXT} \leq 1V$. If greater than 1V, the internal circuitry would bias I_{DRIVE} to conduct up to the current limit level continuously causing unnecessary power dissipation in the device.

TYPICAL PERFORMANCE CHARACTERISTICS

Unless otherwise specified, $T_A = 25^\circ\text{C}$.

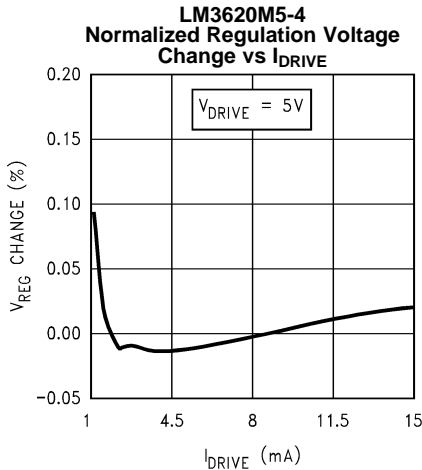

Figure 2.

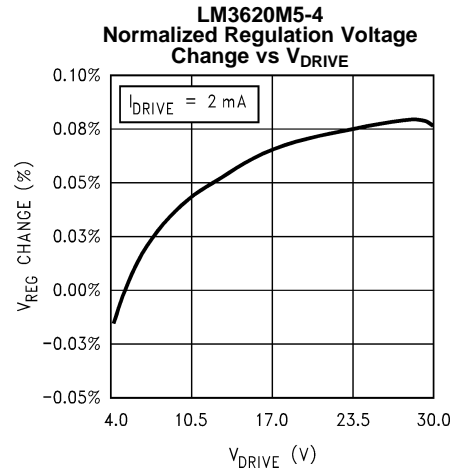

Figure 3.

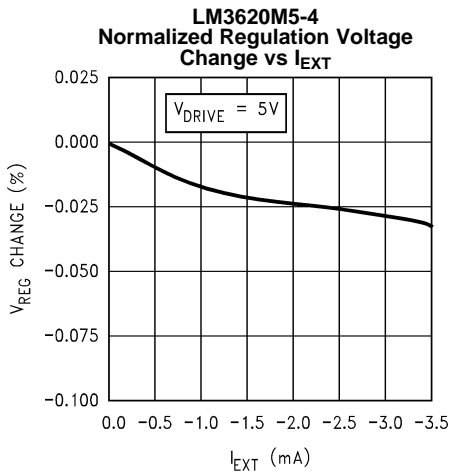

Figure 4.

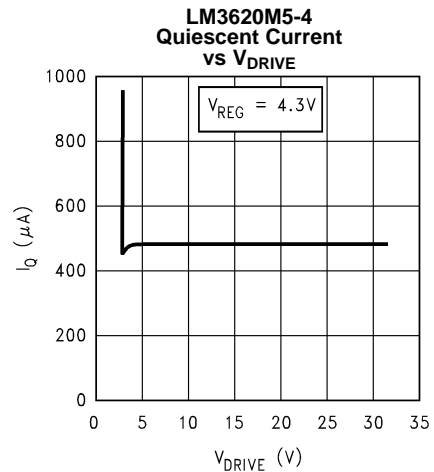

Figure 5.

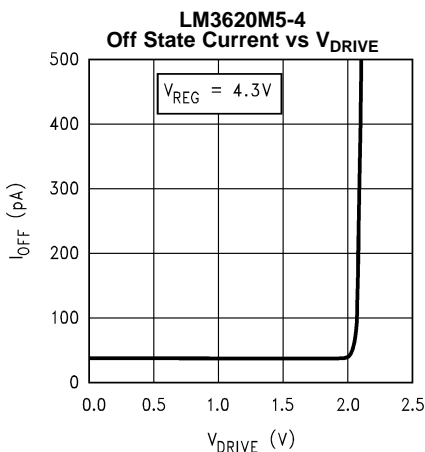

Figure 6.

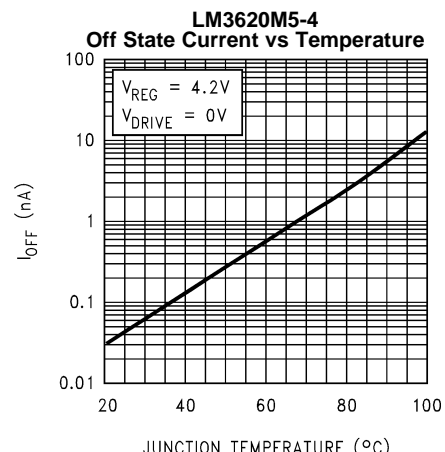
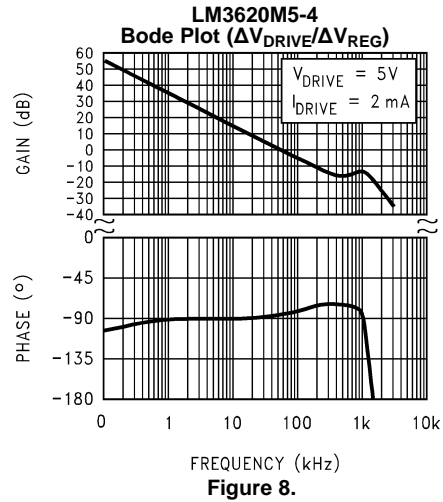

Figure 7.

TYPICAL PERFORMANCE CHARACTERISTICS (continued)

Unless otherwise specified, $T_A = 25^\circ\text{C}$.



REVISION HISTORY

Changes from Revision C (April 2013) to Revision D	Page
• Changed layout of National Data Sheet to TI format	5

IMPORTANT NOTICE

Texas Instruments Incorporated and its subsidiaries (TI) reserve the right to make corrections, enhancements, improvements and other changes to its semiconductor products and services per JESD46, latest issue, and to discontinue any product or service per JESD48, latest issue. Buyers should obtain the latest relevant information before placing orders and should verify that such information is current and complete. All semiconductor products (also referred to herein as "components") are sold subject to TI's terms and conditions of sale supplied at the time of order acknowledgment.

TI warrants performance of its components to the specifications applicable at the time of sale, in accordance with the warranty in TI's terms and conditions of sale of semiconductor products. Testing and other quality control techniques are used to the extent TI deems necessary to support this warranty. Except where mandated by applicable law, testing of all parameters of each component is not necessarily performed.

TI assumes no liability for applications assistance or the design of Buyers' products. Buyers are responsible for their products and applications using TI components. To minimize the risks associated with Buyers' products and applications, Buyers should provide adequate design and operating safeguards.

TI does not warrant or represent that any license, either express or implied, is granted under any patent right, copyright, mask work right, or other intellectual property right relating to any combination, machine, or process in which TI components or services are used. Information published by TI regarding third-party products or services does not constitute a license to use such products or services or a warranty or endorsement thereof. Use of such information may require a license from a third party under the patents or other intellectual property of the third party, or a license from TI under the patents or other intellectual property of TI.

Reproduction of significant portions of TI information in TI data books or data sheets is permissible only if reproduction is without alteration and is accompanied by all associated warranties, conditions, limitations, and notices. TI is not responsible or liable for such altered documentation. Information of third parties may be subject to additional restrictions.

Resale of TI components or services with statements different from or beyond the parameters stated by TI for that component or service voids all express and any implied warranties for the associated TI component or service and is an unfair and deceptive business practice. TI is not responsible or liable for any such statements.

Buyer acknowledges and agrees that it is solely responsible for compliance with all legal, regulatory and safety-related requirements concerning its products, and any use of TI components in its applications, notwithstanding any applications-related information or support that may be provided by TI. Buyer represents and agrees that it has all the necessary expertise to create and implement safeguards which anticipate dangerous consequences of failures, monitor failures and their consequences, lessen the likelihood of failures that might cause harm and take appropriate remedial actions. Buyer will fully indemnify TI and its representatives against any damages arising out of the use of any TI components in safety-critical applications.

In some cases, TI components may be promoted specifically to facilitate safety-related applications. With such components, TI's goal is to help enable customers to design and create their own end-product solutions that meet applicable functional safety standards and requirements. Nonetheless, such components are subject to these terms.

No TI components are authorized for use in FDA Class III (or similar life-critical medical equipment) unless authorized officers of the parties have executed a special agreement specifically governing such use.

Only those TI components which TI has specifically designated as military grade or "enhanced plastic" are designed and intended for use in military/aerospace applications or environments. Buyer acknowledges and agrees that any military or aerospace use of TI components which have **not** been so designated is solely at the Buyer's risk, and that Buyer is solely responsible for compliance with all legal and regulatory requirements in connection with such use.

TI has specifically designated certain components as meeting ISO/TS16949 requirements, mainly for automotive use. In any case of use of non-designated products, TI will not be responsible for any failure to meet ISO/TS16949.

Products

Audio	www.ti.com/audio
Amplifiers	amplifier.ti.com
Data Converters	dataconverter.ti.com
DLP® Products	www.dlp.com
DSP	dsp.ti.com
Clocks and Timers	www.ti.com/clocks
Interface	interface.ti.com
Logic	logic.ti.com
Power Mgmt	power.ti.com
Microcontrollers	microcontroller.ti.com
RFID	www.ti-rfid.com
OMAP Applications Processors	www.ti.com/omap
Wireless Connectivity	www.ti.com/wirelessconnectivity

Applications

Automotive and Transportation	www.ti.com/automotive
Communications and Telecom	www.ti.com/communications
Computers and Peripherals	www.ti.com/computers
Consumer Electronics	www.ti.com/consumer-apps
Energy and Lighting	www.ti.com/energy
Industrial	www.ti.com/industrial
Medical	www.ti.com/medical
Security	www.ti.com/security
Space, Avionics and Defense	www.ti.com/space-avionics-defense
Video and Imaging	www.ti.com/video

TI E2E Community

e2e.ti.com

Looking for pricing, stock, or lifecycle information?

Click below to explore more details on WIN SOURCE:

 [View LM3620M5-4](#) on WIN SOURCE

 [Texas Instruments](#) Information

Optimize Your Supply Chain with WIN SOURCE Solutions

-  Global Sourcing Solution
-  Obsolete Management
-  Cost Control Management
-  Shortage Management
-  Alternative Solution
-  Excess Inventory Management