

PC733H

High Input Current, AC Input Type Photocoupler

* Lead forming type (I type) and taping reel type (P type) are also available. (PC733HI/PC733HP)

■ Features

1. AC input response
2. High input current (I_F : MAX. 150mA)
3. High isolation voltage between input and output
(V_{iso} : 5 000 V_{rms})
4. Low collector dark current
(I_{CEO} : MAX. 10^{-7} A at $V_{CE} = 20V$)
5. TTL compatible output
6. Recognized by UL, file No. E64380

■ Applications

1. Telephone sets
2. System appliances, measuring instruments
3. Signal transmission between circuits of different potentials and impedances

■ Outline Dimensions

(Unit : mm)

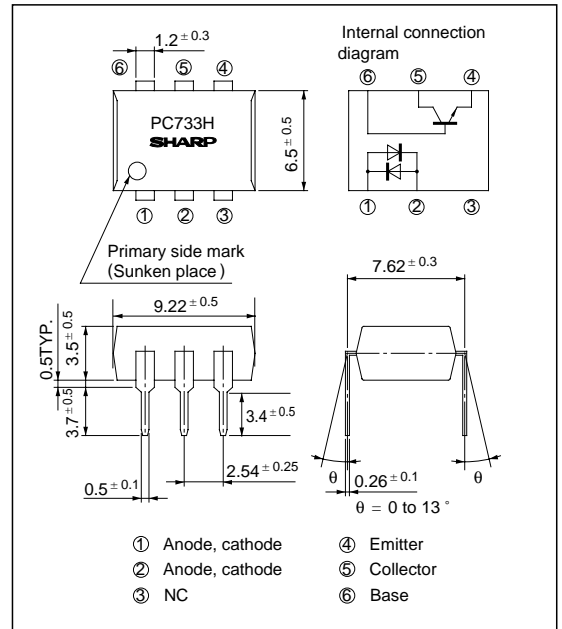

■ Absolute Maximum Ratings

($T_a = 25^\circ\text{C}$)

Parameter		Symbol	Rating	Unit
Input	Forward current	I_F	± 150	mA
	*1 Peak forward current	I_{FM}	± 1	A
	Power dissipation	P	230	mW
Output	Collector-emitter voltage	V_{CEO}	35	V
	Emitter-collector voltage	V_{ECO}	6	V
	Collector-base voltage	V_{CBO}	35	V
	Emitter-base voltage	V_{EBO}	6	V
	Collector current	I_C	80	mA
	Collector power dissipation	P_C	160	mW
	Total power dissipation	P_{tot}	320	mW
*2 Isolation voltage	V_{iso}	5 000	V_{rms}	
Operating temperature		T_{opr}	- 25 to + 100	$^\circ\text{C}$
Storage temperature		T_{stg}	- 55 to + 125	$^\circ\text{C}$
*3 Soldering temperature		T_{sol}	260	$^\circ\text{C}$

*1 Pulse width $\leq 100\mu\text{s}$, Duty ratio : 0.001

*2 40 to 60% RH, AC for 1 minute

*3 For 10 seconds

■ Electro-optical Characteristics

($T_a = 25^\circ\text{C}$)

Parameter		Symbol	Conditions	MIN.	TYP.	MAX.	Unit	
Input	Forward voltage	V_F	$I_F = \pm 100\text{mA}$	-	1.4	1.7	V	
	Peak forward voltage	V_{FM}	$I_{FM} = \pm 0.5\text{A}$	-	-	3.0	V	
	Terminal capacitance	C_t	$V = 0, f = 1\text{kHz}$	-	50	400	pF	
Output	Collector dark current	I_{CEO}	$V_{CE} = 20\text{V}, I_F = 0, R_{BE} = \infty$	-	-	10^{-7}	A	
	Current transfer ratio	CTR	$I_F = \pm 100\text{mA}, V_{CE} = 2\text{V}, R_{BE} = \infty$	20	-	80	%	
Transfer characteristics	Collector-emitter saturation voltage	$V_{CE(sat)}$	$I_F = \pm 100\text{mA}, I_C = 1\text{mA}, R_{BE} = \infty$	-	0.1	0.2	V	
	Isolation resistance	R_{ISO}	DC500V, 40 to 60% RH	5×10^{10}	10^{11}	-	Ω	
	Floating capacitance	C_f	$V = 0, f = 1\text{MHz}$	-	0.6	1.0	pF	
	Cut-off frequency	f_c	$V_{CE} = 5\text{V}, I_C = 2\text{mA}, R_L = 100\Omega, R_{BE} = \infty, -3\text{dB}$	-	15	80	-	kHz
				-	-	3	18	μs
	Response time	Rise time	t_r	$V_{CE} = 2\text{V}, I_C = 2\text{mA},$	-	4	18	μs
	Fall time	t_f	$R_L = 100\Omega, R_{BE} = \infty$	-	3	18	μs	

Fig. 1 Forward Current vs. Ambient Temperature

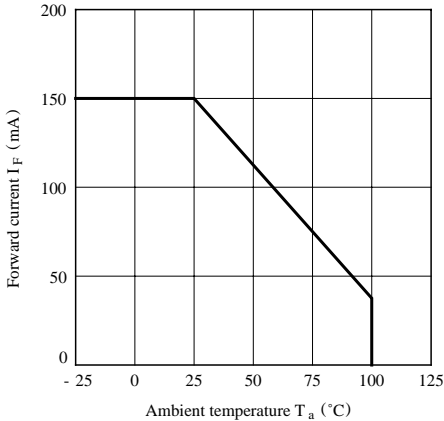

Fig. 2 Collector Power Dissipation vs. Ambient Temperature

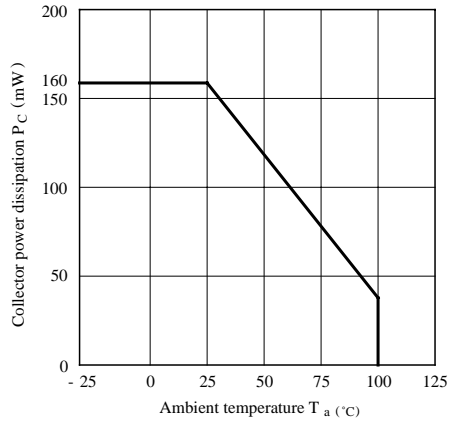

Fig. 3 Peak Forward Current vs. Duty Ratio

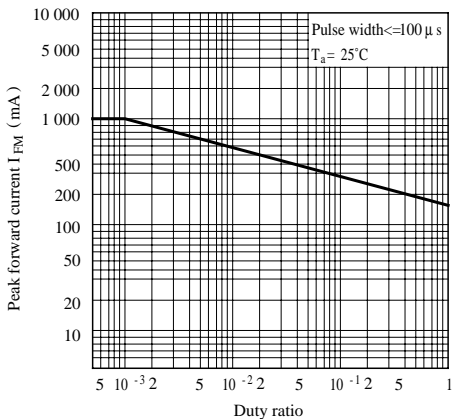

Fig. 4 Forward Current vs. Forward Voltage

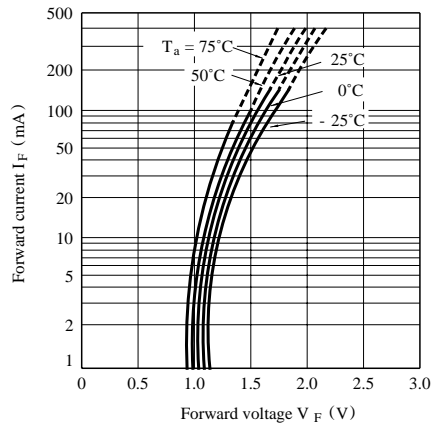

Fig. 5 Current Transfer Ratio vs. Forward Current

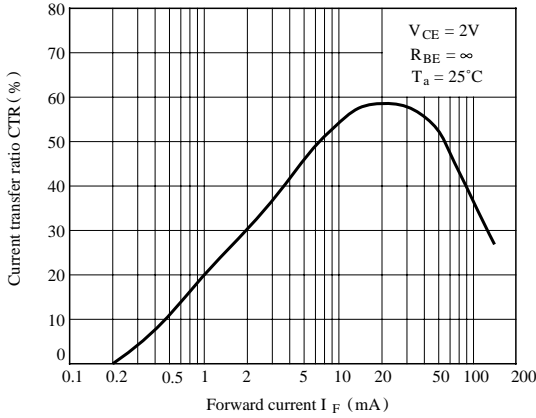

Fig. 6 Collector Current vs. Collector-emitter Voltage

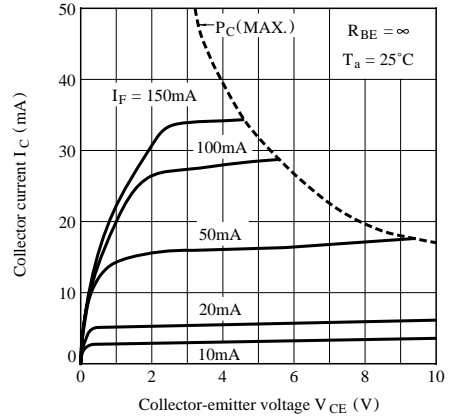

Fig. 7 Relative Current Transfer Ratio vs. Ambient Temperature

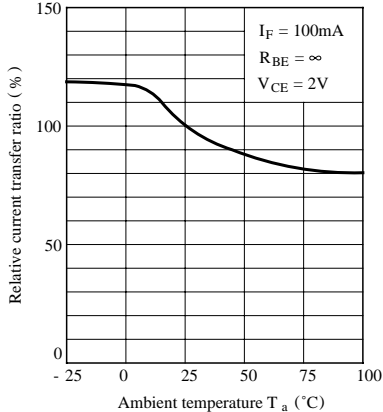

Fig. 8 Collector-emitter Saturation Voltage vs. Ambient Temperature

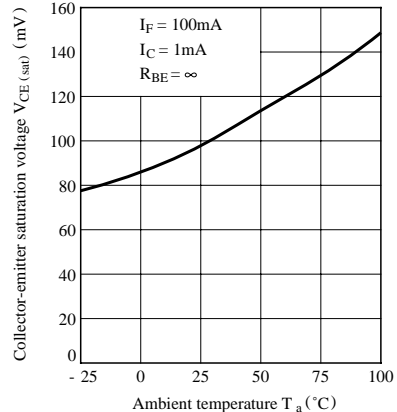

Fig. 9-a Collector Dark Current vs. Ambient Temperature

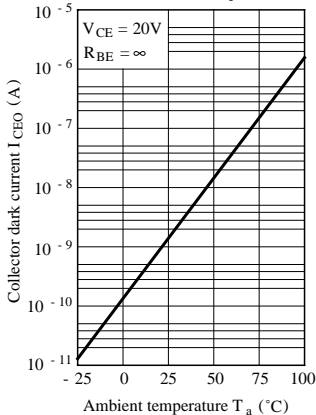

Fig. 9-b Collector-base Dark Current vs. Ambient Temperature

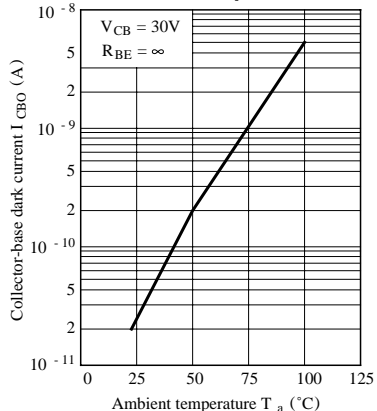

Fig.10 Response Time vs. Load Resistance

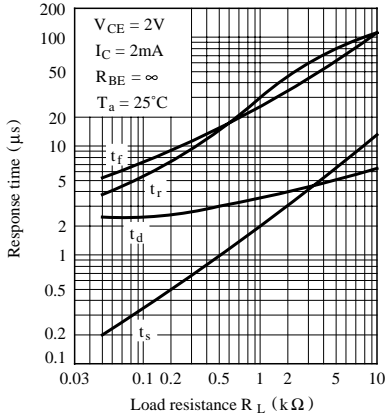
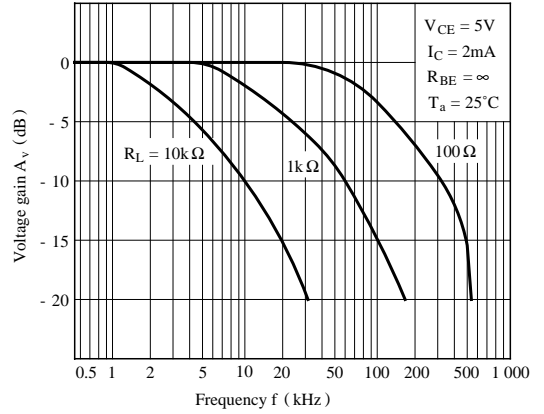
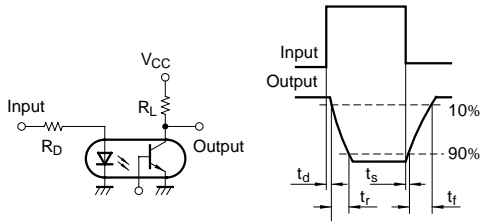

Fig.11 Frequency Response



Test Circuit for Response Time



Test Circuit for Frequency Response

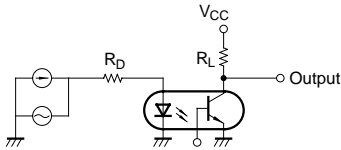
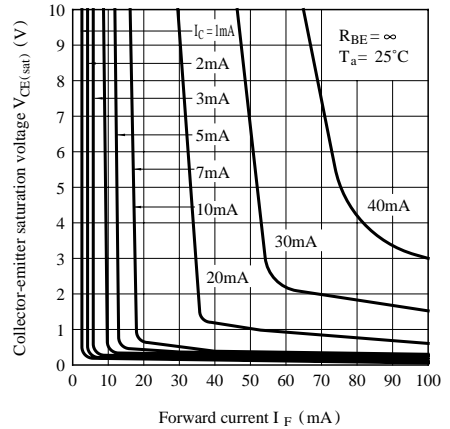

Fig.12 Collector-emitter Saturation Voltage vs. Forward Current





● Please refer to the chapter “Precautions for Use”.

NOTICE







- The circuit application examples in this publication are provided to explain representative applications of SHARP devices and are not intended to guarantee any circuit design or license any intellectual property rights. SHARP takes no responsibility for any problems related to any intellectual property right of a third party resulting from the use of SHARP's devices.
- Contact SHARP in order to obtain the latest device specification sheets before using any SHARP device. SHARP reserves the right to make changes in the specifications, characteristics, data, materials, structure, and other contents described herein at any time without notice in order to improve design or reliability. Manufacturing locations are also subject to change without notice.
- Observe the following points when using any devices in this publication. SHARP takes no responsibility for damage caused by improper use of the devices which does not meet the conditions and absolute maximum ratings to be used specified in the relevant specification sheet nor meet the following conditions:
 - (i) The devices in this publication are designed for use in general electronic equipment designs such as:
 - Personal computers
 - Office automation equipment
 - Telecommunication equipment [terminal]
 - Test and measurement equipment
 - Industrial control
 - Audio visual equipment
 - Consumer electronics
 - (ii) Measures such as fail-safe function and redundant design should be taken to ensure reliability and safety when SHARP devices are used for or in connection with equipment that requires higher reliability such as:
 - Transportation control and safety equipment (i.e., aircraft, trains, automobiles, etc.)
 - Traffic signals
 - Gas leakage sensor breakers
 - Alarm equipment
 - Various safety devices, etc.
 - (iii) SHARP devices shall not be used for or in connection with equipment that requires an extremely high level of reliability and safety such as:
 - Space applications
 - Telecommunication equipment [trunk lines]
 - Nuclear power control equipment
 - Medical and other life support equipment (e.g., scuba).
- Contact a SHARP representative in advance when intending to use SHARP devices for any "specific" applications other than those recommended by SHARP or when it is unclear which category mentioned above controls the intended use.
- If the SHARP devices listed in this publication fall within the scope of strategic products described in the Foreign Exchange and Foreign Trade Control Law of Japan, it is necessary to obtain approval to export such SHARP devices.
- This publication is the proprietary product of SHARP and is copyrighted, with all rights reserved. Under the copyright laws, no part of this publication may be reproduced or transmitted in any form or by any means, electronic or mechanical, for any purpose, in whole or in part, without the express written permission of SHARP. Express written permission is also required before any use of this publication may be made by a third party.
- Contact and consult with a SHARP representative if there are any questions about the contents of this publication.

Looking for pricing, stock, or lifecycle information?

Click below to explore more details on WIN SOURCE:

-  [View PC733J00000F on WIN SOURCE](#)
-  [Sharp Microelectronics](#) Information

Optimize Your Supply Chain with WIN SOURCE Solutions

-  Global Sourcing Solution
-  Obsolete Management
-  Cost Control Management
-  Shortage Management
-  Alternative Solution
-  Excess Inventory Management