



**THE DATASHEET OF
G88MP20102CEU**



This document is the property of Amphenol Corporation and is delivered on the express understanding that it is to be disclosed only to those individuals, departments or entities specifically named in the release order. Amphenol Corporation, its subsidiaries, agents, or other authorized representatives shall not be held responsible for any disclosure of this information to any other party without its prior consent, and that no right is granted to disclose or to use any information in this document.

The marking on this product doesn't contain environmental hazardous materials per Material Specification 35-00259 for Sony GP compliant or per directive 2011/65/EU for RoHS compliant.

SYM
A
BX1
E

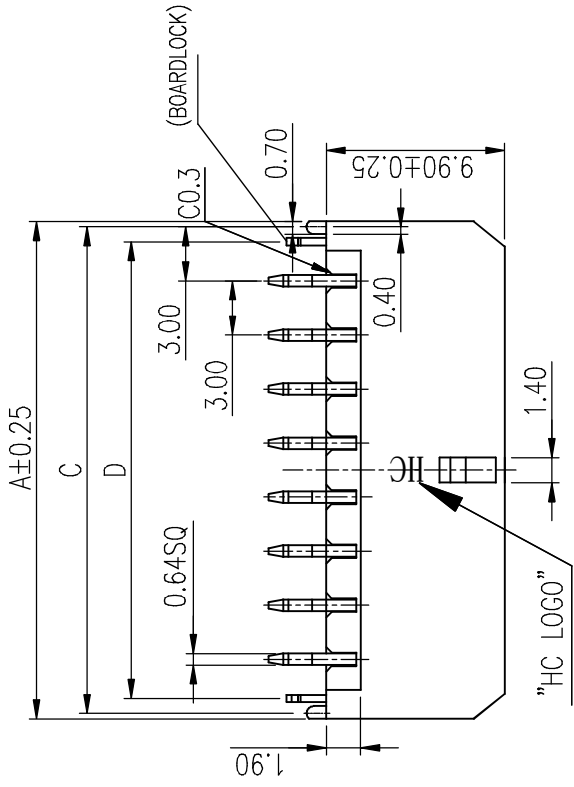

NOTE:
 1. MATERIAL INSULATOR: HIGH CONTACT MATERIAL
 BOARDLOCK: COPPER
 2. FINISH:
 CONTACT: SELECTIVE SOLDERING AREA: N UNDER PLATING: N BOARDLOCK: MATTE TIN 100u" UNDER PLATING: N 4. THIS PRODUCT DOES NOT CONTAIN MATERIALS PER DIPLOMA 6. TO ENSURE CURRENT CARRY (G88MPH CABLE F

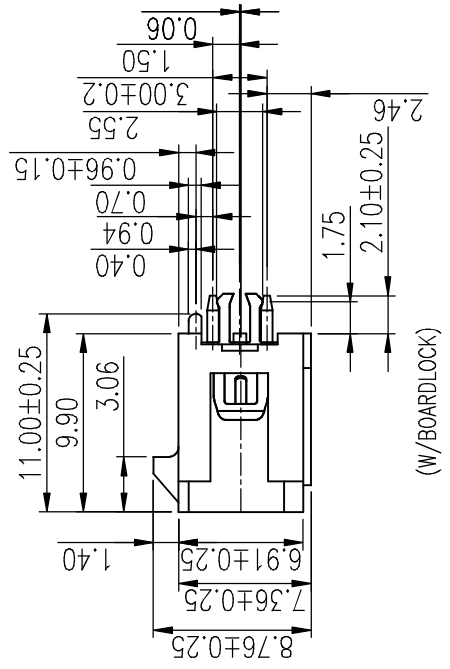
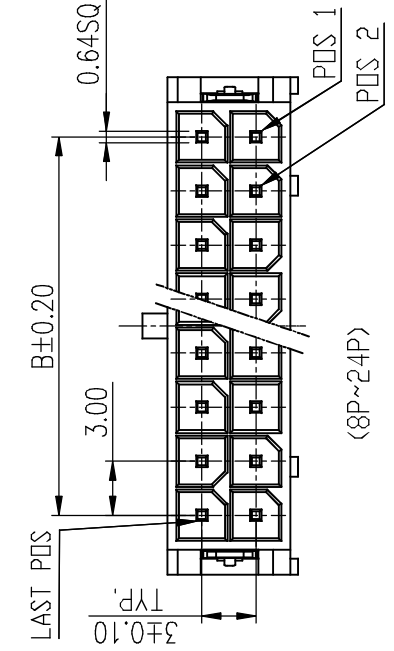
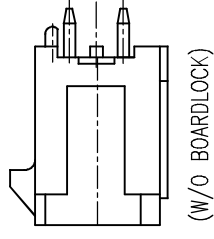

PART NO. G88MPXX1X2XXEU
 No. OF CIRCUIT → BOARD MOUNT OPTION
 C: W/BOARDLOCK
 D: W/O BOARDLOCK
 CONTACT FINISH → INSULATOR
 0: MATTE TIN (OVERALL) BLANK: LCP (BLACK)
 UNDER PLATING NICKEL 50 μ" THICKNESS MIN 1: LCP (NATURAL)
 2: 15 u" GOLD
 3: 30 u" GOLD

TOLERANCE	APPROVALS	DATE	TITLE
X.X ±0.30	DRAWN Debby Hung	02/10/2015	G88MP SEF
X.XX ±0.20	CHECKED Roger Tsai	02/10/2015	PLUS, WAFER
X.XXX ±0.10	APPROVED Arron Lin	02/10/2015	STRAIGHT D
ANGULAR ±1°	DWG TYPE CUST DWG	PROJECT CODE PHD	
UNLESS OTHERWISE SPECIFIED			

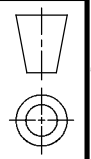

1 2 3 4 5 6

This document is the property of Amphenol Corporation and is delivered on the express condition that it is not to be disseminated or used, in whole or in part, for manufacture or assembly by anyone other than Amphenol Corporation without its prior consent, and that no right is granted to disclose or to use any information in this document.

The marking on this product doesn't contain environmental hazardous materials per Material Specification 35-00259 for Sony GP compliant or per directive 2011/65/EU for RoHS compliant.

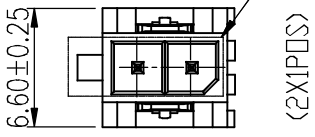

DETAIL D

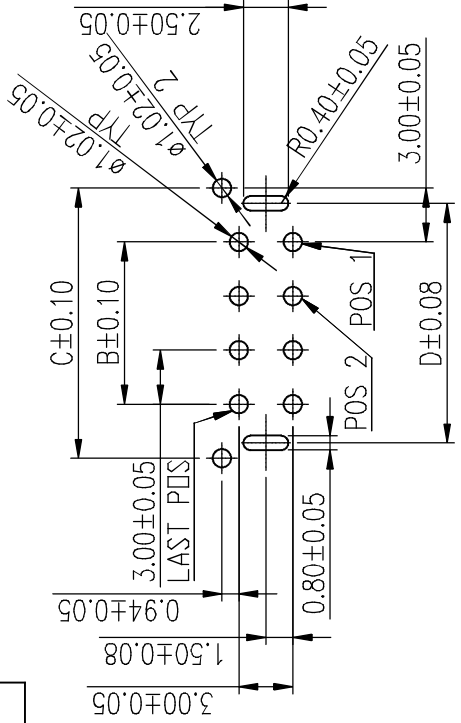
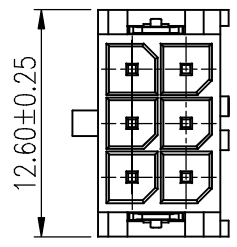
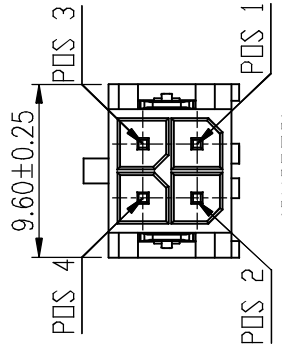

02~24P (W/BOARDLOCK)

RECOMMENDED PCB LAYOUT (T=1.60mm)

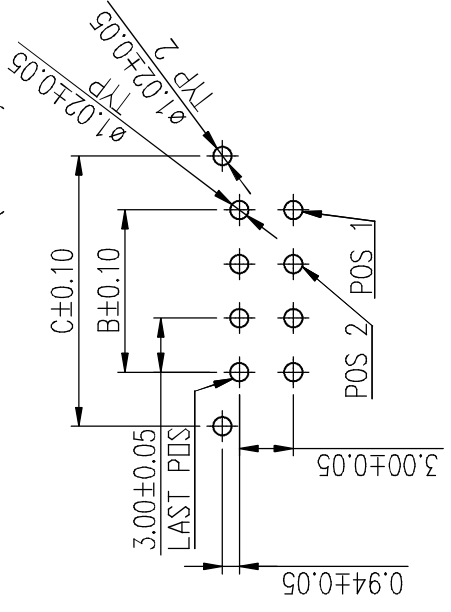

02~24P (W/O BOARDLOCK)

RECOMMENDED PCB LAYOUT (T=1.60mm)

TOLERANCE	APPROVALS	DATE	TITLE
X.X	DRAWN	02/10/2015	G88MP SEF PLUS, WAFER STRAIGHT D
X.X	DEBBY HUNG	02/10/2015	
X.XX	CHECKED	02/10/2015	
X.XXX	ROGER TSAI	02/10/2015	
ANGULAR ±1°	APPROVED	ARRON LIN	02/10/2015
UNLESS OTHERWISE SPECIFIED	DWG TYPE	CUST DWG	PROJECT CODE
			PHD

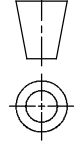

6

4

3

2

1

F

E

D

C

B

A

24 P

22 P

20 P

18 P

16 P

14 P

5

4

3

2

1

F

E

D

C

B

A

SYM

A

BX1

6

4

3

2

1

F

This document is the property of Amphenol Corporation and is delivered on the express condition that it is not to be disclosed, reproduced, used, in whole or in part for manufacture or sale by anyone other than Amphenol Corporation without its prior consent, and that no right is granted to disclose or to use any information in this document.

The marking on this product doesn't contain environmental hazardous materials per Material Specification: SS-00259 for Sony GP compliant or per directive 2011/65/EU for RoHS compliant.

POS.	BOARD-MOUNT P/N	CABLE HOUSING P/N	CABLE TERMINAL P/N	AWG NO.	PLATING OPTIONS
02	G88MP021X2XXEU	G88MPH0222CEU	G88MPCX232CEU	AWG#16~18	0: TIN 100u" ; 1: FLASH GOLD
			G88MPCX332CEU	AWG#20~30	2: 15u" GOLD ; 3: 30u" GOLD
04	G88MP041X2XXEU	G88MPH0422CEU	G88MPCX232CEU	AWG#16~18	0: TIN 100u" ; 1: FLASH GOLD
			G88MPCX332CEU	AWG#20~30	2: 15u" GOLD ; 3: 30u" GOLD
06	G88MP061X2XXEU	G88MPH0622CEU	G88MPCX232CEU	AWG#16~18	0: TIN 100u" ; 1: FLASH GOLD
			G88MPCX332CEU	AWG#20~30	2: 15u" GOLD ; 3: 30u" GOLD
08	G88MP081X2XXEU	G88MPH0822CEU	G88MPCX232CEU	AWG#16~18	0: TIN 100u" ; 1: FLASH GOLD
			G88MPCX332CEU	AWG#20~30	2: 15u" GOLD ; 3: 30u" GOLD
10	G88MP101X2XXEU	G88MPH1022CEU	G88MPCX232CEU	AWG#16~18	0: TIN 100u" ; 1: FLASH GOLD
			G88MPCX332CEU	AWG#20~30	2: 15u" GOLD ; 3: 30u" GOLD
12	G88MP121X2XXEU	G88MPH1222CEU	G88MPCX232CEU	AWG#16~18	0: TIN 100u" ; 1: FLASH GOLD
			G88MPCX332CEU	AWG#20~30	2: 15u" GOLD ; 3: 30u" GOLD
14	G88MP141X2XXEU	G88MPH1422CEU	G88MPCX232CEU	AWG#16~18	0: TIN 100u" ; 1: FLASH GOLD
			G88MPCX332CEU	AWG#20~30	2: 15u" GOLD ; 3: 30u" GOLD
16	G88MP161X2XXEU	G88MPH1622CEU	G88MPCX232CEU	AWG#16~18	0: TIN 100u" ; 1: FLASH GOLD
			G88MPCX332CEU	AWG#20~30	2: 15u" GOLD ; 3: 30u" GOLD
18	G88MP181X2XXEU	G88MPH1822CEU	G88MPCX232CEU	AWG#16~18	0: TIN 100u" ; 1: FLASH GOLD
			G88MPCX332CEU	AWG#20~30	2: 15u" GOLD ; 3: 30u" GOLD
20	G88MP201X2XXEU	G88MPH2022CEU	G88MPCX232CEU	AWG#16~18	0: TIN 100u" ; 1: FLASH GOLD
			G88MPCX332CEU	AWG#20~30	2: 15u" GOLD ; 3: 30u" GOLD
22	G88MP221X2XXEU	G88MPH2222CEU	G88MPCX232CEU	AWG#16~18	0: TIN 100u" ; 1: FLASH GOLD
			G88MPCX332CEU	AWG#20~30	2: 15u" GOLD ; 3: 30u" GOLD
24	G88MP241X2XXEU	G88MPH2422CEU	G88MPCX232CEU	AWG#16~18	0: TIN 100u" ; 1: FLASH GOLD
			G88MPCX332CEU	AWG#20~30	2: 15u" GOLD ; 3: 30u" GOLD

NOTE:
TO EN
ADOPT
(G88M
CABLE

TOLERANCE		APPROVALS		DATE	TITLE
X.X	±0.30	DRAWN	Debby Hung	02/10/2015	G88MP SER PLUS, WAFE STRAIGHT D
X.XX	±0.20	CHECKED	Roger Tsai	02/10/2015	
X.XXX	±0.10	APPROVED	Arron Lin	02/10/2015	
ANGULAR ±1°		DWG TYPE		CUST DWG	PROJECT CODE
UNLESS OTHERWISE SPECIFIED					PHD

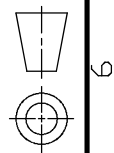

6

5

4

3

2

1

SYM
A
BK1 E

6

5

4

3

2

1

A

B

C

D

E

F

This document is the property of Amphenol Corporation and is delivered on the express condition that it is to be disclosed only to those individuals, departments or in part for manufacture or assembly by anyone other than Amphenol Corporation without its prior consent and that no right is granted to disclose or to use any information in this document.

The marking on this product doesn't contain environmental hazardous materials per Material Specification 35-00259 for Sony GP compliant or per directive 2011/65/EU for RoHS compliant.

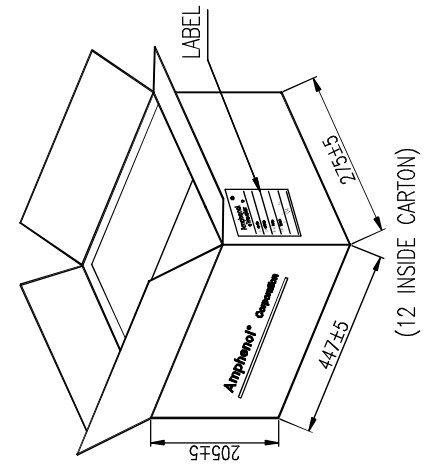
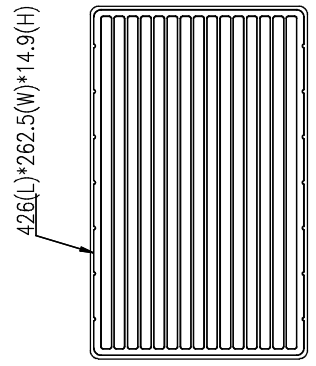
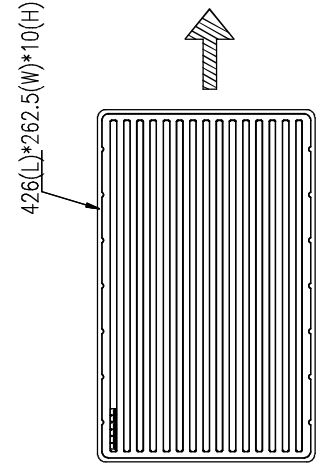

NOTE:

1. MATERIAL : BLACK CONDUCTIVE POLYSTYRENE ALLOY
2. ALL DIMENSIONS MEET EIA-481 -C REQUIREMENTS.
3. THICKNESS : 0.80±0.05mm.

TOLERANCE	APPROVALS	DATE	TITLE
X.X	DRAWN	02/10/2015	G88MP SEF
X.X	Debby Hung	02/10/2015	PLUS, WAF
X.XX	CHECKED	02/10/2015	STRAIGHT D
X.XXX	Roger Tsai	02/10/2015	
ANGULAR ±1°	APPROVED	02/10/2015	
UNLESS OTHERWISE SPECIFIED	ARRON LIN	PROJECT CODE	
	CUST DWG	PHD	

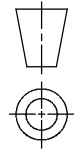

SYM
A
BK1

6
5
4
3
2
1

6

4

3

2

1

F

E

D

C

B

A

Looking for pricing, stock, or lifecycle information?

Click below to explore more details on WIN SOURCE:

- ⊖ [View G88MP20102CEU on WIN SOURCE](#)
- ⊖ [Amphenol Commercial Products Information](#)

Optimize Your Supply Chain with WIN SOURCE Solutions

- ✓ Global Sourcing Solution
- ✓ Obsolete Management
- ✓ Cost Control Management
- ✓ Shortage Management
- ✓ Alternative Solution
- ✓ Excess Inventory Management