

MODEL TL-5186

International size reference: ER22G75

TECHNICAL DATA

(Typical values @+25°C for batteries stored for one year or less)

■ Nominal capacity @ 0.5 mA, to 2V	0.40 Ah
■ Rated voltage	3.6 V
■ Weight	5.7g (0.201 oz)
■ Volume	1.35 cc
■ Operating temperature range	-55°C to +85°C
■ U.L. Component Recognition MH 12193	

TADIRAN LITHIUM BATTERIES

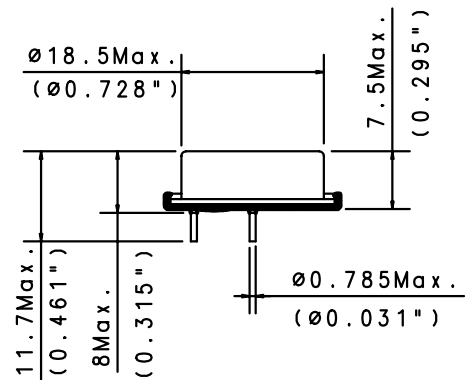
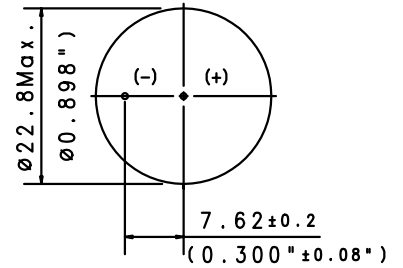

ADDITIONAL INFORMATION

SUFFIX - /P TIN PLATED NICKEL PINS
CATALOGUE NO.: 15-5186-43000

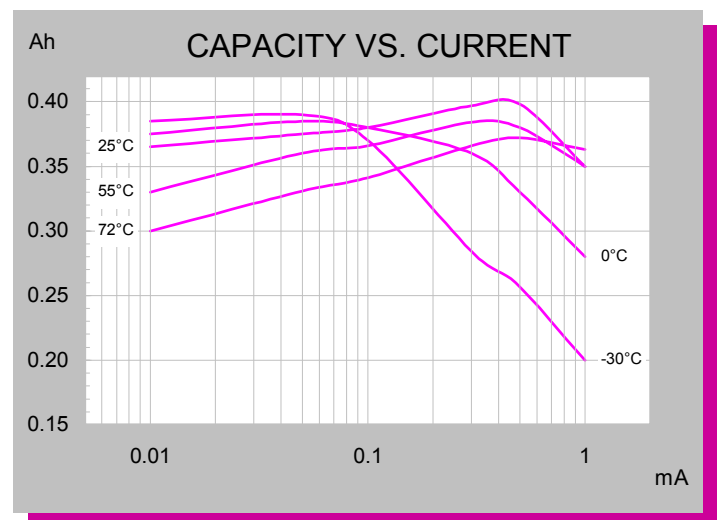
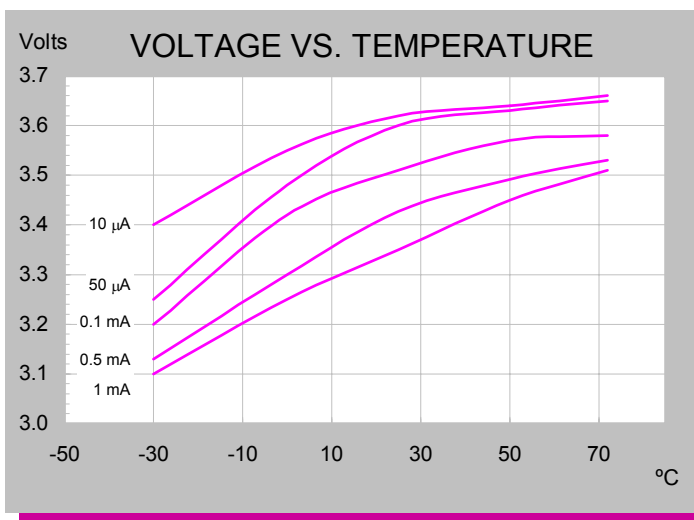
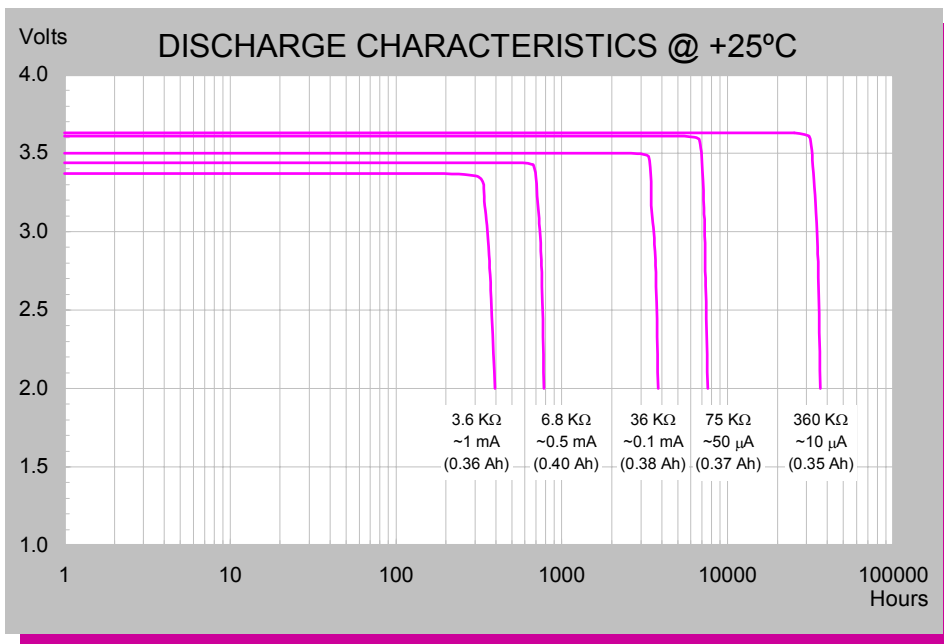

MEMORY BACKUP



Note: Any presentations in this data sheet concerning performance are for information purpose only and are not construed as warranties either expressed or implied, of future performance. Rev. D 05/03

Looking for pricing, stock, or lifecycle information?

Click below to explore more details on WIN SOURCE:

-  [View TL-5186 on WIN SOURCE](#)
-  [Tadiran Batteries](#) Information

Optimize Your Supply Chain with WIN SOURCE Solutions

-  Global Sourcing Solution
-  Obsolete Management
-  Cost Control Management
-  Shortage Management
-  Alternative Solution
-  Excess Inventory Management