



**THE DATASHEET OF
P1500SDLRP**



HF RoHS High Surge Current Series - DO-214



Agency Approvals

| Agency | Agency File Number |
|--------|--------------------|
| | E133083 |

Pinout Designation

Not Applicable

Schematic Symbol



Description

The High Surge Current DO-214 Series are SIDACtor® devices designed to protect equipment located in hostile environments from overvoltage transients.

The series provides a 200A 10/1000 μs rated surface mount solution that enables equipment to comply with enhanced surge requirements now specified in regulatory and customer requirements.

Features and Benefits

- Low voltage overshoot
- Low on-state voltage
- Does not degrade with use
- Fails short circuit when surged in excess of ratings
- 200A 10x1000 Surge Rating
- 1000A 2x10 Surge Rating

Applicable Global Standards

- TIA-968-A
- ITU K.20/21 Enhanced Level
- ITU K.20/21 Basic Level
- GR 1089 Inter-building
- GR 1089 Intra-building
- IEC 61000-4-5
- YD/T 1082
- YD/T 993
- YD/T 950

Electrical Characteristics

| Part Number | Marking | V_{DRM} @ $I_{DRM}=5\mu A$ | V_S @ 100V/μs | I_H | I_S | I_{T+} | V_T @ $I_T=2.2A$ | Capacitance @ 1MHz, 2V bias | |
|-------------|---------|---------------------------------|--------------------|--------|--------|----------|-----------------------|--------------------------------|--------|
| | | V min | V max | mA min | mA max | A max | V max | pf min | pF max |
| P0080SDLRP | P-8D | 6 | 25 | 50 | 800 | 2.2 | 4 | 50 | 150 |
| P0640SDLRP | P06D | 58 | 77 | 50 | 800 | 2.2 | 4 | 100 | 160 |
| P0720SDLRP | P07D | 65 | 88 | 50 | 800 | 2.2 | 4 | 100 | 150 |
| P0900SDLRP | P09D | 75 | 98 | 50 | 800 | 2.2 | 4 | 95 | 140 |
| P1100SDLRP | P11D | 90 | 130 | 50 | 800 | 2.2 | 4 | 75 | 115 |
| P1300SDLRP | P13D | 120 | 160 | 50 | 800 | 2.2 | 4 | 65 | 100 |
| P1500SDLRP | P15D | 140 | 180 | 50 | 800 | 2.2 | 4 | 60 | 90 |
| P1800SDLRP | P18D | 170 | 220 | 50 | 800 | 2.2 | 4 | 50 | 90 |
| P2300SDLRP | P23D | 190 | 260 | 50 | 800 | 2.2 | 4 | 50 | 80 |
| P2600SDLRP | P26D | 220 | 300 | 50 | 800 | 2.2 | 4 | 50 | 75 |
| P3100SDLRP | P31D | 275 | 350 | 50 | 800 | 2.2 | 4 | 45 | 70 |
| P3500SDLRP | P35D | 320 | 400 | 50 | 800 | 2.2 | 4 | 45 | 65 |

Notes:
 - Absolute maximum ratings measured at $T_A=25^\circ C$ (unless otherwise noted).
 - Devices are uni-directional
 ** Will meet 4.4A power cross requirement without fire hazard.

High Surge Current Series

Surge Ratings

| Series | I_{PP} | | | | | | | | | I_{TSM} 50/60 Hz | di/dt |
|--------|----------------------|-------------------|---------------------|---------------------|---------------------|--------------------|---------------------|----------------------|---------------------|-----------------------|----------|
| | 0.2x310 ¹ | 2x10 ¹ | 8x20 ¹ | 10x160 ¹ | 10x560 ¹ | 5x320 ¹ | 10x360 ¹ | 10x1000 ¹ | 5x310 ¹ | | |
| | 0.5x700 ² | 2x10 ² | 1.2x50 ² | 10x160 ² | 10x560 ² | 9x720 ² | 10x360 ² | 10x1000 ² | 10x700 ² | | |
| | A min | A min | A min | A min | A min | A min | A min | A min | A min | A min | A/μs max |
| D | — | 1000 | 800 | — | — | — | — | 200 | — | 50 | 1000 |

Notes:
 1 Current waveform in μs - Peak pulse current rating (I_{PP}) is repetitive and guaranteed for the life of the product.
 2 Voltage waveform in μs - I_{PP} ratings applicable over temperature range of -40°C to +85°C
 - The device must initially be in thermal equilibrium with -40°C ≤ T_J ≤ +150°C

Thermal Considerations

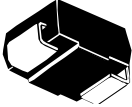
| Package | Symbol | Parameter | Value | Unit |
|-----------------------------------------------------------------------------------------------|-----------|-----------------------------------------|-------------|------|
| DO-214AA  | T_J | Operating Junction Temperature Range | -40 to +150 | °C |
| | T_S | Storage Temperature Range | -65 to +150 | °C |
| | $R_{θJA}$ | Thermal Resistance: Junction to Ambient | 90 | °C/W |

High Surge Current Series

V-I Characteristics

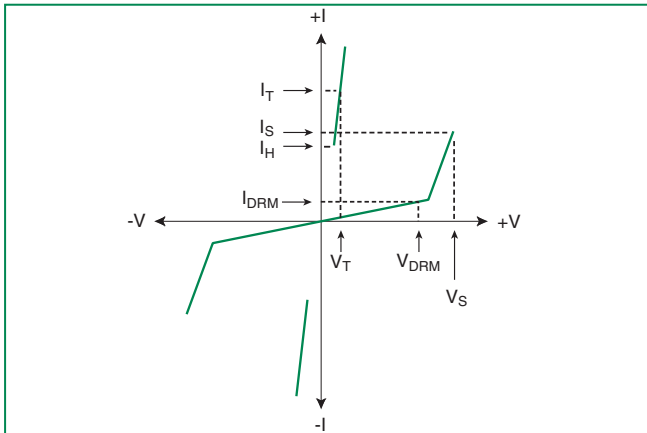

$t_r \times t_d$ Pulse Waveform

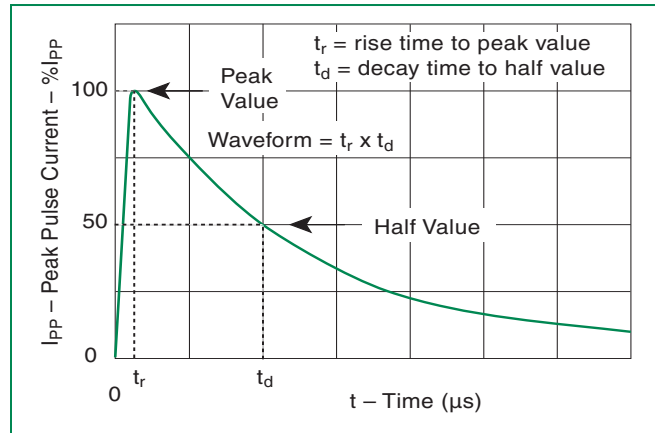

Normalized V_S Change vs. Junction Temperature

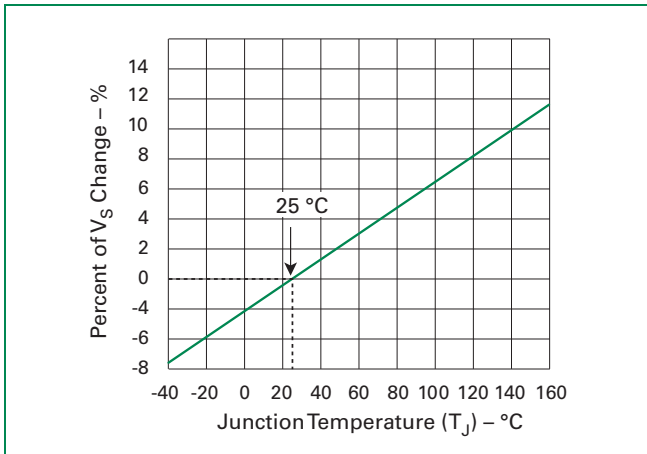

Normalized DC Holding Current vs. Case Temperature

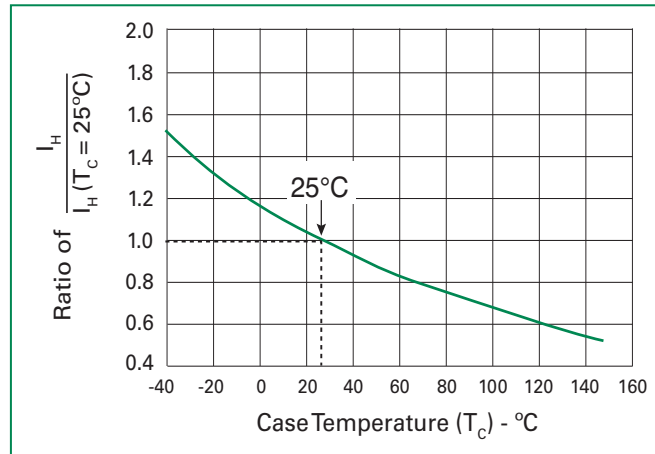

Soldering Parameters

| | | |
|-------------------------------------------------------|------------------------------------|-------------------------------|
| Reflow Condition | | Pb-Free assembly (see Fig. 1) |
| Pre Heat | - Temperature Min ($T_{s(min)}$) | +150°C |
| | - Temperature Max ($T_{s(max)}$) | +200°C |
| | - Time (Min to Max) (t_s) | 60-180 secs. |
| Average ramp up rate (LiquidusTemp (T_L) to peak) | | 3°C/sec. Max. |
| $T_{s(max)}$ to T_L - Ramp-up Rate | | 3°C/sec. Max. |
| Reflow | - Temperature (T_L) (Liquidus) | +217°C |
| | - Temperature (t_L) | 60-150 secs. |
| Peak Temp (T_p) | | +260(+0/-5)°C |
| Time within 5°C of actual Peak Temp (t_p) | | 30 secs. Max. |
| Ramp-down Rate | | 6°C/sec. Max. |
| Time 25°C to Peak Temp (T_p) | | 8 min. Max. |
| Do not exceed | | +260°C |

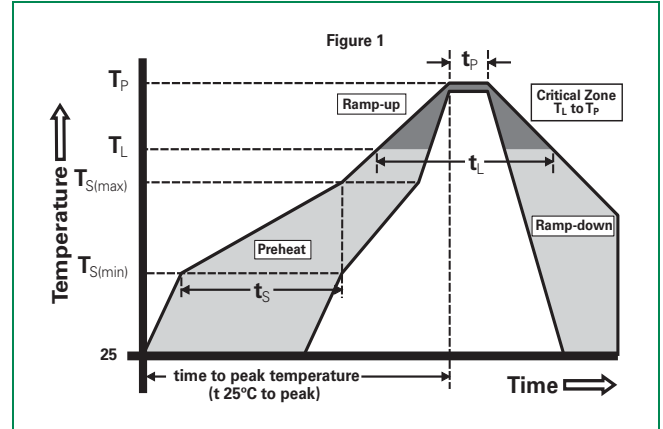

Physical Specifications

| | |
|------------------------|---------------------------------------------------------------|
| Lead Material | Copper Alloy |
| Terminal Finish | 100% Matte-Tin Plated |
| Body Material | UL recognized epoxy meeting flammability classification 94V-0 |

Environmental Specifications

| | |
|-----------------------------------------|-----------------------------------------------------------------------------------------------------------------------|
| High Temp Voltage Blocking | 80% Rated V_{DRM} (V_{AC} Peak) +125°C or +150°C, 504 or 1008 hrs. MIL-STD-750 (Method 1040) JEDEC, JESD22-A-101 |
| Temp Cycling | -65°C to +150°C, 15 min. dwell, 10 up to 100 cycles. MIL-STD-750 (Method 1051) EIA/JEDEC, JESD22-A-104 |
| Biased Temp & Humidity | 52 V_{DC} (+85°C) 85%RH, 504 up to 1008 hrs. EIA/JEDEC, JESD22-A-101 |
| High Temp Storage | +150°C 1008 hrs. MIL-STD-750 (Method 1031) JEDEC, JESD22-A-101 |
| Low Temp Storage | -65°C, 1008 hrs. |
| Thermal Shock | 0°C to +100°C, 5 min. dwell, 10 sec. transfer, 10 cycles. MIL-STD-750 (Method 1056) JEDEC, JESD22-A-106 |
| Autoclave (Pressure Cooker Test) | +121°C, 100%RH, 2atm, 24 up to 168 hrs. EIA/JEDEC, JESD22-A-102 |
| Resistance to Solder Heat | +260°C, 30 secs. MIL-STD-750 (Method 2031) |
| Moisture Sensitivity Level | 85%RH, +85°C, 168 hrs., 3 reflow cycles (+260°C Peak). JEDEC-J-STD-020, Level 1 |

Part Numbering

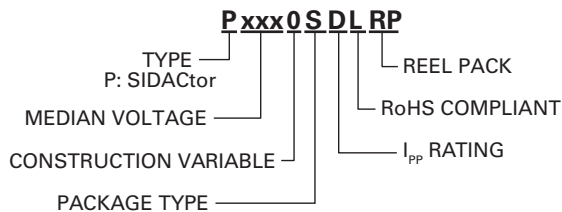

Part Marking

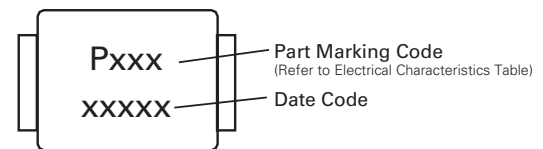

Dimensions — DO-214AA

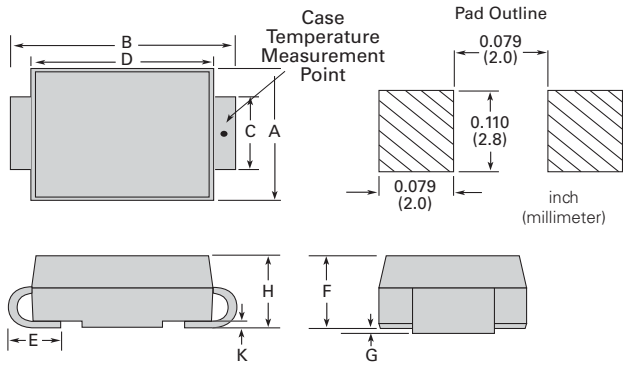

| Dimensions | Inches | | Millimeters | |
|------------|--------|-------|-------------|------|
| | Min | Max | Min | Max |
| A | 0.130 | 0.156 | 3.30 | 3.95 |
| B | 0.201 | 0.220 | 5.10 | 5.60 |
| C | 0.077 | 0.087 | 1.95 | 2.20 |
| D | 0.159 | 0.181 | 4.05 | 4.60 |
| E | 0.030 | 0.063 | 0.75 | 1.60 |
| F | 0.075 | 0.096 | 1.90 | 2.45 |
| G | 0.002 | 0.008 | 0.05 | 0.20 |
| H | 0.077 | 0.104 | 1.95 | 2.65 |
| K | 0.006 | 0.016 | 0.15 | 0.41 |

Packing Options

| Package Type | Description | Quantity | Added Suffix | Industry Standard |
|--------------|--------------------------------|----------|--------------|-------------------|
| S | DO-214AA Tape and Reel Pack | 2500 | RP | EIA-481-D |

Tape and Reel Specification — DO-214AA

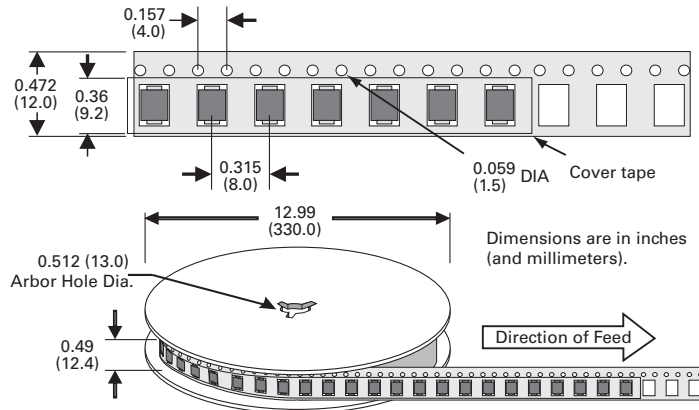

High Surge Current Series

Looking for pricing, stock, or lifecycle information?

Click below to explore more details on WIN SOURCE:

-  [View P1500SDLRP on WIN SOURCE](#)
-  [Littelfuse Inc. Information](#)

Optimize Your Supply Chain with WIN SOURCE Solutions

-  Global Sourcing Solution
-  Obsolete Management
-  Cost Control Management
-  Shortage Management
-  Alternative Solution
-  Excess Inventory Management