



**THE DATASHEET OF
FH41-50S-0.5SH(05)**



0.5mm Pitch, 2.5mm Height, shielded FFC Connectors for High Speed Transmissions

FH41 Series



Supports the next generation chip V-by-One® HS* by THine

*High speed serial interface technology for picture transmission



■ Features

1. Accepts impedance matched shielded FFC

The FH41 Series is equipped with a ground terminal and can be used with impedance matched shielded FFC.

2. Impedance matched terminal design

The signal terminal is designed for impedance control and is capable of handling high speed transmissions.

3. Highly reliable and secure structure

The design of the FH41 series follows in the footsteps of another popular Hirose connector, the FH28 series. The FFC positioning mechanism and rugged structure combine to prevent accidental unlocking and produce a secure connection.

4. Simplified operations with a flip lock system

The flip lock design allows a smoother simpler FFC operation. It requires less force to rotate the actuator and delivers a tactile click to reinforce that the lock has secured the connection.

5. Suitable for automatic pick-n-place mounting

Offered in tape and reel packaging that is compatible with automatic machine mounting. (2,500 pcs/reel)

6. Halogen free

All materials and substances used to produce this product comply with Halogen-free standards.

*Standards by IEC 61249-2-21. Br : 900 ppm or lower, Cl : 900 ppm or lower, Br+Cl : 1,500 ppm or lower

Dimensions: 68 positions

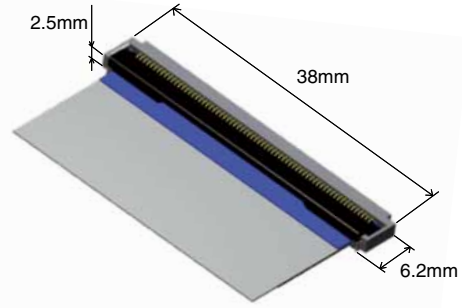

(Mounting area)

Fig.1

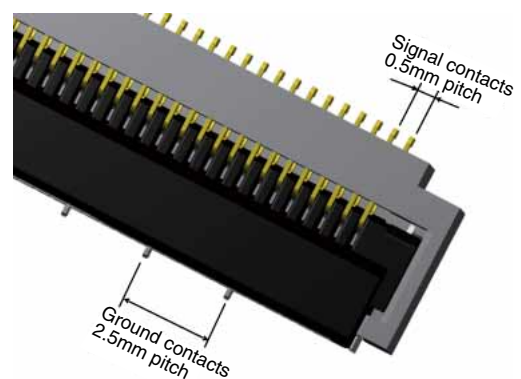

Fig.2

● Uses the same FFC that the FH48 Series (vertical connection) uses.



● Shielded FFC

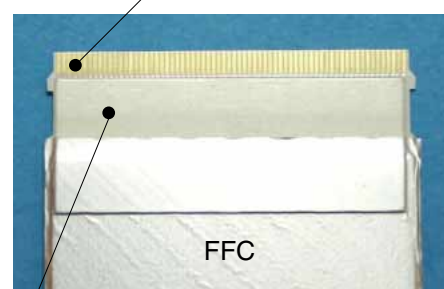

Fig.3

Product Specifications

Rating	Rated current 0.5A (Note 1) Rated voltage AC 50Vrms	Operating temperature range: -40 to +105°C (Note 2) Operating humidity range: Relative humidity of 90% or lower (no dew condensation)	Storage temperature range: -10 to +50°C (Note 3) Storage humidity range: Relative humidity of 90% or lower (no dew condensation)
Applicable FPC and FFC terminal specifications	t= 0.3 ±0.05, gold plating (GND plate: t= 0.5 ±0.05, tin plating)		
Items	Specifications	Conditions	
1. Insulation resistance	Minimum of 500MΩ	Measured at DC 100V.	
2. Withstanding voltage	No flashover or insulation damage	AC 150Vrms for 1 minute	
3. Contact resistance	Maximum of 100mΩ *Incl. FFC conductor resistance	Measured at 1mA.	
4. Repeated motions Durability	Contact resistance : Maximum of 100mΩ No damaged, cracked or loose parts.	20 mating cycles	
5. Vibration resistance	No electrical discontinuity for more than 1μs Contact resistance : Maximum of 100mΩ No damaged, cracked or loose parts.	Frequency 10 to 55Hz with half amplitude 0.75mm in 3 directions, 10 cycles each.	
6. Impact resistance	No electrical discontinuity for more than 1μs Contact resistance : Maximum of 100mΩ No damaged, cracked or loose parts.	Acceleration : 981m/s ² , duration time : 6ms, with half sine waves in 3 directions, three times each.	
7. Humidity resistance in ordinary conditions	Contact resistance : Maximum of 100mΩ Insulation resistance : Minimum of 50MΩ No damaged, cracked or loose parts.	Left for 96 hours at temperature 40°C, humidity 90 to 95%	
8. Temperature cycle	Contact resistance : Maximum of 100mΩ Insulation resistance : Minimum of 50MΩ No damaged, cracked or loose parts.	Temperature : -40°C → +15°C to +35°C → +105°C → +15°C to +35°C Time : 30 → 2 to 3 → 30 → 2 to 3 min. 5 cycles in the above conditions	
9. Solder heat resistance	No deformation of components or no significant looseness of contacts, etc.	Reflow : Recommended temperature profile Manual soldering : 350 ±5°C for 5 sec.	

Note 1 : When energizing rated current to all contacts, use 70% of rated current.

Note 2 : Includes temperature rise caused by current flow.

Note 3 : The term "storage" here refers to products stored for a long period prior to board mounting and use. The operating temperature and humidity range covers the non-energized condition of connectors after board mounting and the temporary storage.

Materials / Finish

Parts	Materials	Color/Finish	Remarks
Insulating parts	LCP	Gray	UL94V-0
		Black	
Terminal	Phosphor bronze	Gold plating	—
		Pure tin reflow plating	
Metal parts	Phosphor bronze (plating material)		

Product number structure

Refer to the chart below when determining the product specifications from the product number. Please select from the product numbers listed in this catalog when placing orders.

FH 41 - 50S - 0.5 SH (05)

① ② ③ ④ ⑤ ⑥

① Series name : FH	⑤ Terminal shape SH...SMT horizontal implementation type
② Series number : 41	
③ Number of contacts : 15 to 68	
④ Contact pitch : 0.5mm	
⑥ Plating specifications : (05)...Gold plating (Except 50, 68 contacts) (28)...Gold plating (50, 68 contacts)	

■ Connector dimension drawing

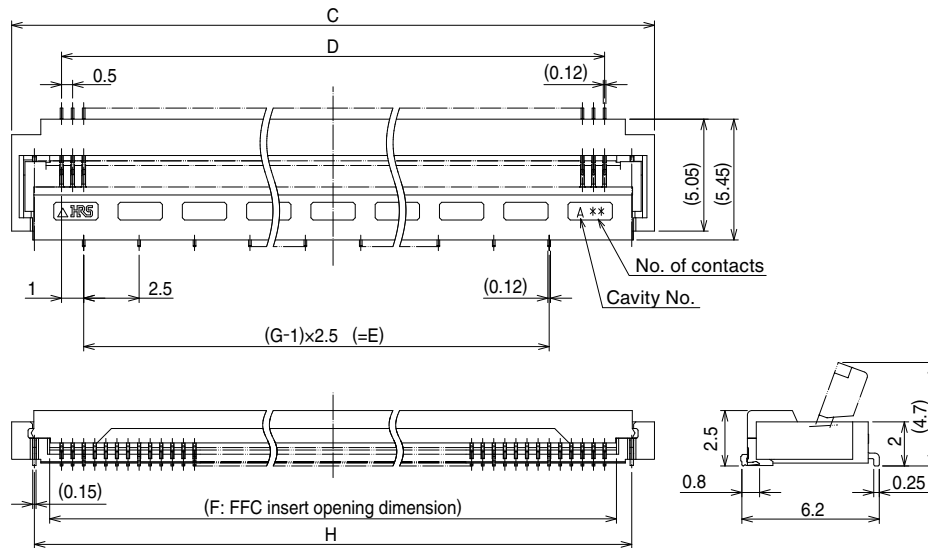

Note 1 : The coplanarity of the metal fittings and the contacts are a maximum of 0.1mm.

Note 2 : Packaged on tape and reel only. Check packaging specification.

Note 3 : Recesses may be added to the part structure to improve the molding characteristics. Black marks may appear in the mold resin, but they will not negatively affect the performance of these connectors.

Note 4 : The color of the plating may change after the reflow process, but it will not negatively affect the performance of these connectors.

■ Connector dimension table

Unit : mm

Part No.	HRS No.	No. of contacts	Number of ground contacts : G	C	D	E	F	H
FH41-15S-0.5SH(05)	580-2222-2 05	15	3	11.5	7	5	8.07	9.45
FH41-20S-0.5SH(05)	580-2221-0 05	20	4	14	9.5	7.5	10.57	11.95
FH41-28S-0.5SH(05)	580-2208-1 05	28	5	18	13.5	10	14.57	15.95
FH41-30S-0.5SH(05)	580-2218-5 05	30	6	19	14.5	12.5	15.57	16.95
FH41-31S-0.5SH(05)	580-2216-0 05	31	6	19.5	15	12.5	16.07	17.45
FH41-40S-0.5SH(05)	580-2205-3 05	40	8	24	19.5	17.5	20.57	21.95
FH41-50S-0.5SH(28)	580-2204-0 28	50	10	29	24.5	22.5	25.57	26.95
FH41-60S-0.5SH(05)	580-2223-0 05	60	12	34	29.5	27.5	30.57	31.95
FH41-68S-0.5SH(28)	580-2202-5 28	68	13	38	33.5	30	34.57	35.95

Note 1 : This embossed packaged product is sold by full reel quantities of 2,500 pcs/reel. Please place orders in full reel quantities.

Recommended PCB layout and metal mask dimension diagram

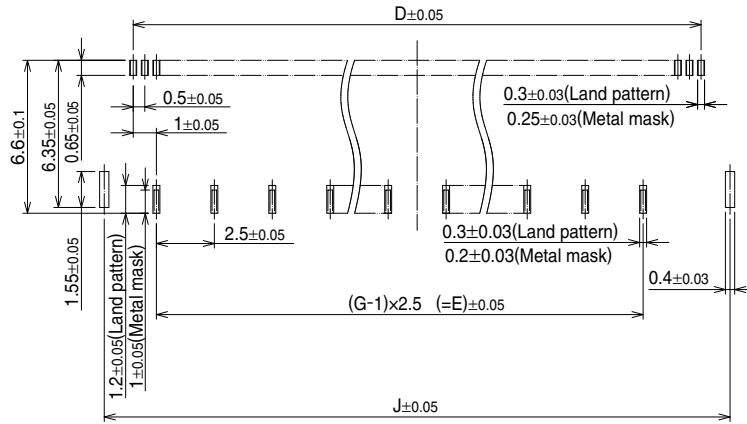

Recommended metal mask thickness : t= 0.1

Recommended FFC dimension drawing

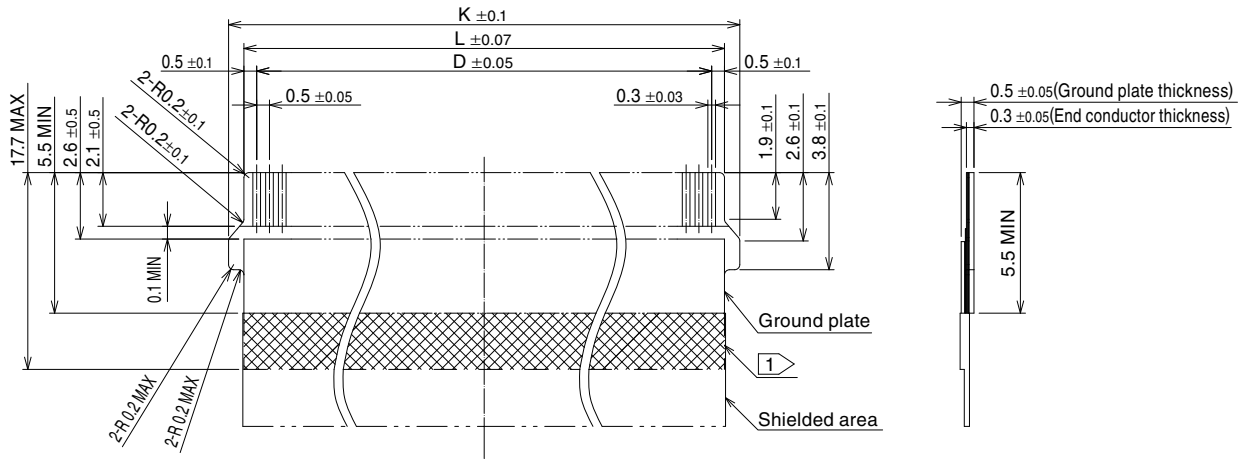

Note : 1 Please overlap shield plate on ground plate

Recommended land, metal mask and FFC dimension table

Unit : mm

Part No.	HRS No.	No. of contacts	Number of ground contacts : G	J	K	L
FH41-15S-0.5SH(05)	580-2222-2 05	15	3	9.5	9.2	8
FH41-20S-0.5SH(05)	580-2221-0 05	20	4	12	11.7	10.5
FH41-28S-0.5SH(05)	580-2208-1 05	28	5	16	15.7	14.5
FH41-30S-0.5SH(05)	580-2218-5 05	30	6	17	16.7	15.5
FH41-31S-0.5SH(05)	580-2216-0 05	31	6	17.5	17.2	16
FH41-40S-0.5SH(05)	580-2205-3 05	40	8	22	21.7	20.5
FH41-50S-0.5SH(28)	580-2204-0 28	50	10	27	26.7	25.5
FH41-60S-0.5SH(05)	580-2223-0 05	60	12	32	31.7	30.5
FH41-68S-0.5SH(28)	580-2202-5 28	68	13	36	35.7	34.5

◆ Packaging Specifications

● Embossed carrier tape dimension

(Tape width: Maximum of 24mm)

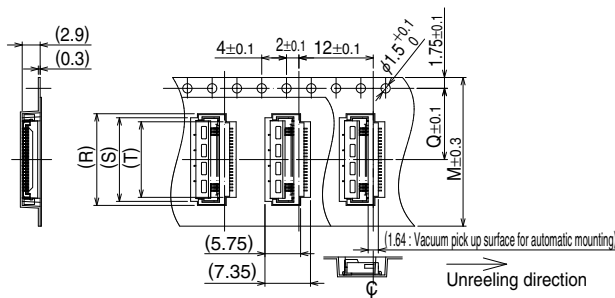

(Tape width: Minimum of 32mm)

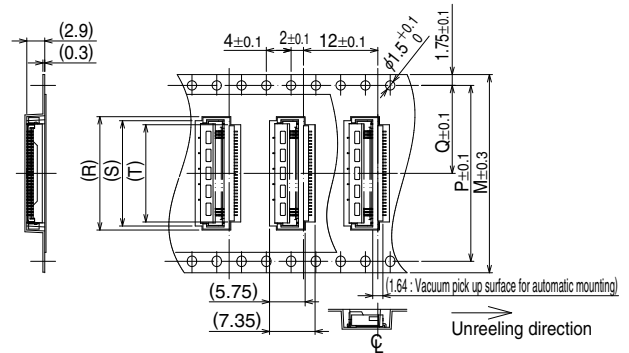

● Reel dimensions

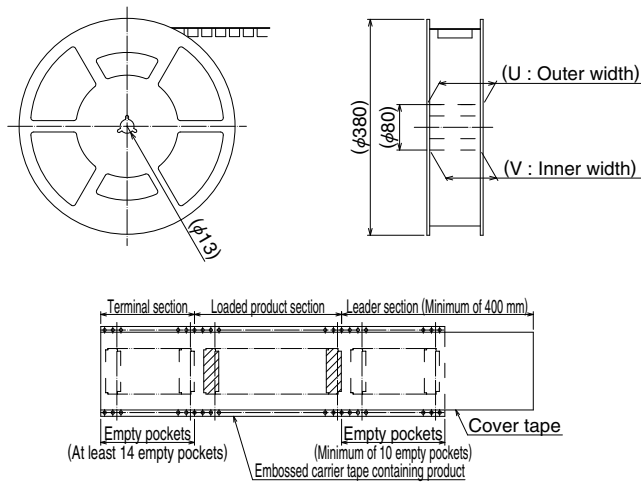

◆ Packaging Specification Dimensions

Unit : mm

Part No.	HRS No.	No. of contacts	Number of ground contacts : G	M	P	Q	R	S	T	U	V
FH41-15S-0.5SH(05)	580-2222-2 05	15	3	24	-	11.5	11.8	10.5	9.2	29.4	25.4
FH41-20S-0.5SH(05)	580-2221-0 05	20	4		-		14.3	13.5	12.2		
FH41-28S-0.5SH(05)	580-2208-1 05	28	5	32	28.4	14.2	18.3	17	15.7	37.4	33.4
FH41-30S-0.5SH(05)	580-2218-5 05	30	6				19.3	18	16.7		
FH41-31S-0.5SH(05)	580-2216-0 05	31	6	44	40.4	20.2	19.8	18.5	17.2	49.4	45.4
FH41-40S-0.5SH(05)	580-2205-3 05	40	8				24.3	23	21.7		
FH41-50S-0.5SH(28)	580-2204-0 28	50	10	56	52.4	26.2	29.3	28	26.7	61.4	57.4
FH41-60S-0.5SH(05)	580-2223-0 05	60	12				34.3	33	31.7		
FH41-68S-0.5SH(28)	580-2202-5 28	68	13				38.3	37	35.7		

◆ FH41 Series FFC materials configuration (recommended specifications)

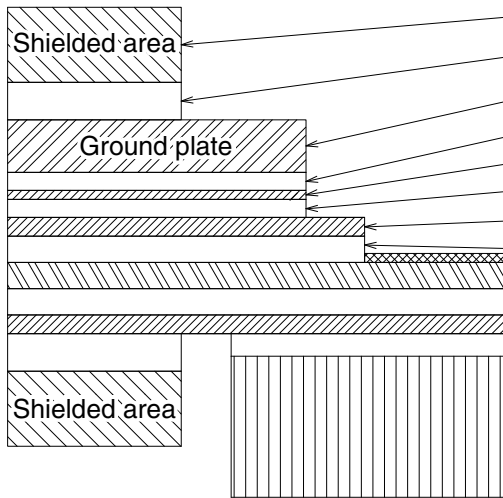

Material name	Materials	Total Thickness at Ground Plate (μm)	Total Thickness at End Conductor (μm)
Shielding Material			
Conductive Adhesive	Polyester Type		
Copper Foil (Tin plating)		70	①
Adhesive	Acrylic Type	24	①
Base Film	Polyester Type	12	①
Adhesive	Acrylic Type	24	①
Insulation Layer	Polyester Type	25	
Adhesive	Polyester Type	35	
Soft Copper Foil (Nickel Under Plating + Gold Plating)		35	35
Adhesive	Polyester Type	35	35
Insulation Layer	Polyester Type	25	25
Adhesive	Polyester Type	30	30
Stiffener	Polyester Type	188	188
Total		503	313

① Contact us with inquiries on how to change the specifications and thickness configurations.

◆ Recommended Soldering Profile

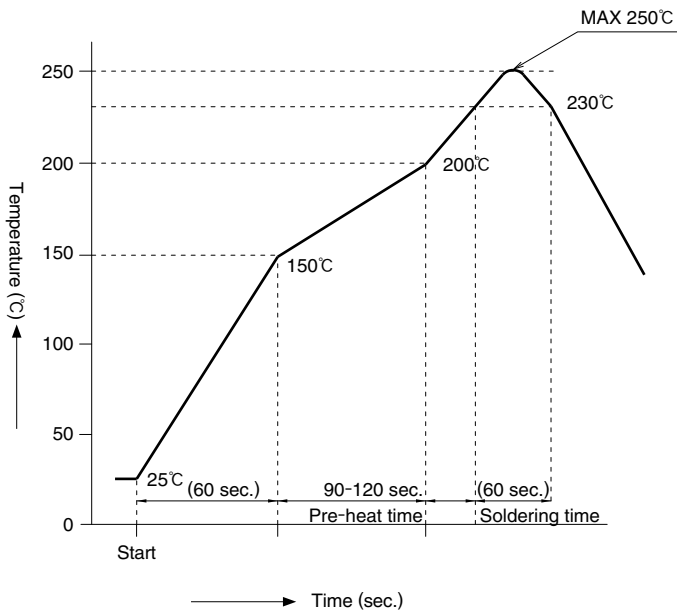

Application conditions



- Reflow type : Reflow with far-infrared ray and hot air combined
- Reflow furnace atmosphere: Air
- Solder : Cream type Sn/3.0 Ag/0.5 Cu (Senju Metal Industry, M705-221CM5-42-10.5)
- Test board : Board material and size
Glass epoxy 30×60×0.8mm
Land dimension 0.3×0.65, 0.3×1.2mm
- Metal mask : Thickness 0.1mm
Opening dimensions 0.25×0.65, 0.2×1mm

This temperature profile shall be used under the above application conditions.





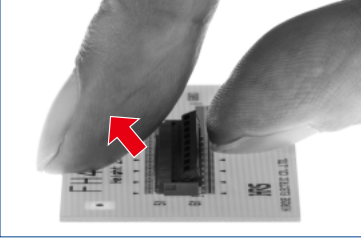
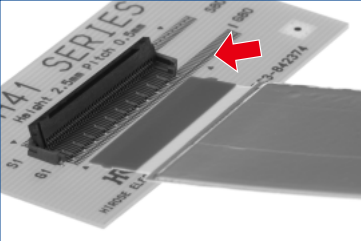

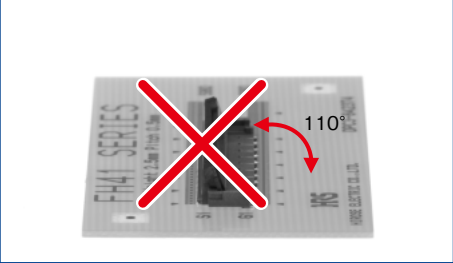
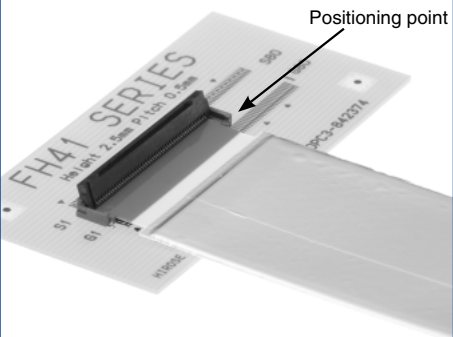
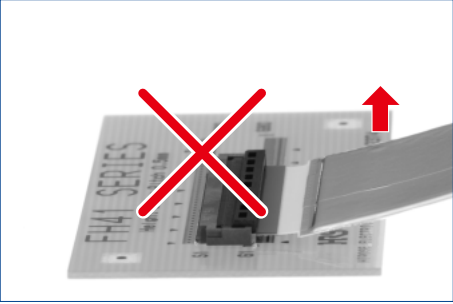
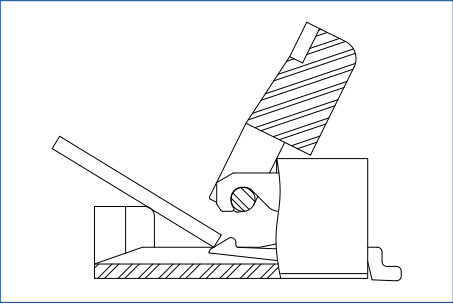
This temperature profile is based on the conditions provided above.

Please check the mounting conditions before use, conditions such as solder paste types, manufacturer, PCB size and any other soldering materials may alter the performance of such materials.

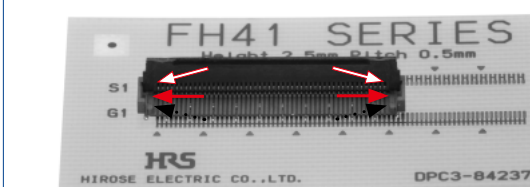
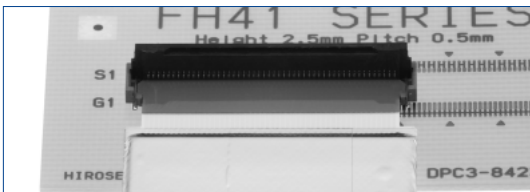
◆ Connector handling and precautions

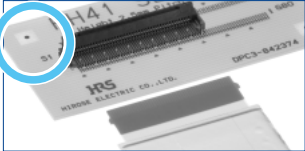
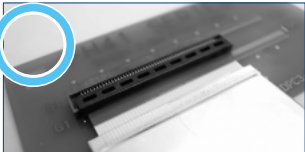
Connector handling	Precautions for use
<p>1. Insertion of FFC</p> <p>① Rotate the actuator upward to unlock it. The actuator can be easily operated with the use of a thumb nail or index finger.</p>  <p>② Insert the FFC into the connector with the conductive traces facing down. The FFC should be inserted at a slight oblique angle relative to the mounting surface, for more directions please refer to the next page.</p>  <p>③ Rotate the actuator down until it is firmly closed.</p>  <p>2. FFC removal</p> <p>① Rotate the actuator upwards to release the lock, then lift up the FFC and remove it from the connector.</p> 	<p>① The FH41 series actuator was designed to open up to a maximum angle of 110°, forcing the actuator past this point will damage or detach it. Do not apply excessive force when rotating the actuator.</p>  <p>② Insert the FFC correctly into the opening, failing to do so can lead to disconnection or conduction failure.</p>  <p>③ The connector's design is not resistant against upward pulling forces. The FFC should be fixed so that the pull force is not transmitted to the connector.</p>  <p>④ Be careful not to scrape the FFC on the housing of the connector during insertion, this action can lead to damaged contacts, terminal deformation, FFC conductor defects and other failures.</p> 

◆ Precautions for inserting and mating FFC with positioning tabs

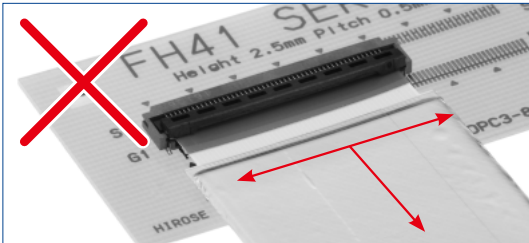
Handling	Precautions for use
<p>1. Insertion position Insert the cable so that the positioning tabs lay in the gap, which is indicated by the two →, between the mold wall on the both sides of the cable insert opening indicated by ···▶ and the guide wall that is on the inside of the connector indicated by ⇨.</p>   <p>2. Precautions for insertion and mating</p> <p>❶ Do not insert the cable diagonally, the corners of the cable might get hooked on the connector which can damage the contacts.</p> <p>Insertion from a skewed direction</p>  <p>Recommended mating</p>  <p>❶ Insert the cable straight into the opening at a slight angle to ensure a complete connection.</p>  <p>❷ Rotate the actuator down to close the actuator.</p>	<p>❷ FFC must not over lap Do not close the actuator until the FFC has been placed into its correct position. If it is sitting on the guides and the actuator closes onto it, it can cause damage and alter its performance.</p> <p>Cable over lapping on the left guide.</p>  <p>Cable over lapping on the right guide.</p>  <p>Correct insertion</p>  <p>Do not close the actuator if the cable is not in its correct position or if it is still on top of the guides.</p>  <p>If the lock is closed with the cable running over the guide, do not move the cable. In this case, open the actuator first and re-insert the cable to the position explained in "1. Insertion position." In the event that the lock is closed and the cable was not in its correct position, do not try to move the cable. Release the lock immediately and open the actuator back up, remove and re-position the cable as explained previously in "1. Insertion position."</p> <p>Prevent the actuator from closing and moving in various directions with the cable running over the guide. If the cable is misplaced and the actuator is closed, do not move the cables back and forth after the actuator has been locked.</p> 

Aug. 1.2019 Copyright 2019 HIROSE ELECTRIC CO., LTD. All Rights Reserved.



HIROSE ELECTRIC CO.,LTD.

2-6-3,Nakagawa Chuoh,Tsuzuki-Ku,Yokohama-Shi 224-8540,JAPAN
 TEL: +81-45-620-3526 Fax: +81-45-591-3726
<http://www.hirose.com>
<http://www.hirose-connectors.com>

Looking for pricing, stock, or lifecycle information?

Click below to explore more details on WIN SOURCE:

-  [View FH41-50S-0.5SH\(05\) on WIN SOURCE](#)
-  [Hirose Electric Co Ltd Information](#)

Optimize Your Supply Chain with WIN SOURCE Solutions

-  Global Sourcing Solution
-  Obsolete Management
-  Cost Control Management
-  Shortage Management
-  Alternative Solution
-  Excess Inventory Management