



**THE DATASHEET OF  
FH34SRJ-24S-0.5SH(99)**



# 0.5mm Pitch, 1.0mm above the board Top and Top/Bottom Contact, Back-Flip Actuator Flexible Printed Circuit & Flexible Flat Cable ZIF Connectors

## FH34SRJ Series

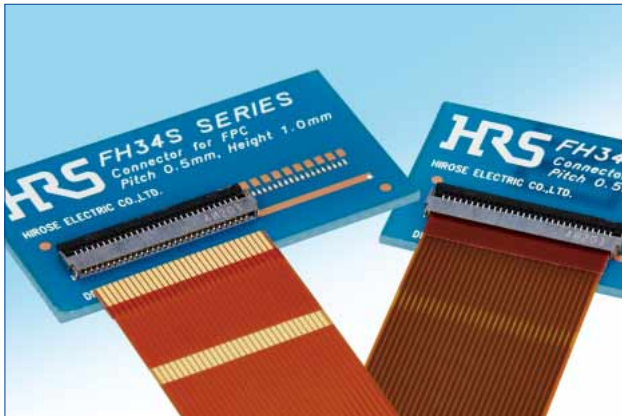

### ●3.8mm Depth

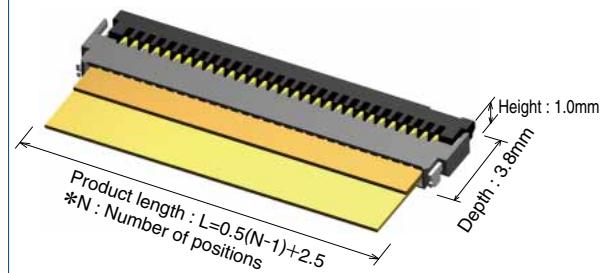

Fig.1

## ■Features

### 1. Low-profile

With the 1.0mm above the board and width of 3.8mm the connectors are used in space saving applications.

### 2. Increased FPC/FFC retention

As compared with existing similar construction connectors :

- \* In horizontal direction : Approximately 2.6 times higher
- \* In vertical direction : Approximately 2 times higher

### 3. Unique Back-Flip rotating actuator

The rotating actuator opens from the back of the connector, assuring reliable electrical and mechanical connection.

### 4. Easy FPC insertion and reliable electrical connection

Proven Flip Lock actuator allows easy insertion of FPC and provides a tactile sensation when fully closed, confirming complete electrical and mechanical connection.

### 5. Delivered with the actuator open

FPC/FFC can be immediately inserted without the need for the opening of the actuator.

### 6. Accepts standard FPC thickness

0.3mm thick standard Flexible Printed Circuit (FPC) can be used. This is the only ultra-low profile ZIF connector using standard FPC.

### 7. Conductive traces on the PCB can run under the connector

No exposed contacts on the bottom of the connector.

### 8. Halogen-free\*

- \*As defined by IEC61249-2-21
- Br-900ppm maximum, Cl-900ppm maximum,
- Cl + Br combined-1,500ppm maximum

### 9. Board placement with automatic equipment

Flat upper surface and tape and reel packaging facilitate vacuum pick-up and placement. Standard reel packaging contains 5000 connectors.

### ●Top/Bottom Contact

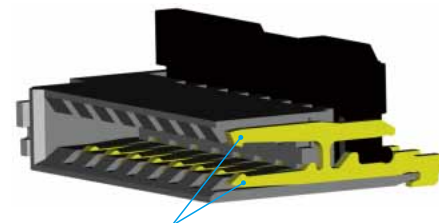

Fig.2

### ●FH34SRJ Differential Impedance

130ps rise time (20-80%)

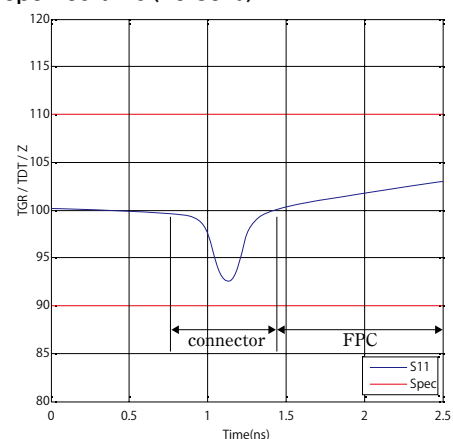

Fig.3

### ●Smooth FPC / FFC insertion

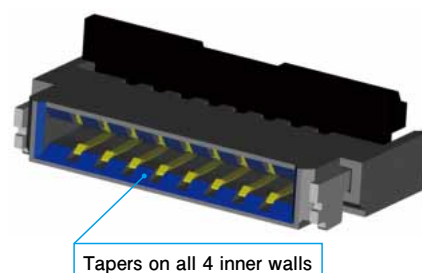

Fig.4

## Product Specifications

Ratings	Current rating 0.5A (Note 1) Voltage rating 50Vrms AC	Operating temperature range : -55 to +85°C (Note 2) Operating humidity range : Relative humidity 90% max. (No condensation)	Storage temperature range : -10 to +50°C (Note 3) Storage humidity range : Relative humidity 90% max. (No condensation)
---------	--	--	--

Recommended FPC/FFC	Thickness : 0.3 ± 0.03 mm, Gold plated contact pads
---------------------	---

Item	Specification	Conditions
1. Insulation resistance	500MΩ min.	100V DC
2. Withstanding voltage	No flashover or insulation breakdown	250Vrms AC / 1 minute
3. Contact resistance	100mΩ max. * Including FPC and FFC conductor resistance	1mA, AC / DC 20mV max (AC : 1kHz)
4. Durability	Contact resistance : 100mΩ max. No damage, cracks, or parts dislocation	20cycles
5. Vibration	No electrical discontinuity of 1μs or longer Contact resistance : 100mΩ max. No damage, cracks, or parts dislocation	Frequency : 10 to 55 Hz, single amplitude of 0.75 mm, 10 cycles in each of the 3 axis
6. Shock	No electrical discontinuity of 1μs or longer Contact resistance : 100mΩ max. No damage, cracks, or parts dislocation	Acceleration of 981m/s <sup>2</sup> , 6 ms duration, sine half-wave, 3 cycles in each of the 3 axis
7. Humidity (Steady state)	Contact resistance : 100mΩ max. Insulation resistance : 50MΩ min. No damage, cracks, or parts dislocation	96 hours at 40°C and humidity of 90 to 95%
8. Temperature cycle	Contact resistance : 100mΩ max. Insulation resistance : 50MΩ min. No damage, cracks, or parts dislocation	Temperature : -55°C → +15°C to +35°C → +85°C → +15°C to +35°C Time: 30 → 2 to 3 → 30 → 2 to 3 minutes 5 cycles
9. Resistance to soldering heat	No deformation of components affecting performance	Reflow : At the recommended temperature profile Manual soldering: 350°C ±10°C for 5 seconds (Note 3)

Note1 : When passing the current through all of the contacts, use 70% of the rated current.

Note2 : Includes temperature rise caused by current flow.

Note3 : The term "storage" refers to products stored for a long period prior to mounting and use.

The operating temperature and humidity range covers the non-conducting condition of installed connectors in storage, shipment or during transportation after board mounting.

## Materials / Finish

Part	Material	Finish	Remarks
Insulator	LCP	Color : Gray	UL94V-0
	PA	Color : Black	
	LCP(8pos.)		
Contacts	Phosphor bronze	Gold plating with nickel barrier	————
Metalfittings	Phosphor bronze	Pure tin reflow plating	————

## Product Number Structure

Refer to the chart below when determining the product specifications from the product number.

Please select from the product numbers listed in this catalog when placing orders.

**FH**   **34S**   **RJ**   -   **30S**   -   **0.5**   **SH**   **(50)**  

①
②
③
④
⑤
⑥
⑦

① Series name : FH	⑤ Contact pitch : 0.5mm
② Series No. : 34S	⑥ Termination type SH : SMT horizontal mounting type
③ RJ : Top and Bottom contact, halogen-free (Flame retardance UL94V-0).	⑦ Specifications (50)...Standard product 5,000 pcs/reel (99)...500 pcs/reel
④ Number of Contacts : 4 to 50	

## Connector Dimensions

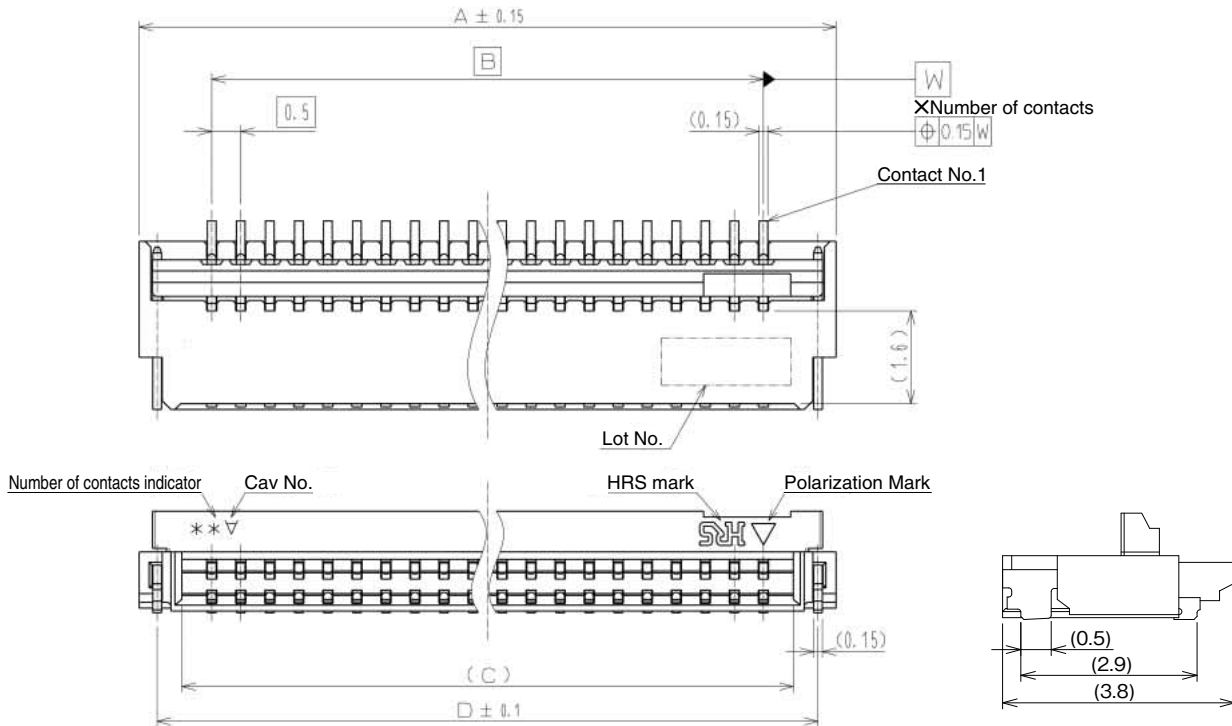

Note 1 : The coplanarity of each terminal lead within specified dimension is 0.1mm Max.

Note 2 : Packaged on tape and reel only. Check packaging specification.

Note 3 : Slight variations in color of the plastic compounds do not affect form, fit or function of the connector.

Note 4 : After reflow, the terminal plating may change color, however this does not represent a quality issue.

Unit : mm

Part No.	HRS No.	No. of Contacts	A	B	C	D
FH34SRJ-4S-0.5SH(50)	580-1238-7 50	4	4	1.5	2.53	3.38
FH34SRJ-5S-0.5SH(50)	580-1264-7 50	5	4.5	2	3.03	3.88
FH34SRJ-6S-0.5SH(50)	580-1236-1 50	6	5	2.5	3.53	4.38
FH34SRJ-7S-0.5SH(50)	580-1200-0 50	7	5.5	3	4.03	4.88
FH34SRJ-8S-0.5SH(50)	580-1231-8 50	8	6	3.5	4.53	5.38
FH34SRJ-9S-0.5SH(50)	580-1262-1 50	9	6.5	4	5.03	5.88
FH34SRJ-10S-0.5SH(50)	580-1251-5 50	10	7	4.5	5.53	6.38
FH34SRJ-11S-0.5SH(50)	580-1258-4 50	11	7.5	5	6.03	6.88
FH34SRJ-12S-0.5SH(50)	580-1253-0 50	12	8	5.5	6.53	7.38
FH34SRJ-14S-0.5SH(50)	580-1252-8 50	14	9	6.5	7.53	8.38
FH34SRJ-16S-0.5SH(50)	580-1259-7 50	16	10	7.5	8.57	9.38
FH34SRJ-18S-0.5SH(50)	580-1248-0 50	18	11	8.5	9.57	10.38
FH34SRJ-20S-0.5SH(50)	580-1256-9 50	20	12	9.5	10.57	11.38
FH34SRJ-22S-0.5SH(50)	580-1254-3 50	22	13	10.5	11.57	12.38
FH34SRJ-24S-0.5SH(50)	580-1255-6 50	24	14	11.5	12.57	13.38
FH34SRJ-26S-0.5SH(50)	580-1247-8 50	26	15	12.5	13.57	14.38
FH34SRJ-30S-0.5SH(50)	580-1232-0 50	30	17	14.5	15.57	16.38
FH34SRJ-34S-0.5SH(50)	580-1261-9 50	34	19	16.5	17.53	18.38
FH34SRJ-40S-0.5SH(50)	580-1260-6 50	40	22	19.5	20.53	21.38
FH34SRJ-45S-0.5SH(50)	580-1265-0 50	45	24.5	22	23.03	23.88
FH34SRJ-50S-0.5SH(50)	580-1266-2 50	50	27	24.5	25.53	26.38

Tape and reel packaging.

Order by number of reels.

## Recommended PCB mounting pattern and metal mask dimensions

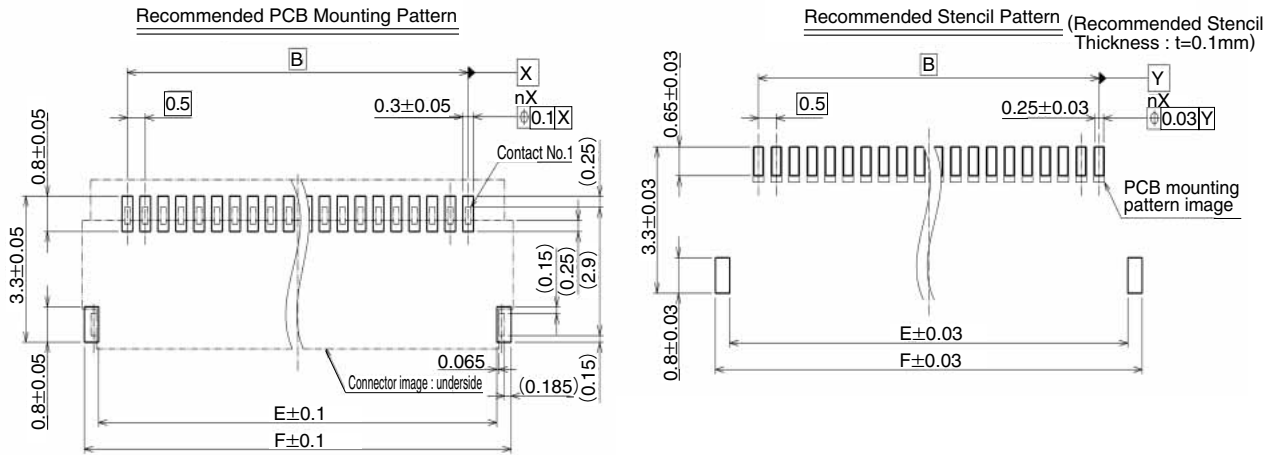

## Recommended FPC/FFC Dimensions

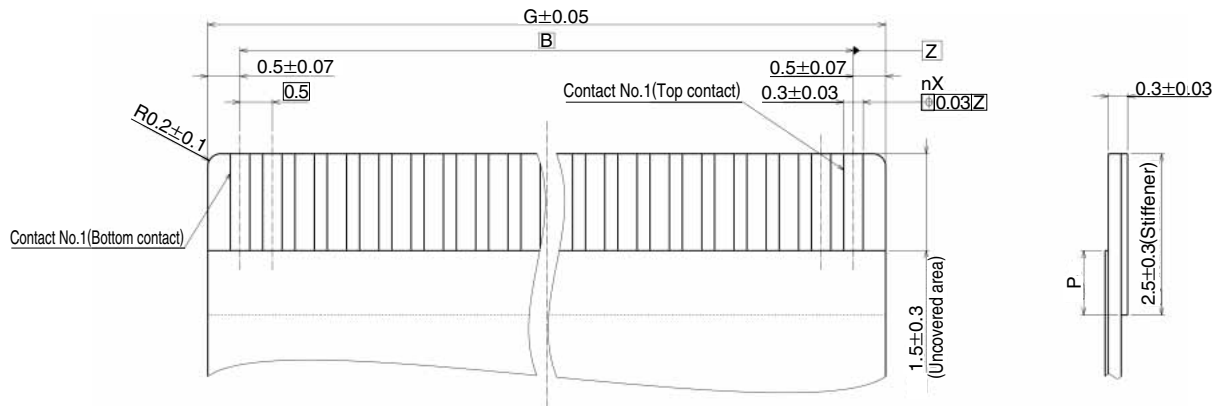

Note 1 : Dimension P shall be 0.5mm min.

Note 2 : The recommended FPC pattern above has been designed only for FH34SRJ series.

When using the FPC for FH19SC series (lower contact), uncovered area shall be 2.5±0.3mm and stiffener shall be 3.5mm min.

Unit : mm

Part No.	HRS No.	No. of Contacts	B	E	F	G
FH34SRJ-4S-0.5SH(50)	580-1238-7 50	4	1.5	3.1	3.9	2.5
FH34SRJ-5S-0.5SH(50)	580-1264-7 50	5	2	3.6	4.4	3
FH34SRJ-6S-0.5SH(50)	580-1236-1 50	6	2.5	4.1	4.9	3.5
FH34SRJ-7S-0.5SH(50)	580-1200-0 50	7	3	4.6	5.4	4
FH34SRJ-8S-0.5SH(50)	580-1231-8 50	8	3.5	5.1	5.9	4.5
FH34SRJ-9S-0.5SH(50)	580-1262-1 50	9	4	5.6	6.4	5
FH34SRJ-10S-0.5SH(50)	580-1251-5 50	10	4.5	6.1	6.9	5.5
FH34SRJ-11S-0.5SH(50)	580-1258-4 50	11	5	6.6	7.4	6
FH34SRJ-12S-0.5SH(50)	580-1253-0 50	12	5.5	7.1	7.9	6.5
FH34SRJ-14S-0.5SH(50)	580-1252-8 50	14	6.5	8.1	8.9	7.5
FH34SRJ-16S-0.5SH(50)	580-1259-7 50	16	7.5	9.1	9.9	8.5
FH34SRJ-18S-0.5SH(50)	580-1248-0 50	18	8.5	10.1	10.9	9.5
FH34SRJ-20S-0.5SH(50)	580-1256-9 50	20	9.5	11.1	11.9	10.5
FH34SRJ-22S-0.5SH(50)	580-1254-3 50	22	10.5	12.1	12.9	11.5
FH34SRJ-24S-0.5SH(50)	580-1255-6 50	24	11.5	13.1	13.9	12.5
FH34SRJ-26S-0.5SH(50)	580-1247-8 50	26	12.5	14.1	14.9	13.5
FH34SRJ-30S-0.5SH(50)	580-1232-0 50	30	14.5	16.1	16.9	15.5
FH34SRJ-34S-0.5SH(50)	580-1261-9 50	34	16.5	18.1	18.9	17.5
FH34SRJ-40S-0.5SH(50)	580-1260-6 50	40	19.5	21.1	21.9	20.5
FH34SRJ-45S-0.5SH(50)	580-1265-0 50	45	22	23.6	24.4	23
FH34SRJ-50S-0.5SH(50)	580-1266-2 50	50	24.5	26.1	26.9	25.5

## ◆ Recommended FPC construction

● Contact FPC manufacturer for specific details.

### 1. Using Single-sided FPC

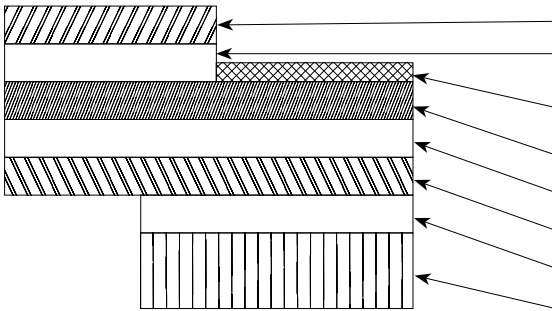

### FPC : Flexible Printed Circuit

Material Name	Material	Material Thickness (μm)
Covering film layer	Polyimide 1 mil thick	(25)
Cover adhesive		(25)
Surface treatment	0.2μm thick gold plated over 1 to 5μm thick nickel underplating	3
Copper foil	Cu 1oz	35
Base adhesive	Thermosetting adhesive	25
Base film	Polyimide 1 mil thick	25
Reinforcement material adhesive	Thermosetting adhesive	35
Stiffener	Polyimide 7 mil thick	175
Total		298

### 2. Using Double-sided FPC

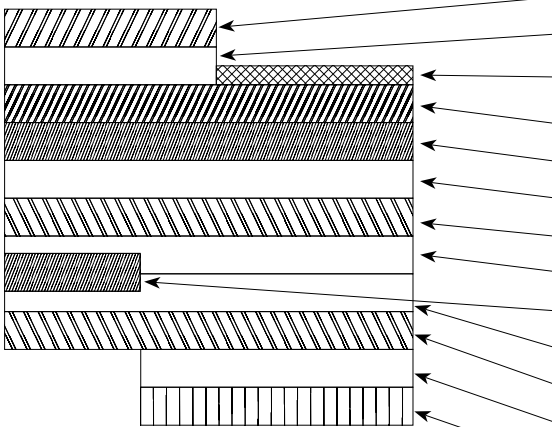

### FPC : Flexible Printed Circuit

Material Name	Material	Material Thickness (μm)
Covering layer film	Polyimide 1 mil thick	(25)
Cover adhesive		(25)
Surface treatment	0.2μm thick gold plated over 1 to 5μm thick nickel underplating	3
Through-hole copper	Cu	15
Copper foil	Cu 1/2oz	18
Base adhesive	Thermosetting adhesive	18
Base film	Polyimide 1 mil thick	25
Base adhesive		18
Copper foil	Cu 1/2oz	(18)
Cover adhesive	Thermosetting adhesive	25
Covering film layer	Polyimide 1 mil thick	25
Reinforcement material adhesive	Thermosetting adhesive	50
Stiffener	Polyimide 4 mil thick	100
Total		297

\* To prevent release of the FPC due to its bending, use of the double sided FPC with copper foil on the back side is not recommended.

### 3. Using FFC

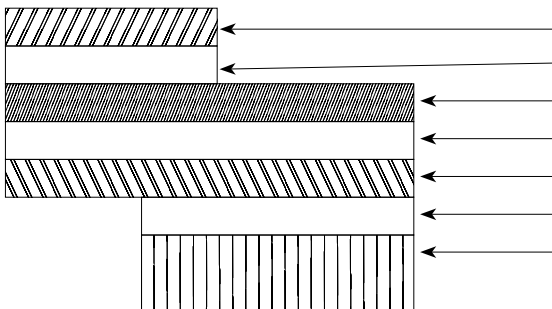

### FFC : Flexible Flat Cable

Material Name	Material	Material Thickness (μm)
Polyester film		(12)
Adhesive	Thermoplastic polyester	(30)
Gold plated annealed copper foil		35
Adhesive	Polyester	30
Polyester		12
Adhesive	Polyester	30
Stiffener	Polyester	188
Total		295

\* tolerance of ±20μm.

1. This specification is a recommendation for the construction of the FH34SRJ Series FPC and FFC (t=0.3 ± 0.03).
2. For details about the construction, please contact the FPC/FFC manufacturers.

### ◆ Packaging Specification

#### ● Embossed Carrier Tape Dimensions (Tape width 24mm max.)

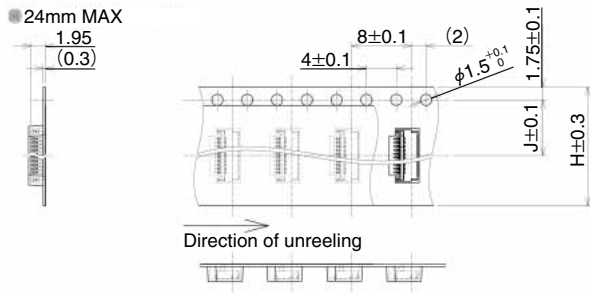

#### ● Embossed Carrier Tape Dimensions (Tape width 32mm min.)

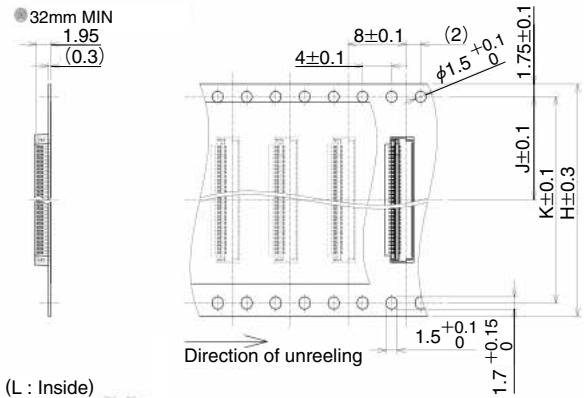

#### ● Reel Dimensions

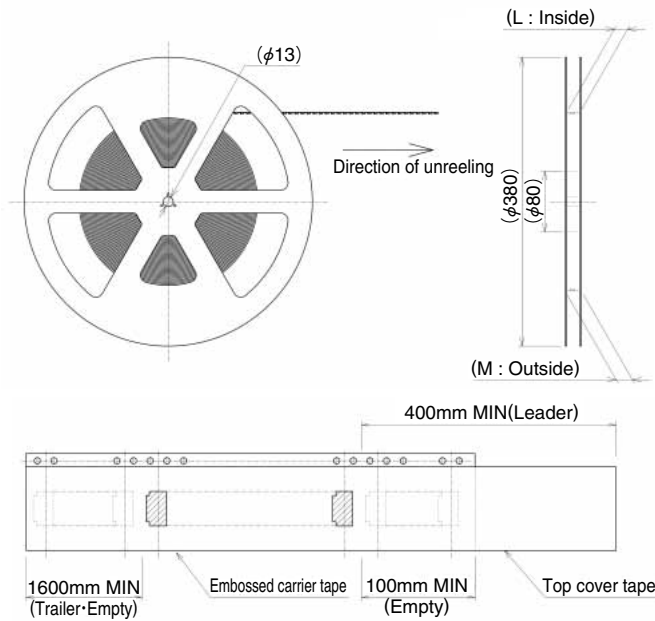

Unit : mm

Part No.	HRS No.	No. of Contacts	H	J	K	L	M	
FH34SRJ-4S-0.5SH(50)	580-1238-7 50	4	16	7.5	-	17.4	21.4	
FH34SRJ-5S-0.5SH(50)	580-1264-7 50	5			-			
FH34SRJ-6S-0.5SH(50)	580-1236-1 50	6			-			
FH34SRJ-7S-0.5SH(50)	580-1200-0 50	7			-			
FH34SRJ-8S-0.5SH(50)	580-1231-8 50	8			-			
FH34SRJ-9S-0.5SH(50)	580-1262-1 50	9			-			
FH34SRJ-10S-0.5SH(50)	580-1251-5 50	10			-			
FH34SRJ-11S-0.5SH(50)	580-1258-4 50	11	24	11.5	-	25.4	29.4	
FH34SRJ-12S-0.5SH(50)	580-1253-0 50	12			-			
FH34SRJ-14S-0.5SH(50)	580-1252-8 50	14			-			
FH34SRJ-16S-0.5SH(50)	580-1259-7 50	16			-			
FH34SRJ-18S-0.5SH(50)	580-1248-0 50	18			-			
FH34SRJ-20S-0.5SH(50)	580-1256-9 50	20			-			
FH34SRJ-22S-0.5SH(50)	580-1254-3 50	22			-			
FH34SRJ-24S-0.5SH(50)	580-1255-6 50	24	32	14.2	28.4	33.4	37.4	
FH34SRJ-26S-0.5SH(50)	580-1247-8 50	26						-
FH34SRJ-30S-0.5SH(50)	580-1232-0 50	30						-
FH34SRJ-34S-0.5SH(50)	580-1261-9 50	34	44	20.2	40.4	45.4	49.4	
FH34SRJ-40S-0.5SH(50)	580-1260-6 50	40						-
FH34SRJ-45S-0.5SH(50)	580-1265-0 50	45						-
FH34SRJ-50S-0.5SH(50)	580-1266-2 50	50						

## ◆Temperature Profile

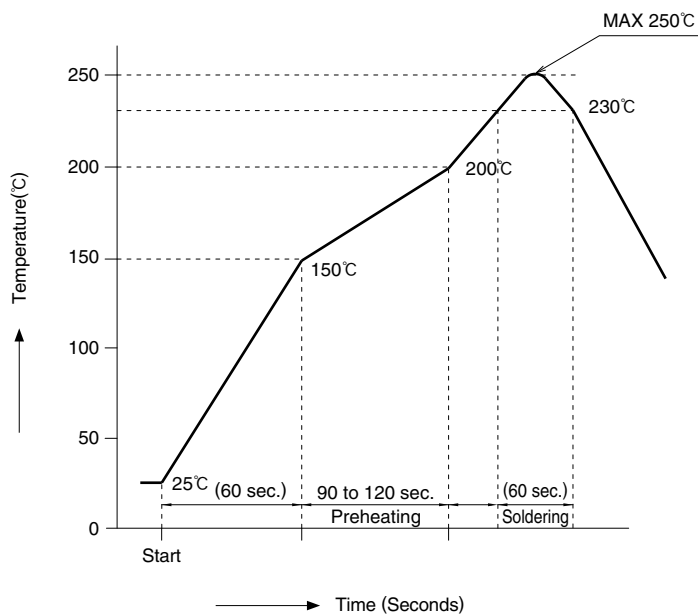

### HRS test condition

Solder method : Reflow, IR/hot air  
 Environment : Room air  
 Solder composition : Paste, 96.5%Sn/3.0%Ag/0.5%Cu  
 (Senju Metal Industry, Co., Ltd.'s Part  
 Number:  
 M705-221CM5-42-10.5)  
 Test board : Glass epoxy  
 18.3mm×32.85mm×0.8mm thick  
 Land dimensions : 0.3mm×0.8mm  
 Metal mask : 0.25×0.65×0.1mm thick

The temperature profiles shown are based on the above conditions.

In individual applications the actual temperature may vary, depending on solder paste type, volume / thickness and board size / thickness. Consult your solder paste and equipment manufacturer for specific recommendations.

## ◆ Operation and Precautions

Exercise care when handling connectors. Follow recommendations given below.

### Operation

**Caution : Handle connectors carefully, as they are very small and thin.**

**Please refer to this section for verification of the following points:**

#### 1. As delivered

- ① Delivered with the actuator open. There is no need to operate the actuator prior to inserting the FPC/FFC.

[Precautions]

- Do not close the actuator without the FPC/FFC inserted.



#### 2. FPC/FFC insertion

- ① Be sure that the FPC is parallel to the surface of the PCB, then completely insert into the connector.

[Caution]

- Do not attempt to insert the FPC if actuator is closed.
- If the actuator is closed and if the FPC is twisted during insertion, it can cause contact deformation and / or contact failure.

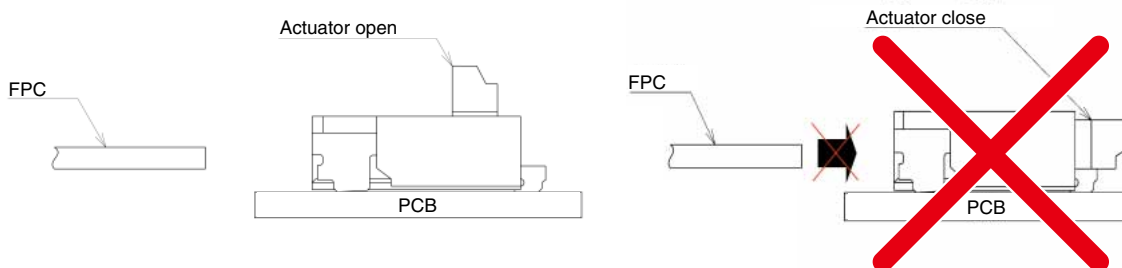

#### 3. FPC/FFC insertion (The top contact specification)

- ① Insert the FPC/FFC with the conductive surfaces facing up. Align the FPC/FFC straight with the connector and insert it firmly all the way.

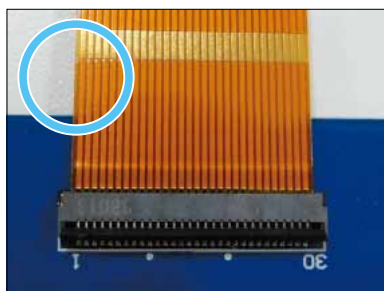
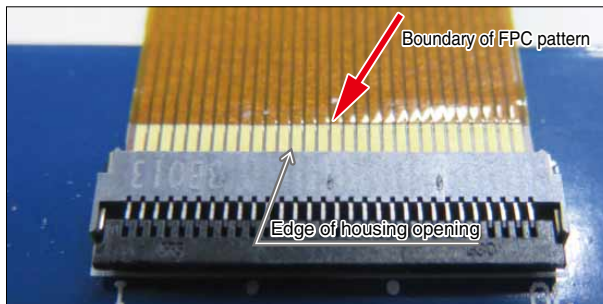

Proper insertion



Skewed insertion

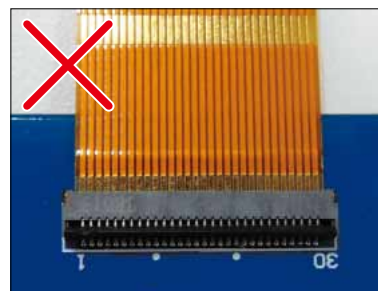

Shallow insertion

## Operation and Precautions

### Operation

#### 4. Locking

- After FPC/FFC insertion, rotate the actuator down to a full stop, pushing it at the center.

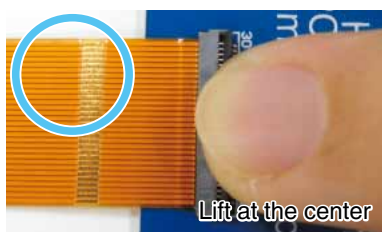
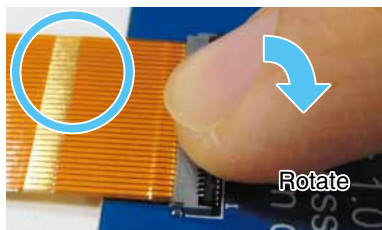

#### 5. FPC/FFC removal (Lock release)

- Carefully rotate the actuator up to 90°, lifting it at the center.

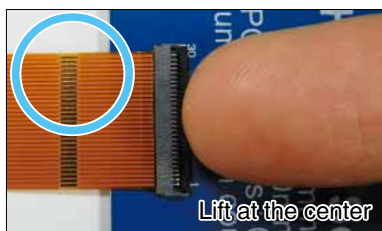
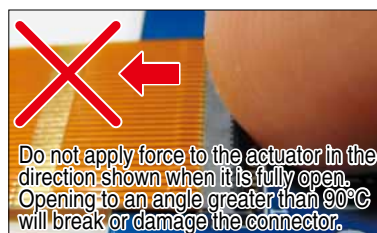
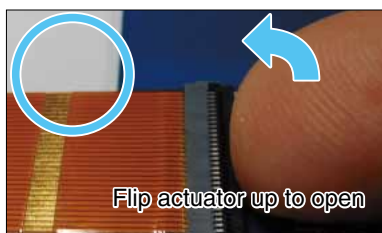

\* This connector uses a back flip type structure. The insert direction of the FPC and the actuator are different from front flip type connectors.  
Do not try to open the actuator from the FPC side.

## Operation and Precautions

### Operation

#### 6. FPC routing

- ① FPC should be routed in a manner that no strain or load is exerted onto the FPC. Placing any strain on the FPC may result in unintentional disconnect or damage to the FPC, which can lead to issues such as contact failure.

[Caution]

- Do not allow the FPC or stiffener to touch the casings, housings or any other items.
- When routing the FPC, make sure that no strain or load is applied to the connector in a pulling, pushing or side-to-side motion. Additionally, make sure that no excessive upward or downward force is applied to the connector.
- When routing the FPC, make sure that there is a stress free path for the FPC and the stiffener is parallel to the PCB. Observe correct bend radiuses.
- Do not place or mount any parts that will interfere with the FPC routing.

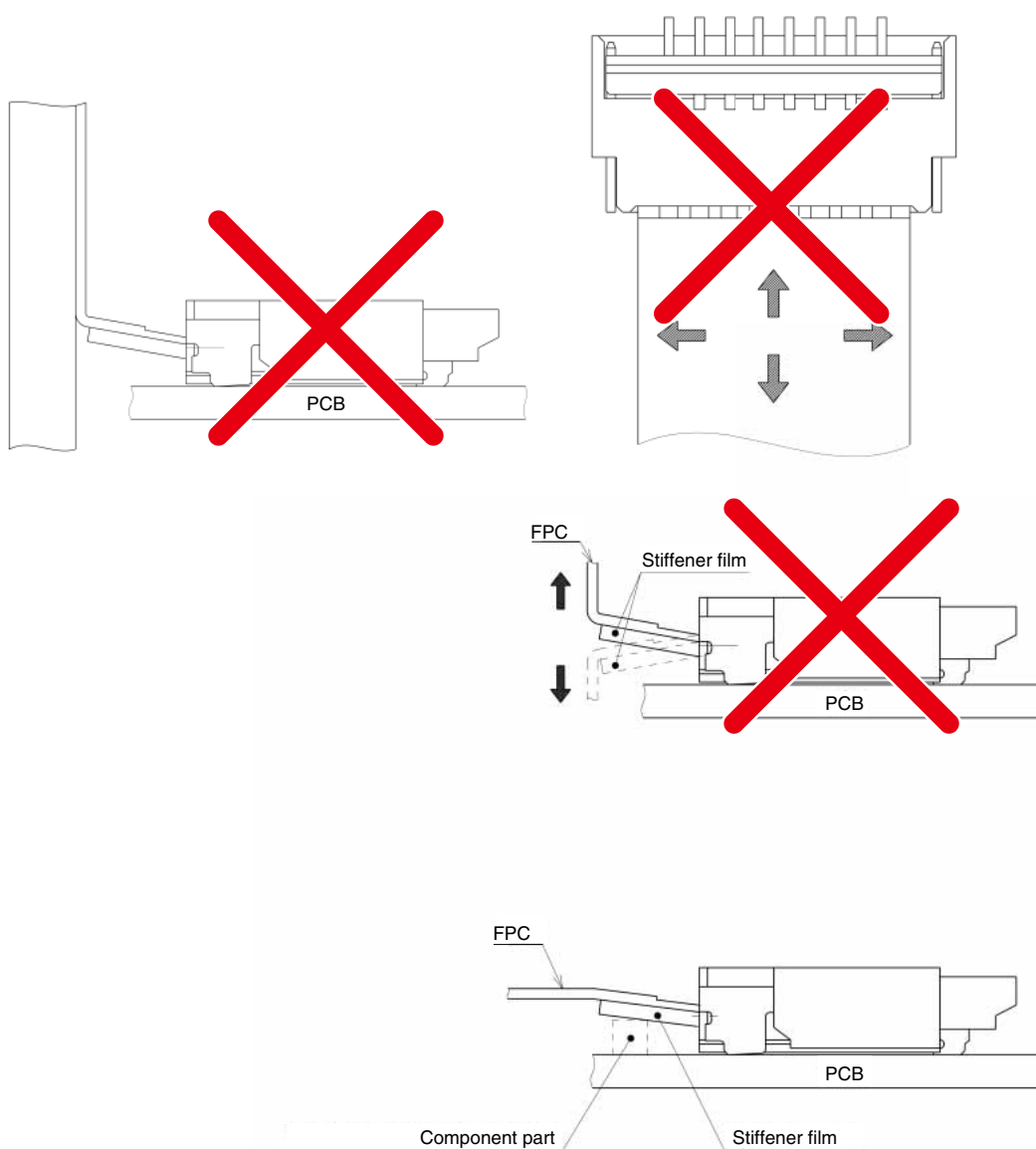

## ◆ Operation and Precautions

### Precautions when mounting connectors on the PCB

- ◆ Handling before mounting on PCB  
Insertion of the FPC/FPC or operation of the actuator prior to mounting on the PCB is not recommended.
- ◆ PC board warpage  
Minimize the warpage as much as possible. The connector are straight within 0.1 mm max. Make sure that the mounting area flatness can accept the connector terminals without causing any failure of the solder joints.
- ◆ Forces on the board
- ◆ When braking the large PC board into individual boards exercise care not to damage the installed connectors.
- ◆ When attaching the boards or other components with the screws make sure that any stresses will not cause board deflections affecting the mounting areas of the connector.

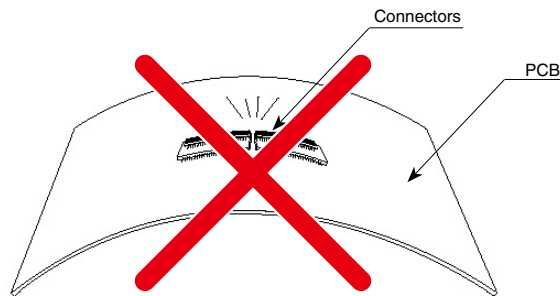

- ◆ When hand soldering:
  - Do not perform hand soldering with the FPC inserted in the connector.
  - \* Do not apply excessive heat or touch the soldering iron anywhere other than the connector leads.
  - \* Do not use excessive amount of solder or flux compounds.
 Operation of the actuator or contacts may be affected by excessive amounts of solder or flux compounds.

**USA:**

**HIROSE ELECTRIC (U.S.A.), INC. HEADQUARTERS CHICAGO OFFICE**  
 2300 Warrenville Road, Suite 150,  
 Downers Grove, IL 60515  
 Phone : +1-630-282-6700  
<http://www.hirose.com/us/>

**USA:**

**HIROSE ELECTRIC (U.S.A.), INC. SAN JOSE OFFICE**  
 2841 Junction Ave, Suite 200  
 San Jose, CA. 95134  
 Phone : +1-408-253-9640  
 Fax : +1-408-253-9641  
<http://www.hirose.com/us/>

**USA:**

**HIROSE ELECTRIC (U.S.A.), INC. DETROIT OFFICE (AUTOMOTIVE)**  
 17197 N. Laurel Park Drive, Suite 253,  
 Livonia, MI 48152  
 Phone : +1-734-542-9963  
 Fax : +1-734-542-9964  
<http://www.hirose.com/us/>

**USA:**

**HIROSE ELECTRIC (U.S.A.), INC. BOSTON OFFICE**  
 300 Brickstone Square Suite 201,  
 Andover, MA 01810  
 Phone : +1-978-662-5255

**THE NETHERLANDS:**

**HIROSE ELECTRIC EUROPE B.V.**  
 Hogehillweg #8 1101 CC Amsterdam Z-0  
 Phone : +31-20-6557460  
 Fax : +31-20-6557469  
<http://www.hirose.com/eu/>

**GERMANY:**

**HIROSE ELECTRIC EUROPE B.V. GERMAN BRANCH**  
 Schoenbergstr. 20, 73760 ostfildern  
 Phone : +49-711-456002-1  
 Fax : +49-711-456002-299  
<http://www.hirose.com/eu/>

**GERMANY:**

**HIROSE ELECTRIC EUROPE B.V. NUREMBERG OFFICE**  
 Neumeyerstrasse 22-26, 90411 Nurnberg  
 Phone : +49-911 32 68 89 63  
 Fax : +49-911 32 68 89 69  
<http://www.hirose.com/eu/>

**GERMANY:**

**HIROSE ELECTRIC EUROPE B.V. HANOVER OFFICE**  
 Bayernstr. 3, Haus C 30855 Langenhagen, Germany  
 Phone : +49-511 97 82 61 30  
 Fax : +49-511 97 82 61 35  
<http://www.hirose.com/eu/>

**FRANCE:**

**HIROSE ELECTRIC EUROPE B.V. PARIS OFFICE**  
 Regus La Garenne Colombes, Place de La Belgique,  
 71 Boulevard National La Garenne Colombes, 92250, France  
 Phone : +33 (0) 1 7082 3170  
 Fax : +33 (1) 7082 3101  
<http://www.hirose.com/eu/>

**UNITED KINGDOM:**

**HIROSE ELECTRIC EUROPE BV (UK BRANCH)**  
 4 Newton Court, Kelvin Drive, Knowlhill,  
 Milton Keynes, MK5 8NH  
 Phone : +44-1908 202050  
 Fax : +44-1908 202058  
<http://www.hirose.com/eu/>

**CHINA:**

**HIROSE ELECTRIC (SHANGHAI) CO., LTD.**  
 18, Enterprise Center Tower 2, 209# Gong He  
 Road, Jing'an District, Shanghai, CHINA 200070  
 Phone : +86-21-6391-3355  
 Fax : +86-21-6391-3335  
<http://www.hirose.com/cn/>

**CHINA:**

**HIROSE ELECTRIC (SHANGHAI) CO.,LTD. BEIJING BRANCH**  
 A1001, Ocean International Center, Building 56# East 4th  
 Ring Middle Road, ChaoYang District, Beijing, 100025  
 Phone : +86-10-5165-9332  
 Fax : +86-10-5908-1381  
<http://www.hirose.com/cn/>

**CHINA:**

**HIROSE ELECTRIC TECHNOLOGIES (SHENZHEN) CO., LTD.**  
 Room 09-13, 19/F, Office Tower Shun Hing Square, Di Wang Commercial Centre,  
 5002 Shen Nan Dong Road, Shenzhen City, Guangdong Province, 518008  
 Phone : +86-755-8207-0851  
 Fax : +86-755-8207-0873  
<http://www.hirose.com/cn/>

**HONG KONG:**

**HIROSE ELECTRIC HONGKONG TRADING CO., LTD.**  
 Room 1001, West Wing, Tsim Sha Tsui Centre, 66  
 Mody Road, Tsim Sha Tsui East, Kowloon, Hong Kong  
 Phone : +852-2803-5338  
 Fax : +852-2591-6560  
<http://www.hirose.com/hk/>

**TAIWAN:**

**HIROSE ELECTRIC TAIWAN CO., LTD.**  
 103 8F, No.87, Zhengzhou Rd., Taipei  
 Phone : +886-2-2555-7377  
 Fax : +886-2-2555-7350  
<http://www.hirose.com/tw/>

**KOREA:**

**HIROSE KOREA CO.,LTD.**  
 250, Huimanggongwon-ro, Siheung-si,  
 Gyeonggi-do, Korea, 15083  
 Phone : +82-31-496-7000 or 7124  
 Fax : +82-31-496-7100  
<http://www.hirose.co.kr/>

**SINGAPORE:**

**HIROSE ELECTRIC SINGAPORE PTE. LTD.**  
 10 Anson Road #26-16, International Plaza  
 079903, Singapore  
 Phone : +65-6324-6113  
 Fax : +65-6324-6123  
<http://www.hirose.com/sg/>

**INDIA:**

**HIROSE ELECTRIC SINGAPORE PTE. LTD. DELHI LIAISON OFFICE**  
 Office NO.552, Regus-Green Boulevard, Level5, Tower C,  
 Sec62, Plot B-9A, Block B, Noida, 201301, Uttar Pradesh, India  
 Phone : +91-12-660-8018  
 Fax : +91-120-4804949  
<http://www.hirose.com/sg/>

**INDIA:**

**HIROSE ELECTRIC SINGAPORE PTE. LTD. BANGALORE LIAISON OFFICE**  
 Unit No-403, 4th Floor, No-84, Barton Centre, Mahatma  
 Gandhi (MG) Road, Bangalore 560 001, Karnataka, India  
 Phone : +91-80-4120 1907  
 Fax : +91-80-4120 9908  
<http://www.hirose.com/sg/>

**MALAYSIA:**

**PENANG REPRESENTATIVE OFFICE**  
 1-21-01, Suntech @ Penang Cybercity (1164), Lintang  
 Mayang Pasir 3,11950, Bayan Baru, Penang, Malaysia.  
 Phone : +604-619-2564  
 Fax : +604-619-2574  
<http://www.hirose.com/sg/>

**THAILAND:**

**BANGKOK OFFICE (REPRESENTATIVE OFFICE)**  
 Unit 4703, 47th FL., 1 Empire Tower, South Sathorn  
 Road, Yannawa, Sathorn, Bangkok 10120 Thailand  
 Phone : +66-2-686-1255  
 Fax : +66-2-686-3433  
<http://www.hirose.com/sg/>



**HIROSE ELECTRIC CO.,LTD.**

2-6-3,Nakagawa Chuoh,Tsuzuki-Ku,Yokohama-Shi 224-8540,JAPAN  
 TEL: +81-45-620-3526 Fax: +81-45-591-3726  
<http://www.hirose.com>  
<http://www.hirose-connectors.com>

## Looking for pricing, stock, or lifecycle information?

Click below to explore more details on WIN SOURCE:

- [View FH34SRJ-24S-0.5SH\(99\) on WIN SOURCE](#)
- [Hirose Electric Co Ltd Information](#)

## Optimize Your Supply Chain with WIN SOURCE Solutions

- ✓ Global Sourcing Solution
- ✓ Obsolete Management
- ✓ Cost Control Management
- ✓ Shortage Management
- ✓ Alternative Solution
- ✓ Excess Inventory Management