



**THE DATASHEET OF  
HMC603QS16E**



### Typical Applications

The HMC603QS16 / HMC603QS16E is ideal for:

- Cellular/3G Infrastructure
- ISM, MMDS
- WLAN, WiMAX, & WiBro

### Features

- 0.5 dB LSB Steps to 15.5 dB
- Single Positive Control Per Bit
- ± 0.15 dB Typical Bit Error
- High Input IP3: +50 dBm
- QSOP16 SMT Package

### Functional Diagram

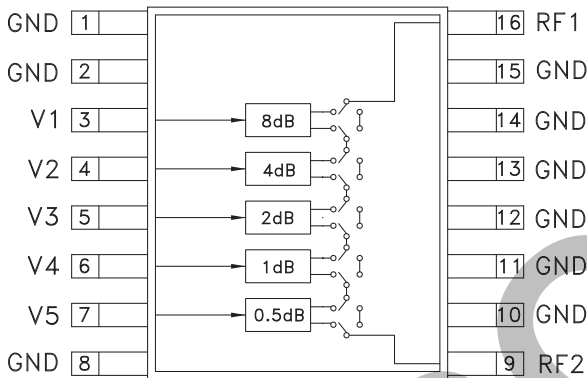

### General Description

The HMC603QS16 & HMC603QS16E are general purpose broadband 5-bit positive control GaAs IC digital attenuators in 16 lead QSOP surface mount plastic packages. Covering 0.7 to 3.8 GHz, the insertion loss is less than 1.9 dB typical. The attenuator bit values are 0.5 (LSB), 1, 2, 4 and 8 dB for a total attenuation of 15.5 dB. Attenuation accuracy is excellent at ± 0.15 dB typical with an IIP3 of +50 dBm. Five bit control voltage inputs, toggled between 0 and +3 to +5V, are used to select each attenuation state at less than 1 uA each. A single Vdd bias of +3 to +5V applied through an external 5K Ohm resistor is required.

### Electrical Specifications,

$T_A = +25^\circ C$ ,  $V_{dd} = +3V$  to  $+5V$  &  $V_{ctl} = 0/V_{dd}$  (Unless Otherwise Stated)

Parameter	Frequency (GHz)	Min.	Typical	Max.	Units	
Insertion Loss	0.7 - 1.4 GHz		1.3	1.6	dB	
	1.4 - 2.3 GHz		1.6	1.9	dB	
	2.3 - 3.0 GHz		1.9	2.2	dB	
	3.0 - 3.8 GHz		2.6	3.0	dB	
Attenuation Range			15.5		dB	
Return Loss (RF1 & RF2, All Atten. States)	0.7 - 1.4 GHz		18		dB	
	1.4 - 3.0 GHz		20		dB	
	3.0 - 3.8 GHz		15		dB	
Attenuation Accuracy: (Referenced to Insertion Loss)	0.7 - 2.2 GHz 2.2 - 3.8 GHz	All States	± (0.2 + 2% of Atten. Setting) Max.		dB	
			± (0.3 + 3% of Atten. Setting) Max.		dB	
Input Power for 0.1 dB Compression	0.7 - 3.8 GHz	V <sub>dd</sub> = 5V V <sub>dd</sub> = 3V	29		dBm	
			28		dBm	
Input Third Order Intercept Point (Two-tone Input Power = 0 dBm Each Tone)	0.7 - 3.8 GHz	REF - 2 dB States 2.5 - 15.5 dB States	53		dBm	
			48		dBm	
Switching Characteristics	0.7 - 3.8 GHz		1.6		µs	
			tRISE, tFALL (10/90% RF)	1.6		µs
			tON, tOFF (50% CTL to 10/90% RF)			



# HMC603QS16 / 603QS16E

## 0.5 dB LSB GaAs MMIC 5-BIT DIGITAL POSITIVE CONTROL ATTENUATOR, 0.7 - 3.8 GHz

**Insertion Loss**

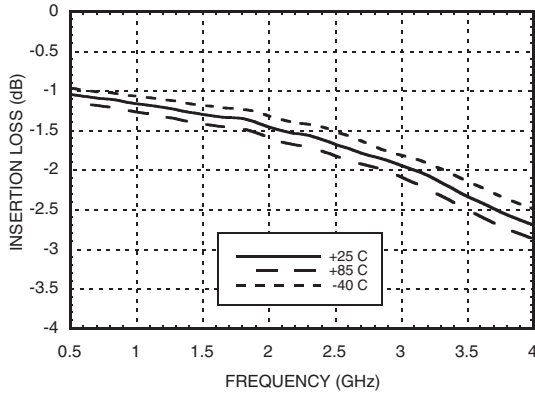

**Return Loss RF1, RF2**  
(Only Major States are Shown)

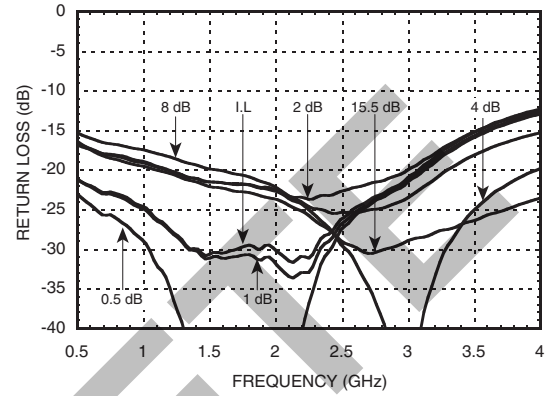

**Normalized Attenuation**  
(Only Major States are Shown)

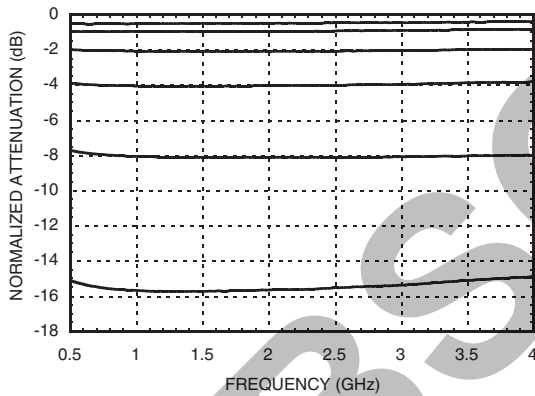

**Bit Error vs. Attenuation State**

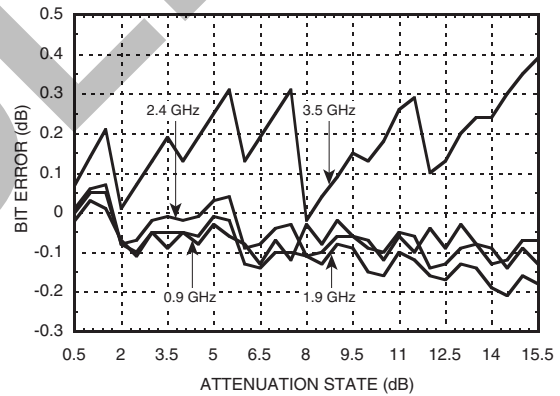

**Bit Error vs. Frequency**  
(Only Major States are Shown)

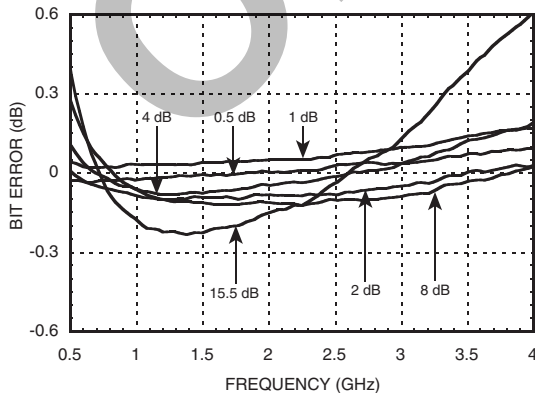

**Relative Phase vs. Frequency**  
(Only Major States are Shown)

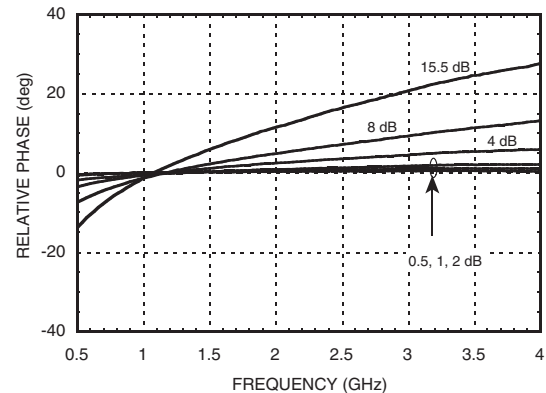



### Worst Case Step Error

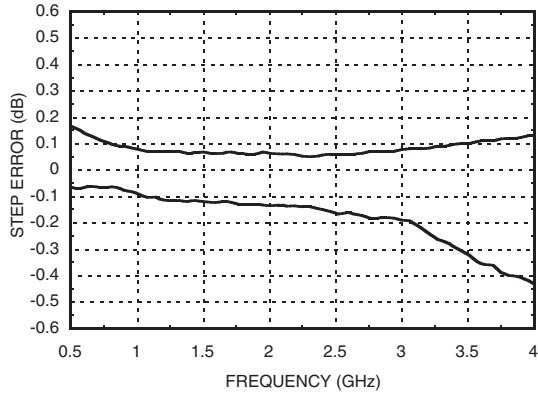

### Truth Table

Control Voltage Input					Attenuation Setting RF1 - RF2
V1 8 dB	V2 4 dB	V3 2 dB	V4 1 dB	V5 0.5 dB	
High	High	High	High	High	Reference I.L.
High	High	High	High	Low	0.5 dB
High	High	High	Low	High	1 dB
High	High	Low	High	High	2 dB
High	Low	High	High	High	4 dB
Low	High	High	High	High	8 dB
Low	Low	Low	Low	Low	15.5 dB Max. Atten.

Any combination of the above states will provide an attenuation approximately equal to the sum of the bits selected.

### Bias Voltage & Current

Vdd = +5.0 Vdc ± 10%	
Vdd (VDC)	Idd (Typ.) (µA)
+3.0	4.0
+5.0	5.0

### Control & Bias Voltages

State	Bias Condition
Low	0 to +0.2V @ 1.0 µA Max.
High	Vdd ± 0.2V @ 0.5 µA Max.

Note: Vdd = +3V to +5V ± 0.2V

### Application Circuit

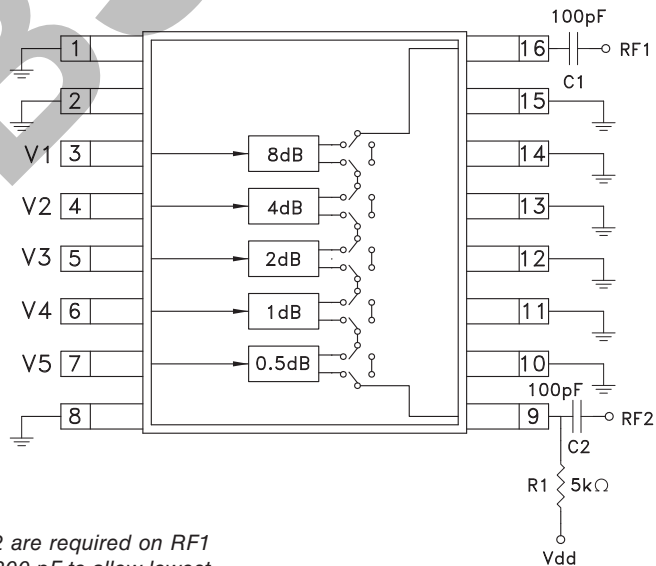

Note:  
DC Blocking Capacitors C1 & C2 are required on RF1 & RF2. Choose C1 = C2 = 100 ~ 300 pF to allow lowest customer specific frequency to pass with minimal loss.  
R1= 5K Ohm is required to supply voltage to the circuit through either Pin 9 or Pin 16.

### Absolute Maximum Ratings

RF Input Power (0.7 - 3.8 GHz)	+30 dBm
Control Voltage (V1 - V5)	Vdd + 0.5 Vdc
Bias Voltage (Vdd)	+8.0 Vdc
Channel Temperature	150 °C
Thermal Resistance	174 °C/W
Storage Temperature	-65 to +150 °C
Operating Temperature	-40 to +85 °C
ESD Sensitivity (HBM)	Class 1A



ELECTROSTATIC SENSITIVE DEVICE  
OBSERVE HANDLING PRECAUTIONS

### Outline Drawing

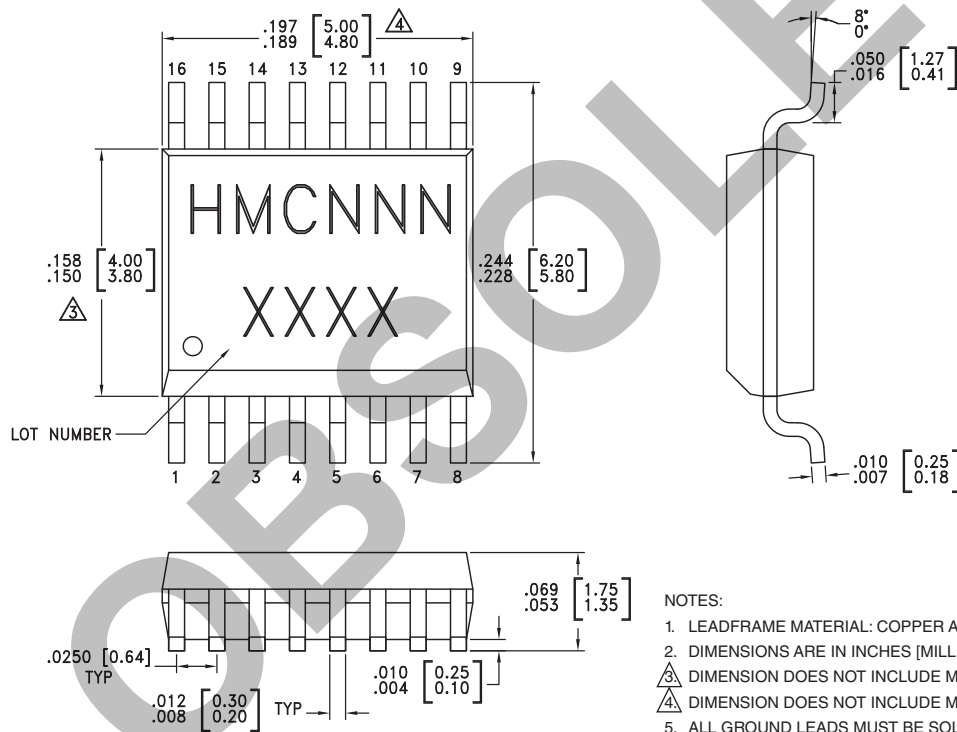

NOTES:

- LEADFRAME MATERIAL: COPPER ALLOY
- DIMENSIONS ARE IN INCHES [MILLIMETERS].
- DIMENSION DOES NOT INCLUDE MOLDFLASH OF 0.15mm PER SIDE.
- DIMENSION DOES NOT INCLUDE MOLDFLASH OF 0.25mm PER SIDE.
- ALL GROUND LEADS MUST BE SOLDERED TO PCB RF GROUND.

### Package Information

Part Number	Package Body Material	Lead Finish	MSL Rating	Package Marking <sup>[3]</sup>
HMC603QS16	Low Stress Injection Molded Plastic	Sn/Pb Solder	MSL1 <sup>[1]</sup>	HMC603 XXXX
HMC603QS16E	RoHS-compliant Low Stress Injection Molded Plastic	100% matte Sn	MSL1 <sup>[2]</sup>	HMC603 XXXX

[1] Max peak reflow temperature of 235 °C



[2] Max peak reflow temperature of 260 °C

[3] 4-Digit lot number XXXX

For price, delivery, and to place orders, please contact Hittite Microwave Corporation:  
20 Alpha Road, Chelmsford, MA 01824 Phone: 978-250-3343 Fax: 978-250-3373  
Order On-line at [www.hittite.com](http://www.hittite.com)

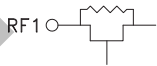

**Pin Descriptions**

Pin Number	Function	Description	Interface Schematic
1, 2, 8, 10 - 15	GND	These pins must be DC grounded.	
3 - 7	V1 - V5	See truth table and control voltage table.	
9	RF2	This pin is DC coupled and matched to 50 Ohm. A blocking capacitor is required.	
16	RF1	This pin is DC coupled and matched to 50 Ohm. A blocking capacitor is required.	

OBSOLETE



### Evaluation Circuit Board

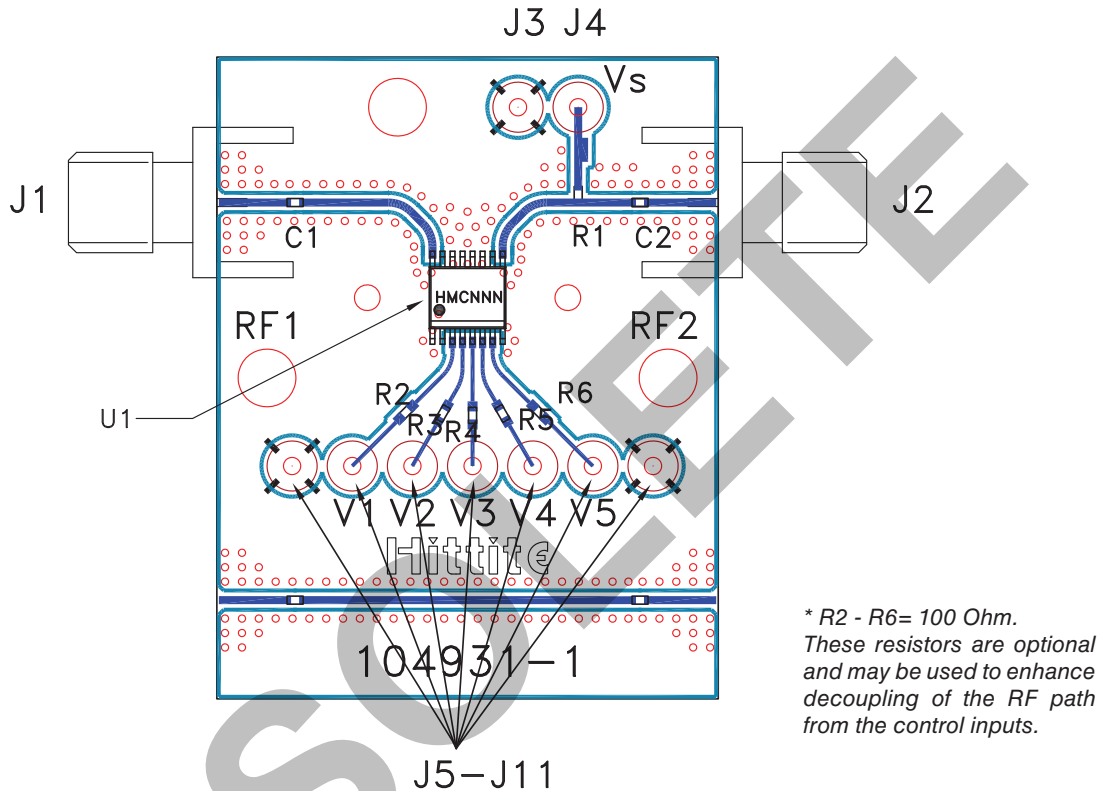

### List of Materials for Evaluation PCB 104976 [1]

Item	Description
J1 - J2	PCB Mount SMA Connector
J3 - J11	DC Pin
R1	5k Ohm Resistor, 0402 Pkg.
R2 - R6	100 Ohm Resistor, 0402 Pkg.
C1 - C2	0402 Chip Capacitor, Select Value for Lowest Frequency
U1	HMC603QS16 / HMC603QS16E Digital Attenuators
PCB [2]	104931 Evaluation PCB



[1] Reference this number when ordering complete evaluation PCB

[2] Circuit Board Material: Rogers 4350





The circuit board used in the final application should use RF circuit design techniques. Signal lines should have 50 ohm impedance while the package ground leads should be connected directly to the ground plane similar to that shown. A sufficient number of via holes should be used to connect the top and bottom ground planes. The evaluation circuit board shown is available from Hittite upon request.

## Looking for pricing, stock, or lifecycle information?

Click below to explore more details on WIN SOURCE:

-  [View HMC603QS16E on WIN SOURCE](#)
-  [Analog Devices Inc. Information](#)

## Optimize Your Supply Chain with WIN SOURCE Solutions

-  Global Sourcing Solution
-  Obsolete Management
-  Cost Control Management
-  Shortage Management
-  Alternative Solution
-  Excess Inventory Management