



**THE DATASHEET OF
LMV854MTX/NOPB**



LMV851/LMV852/LMV854 8 MHz Low Power CMOS, EMI Hardened Operational Amplifiers

Check for Samples: [LMV851](#), [LMV852](#), [LMV854](#)

FEATURES

- Unless Otherwise Noted, Typical Values at $T_A = 25^\circ\text{C}$, $V_{\text{SUPPLY}} = 3.3\text{V}$
- Supply Voltage 2.7V to 5.5V
- Supply Current (Per Channel) 0.4 mA
- Input Offset Voltage 1 mV max
- Input Bias Current 0.1 pA
- GBW 8 MHz
- EMIRR at 1.8 GHz 87 dB
- Input Noise Voltage at 1 kHz 11 nV/√Hz
- Slew Rate 4.5 V/μs
- Output Voltage Swing Rail-to-Rail
- Output Current Drive 30 mA
- Operating Ambient Temperature Range -40°C to 125°C

APPLICATIONS

- Photodiode Preamp
- Piezoelectric Sensors
- Portable/Battery-Powered Electronic Equipment
- Filters/Buffers
- PDAs/Phone Accessories
- Medical Diagnosis Equipment

Typical Application

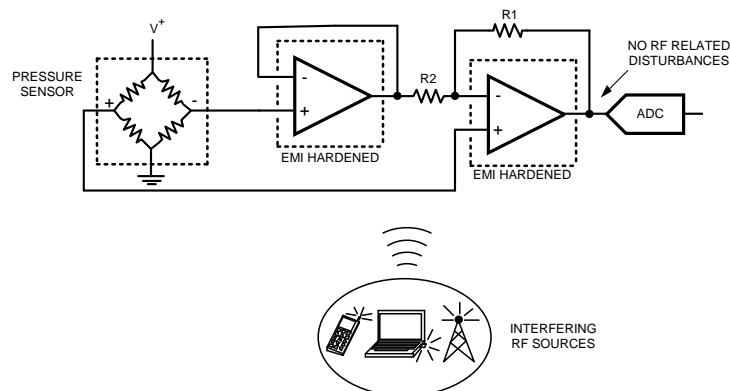

Figure 1. Sensor Amplifiers Close to RF Sources



Please be aware that an important notice concerning availability, standard warranty, and use in critical applications of Texas Instruments semiconductor products and disclaimers thereto appears at the end of this data sheet.

All trademarks are the property of their respective owners.



These devices have limited built-in ESD protection. The leads should be shorted together or the device placed in conductive foam during storage or handling to prevent electrostatic damage to the MOS gates.

Absolute Maximum Ratings ⁽¹⁾

ESD Tolerance ⁽²⁾	
Human Body Model	2 kV
Charge-Device Model	1 kV
Machine Model	200V
V _{IN} Differential	± Supply Voltage
Supply Voltage (V ⁺ – V ⁻)	6V
Voltage at Input/Output Pins	V ⁺ +0.4V V ⁻ -0.4V
Storage Temperature Range	-65°C to +150°C
Junction Temperature ⁽³⁾	+150°C
Soldering Information	
Infrared or Convection (20 sec)	+260°C

- (1) Absolute Maximum Ratings indicate limits beyond which damage to the device may occur. Operating Ratings indicate conditions for which the device is intended to be functional, but specific performance is not ensured. For ensured specifications and the test conditions, see the Electrical Characteristics Tables.
- (2) Human Body Model, applicable std. MIL-STD-883, Method 3015.7. Machine Model, applicable std. JESD22-A115-A (ESD MM std. of JEDEC) Field-Induced Charge-Device Model, applicable std. JESD22-C101-C (ESD FICDM std. of JEDEC).
- (3) The maximum power dissipation is a function of T_{J(MAX)}, θ_{JA}, and T_A. The maximum allowable power dissipation at any ambient temperature is P_D = (T_{J(MAX)} - T_A) / θ_{JA}. All numbers apply for packages soldered directly onto a PC board.

Operating Ratings ⁽¹⁾

Temperature Range ⁽²⁾	-40°C to +125°C
Supply Voltage (V ⁺ – V ⁻)	2.7V to 5.5V
Package Thermal Resistance (θ _{JA}) ⁽²⁾	
5-Pin SC70	313 °C/W
8-Pin VSSOP	217 °C/W
14-Pin TSSOP	135 °C/W

- (1) Absolute Maximum Ratings indicate limits beyond which damage to the device may occur. Operating Ratings indicate conditions for which the device is intended to be functional, but specific performance is not ensured. For ensured specifications and the test conditions, see the Electrical Characteristics Tables.
- (2) The maximum power dissipation is a function of T_{J(MAX)}, θ_{JA}, and T_A. The maximum allowable power dissipation at any ambient temperature is P_D = (T_{J(MAX)} - T_A) / θ_{JA}. All numbers apply for packages soldered directly onto a PC board.

3.3V Electrical Characteristics ⁽¹⁾

Unless otherwise specified, all limits are specified for T_A = 25°C, V⁺ = 3.3V, V⁻ = 0V, V_{CM} = V⁺/2, and R_L = 10 kΩ to V⁺/2.

Boldface limits apply at the temperature extremes.

Parameter		Test Conditions	Min ⁽²⁾	Typ ⁽³⁾	Max ⁽²⁾	Units
V _{OS}	Input Offset Voltage			±0.26 See ⁽⁴⁾	±1 ±1.2	mV
TCV _{OS}	Input Offset Voltage Drift ⁽⁵⁾			±0.4 See ⁽⁴⁾	±2	µV/°C
I _B	Input Bias Current ⁽⁵⁾			0.1	10 500	pA

- (1) Electrical table values apply only for factory testing conditions at the temperature indicated. Factory testing conditions result in very limited self-heating of the device.
- (2) Limits are 100% production tested at 25°C. Limits over the operating temperature range are specified through correlations using statistical quality control (SQC) method.
- (3) Typical values represent the most likely parametric norm as determined at the time of characterization. Actual typical values may vary over time and will also depend on the application and configuration. The typical values are not tested and are not ensured on shipped production material.
- (4) The typical value is calculated by applying absolute value transform to the distribution, then taking the statistical average of the resulting distribution
- (5) This parameter is specified by design and/or characterization and is not tested in production.

3.3V Electrical Characteristics ⁽¹⁾ (continued)

Unless otherwise specified, all limits are specified for $T_A = 25^\circ\text{C}$, $V^+ = 3.3\text{V}$, $V^- = 0\text{V}$, $V_{\text{CM}} = V^+/2$, and $R_L = 10\text{ k}\Omega$ to $V^+/2$.

Boldface limits apply at the temperature extremes.

Parameter		Test Conditions	Min ⁽²⁾	Typ ⁽³⁾	Max ⁽²⁾	Units
I_{OS}	Input Offset Current			1		pA
CMRR	Common Mode Rejection Ratio	$-0.2\text{V} < V_{\text{CM}} < V^+ - 1.2\text{V}$	76 75	92 See ⁽⁴⁾		dB
PSRR	Power Supply Rejection Ratio	$2.7\text{V} \leq V^+ \leq 5.5\text{V}$, $V_{\text{OUT}} = 1\text{V}$	75 74	93 ⁽⁴⁾		dB
EMIRR	EMI Rejection Ratio, IN+ and IN- ⁽⁶⁾	$V_{\text{RFpeak}} = 100\text{ mV}_P$ (-20 dBV_P), $f = 400\text{ MHz}$		64		dB
		$V_{\text{RFpeak}} = 100\text{ mV}_P$ (-20 dBV_P), $f = 900\text{ MHz}$		78		
		$V_{\text{RFpeak}} = 100\text{ mV}_P$ (-20 dBV_P), $f = 1800\text{ MHz}$		87		
		$V_{\text{RFpeak}} = 100\text{ mV}_P$ (-20 dBV_P), $f = 2400\text{ MHz}$		90		
CMVR	Input Common-Mode Voltage Range	CMRR $\geq 76\text{ dB}$	-0.2		2.1	V
A_{VOL}	Large Signal Voltage Gain ⁽⁷⁾	$R_L = 2\text{ k}\Omega$, $V_{\text{OUT}} = 0.15\text{V to } 1.65\text{V}$, $V_{\text{OUT}} = 3.15\text{V to } 1.65\text{V}$	100 97	114		dB
		$R_L = 10\text{ k}\Omega$, $V_{\text{OUT}} = 0.1\text{V to } 1.65\text{V}$, $V_{\text{OUT}} = 3.2\text{V to } 1.65\text{V}$	100 97	115		
V_{O}	Output Swing High, (measured from V^+)	$R_L = 2\text{ k}\Omega$ to $V^+/2$		31	35 43	mV
		$R_L = 10\text{ k}\Omega$ to $V^+/2$		7	10 12	
	Output Swing Low, (measured from V^-)	$R_L = 2\text{ k}\Omega$ to $V^+/2$		26	32 43	mV
		$R_L = 10\text{ k}\Omega$ to $V^+/2$		6	11 14	
I_{O}	Output Short Circuit Current	Sourcing, $V_{\text{OUT}} = V_{\text{CM}}$, $V_{\text{IN}} = 100\text{ mV}$	25 20	28		mA
		Sinking, $V_{\text{OUT}} = V_{\text{CM}}$, $V_{\text{IN}} = -100\text{ mV}$	28 20	31		
I_{S}	Supply Current	LMV851		0.42	0.50 0.58	mA
		LMV852		0.79	0.90 1.06	
		LMV854		1.54	1.67 1.99	
SR	Slew Rate ⁽⁸⁾	$A_V = +1$, $V_{\text{OUT}} = 1\text{ V}_{\text{PP}}$, 10% to 90%		4.5		V/ μs
GBW	Gain Bandwidth Product			8		MHz
Φ_m	Phase Margin			62		deg
e_n	Input-Referred Voltage Noise	$f = 1\text{ kHz}$		11		nV/ $\sqrt{\text{Hz}}$
		$f = 10\text{ kHz}$		10		
i_n	Input-Referred Current Noise	$f = 1\text{ kHz}$		0.005		pA/ $\sqrt{\text{Hz}}$
R_{OUT}	Closed Loop Output Impedance	$f = 6\text{ MHz}$		400		Ω
C_{IN}	Common-Mode Input Capacitance			11		pF
	Differential-Mode Input Capacitance			6		
THD+N	Total Harmonic Distortion + Noise	$f = 1\text{ kHz}$, $A_V = 1$, BW = $>500\text{ kHz}$		0.006		%

(6) The EMI Rejection Ratio is defined as $\text{EMIRR} = 20\log(V_{\text{RFpeak}}/\Delta V_{\text{OS}})$.

(7) The specified limits represent the lower of the measured values for each output range condition.

(8) Number specified is the slower of positive and negative slew rates.

5V Electrical Characteristics ⁽¹⁾

Unless otherwise specified, all limits are specified for $T_A = 25^\circ\text{C}$, $V^+ = 5\text{V}$, $V^- = 0\text{V}$, $V_{\text{CM}} = V^+/2$, and $R_L = 10\text{ k}\Omega$ to $V^+/2$.

Boldface limits apply at the temperature extremes.

Parameter		Test Conditions	Min ⁽²⁾	Typ ⁽³⁾	Max ⁽²⁾	Units
V_{OS}	Input Offset Voltage			± 0.26 See ⁽⁴⁾	± 1 ± 1.2	mV
TCV_{OS}	Input Offset Voltage Drift ⁽⁵⁾			± 0.4 See ⁽⁴⁾	± 2	$\mu\text{V}/^\circ\text{C}$
I_{B}	Input Bias Current ⁽⁵⁾			0.1	10 500	μA
I_{OS}	Input Offset Current			1		μA
CMRR	Common Mode Rejection Ratio	$-0.2\text{V} \leq V_{\text{CM}} \leq V^+ - 1.2\text{V}$	77 76	94 See ⁽⁴⁾		dB
PSRR	Power Supply Rejection Ratio	$2.7\text{V} \leq V^+ \leq 5.5\text{V}$, $V_{\text{OUT}} = 1\text{V}$	75 74	93 See ⁽⁴⁾		dB
EMIRR	EMI Rejection Ratio, IN+ and IN- ⁽⁶⁾	$V_{\text{RFpeak}} = 100\text{ mV}_\text{P}$ (-20 dBV_P), $f = 400\text{ MHz}$		64		dB
		$V_{\text{RFpeak}} = 100\text{ mV}_\text{P}$ (-20 dBV_P), $f = 900\text{ MHz}$		76		
		$V_{\text{RFpeak}} = 100\text{ mV}_\text{P}$ (-20 dBV_P), $f = 1800\text{ MHz}$		84		
		$V_{\text{RFpeak}} = 100\text{ mV}_\text{P}$ (-20 dBV_P), $f = 2400\text{ MHz}$		89		
CMVR	Input Common-Mode Voltage Range	CMRR $\geq 77\text{ dB}$	-0.2		3.8	V
A_{VOL}	Large Signal Voltage Gain ⁽⁷⁾	$R_L = 2\text{ k}\Omega$, $V_{\text{OUT}} = 0.15\text{V to } 2.5\text{V}$, $V_{\text{OUT}} = 4.85\text{V to } 2.5\text{V}$	105 102	118		dB
		$R_L = 10\text{ k}\Omega$, $V_{\text{OUT}} = 0.1\text{V to } 2.5\text{V}$, $V_{\text{OUT}} = 4.9\text{V to } 2.5\text{V}$	105 102	120		
V_{O}	Output Swing High, (measured from V^+)	$R_L = 2\text{ k}\Omega$ to $V^+/2$		34	39 47	mV
		$R_L = 10\text{ k}\Omega$ to $V^+/2$		7	11 13	
	Output Swing Low, (measured from V^-)	$R_L = 2\text{ k}\Omega$ to $V^+/2$		31	38 50	mV
		$R_L = 10\text{ k}\Omega$ to $V^+/2$		7	12 15	
I_{O}	Output Short Circuit Current	Sourcing, $V_{\text{OUT}} = V_{\text{CM}}$, $V_{\text{IN}} = 100\text{ mV}$	60 48	65		mA
		Sinking, $V_{\text{OUT}} = V_{\text{CM}}$, $V_{\text{IN}} = -100\text{ mV}$	58 44	62		
I_{S}	Supply Current	LMV851		0.43	0.52 0.60	mA
		LMV852		0.82	0.93 1.09	
		LMV854		1.59	1.73 2.05	

- (1) Electrical table values apply only for factory testing conditions at the temperature indicated. Factory testing conditions result in very limited self-heating of the device.
- (2) Limits are 100% production tested at 25°C . Limits over the operating temperature range are specified through correlations using statistical quality control (SQC) method.
- (3) Typical values represent the most likely parametric norm as determined at the time of characterization. Actual typical values may vary over time and will also depend on the application and configuration. The typical values are not tested and are not ensured on shipped production material.
- (4) The typical value is calculated by applying absolute value transform to the distribution, then taking the statistical average of the resulting distribution
- (5) This parameter is specified by design and/or characterization and is not tested in production.
- (6) The EMI Rejection Ratio is defined as $\text{EMIRR} = 20\log (V_{\text{RFpeak}}/\Delta V_{\text{OS}})$.
- (7) The specified limits represent the lower of the measured values for each output range condition.

5V Electrical Characteristics ⁽¹⁾ (continued)

Unless otherwise specified, all limits are specified for $T_A = 25^\circ\text{C}$, $V^+ = 5\text{V}$, $V^- = 0\text{V}$, $V_{\text{CM}} = V^+/2$, and $R_L = 10\text{ k}\Omega$ to $V^+/2$.

Boldface limits apply at the temperature extremes.

Parameter		Test Conditions	Min ⁽²⁾	Typ ⁽³⁾	Max ⁽²⁾	Units
SR	Slew Rate ⁽⁸⁾	$A_V = +1$, $V_{\text{OUT}} = 2 V_{\text{PP}}$, 10% to 90%		4.5		V/ μs
GBW	Gain Bandwidth Product			8		MHz
Φ_m	Phase Margin			64		deg
e_n	Input-Referred Voltage Noise	$f = 1\text{ kHz}$		11		nV/ $\sqrt{\text{Hz}}$
		$f = 10\text{ kHz}$		10		
i_n	Input-Referred Current Noise	$f = 1\text{ kHz}$		0.005		pA/ $\sqrt{\text{Hz}}$
R_{OUT}	Closed Loop Output Impedance	$f = 6\text{ MHz}$		400		Ω
C_{IN}	Common-Mode Input Capacitance			11		pF
	Differential-Mode Input Capacitance			6		
THD+N	Total Harmonic Distortion + Noise	$f = 1\text{ kHz}$, $A_V = 1$, $\text{BW} = >500\text{ kHz}$		0.003		%

(8) Number specified is the slower of positive and negative slew rates.

Connection Diagrams

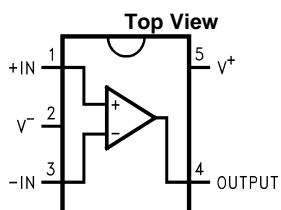

Figure 2. 5-Pin SC70 Package
See Package Number DCK0005A

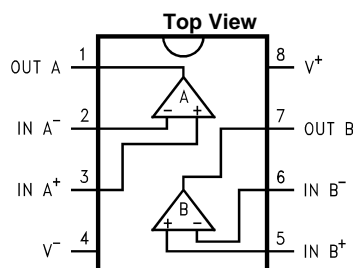

Figure 3. 8-Pin VSSOP Package
See Package Number DGK0008A

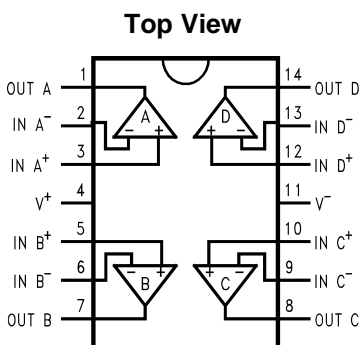

Figure 4. 14-Pin TSSOP Package
See Package Number PW0014A

Typical Performance Characteristics

At $T_A = 25^\circ\text{C}$, $R_L = 10\text{ k}\Omega$, $V_S = 3.3\text{V}$, unless otherwise specified.

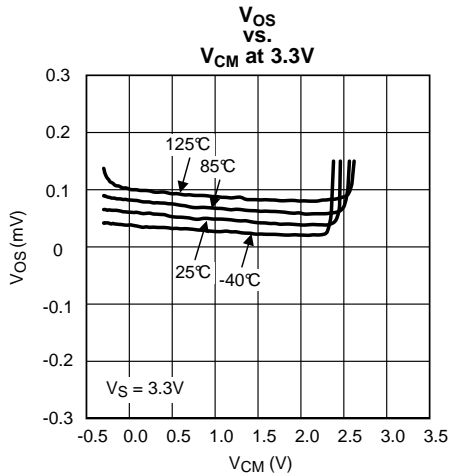

Figure 5.

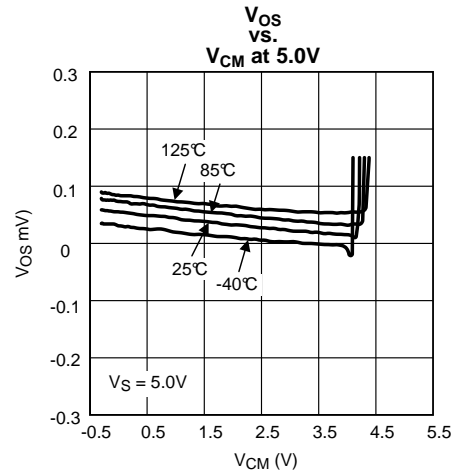

Figure 6.

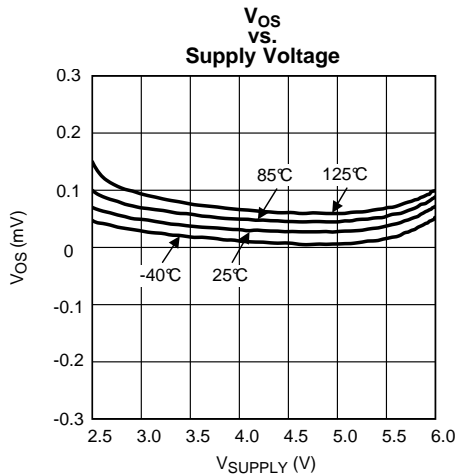

Figure 7.

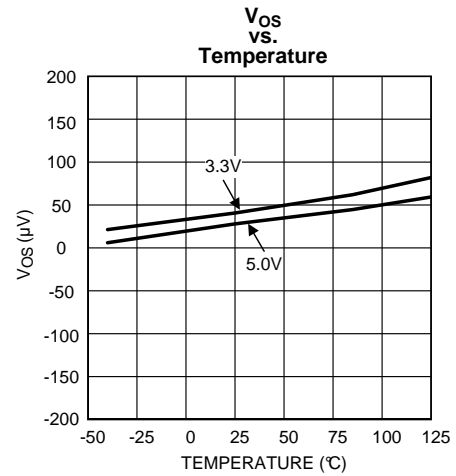

Figure 8.

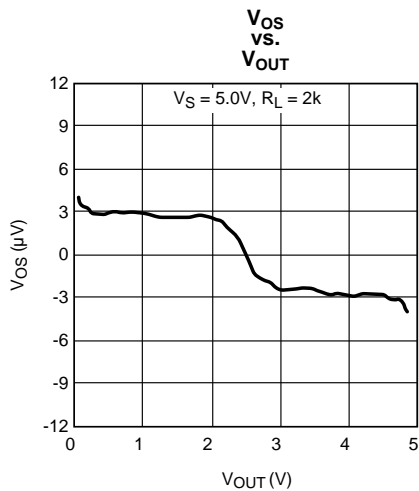

Figure 9.

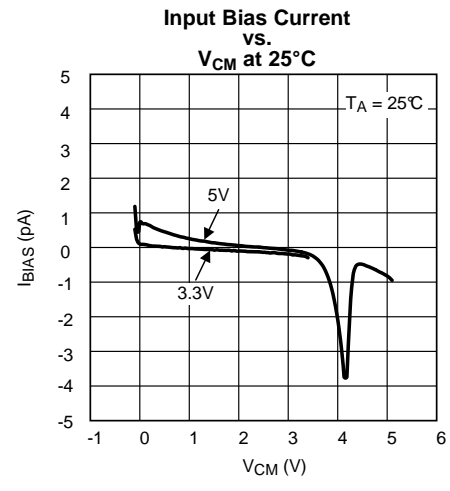

Figure 10.

Typical Performance Characteristics (continued)

At $T_A = 25^\circ\text{C}$, $R_L = 10\text{ k}\Omega$, $V_S = 3.3\text{V}$, unless otherwise specified.

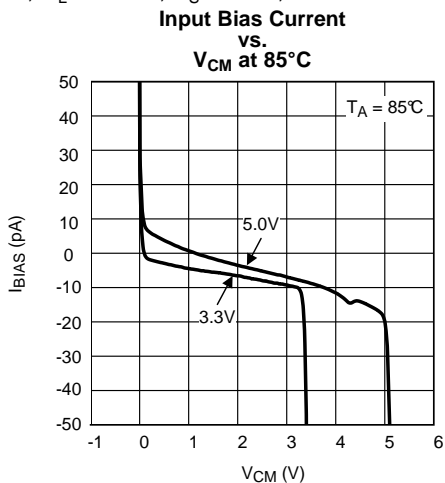

Figure 11.

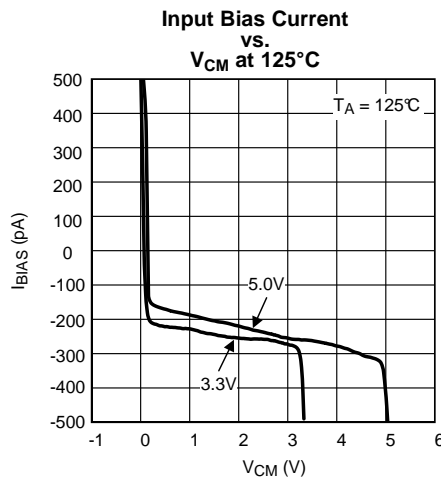

Figure 12.

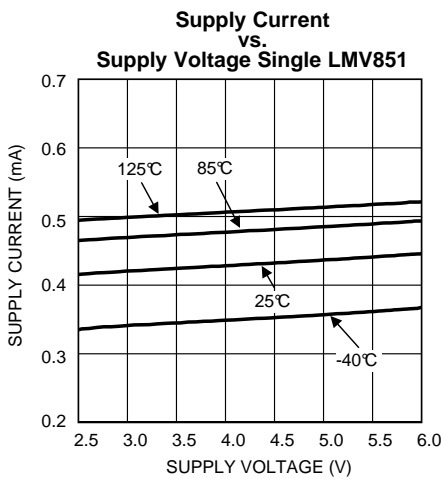

Figure 13.

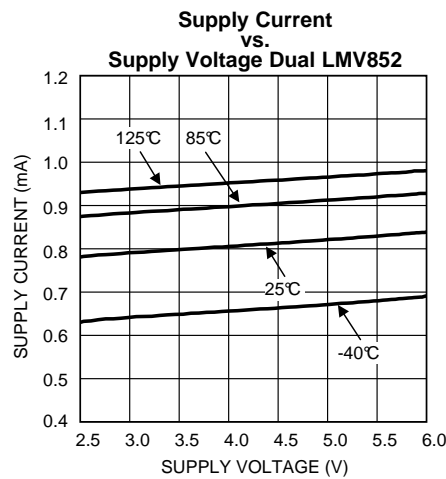

Figure 14.

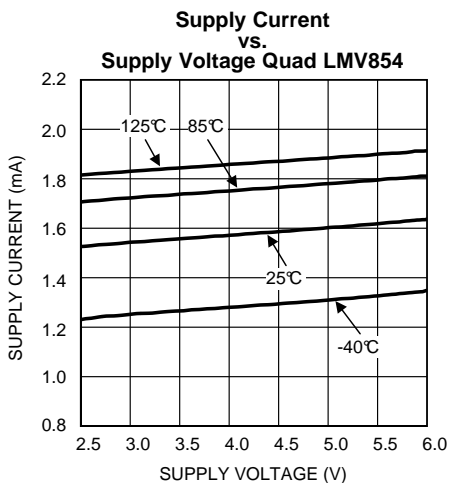

Figure 15.

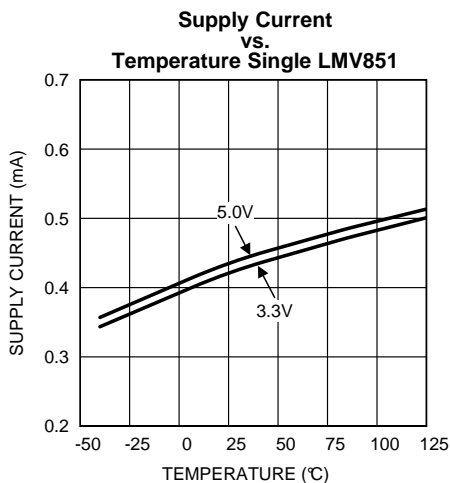

Figure 16.

Typical Performance Characteristics (continued)

At $T_A = 25^\circ\text{C}$, $R_L = 10\text{ k}\Omega$, $V_S = 3.3\text{V}$, unless otherwise specified.

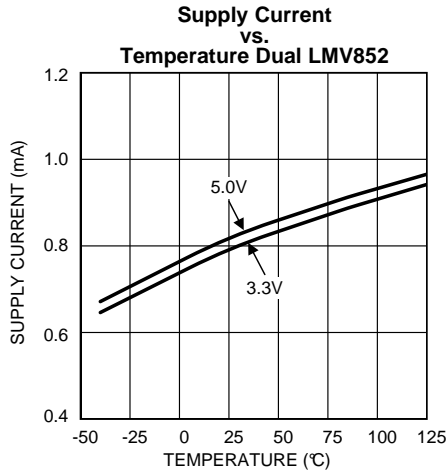

Figure 17.

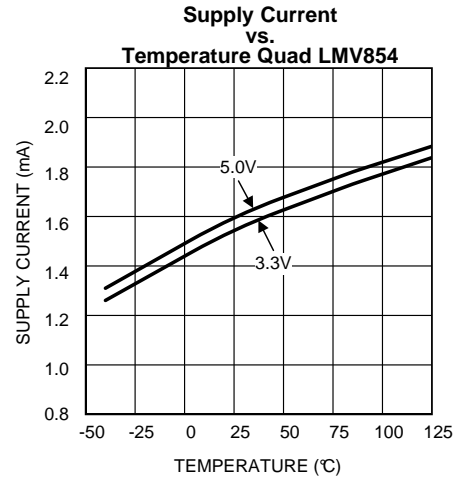

Figure 18.

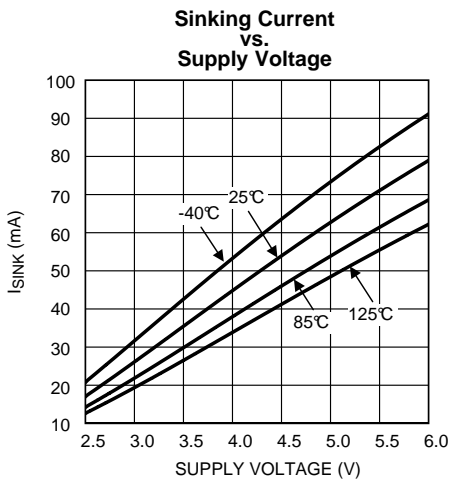

Figure 19.

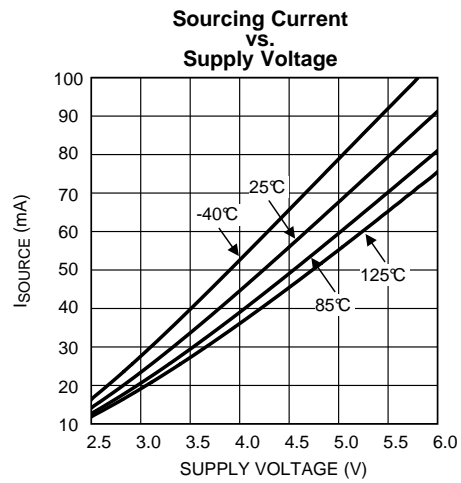

Figure 20.

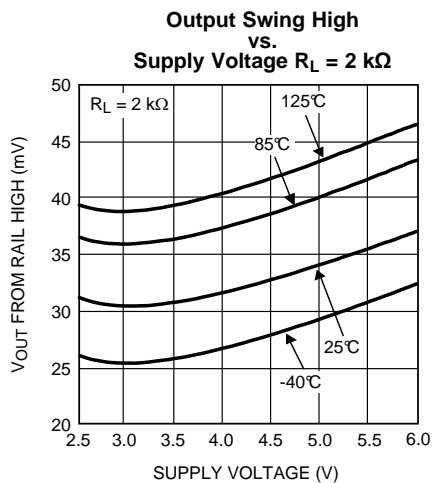

Figure 21.

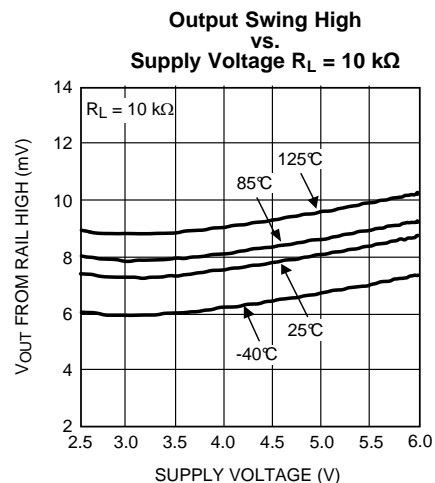

Figure 22.

Typical Performance Characteristics (continued)

At $T_A = 25^\circ\text{C}$, $R_L = 10\text{ k}\Omega$, $V_S = 3.3\text{V}$, unless otherwise specified.

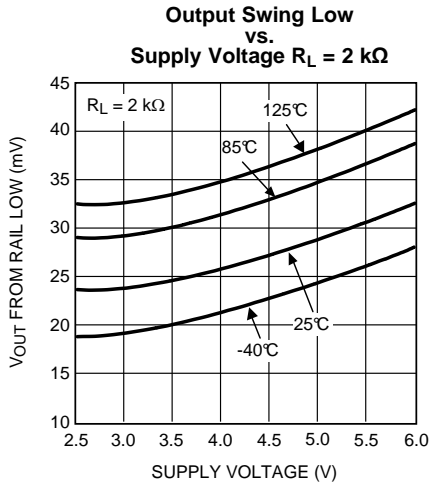

Figure 23.

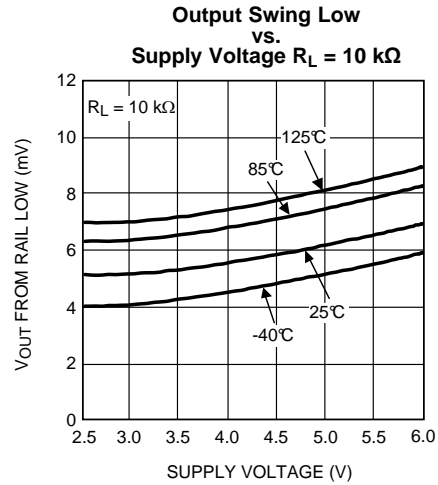

Figure 24.

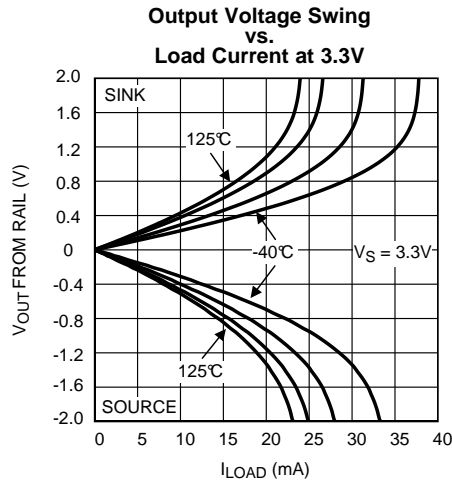

Figure 25.

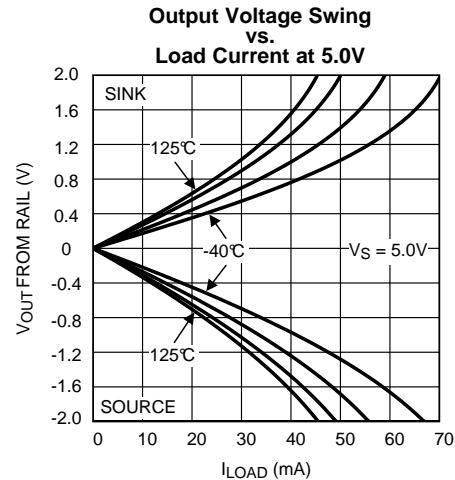

Figure 26.

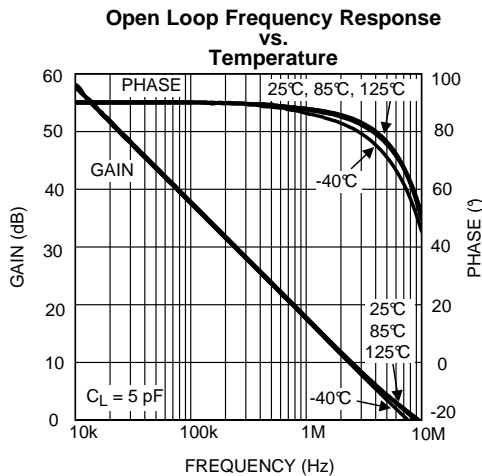

Figure 27.

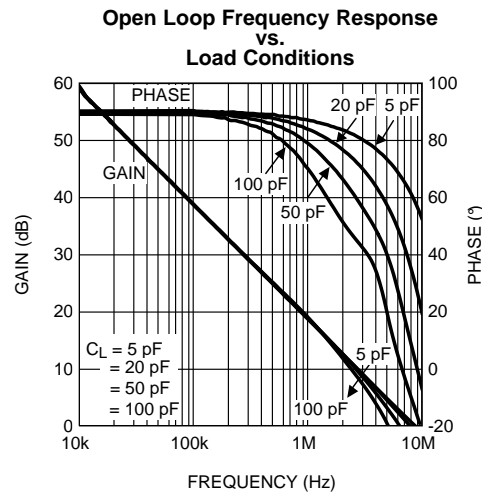

Figure 28.

Typical Performance Characteristics (continued)

At $T_A = 25^\circ\text{C}$, $R_L = 10\text{ k}\Omega$, $V_S = 3.3\text{V}$, unless otherwise specified.

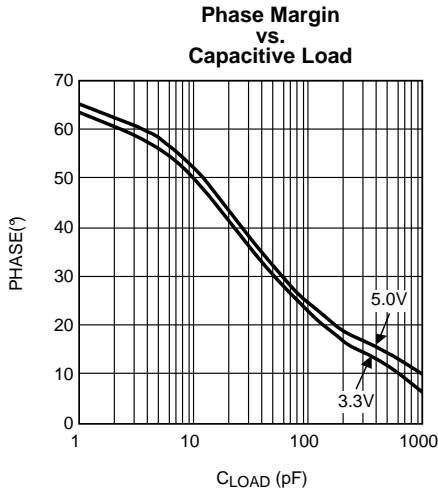

Figure 29.

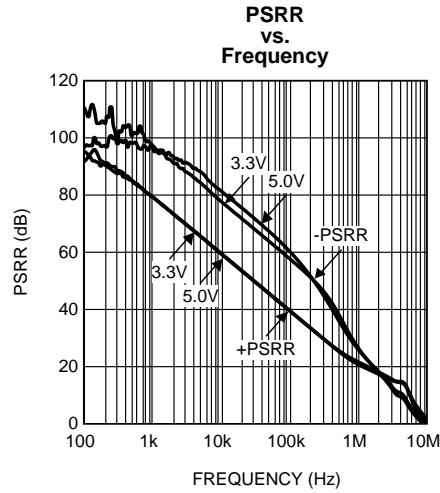

Figure 30.

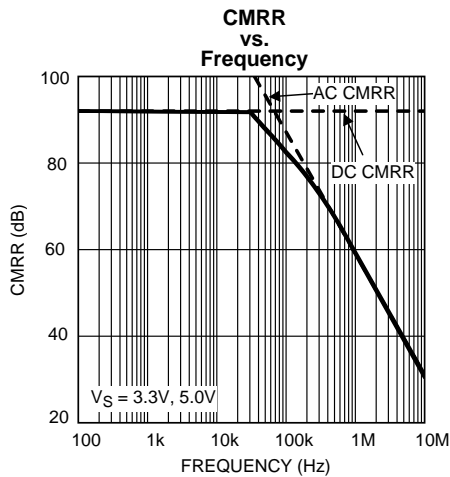

Figure 31.

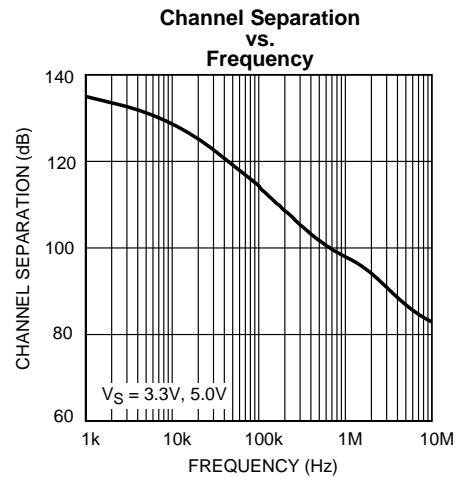

Figure 32.

Large Signal Step Response with Gain = 1

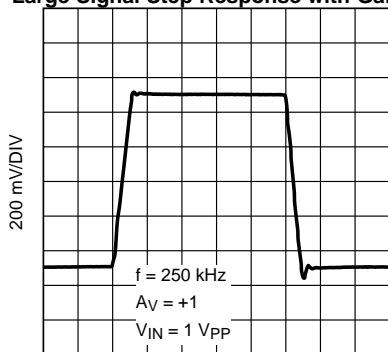

Figure 33.

Large Signal Step Response with Gain = 10

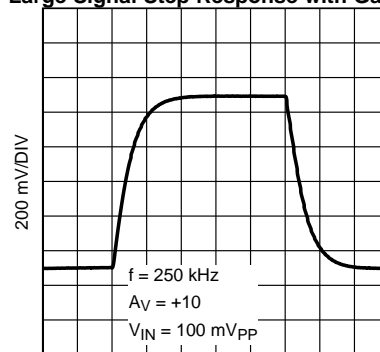

Figure 34.

Typical Performance Characteristics (continued)

At $T_A = 25^\circ\text{C}$, $R_L = 10\text{ k}\Omega$, $V_S = 3.3\text{V}$, unless otherwise specified.

Small Signal Step Response with Gain = 1

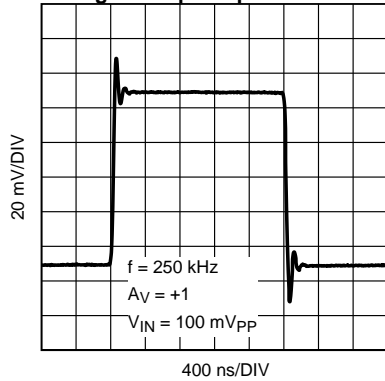

Figure 35.

Small Signal Step Response with Gain = 10

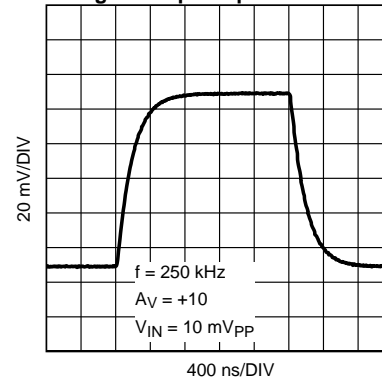

Figure 36.

Slew Rate vs. Supply Voltage

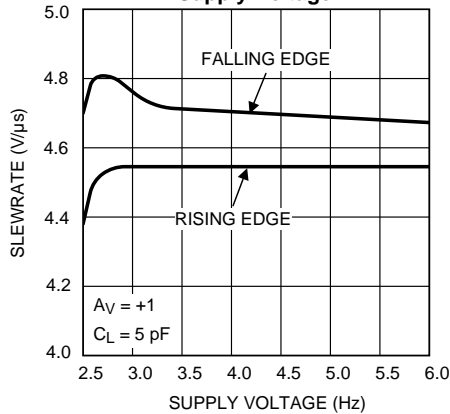

Figure 37.

Overshoot vs. Capacitive Load

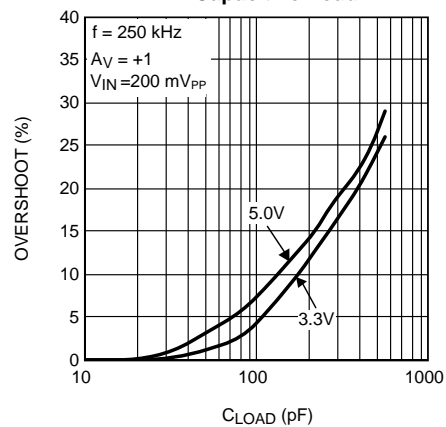

Figure 38.

Input Voltage Noise vs. Frequency

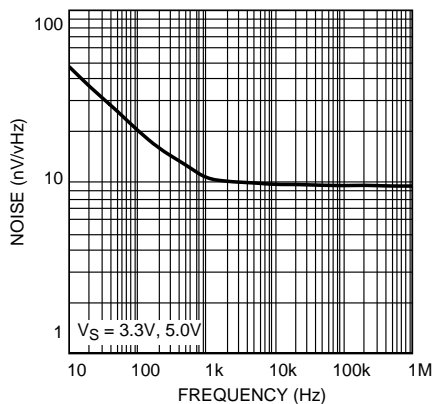

Figure 39.

THD+N vs. Frequency

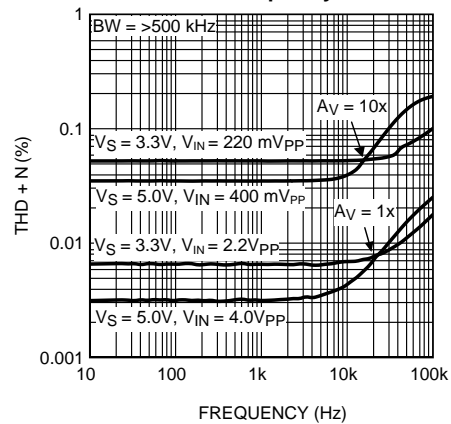

Figure 40.

Typical Performance Characteristics (continued)

At $T_A = 25^\circ\text{C}$, $R_L = 10\text{ k}\Omega$, $V_S = 3.3\text{V}$, unless otherwise specified.

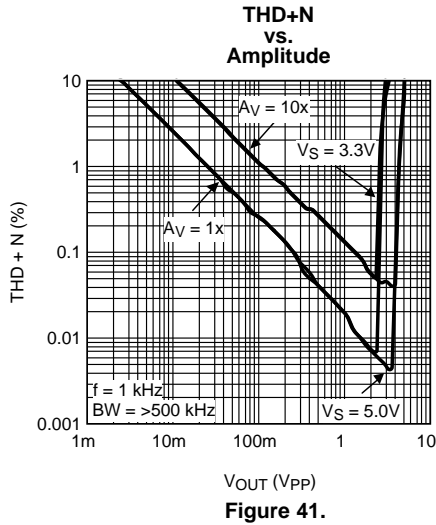

Figure 41.

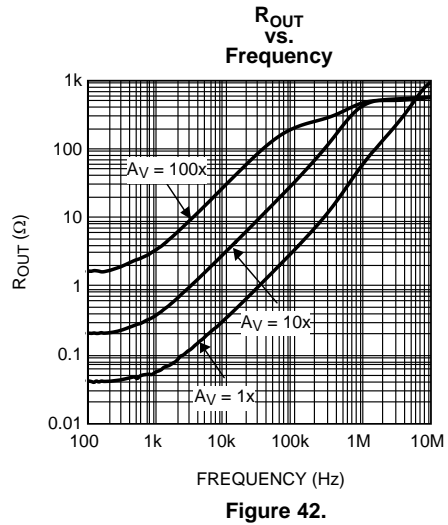

Figure 42.

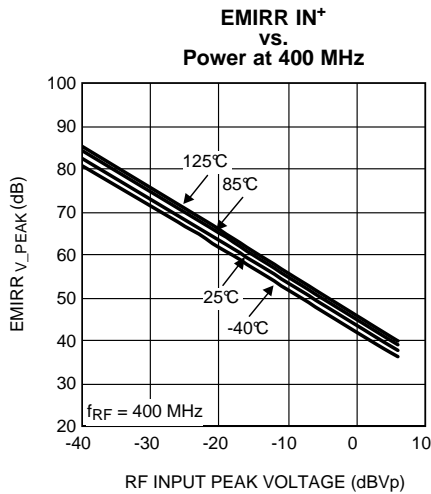

Figure 43.

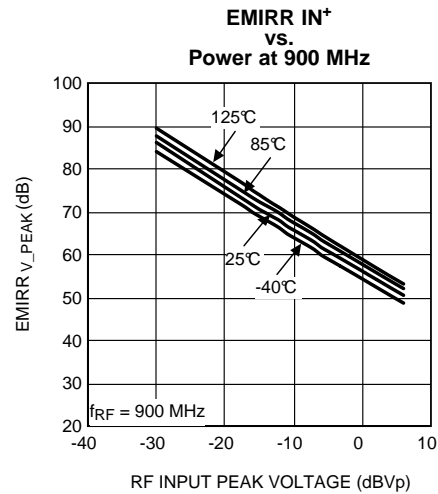

Figure 44.

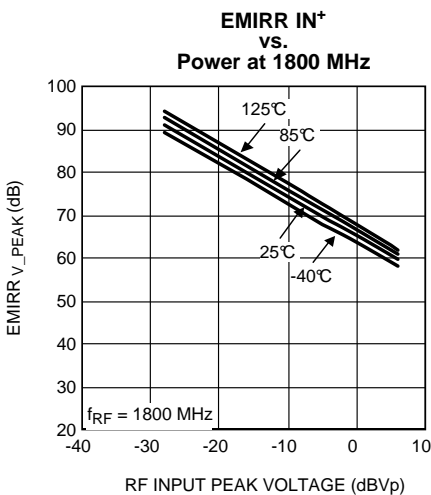

Figure 45.

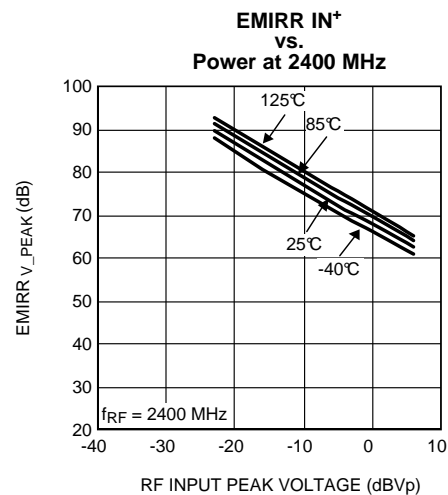
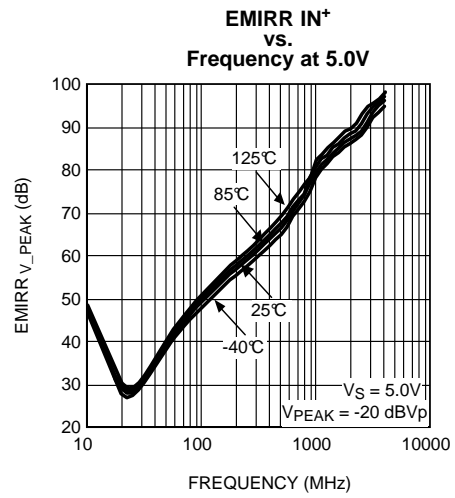
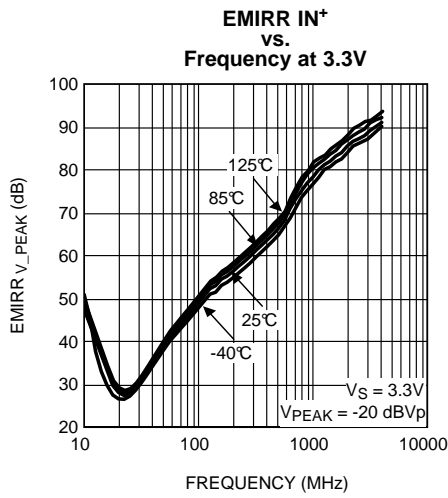

Figure 46.

Typical Performance Characteristics (continued)

At $T_A = 25^\circ\text{C}$, $R_L = 10\text{ k}\Omega$, $V_S = 3.3\text{V}$, unless otherwise specified.



APPLICATION INFORMATION

INTRODUCTION

The LMV851/LMV852/LMV854 are operational amplifiers with very good specifications, such as low offset, low noise and a rail-to-rail output. These specifications make the LMV851/LMV852/LMV854 great choices to use in areas such as medical and instrumentation. The low supply current is perfect for battery powered equipment. The small packages, SC-70 package for the LMV851, the VSSOP package for the dual LMV852 and the TSSOP package for the quad LMV854, make any of these parts a perfect choice for portable electronics. Additionally, the EMI hardening makes the LMV851/LMV852 or LMV854 a must for almost all op amp applications. Most applications are exposed to Radio Frequency (RF) signals such as the signals transmitted by mobile phones or wireless computer peripherals. The LMV851/LMV852/LMV854 will effectively reduce disturbances caused by RF signals to a level that will be hardly noticeable. This again reduces the need for additional filtering and shielding. Using this EMI resistant series of op amps will thus reduce the number of components and space needed for applications that are affected by EMI, and will help applications, not yet identified as possible EMI sensitive, to be more robust for EMI.

INPUT CHARACTERISTICS

The input common mode voltage range of the LMV851/LMV852/LMV854 includes ground, and can even sense well below ground. The CMRR level does not degrade for input levels up to 1.2V below the supply voltage. For a supply voltage of 5V, the maximum voltage that should be applied to the input for best CMRR performance is thus 3.8V.

When not configured as unity gain, this input limitation will usually not degrade the effective signal range. The output is rail-to-rail and therefore will introduce no limitations to the signal range.

The typical offset is only 0.26 mV, and the TCV_{OS} is 0.4 $\mu\text{V}/^\circ\text{C}$, specifications close to precision op amps.

CMRR MEASUREMENT

The CMRR measurement results may need some clarification. This is because different setups are used to measure the AC CMRR and the DC CMRR.

The DC CMRR is derived from ΔV_{OS} versus ΔV_{CM} . This value is stated in the tables, and is tested during production testing.

The AC CMRR is measured with the test circuit shown in [Figure 49](#).

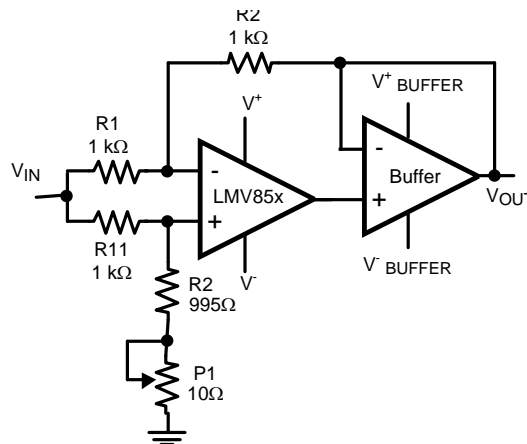

Figure 49. AC CMRR Measurement Setup

The configuration is largely the usually applied balanced configuration. With potentiometer P1, the balance can be tuned to compensate for the DC offset in the DUT. The main difference is the addition of the buffer. This buffer prevents the open-loop output impedance of the DUT from affecting the balance of the feedback network. Now the closed-loop output impedance of the buffer is a part of the balance. But as the closed-loop output impedance is much lower, and by careful selection of the buffer also has a larger bandwidth, the total effect is that the CMRR of the DUT can be measured much more accurately. The differences are apparent in the larger measured bandwidth of the AC CMRR.

One artifact from this test circuit is that the low frequency CMRR results appear higher than expected. This is because in the AC CMRR test circuit the potentiometer is used to compensate for the DC mismatches. So, mainly AC mismatch is all that remains. Therefore, the obtained DC CMRR from this AC CMRR test circuit tends to be higher than the actual DC CMRR based on DC measurements.

The CMRR curve in Figure 50 shows a combination of the AC CMRR and the DC CMRR.

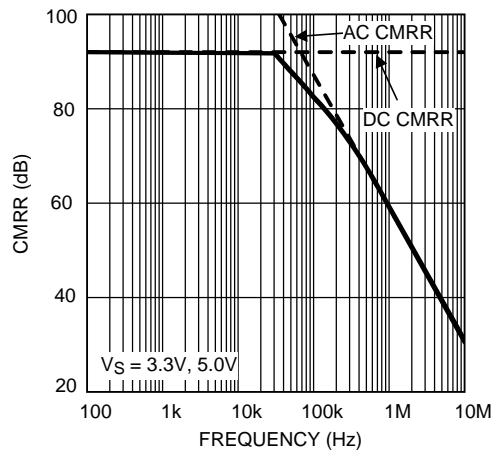

Figure 50. CMRR Curve

OUTPUT CHARACTERISTICS

As already mentioned the output is rail to rail. When loading the output with a 10 kΩ resistor the maximum swing of the output is typically 7 mV from the positive and negative rail

The LMV851/LMV852/LMV854 can be connected as non-inverting unity gain amplifiers. This configuration is the most sensitive to capacitive loading. The combination of a capacitive load placed at the output of an amplifier along with the amplifier's output impedance creates a phase lag, which reduces the phase margin of the amplifier. If the phase margin is significantly reduced, the response will be under damped which causes peaking in the transfer and, when there is too much peaking, the op amp might start oscillating. The LMV851/LMV852/LMV854 can directly drive capacitive loads up to 200 pF without any stability issues. In order to drive heavier capacitive loads, an isolation resistor, R_{ISO} , should be used, as shown in Figure 51. By using this isolation resistor, the capacitive load is isolated from the amplifier's output, and hence, the pole caused by C_L is no longer in the feedback loop. The larger the value of R_{ISO} , the more stable the amplifier will be. If the value of R_{ISO} is sufficiently large, the feedback loop will be stable, independent of the value of C_L . However, larger values of R_{ISO} result in reduced output swing and reduced output current drive.

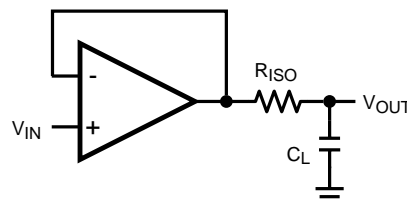

Figure 51. Isolating Capacitive Load

EMIRR

With the increase of RF transmitting devices in the world, the electromagnetic interference (EMI) between those devices and other equipment becomes a bigger challenge. The LMV851/LMV852/LMV854 are EMI hardened op amps which are specifically designed to overcome electromagnetic interference. Along with EMI hardened op amps, the EMIRR parameter is introduced to unambiguously specify the EMI performance of an op amp. This section presents an overview of EMIRR. A detailed description on this specification for EMI hardened op amps can be found in Application Note AN-1698([SNOA497](#)).

The dimensions of an op amp IC are relatively small compared to the wavelength of the disturbing RF signals. As a result the op amp itself will hardly receive any disturbances. The RF signals interfering with the op amp are dominantly received by the PCB and wiring connected to the op amp. As a result the RF signals on the pins of the op amp can be represented by voltages and currents. This representation significantly simplifies the unambiguous measurement and specification of the EMI performance of an op amp.

RF signals interfere with op amps via the non-linearity of the op amp circuitry. This non-linearity results in the detection of the so called out-of-band signals. The obtained effect is that the amplitude modulation of the out-of-band signal is down-converted into the base band. This base band can easily overlap with the band of the op amp circuit. As an example [Figure 52](#) depicts a typical output signal of a unity-gain connected op amp in the presence of an interfering RF signal. Clearly the output voltage varies in the rhythm of the on-off keying of the RF carrier.

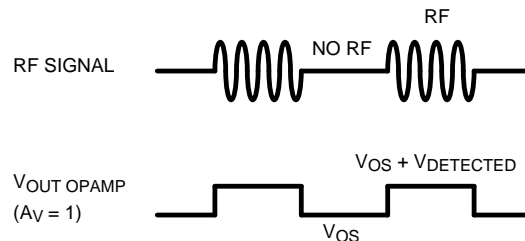

Figure 52. Offset Voltage Variation Due to an Interfering RF Signal

EMIRR Definition

To identify EMI hardened op amps, a parameter is needed that quantitatively describes the EMI performance of op amps. A quantitative measure enables the comparison and the ranking of op amps on their EMI robustness. Therefore the EMI Rejection Ratio (EMIRR) is introduced. This parameter describes the resulting input-referred offset voltage shift of an op amp as a result of an applied RF carrier (interference) with a certain frequency and level. The definition of EMIRR is given by:

$$\text{EMIRR}_{V_{\text{RF_PEAK}}} = 20 \log \left(\frac{V_{\text{RF_PEAK}}}{\Delta V_{\text{OS}}} \right) \quad (1)$$

In which $V_{\text{RF_PEAK}}$ is the amplitude of the applied un-modulated RF signal (V) and ΔV_{OS} is the resulting input-referred offset voltage shift (V). The offset voltage depends quadratically on the applied RF level, and therefore, the RF level at which the EMIRR is determined should be specified. The standard level for the RF signal is 100 mV_p. Application Note AN-1698([SNOA497](#)) addresses the conversion of an EMIRR measured for another signal level than 100 mV_p. The interpretation of the EMIRR parameter is straightforward. When two op amps have an EMIRR which differ by 20 dB, the resulting error signals when used in identical configurations, differs by 20 dB as well. So, the higher the EMIRR, the more robust the op amp.

Coupling an RF Signal to the IN⁺ Pin

Each of the op amp pins can be tested separately on EMIRR. In this section the measurements on the IN⁺ pin (which, based on symmetry considerations, also apply to the IN⁻ pin) are discussed. In Application Note AN-1698([SNOA497](#)) the other pins of the op amp are treated as well. For testing the IN⁺ pin the op amp is connected in the unity gain configuration. Applying the RF signal is straightforward as it can be connected directly to the IN⁺ pin. As a result the RF signal path has a minimum of components that might affect the RF signal level at the pin. The circuit diagram is shown in [Figure 53](#). The PCB trace from RF_{IN} to the IN⁺ pin should

be a 50Ω stripline in order to match the RF impedance of the cabling and the RF generator. On the PCB a 50Ω termination is used. This 50Ω resistor is also used to set the bias level of the IN+ pin to ground level. For determining the EMIRR, two measurements are needed: one is measuring the DC output level when the RF signal is off; and the other is measuring the DC output level when the RF signal is switched on. The difference of the two DC levels is the output voltage shift as a result of the RF signal. As the op amp is in the unity gain configuration, the input referred offset voltage shift corresponds one-to-one to the measured output voltage shift.

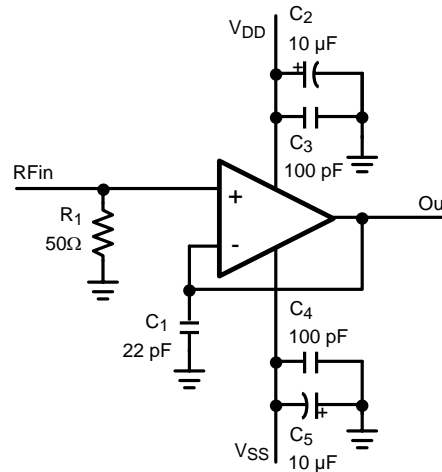

Figure 53. Circuit for Coupling the RF Signal to IN+

Cell Phone Call

The effect of electromagnetic interference is demonstrated in a setup where a cell phone interferes with a pressure sensor application (Figure 55). This application needs two op amps and therefore a dual op amp is used. The experiment is performed on two different dual op amps: a typical standard op amp and the LMV852, EMI hardened dual op amp. The op amps are placed in a single supply configuration. The cell phone is placed on a fixed position a couple of centimeters from the op amps.

When the cell phone is called, the PCB and wiring connected to the op amps receive the RF signal. Subsequently, the op amps detect the RF voltages and currents that end up at their pins. The resulting effect on the output of the second op amp is shown in Figure 54.

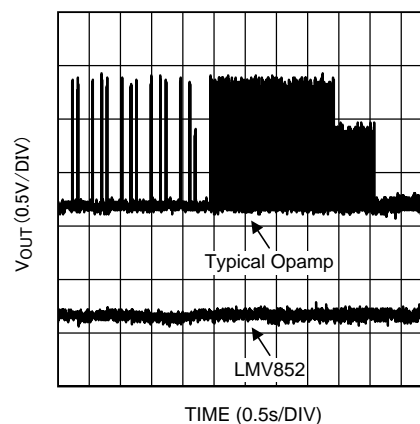

Figure 54. Comparing EMI Robustness

The difference between the two types of dual op amps is clearly visible. The typical standard dual op amp has an output shift (disturbed signal) larger than 1V as a result of the RF signal transmitted by the cell phone. The LMV852, EMI hardened op amp does not show any significant disturbances.

DECOUPLING AND LAYOUT

Care must be given when creating a board layout for the op amp. For decoupling the supply lines it is suggested that 10 nF capacitors be placed as close as possible to the op amp. For single supply, place a capacitor between V^+ and V^- . For dual supplies, place one capacitor between V^+ and the board ground, and a second capacitor between ground and V^- . Even with the LMV851/LMV852/LMV854 inherent hardening against EMI, it is still recommended to keep the input traces short and as far as possible from RF sources. Then the RF signals entering the chip are as low as possible, and the remaining EMI can be, almost, completely eliminated in the chip by the EMI reducing features of the LMV851/LMV852/LMV854.

PRESSURE SENSOR APPLICATION

The LMV851/LMV852/LMV854 can be used for pressure sensor applications. Because of their low power the LMV851/LMV852/LMV854 are ideal for portable applications, such as blood pressure measurement devices, or portable barometers. This example describes a universal pressure sensor that can be used as a starting point for different types of sensors and applications.

Pressure Sensor Characteristics

The pressure sensor used in this example functions as a Wheatstone bridge. The value of the resistors in the bridge change when pressure is applied to the sensor. This change of the resistor values will result in a differential output voltage, depending on the sensitivity of the sensor and the applied pressure. The difference between the output at full scale pressure and the output at zero pressure is defined as the span of the pressure sensor. A typical value for the span is 100 mV. A typical value for the resistors in the bridge is 5 k Ω . Loading of the resistor bridge could result in incorrect output voltages of the sensor. Therefore the selection of the circuit configuration, which connects to the sensor, should take into account a minimum loading of the sensor.

Pressure Sensor Example

The configuration shown in [Figure 55](#) is simple, and is very useful for the read out of pressure sensors. With two op amps in this application, the dual LMV852 fits very well.

The op amp configured as a buffer and connected at the negative output of the pressure sensor prevents the loading of the bridge by resistor R2. The buffer also prevents the resistors of the sensor from affecting the gain of the following gain stage. Given the differential output voltage V_S of the pressure sensor, the output signal of this op amp configuration, V_{OUT} , equals:

$$V_{OUT} = \frac{V_{DD}}{2} - \frac{V_S}{2} \left(1 + 2 \times \frac{R1}{R2} \right) \quad (2)$$

To align the pressure range with the full range of an ADC, the power supply voltage and the span of the pressure sensor are needed. For this example a power supply of 5V is used and the span of the sensor is 100 mV.

When a 100 Ω resistor is used for R2, and a 2.4 k Ω resistor is used for R1, the maximum voltage at the output is 4.95V and the minimum voltage is 0.05V. This signal is covering almost the full input range of the ADC. Further processing can take place in the microprocessor following the ADC.

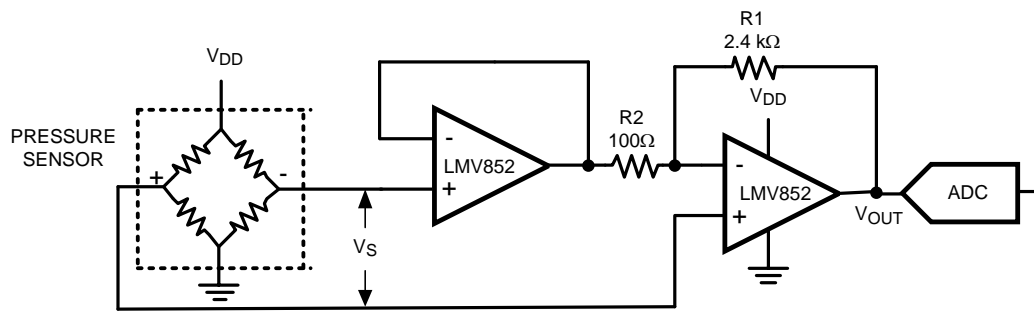

Figure 55. Pressure Sensor Application

THERMOCOUPLE AMPLIFIER

The following circuit is a typical example for a thermocouple amplifier application using an LMV851/LMV852, or LMV854. A thermocouple converts a temperature into a voltage. This signal is then amplified by the LMV851/LMV852, or LMV854. An ADC can convert the amplified signal to a digital signal. For further processing the digital signal can be processed by a microprocessor and used to display or log the temperature. The temperature data can for instance be used in a fabrication process.

Characteristics of a Thermocouple

A thermocouple is a junction of two different metals. These metals produce a small voltage that increases with temperature.

The thermocouple used in this application is a K-type thermocouple. A K-type thermocouple is a junction between Nickel-Chromium and Nickel-Aluminum. This is one of the most commonly used thermocouples. There are several reasons for using the K-type thermocouple, these include: temperature range, the linearity, the sensitivity, and the cost.

A K-type thermocouple has a wide temperature range. The range of this thermocouple is from approximately -200°C to approximately 1200°C , as can be seen in [Figure 56](#). This covers the generally used temperature ranges.

Over the main part of the temperature range the output voltage depends linearly on the temperature. This is important for easily converting the measured signal levels to a temperature reading.

The K-type thermocouple has good sensitivity when compared to many other types; the sensitivity is about $41\ \mu\text{V}/^{\circ}\text{C}$. Lower sensitivity requires more gain and makes the application more sensitive to noise.

In addition, a K-type thermocouple is not expensive, many other thermocouples consist of more expensive materials or are more difficult to produce.

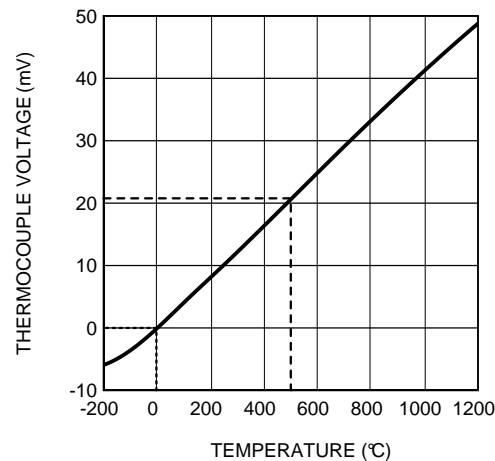

Figure 56. K-Type Thermocouple Response

Thermocouple Example

For this example, suppose the range of interest is 0°C to 500°C, and the resolution needed is 0.5°C. The power supply for both the LMV851/LMV852, or LMV854 and the ADC is 3.3V.

The temperature range of 0°C to 500°C results in a voltage range from 0 mV to 20.6 mV produced by the thermocouple. This is indicated in Figure 56 by the dotted lines.

To obtain the highest resolution, the full ADC range of 0 to 3.3V is used. The gain needed for the full range can be calculated as follows:

$$A_V = 3.3V / 0.0206V = 160 \quad (3)$$

If R_G is 2 k Ω , then the value for R_F can be calculated for a gain of 160. Since $A_V = R_F / R_G$, R_F can be calculated as follows:

$$R_F = A_V \times R_G = 160 \times 2 \text{ k}\Omega = 320 \text{ k}\Omega \quad (4)$$

To get a resolution of 0.5°C, the LSB of the ADC should be smaller than $0.5^\circ\text{C} / 500^\circ\text{C} = 1/1000$. A 10-bit ADC would be sufficient as this gives 1024 steps. A 10-bit ADC such as the two channel 10-bit ADC102S021 can be used.

Unwanted Thermocouple Effect

At the point where the thermocouple wires are connected to the circuit, usually copper wires or traces, an unwanted thermocouple effect will occur.

At this connection, this could be the connector on a PCB, the thermocouple wiring forms a second thermocouple with the connector. This second thermocouple disturbs the measurements from the intended thermocouple.

Using an isothermal block as a reference enables correction for this unwanted thermocouple effect. An isothermal block is a good heat conductor. This means that the two thermocouple connections both have the same temperature. The temperature of the isothermal block can be measured, and thereby the temperature of the thermocouple connections. This is usually called the cold junction reference temperature.

In the example, an LM35 is used to measure this temperature. This semiconductor temperature sensor can accurately measure temperatures from -55°C to 150°C .

The two channel ADC in this example also converts the signal from the LM35 to a digital signal. Now the microprocessor can compensate the amplified thermocouple signal, for the unwanted thermocouple effect.

REVISION HISTORY

Changes from Original (March 2013) to Revision D

Page

PACKAGING INFORMATION

Orderable Device	Status (1)	Package Type	Package Drawing	Pins	Package Qty	Eco Plan (2)	Lead/Ball Finish (6)	MSL Peak Temp (3)	Op Temp (°C)	Device Marking (4/5)	Samples
LMV851MG/NOPB	ACTIVE	SC70	DCK	5	1000	Green (RoHS & no Sb/Br)	CU SN	Level-1-260C-UNLIM	-40 to 125	A98	Samples
LMV851MGE/NOPB	ACTIVE	SC70	DCK	5	250	Green (RoHS & no Sb/Br)	CU SN	Level-1-260C-UNLIM	-40 to 125	A98	Samples
LMV851MGX/NOPB	ACTIVE	SC70	DCK	5	3000	Green (RoHS & no Sb/Br)	CU SN	Level-1-260C-UNLIM	-40 to 125	A98	Samples
LMV852MM/NOPB	ACTIVE	VSSOP	DGK	8	1000	Green (RoHS & no Sb/Br)	CU NIPDAUAG CU SN	Level-1-260C-UNLIM	-40 to 125	AB5A	Samples
LMV852MME/NOPB	ACTIVE	VSSOP	DGK	8	250	Green (RoHS & no Sb/Br)	CU NIPDAUAG CU SN	Level-1-260C-UNLIM	-40 to 125	AB5A	Samples
LMV852MMX/NOPB	ACTIVE	VSSOP	DGK	8	3500	Green (RoHS & no Sb/Br)	CU NIPDAUAG CU SN	Level-1-260C-UNLIM	-40 to 125	AB5A	Samples
LMV854MT/NOPB	ACTIVE	TSSOP	PW	14	94	Green (RoHS & no Sb/Br)	CU SN	Level-1-260C-UNLIM	-40 to 125	LMV854 MT	Samples
LMV854MTX/NOPB	ACTIVE	TSSOP	PW	14	2500	Green (RoHS & no Sb/Br)	CU SN	Level-1-260C-UNLIM	-40 to 125	LMV854 MT	Samples

(1) The marketing status values are defined as follows:

ACTIVE: Product device recommended for new designs.

LIFEBUY: TI has announced that the device will be discontinued, and a lifetime-buy period is in effect.

NRND: Not recommended for new designs. Device is in production to support existing customers, but TI does not recommend using this part in a new design.

PREVIEW: Device has been announced but is not in production. Samples may or may not be available.

OBSOLETE: TI has discontinued the production of the device.

(2) Eco Plan - The planned eco-friendly classification: Pb-Free (RoHS), Pb-Free (RoHS Exempt), or Green (RoHS & no Sb/Br) - please check <http://www.ti.com/productcontent> for the latest availability information and additional product content details.

TBD: The Pb-Free/Green conversion plan has not been defined.

Pb-Free (RoHS): TI's terms "Lead-Free" or "Pb-Free" mean semiconductor products that are compatible with the current RoHS requirements for all 6 substances, including the requirement that lead not exceed 0.1% by weight in homogeneous materials. Where designed to be soldered at high temperatures, TI Pb-Free products are suitable for use in specified lead-free processes.

Pb-Free (RoHS Exempt): This component has a RoHS exemption for either 1) lead-based flip-chip solder bumps used between the die and package, or 2) lead-based die adhesive used between the die and leadframe. The component is otherwise considered Pb-Free (RoHS compatible) as defined above.

Green (RoHS & no Sb/Br): TI defines "Green" to mean Pb-Free (RoHS compatible), and free of Bromine (Br) and Antimony (Sb) based flame retardants (Br or Sb do not exceed 0.1% by weight in homogeneous material)

(3) MSL, Peak Temp. - The Moisture Sensitivity Level rating according to the JEDEC industry standard classifications, and peak solder temperature.

(4) There may be additional marking, which relates to the logo, the lot trace code information, or the environmental category on the device.

(5) Multiple Device Markings will be inside parentheses. Only one Device Marking contained in parentheses and separated by a "~" will appear on a device. If a line is indented then it is a continuation of the previous line and the two combined represent the entire Device Marking for that device.

(6) Lead/Ball Finish - Orderable Devices may have multiple material finish options. Finish options are separated by a vertical ruled line. Lead/Ball Finish values may wrap to two lines if the finish value exceeds the maximum column width.

Important Information and Disclaimer:The information provided on this page represents TI's knowledge and belief as of the date that it is provided. TI bases its knowledge and belief on information provided by third parties, and makes no representation or warranty as to the accuracy of such information. Efforts are underway to better integrate information from third parties. TI has taken and continues to take reasonable steps to provide representative and accurate information but may not have conducted destructive testing or chemical analysis on incoming materials and chemicals. TI and TI suppliers consider certain information to be proprietary, and thus CAS numbers and other limited information may not be available for release.

In no event shall TI's liability arising out of such information exceed the total purchase price of the TI part(s) at issue in this document sold by TI to Customer on an annual basis.

TAPE AND REEL INFORMATION

QUADRANT ASSIGNMENTS FOR PIN 1 ORIENTATION IN TAPE

*All dimensions are nominal

Device	Package Type	Package Drawing	Pins	SPQ	Reel Diameter (mm)	Reel Width W1 (mm)	A0 (mm)	B0 (mm)	K0 (mm)	P1 (mm)	W (mm)	Pin1 Quadrant
LMV851MG/NOPB	SC70	DCK	5	1000	178.0	8.4	2.25	2.45	1.2	4.0	8.0	Q3
LMV851MGE/NOPB	SC70	DCK	5	250	178.0	8.4	2.25	2.45	1.2	4.0	8.0	Q3
LMV851MGX/NOPB	SC70	DCK	5	3000	178.0	8.4	2.25	2.45	1.2	4.0	8.0	Q3
LMV852MM/NOPB	VSSOP	DGK	8	1000	178.0	13.4	5.3	3.4	1.4	8.0	12.0	Q1
LMV852MM/NOPB	VSSOP	DGK	8	1000	178.0	12.4	5.3	3.4	1.4	8.0	12.0	Q1
LMV852MME/NOPB	VSSOP	DGK	8	250	178.0	12.4	5.3	3.4	1.4	8.0	12.0	Q1
LMV852MMX/NOPB	VSSOP	DGK	8	3500	330.0	12.4	5.3	3.4	1.4	8.0	12.0	Q1
LMV852MMX/NOPB	VSSOP	DGK	8	3500	330.0	12.4	5.3	3.4	1.4	8.0	12.0	Q1
LMV854MTX/NOPB	TSSOP	PW	14	2500	330.0	12.4	6.95	5.6	1.6	8.0	12.0	Q1

TAPE AND REEL BOX DIMENSIONS

*All dimensions are nominal

Device	Package Type	Package Drawing	Pins	SPQ	Length (mm)	Width (mm)	Height (mm)
LMV851MG/NOPB	SC70	DCK	5	1000	210.0	185.0	35.0
LMV851MGE/NOPB	SC70	DCK	5	250	210.0	185.0	35.0
LMV851MGX/NOPB	SC70	DCK	5	3000	210.0	185.0	35.0
LMV852MM/NOPB	VSSOP	DGK	8	1000	202.0	201.0	28.0
LMV852MM/NOPB	VSSOP	DGK	8	1000	210.0	185.0	35.0
LMV852MME/NOPB	VSSOP	DGK	8	250	210.0	185.0	35.0
LMV852MMX/NOPB	VSSOP	DGK	8	3500	367.0	367.0	35.0
LMV852MMX/NOPB	VSSOP	DGK	8	3500	364.0	364.0	27.0
LMV854MTX/NOPB	TSSOP	PW	14	2500	367.0	367.0	35.0

DCK (R-PDSO-G5)

PLASTIC SMALL-OUTLINE PACKAGE



- NOTES:
- All linear dimensions are in millimeters.
 - This drawing is subject to change without notice.
 - Body dimensions do not include mold flash or protrusion. Mold flash and protrusion shall not exceed 0.15 per side.
 - Falls within JEDEC MO-203 variation AA.

DCK (R-PDSO-G5)

PLASTIC SMALL OUTLINE

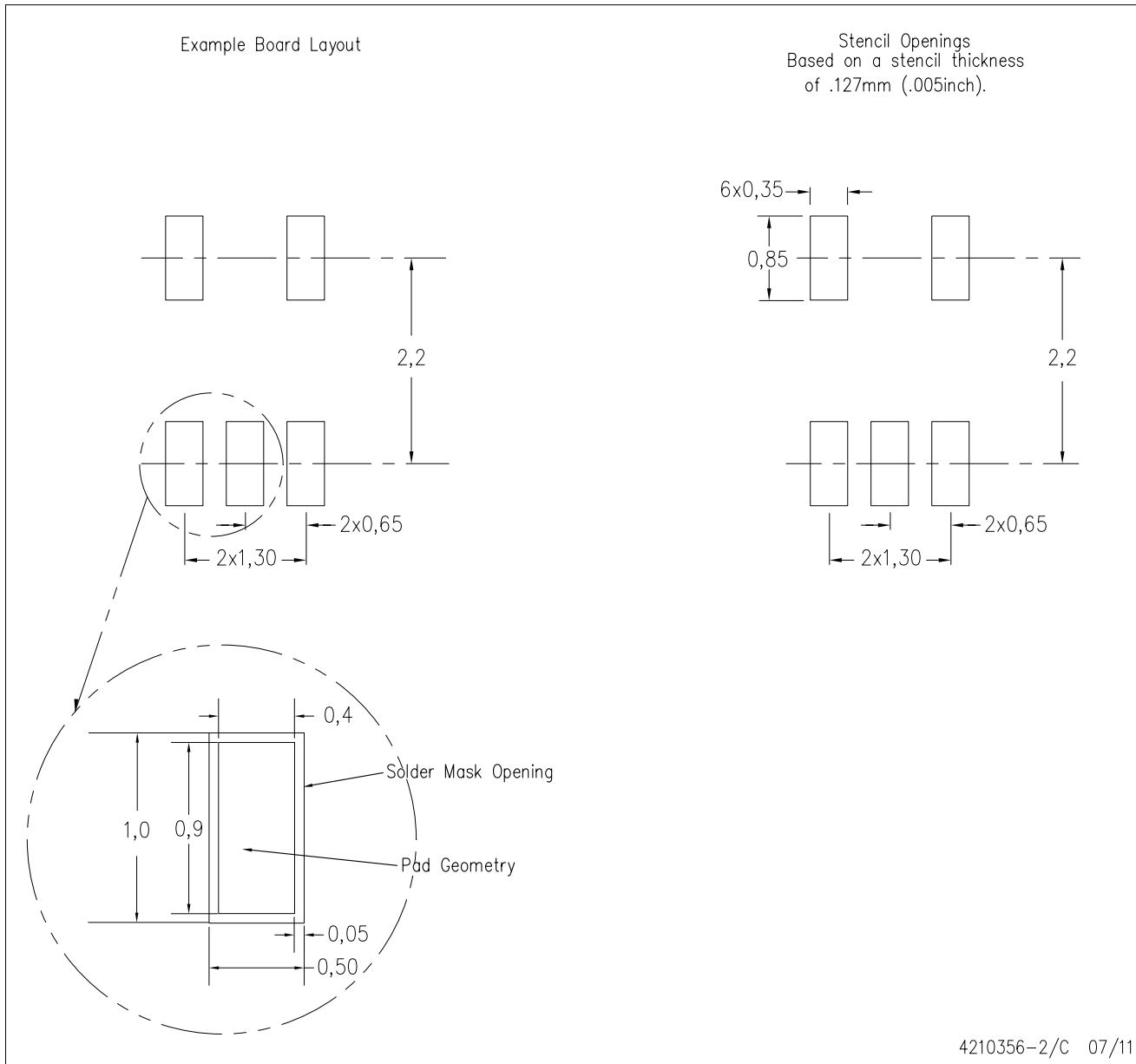

- NOTES:
- All linear dimensions are in millimeters.
 - This drawing is subject to change without notice.
 - Customers should place a note on the circuit board fabrication drawing not to alter the center solder mask defined pad.
 - Publication IPC-7351 is recommended for alternate designs.
 - Laser cutting apertures with trapezoidal walls and also rounding corners will offer better paste release. Customers should contact their board assembly site for stencil design recommendations. Example stencil design based on a 50% volumetric metal load solder paste. Refer to IPC-7525 for other stencil recommendations.

PW (R-PDSO-G14)

PLASTIC SMALL OUTLINE



4040064-3/G 02/11

- NOTES:
- A. All linear dimensions are in millimeters. Dimensioning and tolerancing per ASME Y14.5M-1994.
 - B. This drawing is subject to change without notice.
 - C. Body length does not include mold flash, protrusions, or gate burrs. Mold flash, protrusions, or gate burrs shall not exceed 0,15 each side.
 - D. Body width does not include interlead flash. Interlead flash shall not exceed 0,25 each side.
 - E. Falls within JEDEC MO-153

PW (R-PDSO-G14)

PLASTIC SMALL OUTLINE



4211284-2/G 08/15

- NOTES:
- All linear dimensions are in millimeters.
 - This drawing is subject to change without notice.
 - Publication IPC-7351 is recommended for alternate designs.
 - Laser cutting apertures with trapezoidal walls and also rounding corners will offer better paste release. Customers should contact their board assembly site for stencil design recommendations. Refer to IPC-7525 for other stencil recommendations.
 - Customers should contact their board fabrication site for solder mask tolerances between and around signal pads.

DGK (S-PDSO-G8)

PLASTIC SMALL-OUTLINE PACKAGE

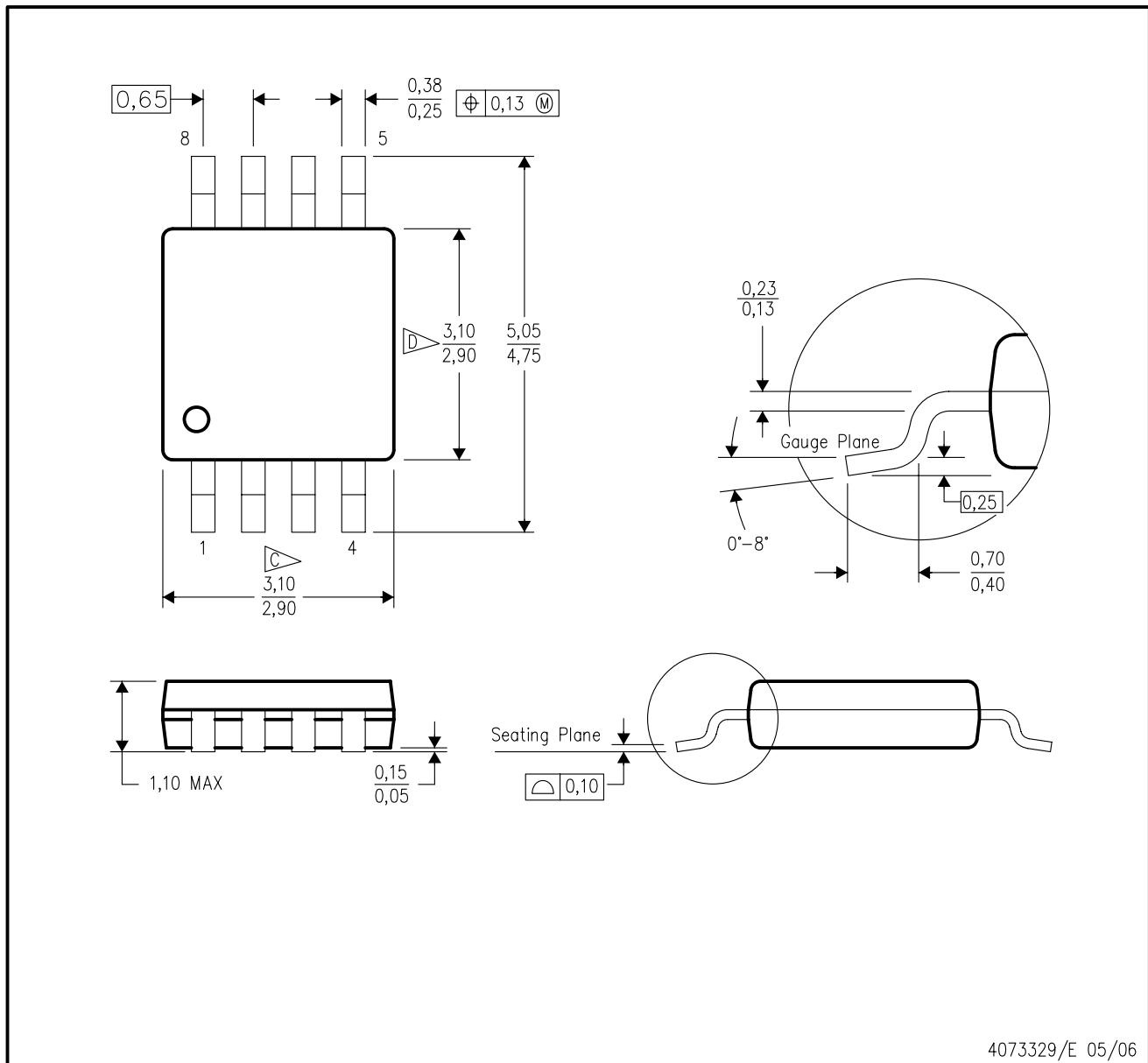

- NOTES:
- A. All linear dimensions are in millimeters.
 - B. This drawing is subject to change without notice.
 - C. Body length does not include mold flash, protrusions, or gate burrs. Mold flash, protrusions, or gate burrs shall not exceed 0.15 per end.
 - D. Body width does not include interlead flash. Interlead flash shall not exceed 0.50 per side.
 - E. Falls within JEDEC MO-187 variation AA, except interlead flash.



- NOTES:
- A. All linear dimensions are in millimeters.
 - B. This drawing is subject to change without notice.
 - C. Publication IPC-7351 is recommended for alternate designs.
 - D. Laser cutting apertures with trapezoidal walls and also rounding corners will offer better paste release. Customers should contact their board assembly site for stencil design recommendations. Refer to IPC-7525 for other stencil recommendations.
 - E. Customers should contact their board fabrication site for solder mask tolerances between and around signal pads.

IMPORTANT NOTICE AND DISCLAIMER

TI PROVIDES TECHNICAL AND RELIABILITY DATA (INCLUDING DATASHEETS), DESIGN RESOURCES (INCLUDING REFERENCE DESIGNS), APPLICATION OR OTHER DESIGN ADVICE, WEB TOOLS, SAFETY INFORMATION, AND OTHER RESOURCES "AS IS" AND WITH ALL FAULTS, AND DISCLAIMS ALL WARRANTIES, EXPRESS AND IMPLIED, INCLUDING WITHOUT LIMITATION ANY IMPLIED WARRANTIES OF MERCHANTABILITY, FITNESS FOR A PARTICULAR PURPOSE OR NON-INFRINGEMENT OF THIRD PARTY INTELLECTUAL PROPERTY RIGHTS.

These resources are intended for skilled developers designing with TI products. You are solely responsible for (1) selecting the appropriate TI products for your application, (2) designing, validating and testing your application, and (3) ensuring your application meets applicable standards, and any other safety, security, or other requirements. These resources are subject to change without notice. TI grants you permission to use these resources only for development of an application that uses the TI products described in the resource. Other reproduction and display of these resources is prohibited. No license is granted to any other TI intellectual property right or to any third party intellectual property right. TI disclaims responsibility for, and you will fully indemnify TI and its representatives against, any claims, damages, costs, losses, and liabilities arising out of your use of these resources.

TI's products are provided subject to TI's Terms of Sale (www.ti.com/legal/termsofsale.html) or other applicable terms available either on ti.com or provided in conjunction with such TI products. TI's provision of these resources does not expand or otherwise alter TI's applicable warranties or warranty disclaimers for TI products.

Mailing Address: Texas Instruments, Post Office Box 655303, Dallas, Texas 75265
Copyright © 2019, Texas Instruments Incorporated

Looking for pricing, stock, or lifecycle information?

Click below to explore more details on WIN SOURCE:

 [View LMV854MTX/NOPB on WIN SOURCE](#)

 [Texas Instruments](#) Information

Optimize Your Supply Chain with WIN SOURCE Solutions

-  Global Sourcing Solution
-  Obsolete Management
-  Cost Control Management
-  Shortage Management
-  Alternative Solution
-  Excess Inventory Management