



**THE DATASHEET OF  
MAX4330EUK-T**





# Single/Dual/Quad, Low-Power, Single-Supply, Rail-to-Rail I/O Op Amps with Shutdown

MAX4330-MAX4334

## General Description

The MAX4330-MAX4334 single/dual/quad op amps combine a wide 3MHz bandwidth, low-power operation, and excellent DC accuracy with Rail-to-Rail® inputs and outputs. These devices require only 245µA per amplifier, and operate from either a single +2.3V to +6.5V supply or dual ±1.15V to ±3.25V supplies. The input common-mode voltage range extends 250mV beyond V<sub>EE</sub> and V<sub>CC</sub>, and the outputs swing rail-to-rail. The MAX4331/MAX4333 feature a shutdown mode in which the output goes high impedance and the supply current decreases to 9µA per amplifier.

Low-power operation combined with rail-to-rail input common-mode range and output swing makes these amplifiers ideal for portable/battery-powered equipment and other low-voltage, single-supply applications. Although the minimum operating voltage is specified at 2.3V, these devices typically operate down to 2.0V. Low offset voltage and high speed make these amplifiers excellent choices for signal-conditioning stages in precision, low-voltage data-acquisition systems. The MAX4330 is available in the space-saving 5-pin SOT23 package, and the MAX4331/MAX4333 are offered in a µMAX package.

## Applications

Portable/Battery-Powered Equipment  
 Data-Acquisition Systems  
 Signal Conditioning  
 Low-Power, Low-Voltage Applications

## Selector Guide

PART	NO. OF AMPS PER PACKAGE	SHUTDOWN MODE	PIN-PACKAGE
MAX4330	1	—	5-pin SOT23
MAX4331	1	Yes	8-pin SO/µMAX
MAX4332	2	—	8-pin SO
MAX4333	2	Yes	10-pin µMAX, 14-pin SO
MAX4334	4	—	14-pin SO

Rail-to-Rail is a registered trademark of Nippon Motorola Ltd.



## Features

- ◆ 3MHz Gain-Bandwidth Product
- ◆ 245µA Quiescent Current per Amplifier
- ◆ Available in Space-Saving SOT23-5 Package (MAX4330)
- ◆ +2.3V to +6.5V Single-Supply Operation
- ◆ Rail-to-Rail Input Common-Mode Voltage Range
- ◆ Rail-to-Rail Output Voltage Swing
- ◆ 250µV Offset Voltage
- ◆ Low-Power, 9µA (per amp) Shutdown Mode (MAX4331/MAX4333)
- ◆ No Phase Reversal for Overdriven Inputs
- ◆ Capable of Driving 2kΩ Loads
- ◆ Unity-Gain Stable

## Ordering Information

PART	TEMP. RANGE	PIN-PACKAGE	SOT TOP MARK
MAX4330EUK-T	-40°C to +85°C	5 SOT23-5	ABAJ
MAX4331ESA	-40°C to +85°C	8 SO	—
MAX4331EUA	-40°C to +85°C	8 µMAX	—
MAX4332ESA	-40°C to +85°C	8 SO	—
MAX4333ESD	-40°C to +85°C	14 SO	—
MAX4333EUB	-40°C to +85°C	10 µMAX	—
MAX4334ESD	-40°C to +85°C	14 SO	—

## Pin Configurations

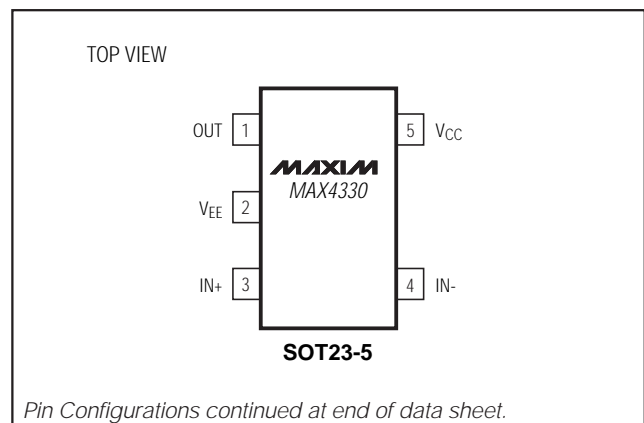

# Single/Dual/Quad, Low-Power, Single-Supply, Rail-to-Rail I/O Op Amps with Shutdown

## ABSOLUTE MAXIMUM RATINGS

Supply Voltage, $V_{CC}$ to $V_{EE}$ .....	7V	10-Pin $\mu$ MAX (derate 5.60mW/°C above +70°C) .....	444mW
$IN_+$ , $IN_-$ , $\overline{SHDN}$ Voltage.....( $V_{EE} - 0.3V$ ) to ( $V_{CC} + 0.3V$ )		14-Pin SO (derate 8.33mW/°C above +70°C).....	667mW
Output Short-Circuit Duration..... Continuous		Operating Temperature Ranges	
(short to either supply)		MAX433_C/D .....	0°C to +70°C
Continuous Power Dissipation ( $T_A = +70^\circ C$ )		MAX433_E_.....	-40°C to +85°C
5-Pin SOT23 (derate 7.1mW/°C above +70°C).....	571mW	Maximum Junction Temperature .....	+150°C
8-Pin SO (derate 5.88mW/°C above +70°C).....	471mW	Storage Temperature Range .....	-65°C to +160°C
8-Pin $\mu$ MAX (derate 4.10mW/°C above +70°C) .....	330mW	Lead Temperature (soldering, 10sec) .....	+300°C

Stresses beyond those listed under "Absolute Maximum Ratings" may cause permanent damage to the device. These are stress ratings only, and functional operation of the device at these or any other conditions beyond those indicated in the operational sections of the specifications is not implied. Exposure to absolute maximum rating conditions for extended periods may affect device reliability.

## DC ELECTRICAL CHARACTERISTICS

( $V_{CC} = +2.3V$  to  $+6.5V$ ,  $V_{EE} = 0V$ ,  $V_{CM} = 0V$ ,  $V_{OUT} = (V_{CC} / 2)$ ,  $R_L$  tied to ( $V_{CC} / 2$ ),  $V_{\overline{SHDN}} \geq 2V$ ,  $T_A = +25^\circ C$ , unless otherwise noted.)

PARAMETER	SYMBOL	CONDITIONS		MIN	TYP	MAX	UNITS
Input Offset Voltage	$V_{OS}$	$V_{CM} = V_{EE}$ to $V_{CC}$	MAX433_EUA/EUB		$\pm 0.65$	$\pm 1.5$	mV
			MAX4330EUK		$\pm 0.65$	$\pm 1.5$	
			MAX4331ESA		$\pm 0.25$	$\pm 0.6$	
			MAX4332ESA/MAX4333ESD		$\pm 0.25$	$\pm 0.9$	
			MAX4334ESD		$\pm 0.25$	$\pm 1.0$	
Input Bias Current	$I_B$	$V_{EE} < V_{CM} < V_{CC}$		$\pm 25$	$\pm 65$	nA	
Input Offset Current	$I_{OS}$	$V_{EE} < V_{CM} < V_{CC}$		$\pm 1$	$\pm 12$	nA	
Differential Input Resistance	$R_{IN(DIFF)}$	$ V_{IN+} - V_{IN-}  < 1.4V$			2.3		M $\Omega$
		$ V_{IN+} - V_{IN-}  > 2.5V$			2		k $\Omega$
Common-Mode Input Voltage Range	$V_{CM}$			-0.25		$V_{CC} + 0.25$	V
Common-Mode Rejection Ratio	CMRR	$-0.25V < V_{CM} < (V_{CC} + 0.25V)$	$V_{CC} = 5V$	MAX433_EUA/EUB	68	88	dB
				MAX4330EUK	67	87	
				MAX4331ESA	74	93	
				MAX4332ESA/MAX4333ESD	71	93	
				MAX4334ESD	69	92	
			$V_{CC} = 2.3V$	MAX433_EUA/EUB	65	84	dB
				MAX4330EUK	64	82	
				MAX4331ESA	71	90	
				MAX4332ESA/MAX4333ESD	69	90	
				MAX4334ESD	66	89	
Power-Supply Rejection Ratio	PSSR	$V_{CC} = 2.3V$ to $6.5V$	MAX433_EUA/EUB	76	88	dB	
			MAX4330EUK	76	88		
			MAX4331ESA	79	92		
			MAX4332ESA/MAX4333ESD	77	90		
			MAX4334ESD	75	90		
Output Resistance	$R_{OUT}$	$A_V = 1$			0.1	$\Omega$	
Off-Leakage Current in Shutdown	$I_{OUT(\overline{SHDN})}$	$V_{\overline{SHDN}} < 0.8V$ , $V_{OUT} = 0V$ to $V_{CC}$			$\pm 0.1$	$\pm 2$	$\mu A$

# Single/Dual/Quad, Low-Power, Single-Supply, Rail-to-Rail I/O Op Amps with Shutdown

MAX4330-MAX4334

## DC ELECTRICAL CHARACTERISTICS (continued)

( $V_{CC} = +2.3V$  to  $+6.5V$ ,  $V_{EE} = 0V$ ,  $V_{CM} = 0V$ ,  $V_{OUT} = (V_{CC} / 2)$ ,  $R_L$  tied to  $(V_{CC} / 2)$ ,  $V_{\overline{SHDN}} \geq 2V$ ,  $T_A = +25^\circ C$ , unless otherwise noted.)

PARAMETER	SYMBOL	CONDITIONS		MIN	TYP	MAX	UNITS
Large-Signal Voltage Gain	$A_{VOL}$	$V_{CC} = 2.3V$	$V_{OUT} = 0.2V$ to $2.1V$ , $R_L = 100k\Omega$	93	112		dB
			$V_{OUT} = 0.35V$ to $1.95V$ , $R_L = 2k\Omega$	78	90		
		$V_{CC} = 5V$	$V_{OUT} = 0.2V$ to $4.8V$ , $R_L = 100k\Omega$	93	120		
			$V_{OUT} = 0.35V$ to $4.65V$ , $R_L = 2k\Omega$	83	95		
Output Voltage Swing	$V_{OUT}$	$R_L = 100k\Omega$	$V_{CC} - V_{OH}$		8	30	mV
			$V_{OL}$		8	30	
		$R_L = 2k\Omega$	$V_{CC} - V_{OH}$		100	175	
			$V_{OL}$		70	150	
Output Short-Circuit Current	$I_{SC}$			20			mA
$\overline{SHDN}$ Logic Threshold (Note 1)	$V_{IL}$	Low (shutdown mode)				0.8	V
	$V_{IH}$	High (normal mode)		2.0			
$\overline{SHDN}$ Input Current		$V_{EE} < V_{\overline{SHDN}} < V_{CC}$				$\pm 2$	$\mu A$
Operating Supply-Voltage Range	$V_{CC}$			2.3		6.5	V
Quiescent Supply Current per Amplifier	$I_{CC}$	$V_{CM} = V_{OUT} = V_{CC} / 2$	$V_{CC} = 5V$		275	325	$\mu A$
			$V_{CC} = 2.3V$		245	290	
Shutdown Supply Current per Amplifier	$I_{CC}(\overline{SHDN})$	$V_{\overline{SHDN}} < 0.8V$	$V_{CC} = 5V$		17	25	$\mu A$
			$V_{CC} = 2.3V$		9	14	

## DC ELECTRICAL CHARACTERISTICS

( $V_{CC} = +2.3V$  to  $+6.5V$ ,  $V_{EE} = 0V$ ,  $V_{CM} = 0V$ ,  $V_{OUT} = (V_{CC} / 2)$ ,  $R_L$  tied to  $(V_{CC} / 2)$ ,  $V_{\overline{SHDN}} \geq 2V$ ,  $T_A = -40^\circ C$  to  $+85^\circ C$ , unless otherwise noted.)

PARAMETER	SYMBOL	CONDITIONS		MIN	TYP	MAX	UNITS
Input Offset Voltage	$V_{OS}$	$V_{CM} = V_{EE}$ to $V_{CC}$	MAX433_EUA			$\pm 3.2$	mV
			MAX433_EUK/EUB			$\pm 3.8$	
			MAX4331ESA			$\pm 0.7$	
			MAX4332ESA/MAX4333ESD			$\pm 1$	
			MAX4334ESD			$\pm 1$	
Offset-Voltage Tempco	$\Delta V_{OS}/\Delta T$				$\pm 3$		$\mu V/^\circ C$
Input Bias Current	$I_B$	$V_{EE} < V_{CM} < V_{CC}$				$\pm 115$	nA
Input Offset Current	$I_{OS}$	$V_{EE} < V_{CM} < V_{CC}$				$\pm 15$	nA
Power-Supply Rejection Ratio	PSRR	$V_{CC} = 2.3V$ to $6.5V$	MAX433_EUA	72			dB
			MAX433_EUK/EUB	71			
			MAX4331ESA	76			
			MAX4332ESA/MAX4333ESD	73			
			MAX4334ESD	71			
Common-Mode Input Voltage Range	$V_{CM}$			-0.15		$V_{CC} + 0.15$	V

# Single/Dual/Quad, Low-Power, Single-Supply, Rail-to-Rail I/O Op Amps with Shutdown

## DC ELECTRICAL CHARACTERISTICS (continued)

( $V_{CC} = +2.3V$  to  $+6.5V$ ,  $V_{EE} = 0V$ ,  $V_{CM} = 0V$ ,  $V_{OUT} = (V_{CC} / 2)$ ,  $R_L$  tied to  $(V_{CC} / 2)$ ,  $V_{\overline{SHDN}} \geq 2V$ ,  $T_A = -40^\circ C$  to  $+85^\circ C$ , unless otherwise noted.)

PARAMETER	SYMBOL	CONDITIONS		MIN	TYP	MAX	UNITS
Common-Mode Rejection Ratio	CMRR	$-0.25V < V_{CM} < (V_{CC} + 0.25V)$	$V_{CC} = 5V$	MAX433_EUA/EUB	63		dB
				MAX4330EUK	62		
				MAX4331ESA	72		
				MAX4332ESA/ MAX4333ESD	69		
				MAX4334ESD	67		
			$V_{CC} = 2.3V$	MAX433_EUA/EUB	58		
				MAX4330EUK	57		
				MAX4331ESA	68		
				MAX4332ESA/ MAX4333ESD	66		
				MAX4334ESD	65		
Off-Leakage Current in Shutdown	$I_{OUT(\overline{SHDN})}$	$V_{\overline{SHDN}} < 0.8V$ , $V_{OUT} = 0V$ to $V_{CC}$				$\pm 5$	$\mu A$
Large-Signal Voltage Gain	$A_{VOL}$	$V_{CC} = 2.3V$	$V_{OUT} = 0.2V$ to $2.1V$ , $R_L = 100k\Omega$	90			dB
			$V_{OUT} = 0.35V$ to $1.95V$ , $R_L = 2k\Omega$	70			
		$V_{CC} = 5V$	$V_{OUT} = 0.2V$ to $4.8V$ , $R_L = 100k\Omega$	90			
			$V_{OUT} = 0.35V$ to $4.65V$ , $R_L = 2k\Omega$	74			
Output Voltage Swing	$V_{OUT}$	$R_L = 100k\Omega$	$V_{CC} - V_{OH}$			40	mV
			$V_{OL}$			40	
		$R_L = 2k\Omega$	$V_{CC} - V_{OH}$			200	
			$V_{OL}$			180	
$\overline{SHDN}$ Logic Threshold (Note 1)	$V_{IL}$	Low (shutdown mode)				0.8	V
	$V_{IH}$	High (normal mode)		2.0			
$\overline{SHDN}$ Input Current		$V_{EE} < V_{\overline{SHDN}} < V_{CC}$				$\pm 2$	$\mu A$
Operating Supply-Voltage Range	$V_{CC}$	$T_A = -40^\circ C$ to $+85^\circ C$		2.3		6.5	V
Quiescent Supply Current per Amplifier	$I_{CC}$	$V_{CM} = V_{OUT} = V_{CC} / 2$		$V_{CC} = 5V$		350	$\mu A$
				$V_{CC} = 2.3V$		330	
Shutdown Supply Current per Amplifier	$I_{CC(\overline{SHDN})}$	$V_{\overline{SHDN}} < 0.8V$		$V_{CC} = 5V$		30	$\mu A$
				$V_{CC} = 2.3V$		17	

**Note 1:**  $\overline{SHDN}$  logic thresholds are referenced to  $V_{EE}$ .

**Note 2:** The MAX4330EUK is 100% tested at  $T_A = +25^\circ C$ . All temperature limits are guaranteed by design.

# Single/Dual/Quad, Low-Power, Single-Supply, Rail-to-Rail I/O Op Amps with Shutdown

MAX4330-MAX4334

## AC ELECTRICAL CHARACTERISTICS

( $V_{CC} = +5V$ ,  $V_{EE} = 0V$ ,  $V_{CM} = 0V$ ,  $V_{OUT} = (V_{CC} / 2)$ ,  $R_L = 10k\Omega$  ( $V_{CC} / 2$ ),  $V_{SHDN} \geq 2V$ ,  $C_L = 15pF$ ,  $T_A = +25^\circ C$ , unless otherwise noted.)

PARAMETER	SYMBOL	CONDITIONS	MIN	TYP	MAX	UNITS
Gain-Bandwidth Product	GBWP			3		MHz
Full-Power Bandwidth	FPBW	$V_{OUT} = 4V_{p-p}$		190		kHz
Slew Rate	SR			1.5		$V/\mu s$
Phase Margin	PM			55		degrees
Gain Margin	GM			10		dB
Total Harmonic Distortion	THD	$f = 10kHz$ , $V_{OUT} = 2V_{p-p}$ , $A_{vCL} = +1V/V$		0.012		%
Settling Time to 0.01%	$t_s$	$A_V = +1V/V$ , 2V step		4		$\mu s$
Input Capacitance	$C_{IN}$			3		pF
Input Noise Voltage Density	$V_{NOISE}$	$f = 10kHz$		28		$nV/\sqrt{Hz}$
Input Current Noise Density	$I_{NOISE}$	$f = 10kHz$		0.26		$pA/\sqrt{Hz}$
Crosstalk		$f = 10kHz$ , MAX4332/MAX4333/MAX4334		-124		dB
Capacitive Load Stability		$A_V = 1$ , no sustained oscillations		150		pF
Shutdown Time	$t_{SHDN}$			0.8		$\mu s$
Enable Time from Shutdown	$t_{ENABLE}$			1		$\mu s$
Power-Up Time	$t_{ON}$			5		$\mu s$

## Typical Operating Characteristics

( $V_{CC} = +5V$ ,  $V_{EE} = 0V$ ,  $V_{CM} = V_{CC} / 2$ ,  $V_{SHDN} > 2V$ ,  $T_A = +25^\circ C$ , unless otherwise noted.)

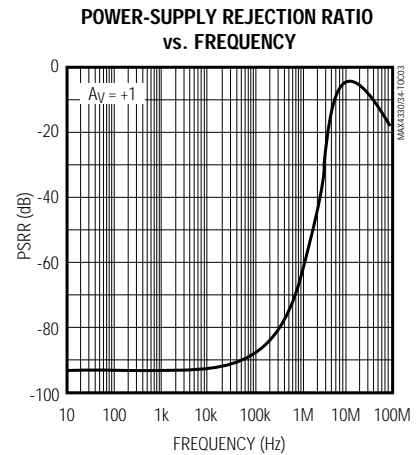
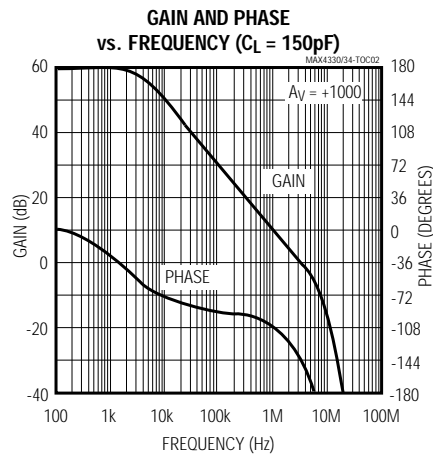
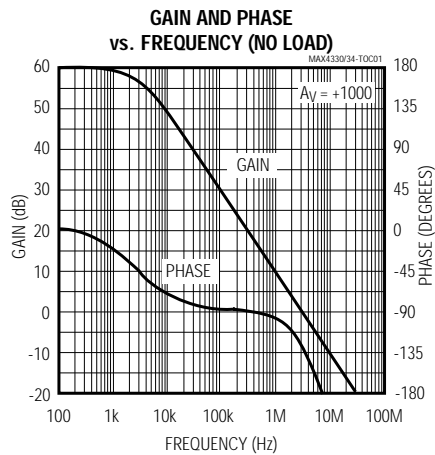

# Single/Dual/Quad, Low-Power, Single-Supply, Rail-to-Rail I/O Op Amps with Shutdown

## Typical Operating Characteristics (continued)

( $V_{CC} = +5V$ ,  $V_{EE} = 0V$ ,  $V_{CM} = V_{CC} / 2$ ,  $V_{SHDN} > 2V$ ,  $T_A = +25^\circ C$ , unless otherwise noted.)

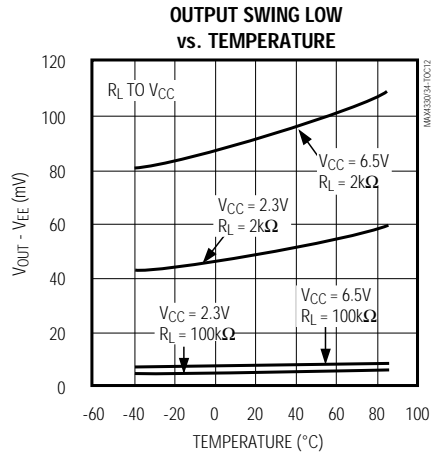
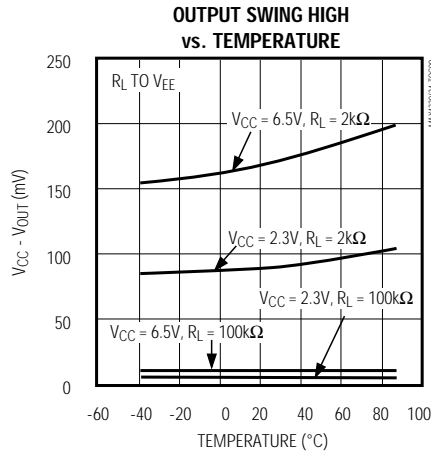
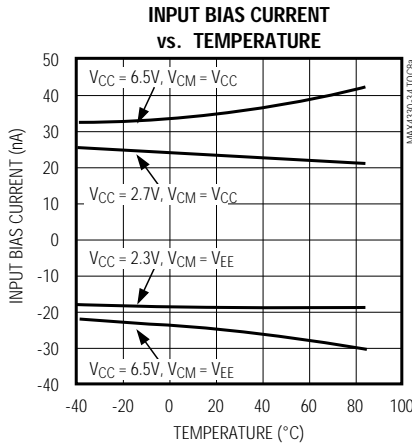
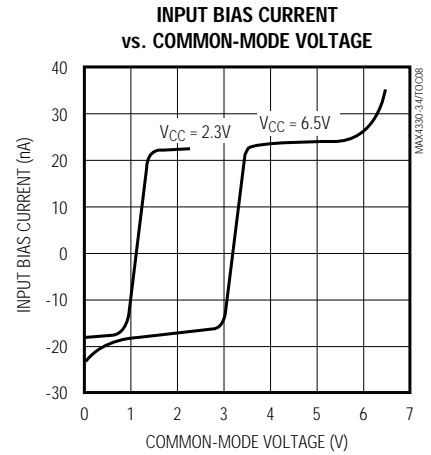
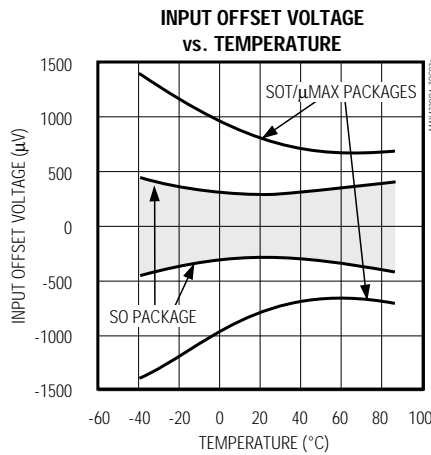
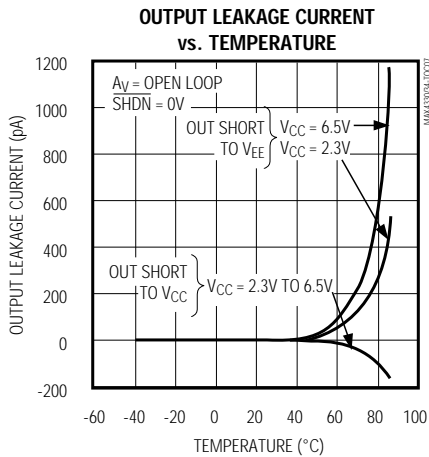
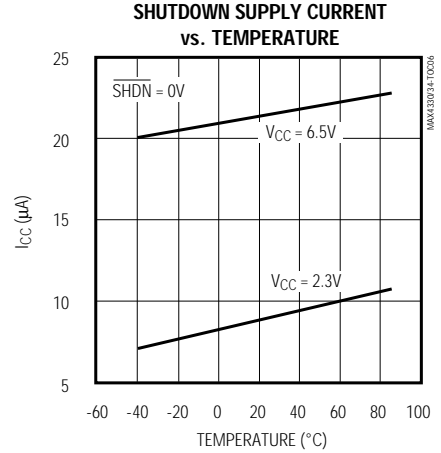
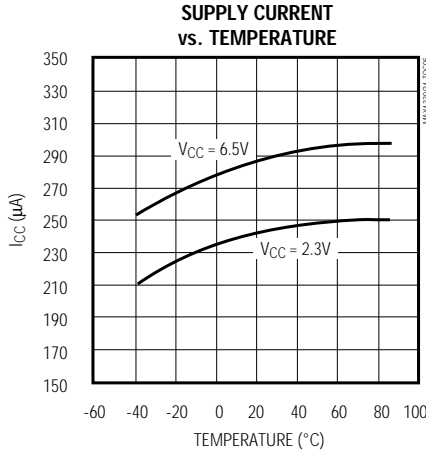
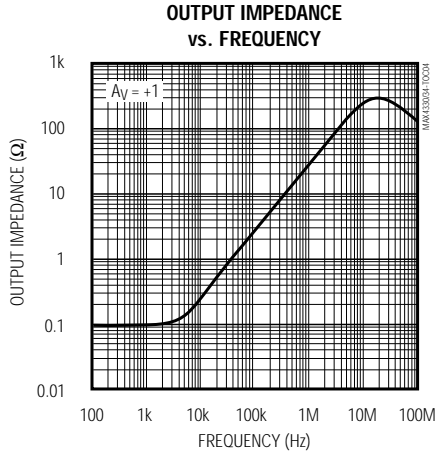

# Single/Dual/Quad, Low-Power, Single-Supply, Rail-to-Rail I/O Op Amps with Shutdown

## Typical Operating Characteristics (continued)

( $V_{CC} = +5V$ ,  $V_{EE} = 0V$ ,  $V_{CM} = V_{CC} / 2$ ,  $V_{SHDN} > 2V$ ,  $T_A = +25^\circ C$ , unless otherwise noted.)

MAX4330-MAX4334

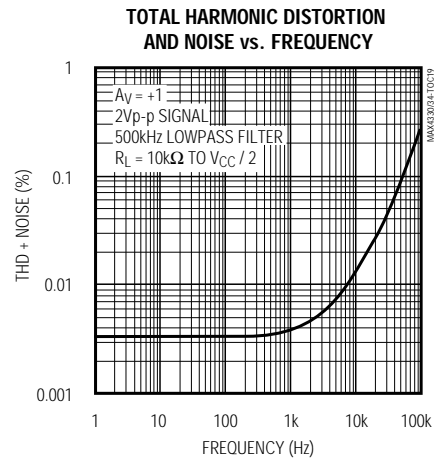
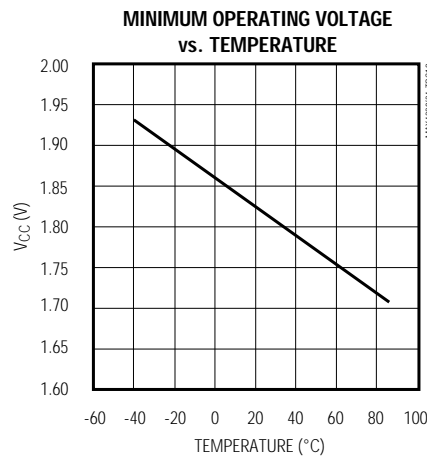
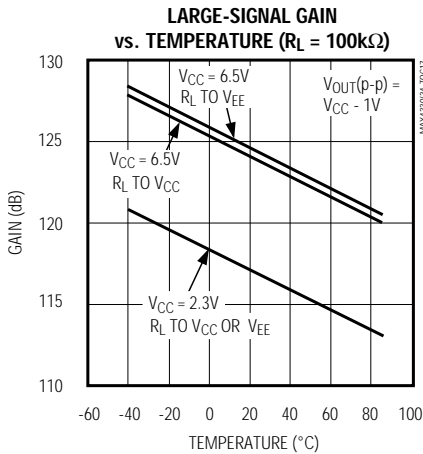
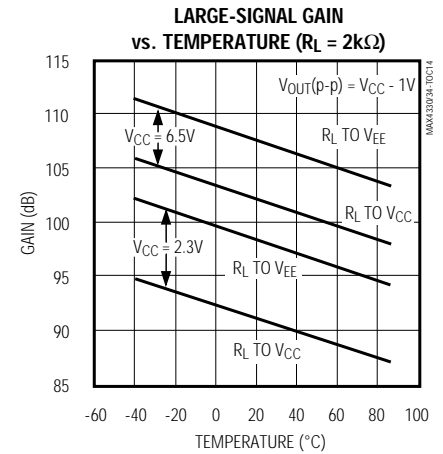
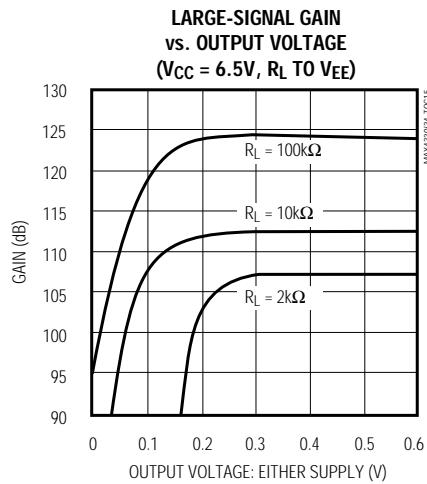
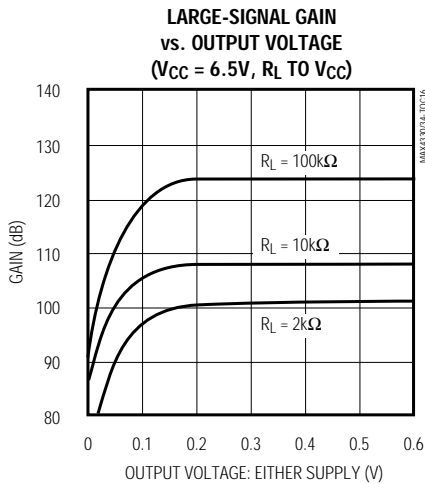
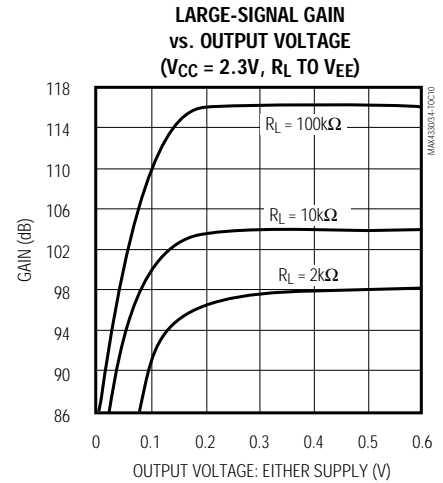
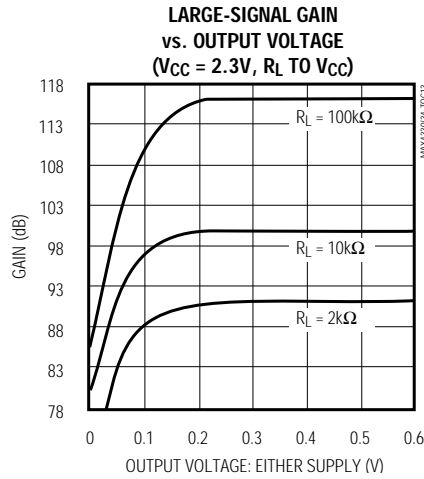
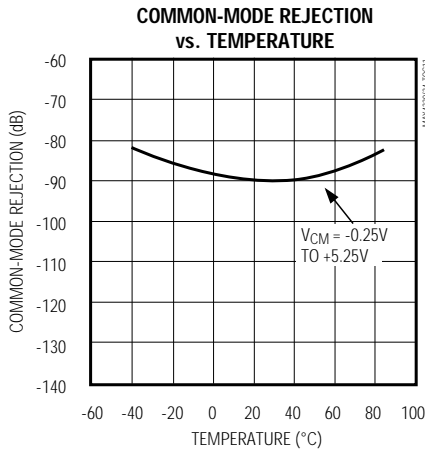

# Single/Dual/Quad, Low-Power, Single-Supply, Rail-to-Rail I/O Op Amps with Shutdown

## Typical Operating Characteristics (continued)

( $V_{CC} = +5V$ ,  $V_{EE} = 0V$ ,  $V_{CM} = V_{CC} / 2$ ,  $V_{SHDN} > 2V$ ,  $T_A = +25^\circ C$ , unless otherwise noted.)

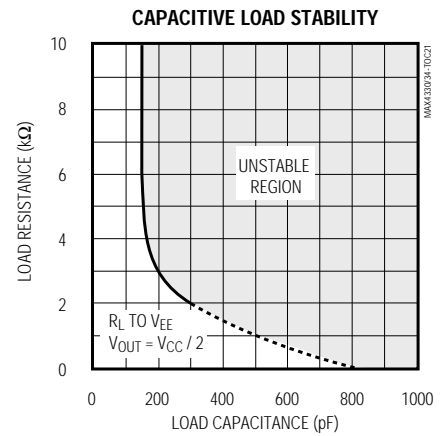
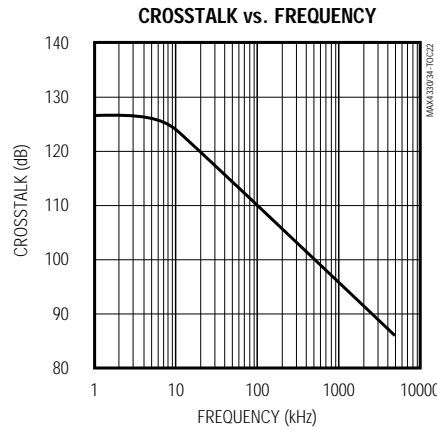
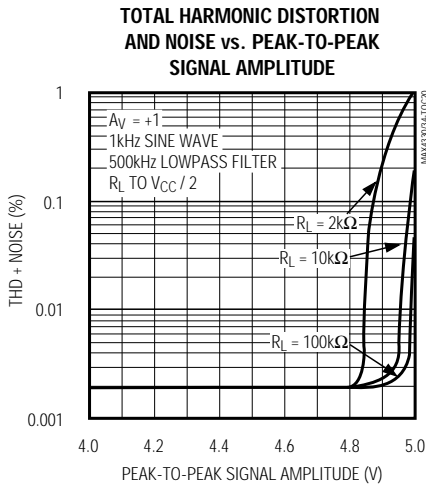

**SMALL-SIGNAL TRANSIENT RESPONSE (NONINVERTING)**

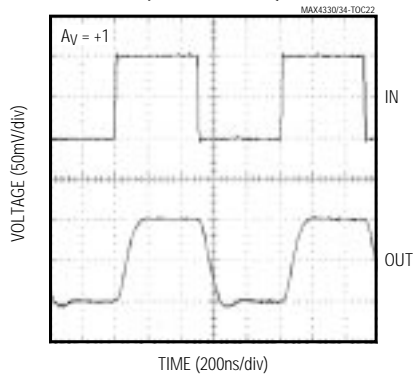

**SMALL-SIGNAL TRANSIENT RESPONSE (INVERTING)**

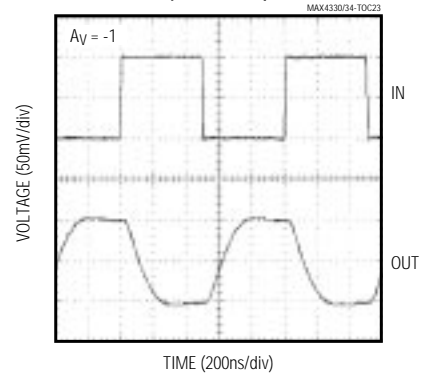

**LARGE-SIGNAL TRANSIENT RESPONSE (NONINVERTING)**

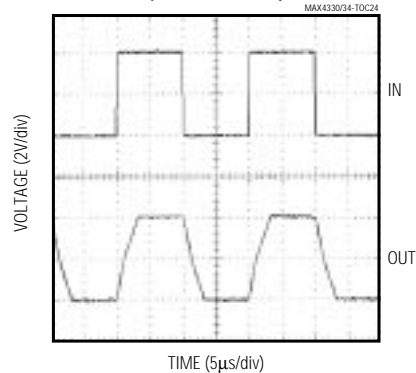

**LARGE-SIGNAL TRANSIENT RESPONSE (INVERTING)**

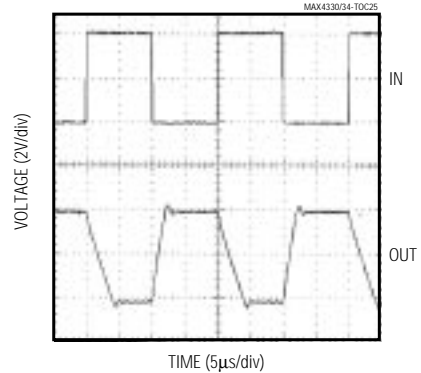

# Single/Dual/Quad, Low-Power, Single-Supply, Rail-to-Rail I/O Op Amps with Shutdown

## Pin Description

MAX4330-MAX4334

PIN						NAME	FUNCTION
MAX4330	MAX4331	MAX4332	MAX4333		MAX4334		
			10-Pin μMAX	14-Pin SO			
1	6	—	—	—	—	OUT	Output
2	4	4	4	4	11	V <sub>EE</sub>	Negative Supply. Ground for single-supply operation.
3	3	—	—	—	—	IN+	Noninverting Input
4	2	—	—	—	—	IN-	Inverting Input
5	7	8	10	14	4	V <sub>CC</sub>	Positive Supply
—	1, 5	—	—	5, 7, 8, 10	—	N.C.	No Connection. Not internally connected.
—	—	1, 7	1, 9	1, 13	1, 7	OUT1, OUT2	Outputs for Amplifiers 1 and 2
—	—	3, 5	3, 7	3, 11	3, 5	IN1+, IN2+	Noninverting Inputs to Amplifiers 1 and 2
—	—	2, 6	2, 8	2, 12	2, 6	IN1-, IN2-	Inverting Inputs to Amplifiers 1 and 2
—	8	—	—	—	—	$\overline{\text{SHDN}}$	Shutdown Input for Amplifier. Drive low for shutdown mode. Drive high or connect to V <sub>CC</sub> for normal operation.
—	—	—	5, 6	6, 9	—	$\overline{\text{SHDN1}}$ , $\overline{\text{SHDN2}}$	Shutdown for Amplifiers 1 and 2. Drive low for shutdown mode. Drive high or connect to V <sub>CC</sub> for normal operation.
—	—	—	—	—	8, 14	OUT3, OUT4	Outputs for Amplifiers 3 and 4
—	—	—	—	—	9, 13	IN3-, IN4-	Inverting Inputs for Amplifiers 3 and 4
—	—	—	—	—	10, 12	IN3+, IN4+	Noninverting Inputs for Amplifiers 3 and 4

# Single/Dual/Quad, Low-Power, Single-Supply, Rail-to-Rail I/O Op Amps with Shutdown

## Detailed Description

### Rail-to-Rail Input Stage

The MAX4330-MAX4334 have rail-to-rail input and output stages that are specifically designed for low-voltage, single-supply operation. The input stage consists of separate NPN and PNP differential stages, which operate together to provide a common-mode range extending to 0.25V beyond both supply rails. The crossover region, which occurs halfway between  $V_{CC}$  and  $V_{EE}$ , is extended to minimize degradation in CMRR caused by mismatched input pairs. The input offset voltage is typically 250 $\mu$ V. Low offset voltage, high bandwidth, rail-to-rail common-mode input range, and rail-to-rail outputs make this family of op amps an excellent choice for precision, low-voltage data-acquisition systems.

Since the input stage consists of NPN and PNP pairs, the input bias current changes polarity as the input voltage passes through the crossover region. Match the effective impedance seen by each input to reduce the offset error due to input bias currents flowing through external source impedances (Figures 1a and 1b). The combination of high source impedance with input capacitance (amplifier input capacitance plus stray capacitance) creates a parasitic pole that produces an underdamped signal response. Reducing input capacitance or placing a small capacitor across the feedback resistor improves response.

The MAX4330-MAX4334's inputs are protected from large differential input voltages by internal 1k $\Omega$  series resistors and back-to-back triple diode stacks across the inputs (Figure 2). For differential input voltages (much less than 1.8V), input resistance is typically 2.3M $\Omega$ . For differential input voltages greater than 1.8V, input resistance is around 2k $\Omega$ , and the input bias current can be approximated by the following equation:

$$I_{BIAS} = (V_{DIFF} - 1.8V) / 2k\Omega$$

In the region where the differential input voltage approaches 1.8V, input resistance decreases exponentially from 2.3M $\Omega$  to 2k $\Omega$  as the diode block begins conducting. Inversely, the bias current increases with the same curve.

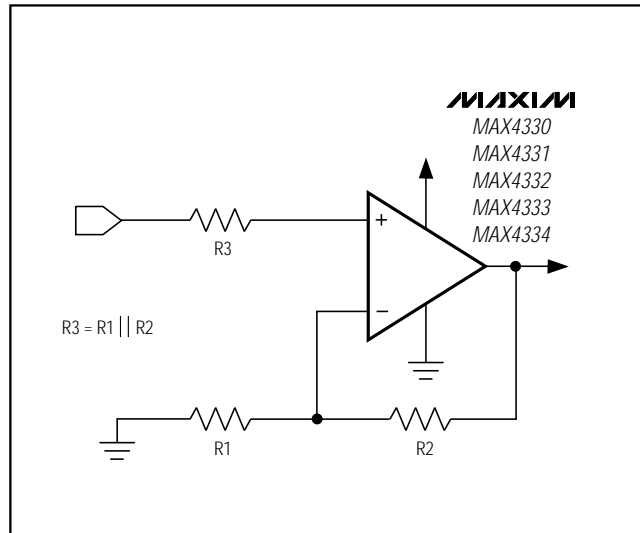

Figure 1a. Reducing Offset Error Due to Bias Current (Noninverting)

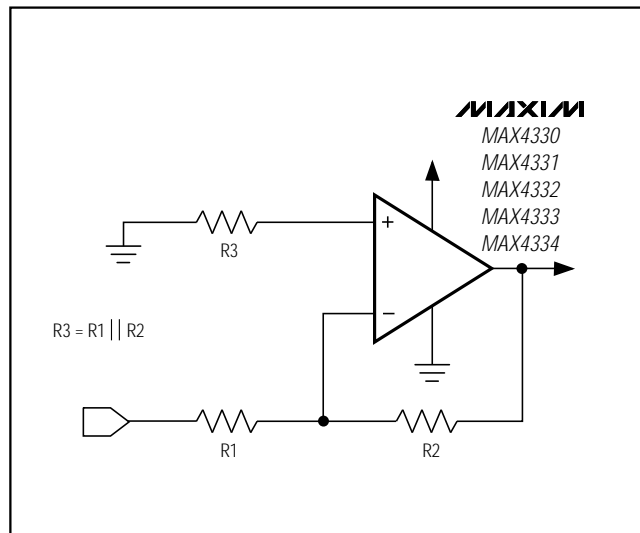

Figure 1b. Reducing Offset Error Due to Bias Current (Inverting)

# Single/Dual/Quad, Low-Power, Single-Supply, Rail-to-Rail I/O Op Amps with Shutdown

MAX4330-MAX4334

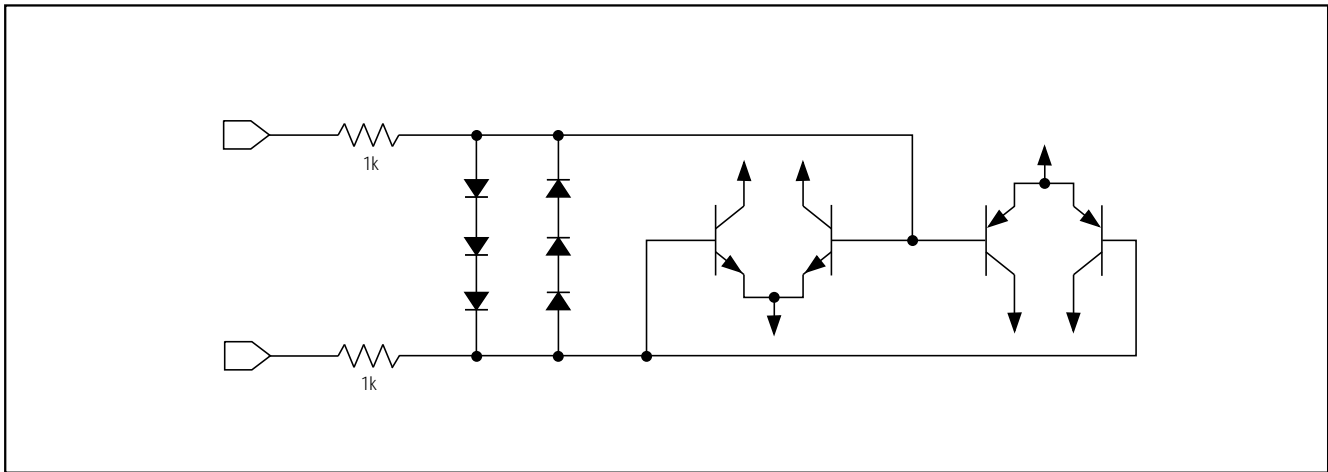

Figure 2. Input Protection Circuit

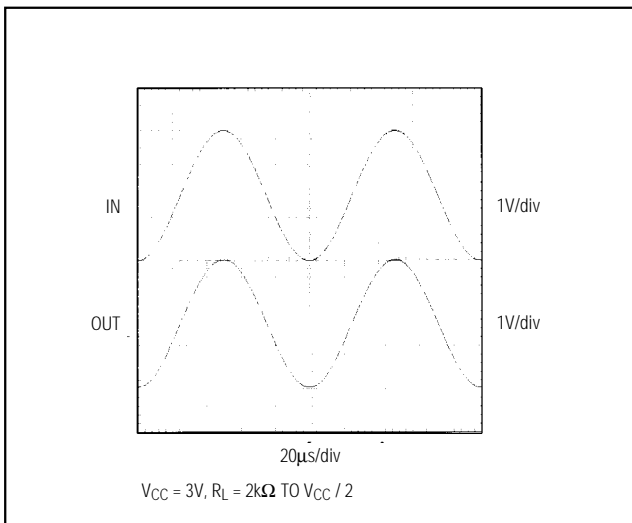

Figure 3. Rail-to-Rail Input/Output Voltage Range

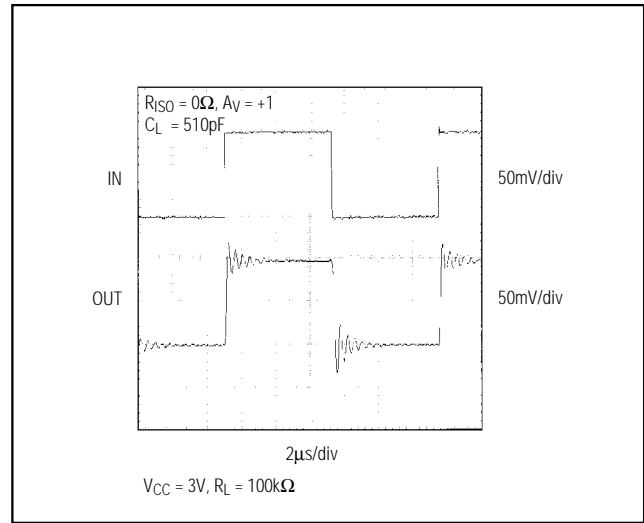

Figure 4. Small-Signal Transient Response with Excessive Capacitive Load

## Rail-to-Rail Output Stage

The MAX4330–MAX4334 output stage can drive up to a  $2\text{k}\Omega$  load and still typically swing within  $125\text{mV}$  of the rails. Figure 3 shows the output voltage swing of a MAX4331 configured as a unity-gain buffer. The operating voltage is a single  $+3\text{V}$  supply, and the input voltage is  $3\text{V}_{\text{p-p}}$ . The output swings to within  $70\text{mV}$  of  $V_{\text{EE}}$  and  $100\text{mV}$  of  $V_{\text{CC}}$ , even with the maximum load applied ( $2\text{k}\Omega$  to mid-supply).

Driving a capacitive load can cause instability in many op amps, especially those with low quiescent current. The MAX4330–MAX4334 are stable for capacitive loads up to  $150\text{pF}$ . The Capacitive Load Stability graph in the *Typical Operating Characteristics* gives the stable operating region for capacitive vs. resistive loads. Figures 4 and 5 show the response of the MAX4331 with an excessive capacitive load, compared with the response when a series resistor is added between the output and the capacitive load. The resistor improves the circuit's response by isolating the load capacitance from the op amp's output (Figure 6).

# Single/Dual/Quad, Low-Power, Single-Supply, Rail-to-Rail I/O Op Amps with Shutdown

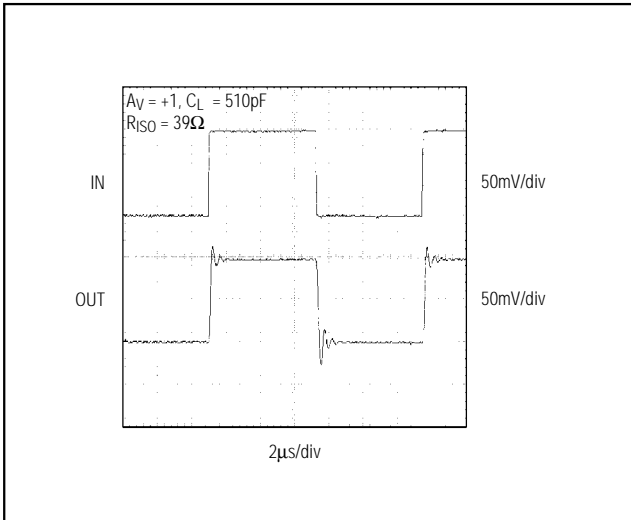

Figure 5. Small-Signal Transient Response with Excessive Capacitive Load and Isolation Resistor

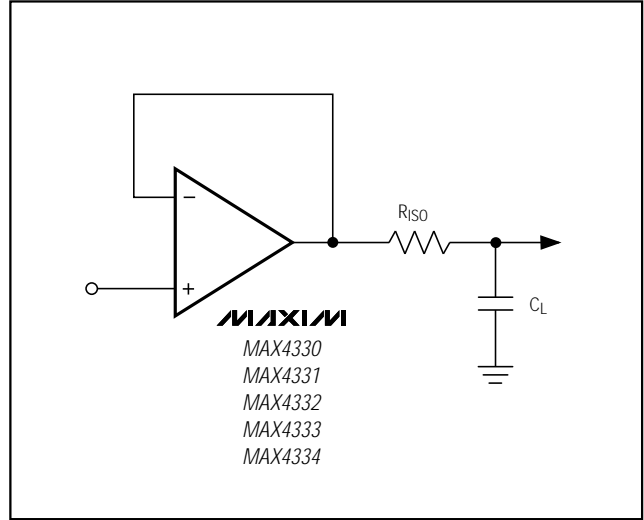

Figure 6. Capacitive-Load-Driving Circuit

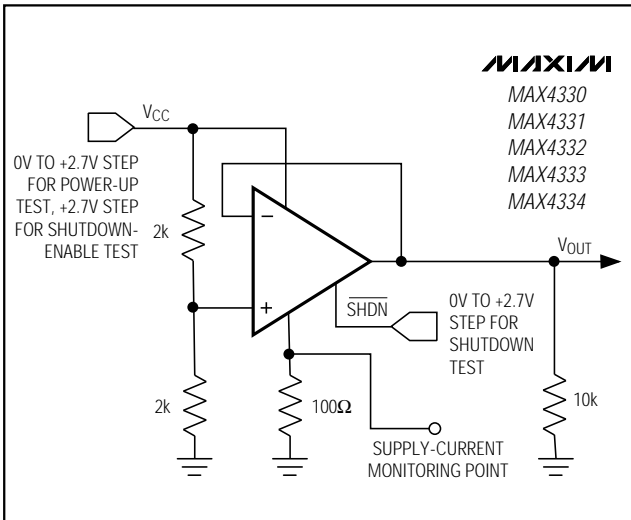

Figure 7. Power-Up/Shutdown Test Circuit

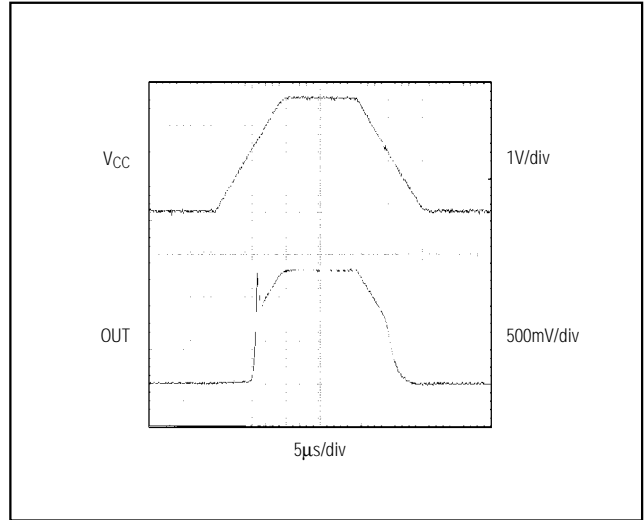

Figure 8. Power-Up/Down Output Voltage

## Applications Information

### Power-Up

The MAX4330-MAX4334 outputs typically settle within 5µs after power-up. Using the test circuit of Figure 7, Figures 8 and 9 show the output voltage and supply current on power-up and power-down.

### Shutdown Mode

The MAX4331/MAX4333 feature a low-power shutdown mode. When the shutdown pin (SHDN) is pulled low, the supply current drops to 9µA per amplifier (typical), the amplifier is disabled, and the outputs enter a high-impedance state. Pulling SHDN high or leaving it floating enables the amplifier. Figures 10 and 11 show the MAX4331/MAX4333's output voltage and supply-current responses to a shutdown pulse.

# Single/Dual/Quad, Low-Power, Single-Supply, Rail-to-Rail I/O Op Amps with Shutdown

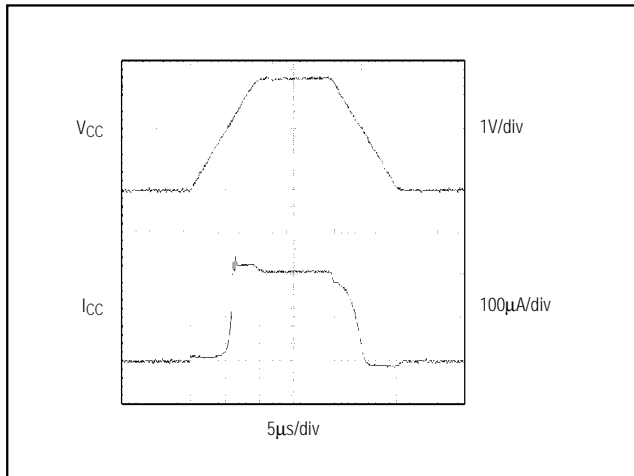

Figure 9. Power-Up/Down Supply Current

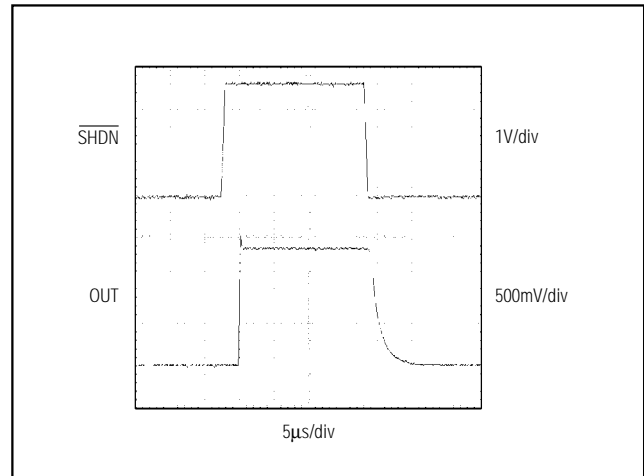

Figure 10. Shutdown Output Voltage Enable/Disable

Do not three-state  $\overline{\text{SHDN}}$ . Due to the output leakage currents of three-state devices and the small internal pull-up current for  $\overline{\text{SHDN}}$ , three-stating this pin could result in indeterminate logic levels, and could adversely affect op-amp operation.

The logic threshold for  $\overline{\text{SHDN}}$  is always referred to  $V_{EE}$ , **not** GND. When using dual supplies, pull  $\overline{\text{SHDN}}$  to  $V_{EE}$  to place the op amp in shutdown mode.

### Power Supplies and Layout

The MAX4330-MAX4334 operate from a single +2.3V to +6.5V power supply, or from dual  $\pm 1.15\text{V}$  to  $\pm 3.25\text{V}$  supplies. For single-supply operation, bypass the power supply with a  $0.1\mu\text{F}$  capacitor to ground ( $V_{EE}$ ). For dual supplies, bypass both  $V_{CC}$  and  $V_{EE}$  with their own set of capacitors to ground.

Good layout technique helps optimize performance by decreasing the amount of stray capacitance at the op amp's inputs and outputs. To decrease stray capacitance, minimize trace lengths by placing external components close to the op amp's pins.

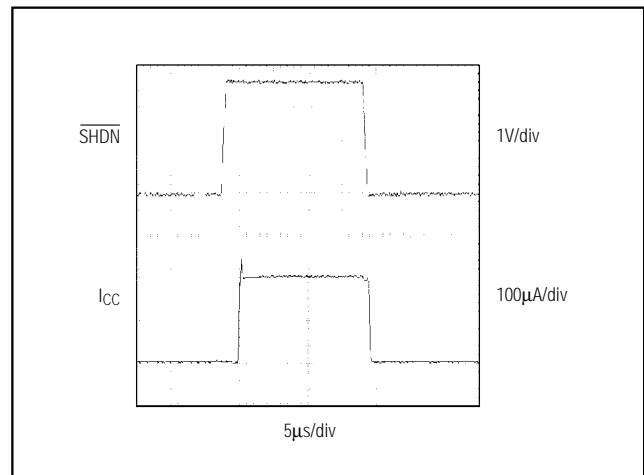
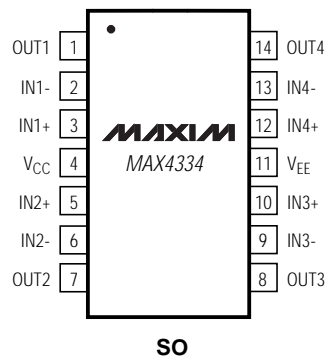
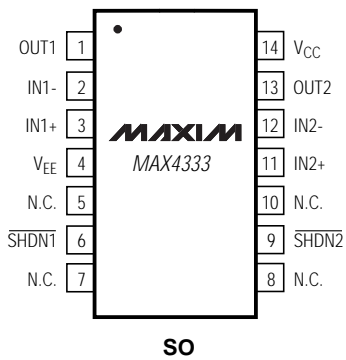
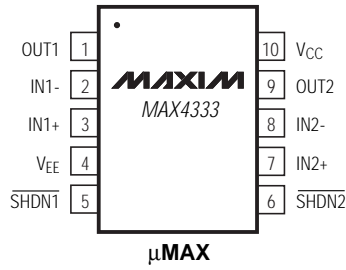
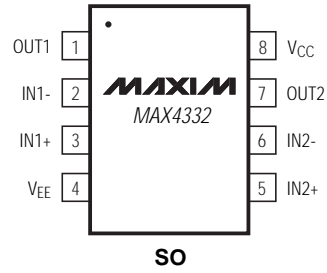
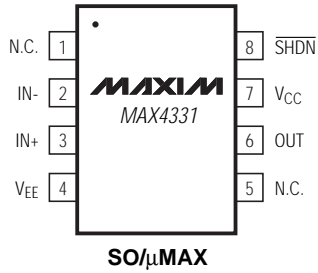

Figure 11. Shutdown Enable/Disable Supply Current

# Single/Dual/Quad, Low-Power, Single-Supply, Rail-to-Rail I/O Op Amps with Shutdown

Pin Configurations (continued)

TOP VIEW



# Single/Dual/Quad, Low-Power, Single-Supply, Rail-to-Rail I/O Op Amps with Shutdown

## Chip Information

### MAX4330/MAX4331

TRANSISTOR COUNT: 199  
SUBSTRATE CONNECTED TO V<sub>EE</sub>

### MAX4332/MAX4333

TRANSISTOR COUNT: 398  
SUBSTRATE CONNECTED TO V<sub>EE</sub>

### MAX4334

TRANSISTOR COUNT: 796  
SUBSTRATE CONNECTED TO V<sub>EE</sub>

MAX4330-MAX4334

## Tape-and-Reel Information

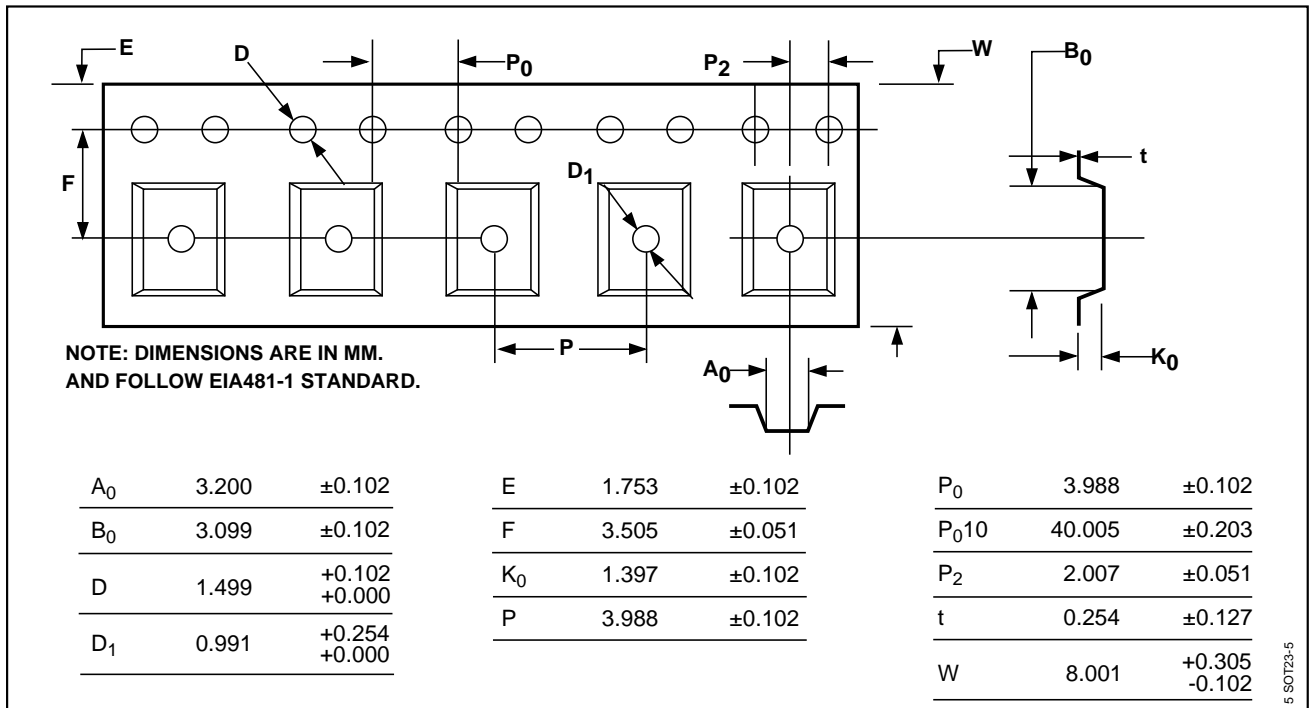

# Single/Dual/Quad, Low-Power, Single-Supply, Rail-to-Rail I/O Op Amps with Shutdown

## Package Information

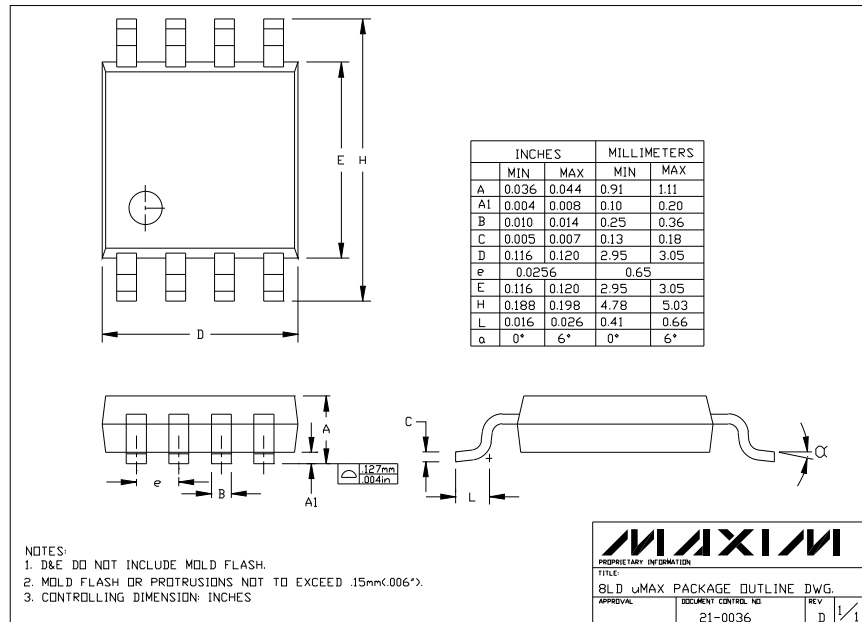
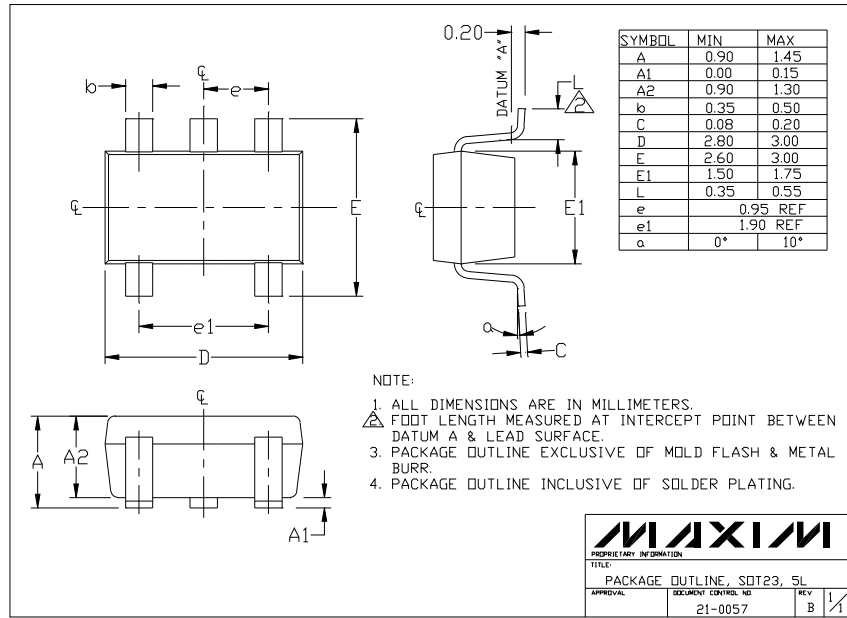

Maxim cannot assume responsibility for use of any circuitry other than circuitry entirely embodied in a Maxim product. No circuit patent licenses are implied. Maxim reserves the right to change the circuitry and specifications without notice at any time.

16 Maxim Integrated Products, 120 San Gabriel Drive, Sunnyvale, CA 94086 408-737-7600

## Looking for pricing, stock, or lifecycle information?

Click below to explore more details on WIN SOURCE:

 [View MAX4330EUK-T on WIN SOURCE](#)

 [Maxim Integrated](#) Information

## Optimize Your Supply Chain with WIN SOURCE Solutions

-  Global Sourcing Solution
-  Obsolete Management
-  Cost Control Management
-  Shortage Management
-  Alternative Solution
-  Excess Inventory Management