



**THE DATASHEET OF  
NR6045T1R3N**



Please read this notice before using the TAIYO YUDEN products.

## REMINDERS

- Product information in this catalog is as of October 2018. All of the contents specified herein are subject to change without notice due to technical improvements, etc. Therefore, please check for the latest information carefully before practical application or use of our products.

Please note that TAIYO YUDEN shall not be in any way responsible for any damages and defects in products or equipment incorporating our products, which are caused under the conditions other than those specified in this catalog or individual product specification sheets.

- Please contact TAIYO YUDEN for further details of product specifications as the individual product specification sheets are available.
- Please conduct validation and verification of our products in actual condition of mounting and operating environment before using our products.
- The products listed in this catalog are intended for use in general electronic equipment (e.g., AV equipment, OA equipment, home electric appliances, office equipment, information and communication equipment including, without limitation, mobile phone, and PC) and medical equipment classified as Class I or II by IMDRF. Please be sure to contact TAIYO YUDEN for further information before using the products for any equipment which may directly cause loss of human life or bodily injury (e.g., transportation equipment including, without limitation, automotive powertrain control system, train control system, and ship control system, traffic signal equipment, disaster prevention equipment, medical equipment classified as Class III by IMDRF, highly public information network equipment including, without limitation, telephone exchange, and base station).

Please do not incorporate our products into any equipment requiring high levels of safety and/or reliability (e.g., aerospace equipment, aviation equipment\*, medical equipment classified as Class IV by IMDRF, nuclear control equipment, undersea equipment, military equipment).

\*Note: There is a possibility that our products can be used only for aviation equipment that does not directly affect the safe operation of aircraft (e.g., in-flight entertainment, cabin light, electric seat, cooking equipment) if such use meets requirements specified separately by TAIYO YUDEN. Please be sure to contact TAIYO YUDEN for further information before using our products for such aviation equipment.

When our products are used even for high safety and/or reliability-required devices or circuits of general electronic equipment, it is strongly recommended to perform a thorough safety evaluation prior to use of our products and to install a protection circuit as necessary.

Please note that unless you obtain prior written consent of TAIYO YUDEN, TAIYO YUDEN shall not be in any way responsible for any damages incurred by you or third parties arising from use of the products listed in this catalog for any equipment requiring inquiry to TAIYO YUDEN or prohibited for use by TAIYO YUDEN as described above.

- Information contained in this catalog is intended to convey examples of typical performances and/or applications of our products and is not intended to make any warranty with respect to the intellectual property rights or any other related rights of TAIYO YUDEN or any third parties nor grant any license under such rights.
- Please note that the scope of warranty for our products is limited to the delivered our products themselves and TAIYO YUDEN shall not be in any way responsible for any damages resulting from a fault or defect in our products. Notwithstanding the foregoing, if there is a written agreement (e.g., supply and purchase agreement, quality assurance agreement) signed by TAIYO YUDEN and your company, TAIYO YUDEN will warrant our products in accordance with such agreement.
- The contents of this catalog are applicable to our products which are purchased from our sales offices or authorized distributors (hereinafter "TAIYO YUDEN's official sales channel"). Please note that the contents of this catalog are not applicable to our products purchased from any seller other than TAIYO YUDEN's official sales channel.
- Caution for Export  
Some of our products listed in this catalog may require specific procedures for export according to "U.S. Export Administration Regulations", "Foreign Exchange and Foreign Trade Control Law" of Japan, and other applicable regulations. Should you have any questions on this matter, please contact our sales staff.

# SMD POWER INDUCTORS(NR SERIES/NR SERIES H TYPE/S TYPE/V TYPE)



REFLOW

■ PARTS NUMBER

\* Operating Temp.: -25~+120°C (NRS40/50/60/80: -25~+125°C) (Including self-generated heat)

N	R	△	4	0	1	8	T	△	1	0	0	M	△
①			②				③		④			⑤	⑥

△=Blank space

## ①Series name

Code	Series name
NR△	Coating resin specification
NRH	
NRS	
NRV	

## ②Dimensions (L × W × H)

Code	Dimensions (L × W × H) [mm]
2010	2.0 × 2.0 × 1.0
2012	2.0 × 2.0 × 1.2
2410	2.4 × 2.4 × 1.0
2412	2.4 × 2.4 × 1.2
3010	3.0 × 3.0 × 1.0
3012	3.0 × 3.0 × 1.2
3015	3.0 × 3.0 × 1.5
4010	4.0 × 4.0 × 1.0
4012	4.0 × 4.0 × 1.2
4018	4.0 × 4.0 × 1.8
5010	4.9 × 4.9 × 1.0
5012	4.9 × 4.9 × 1.2
5014	4.9 × 4.9 × 1.4
5020	4.9 × 4.9 × 2.0
5024	4.9 × 4.9 × 2.4
5030	4.9 × 4.9 × 3.0
5040	4.9 × 4.9 × 4.0
6010	6.0 × 6.0 × 1.0
6012	6.0 × 6.0 × 1.2
6014	6.0 × 6.0 × 1.4
6020	6.0 × 6.0 × 2.0
6028	6.0 × 6.0 × 2.8
6045	6.0 × 6.0 × 4.5
8030	8.0 × 8.0 × 3.0
8040	8.0 × 8.0 × 4.0

## ③Packaging

Code	Packaging
T△	Taping

## ④Nominal inductance

Code (example)	Nominal inductance [μH]
2R2	2.2
100	10
101	100

※R=Decimal point

## ⑤Inductance tolerance

Code	Inductance tolerance
M	±20%
N	±30%

## ⑥Internal code

► This catalog contains the typical specification only due to the limitation of space. When you consider the purchase of our products, please check our product specification sheets. For details of each product (characteristics graph, reliability information, precautions for use, and so on), see our website (<http://www.ty-top.com/>).

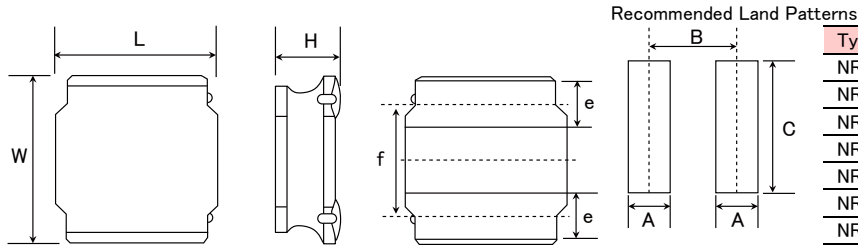

Type	A	B	C
NRV2010	0.65	1.35	2.0
NRS2012, NRV2012			
NRH2410	0.7	1.45	2.0
NRH2412			
NR 3010, NRH3010	0.8	2.2	2.7
NR 3012, NRH3012, NRV3012			
NR 3015, NRS3015			
NR 4010, NRS4010	1.2	2.8	3.7
NR 4012, NRS4012			
NR 4018, NRS4018			
NRS8030	1.8	5.6	7.5
NR 8040, NRS8040			

Unit: mm

Type	L	W	H	e	f	Standard quantity [pcs] Taping
NRV2010	2.0±0.1 (0.079±0.004)	2.0±0.1 (0.079±0.004)	1.0 max (0.039 max)	0.5±0.2 (0.020±0.008)	1.25±0.2 (0.050±0.008)	2500
NRS2012 NRV2012	2.0±0.1 (0.079±0.004)	2.0±0.1 (0.079±0.004)	1.2 max (0.047 max)	0.5±0.2 (0.020±0.008)	1.25±0.2 (0.050±0.008)	2500
NRH2410	2.4±0.1 (0.095±0.004)	2.4±0.1 (0.095±0.004)	1.0 max (0.039 max)	0.6±0.2 (0.024±0.008)	1.45±0.2 (0.057±0.008)	2500
NRH2412	2.4±0.1 (0.095±0.004)	2.4±0.1 (0.095±0.004)	1.2 max (0.047 max)	0.6±0.2 (0.024±0.008)	1.45±0.2 (0.057±0.008)	2500
NR 3010 NRH3010	3.0±0.1 (0.118±0.004)	3.0±0.1 (0.118±0.004)	1.0 max (0.039 max)	0.9±0.2 (0.035±0.008)	1.9±0.2 (0.075±0.008)	2000
NR 3012 NRH3012 NRV3012	3.0±0.1 (0.118±0.004)	3.0±0.1 (0.118±0.004)	1.2 max (0.047 max)	0.9±0.2 (0.035±0.008)	1.9±0.2 (0.075±0.008)	2000
NR 3015 NRS3015	3.0±0.1 (0.118±0.004)	3.0±0.1 (0.118±0.004)	1.5 max (0.059 max)	0.9±0.2 (0.035±0.008)	1.9±0.2 (0.075±0.008)	2000
NR 4010 NRS4010	4.0±0.2 (0.158±0.008)	4.0±0.2 (0.158±0.008)	1.0 max (0.039 max)	1.1±0.2 (0.043±0.008)	2.5±0.2 (0.098±0.008)	5000
NR 4012 NRS4012	4.0±0.2 (0.158±0.008)	4.0±0.2 (0.158±0.008)	1.2 max (0.047 max)	1.1±0.2 (0.043±0.008)	2.5±0.2 (0.098±0.008)	4500
NR 4018 NRS4018	4.0±0.2 (0.158±0.008)	4.0±0.2 (0.158±0.008)	1.8 max (0.071 max)	1.1±0.2 (0.043±0.008)	2.5±0.2 (0.098±0.008)	3500
NRS8030	8.0±0.2 (0.315±0.008)	8.0±0.2 (0.315±0.008)	3.0 max (0.118 max)	1.60±0.3 (0.063±0.012)	5.6±0.3 (0.22±0.012)	1000
NR 8040 NRS8040	8.0±0.2 (0.315±0.008)	8.0±0.2 (0.315±0.008)	*1) 4.2 max (0.165 max) *2) 4.0 max (0.158 max)	1.60±0.3 (0.063±0.012)	5.6±0.3 (0.22±0.012)	1000

\*1) 0R9~6R8 type, \*2) 100~221 type

Unit: mm (inch)

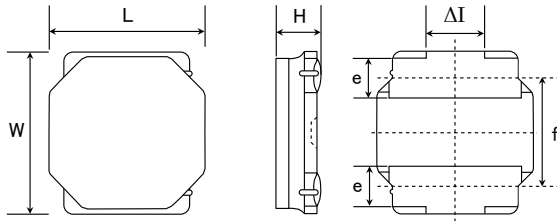

Recommended Land Patterns

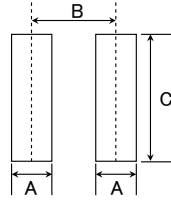

Type	A	B	C
NRS5010	1.5	3.6	4.0
NRS5012			
NRS5014			
NRS5020			
NRS5024			
NRS5030			
NR 5040, NRS5040	1.6	4.7	5.7
NRS6010			
NR 6012, NRS6012			
NRS6014			
NR 6020, NRS6020			
NR 6028, NRS6028			
NR 6045, NRS6045			

Unit: mm

Type	L	W	H	e	f	ΔI	Standard quantity [pcs] Taping
NRS5010	4.9±0.2 (0.193±0.008)	4.9±0.2 (0.193±0.008)	1.0 max (0.039 max)	1.2±0.2 (0.047±0.008)	3.3±0.2 (0.130±0.008)	1.3typ (0.051typ)	1000
NRS5012	4.9±0.2 (0.193±0.008)	4.9±0.2 (0.193±0.008)	1.2 max (0.047 max)	1.2±0.2 (0.047±0.008)	3.3±0.2 (0.130±0.008)	1.3typ (0.051typ)	1000
NRS5014	4.9±0.2 (0.193±0.008)	4.9±0.2 (0.193±0.008)	1.4 max (0.055 max)	1.2±0.2 (0.047±0.008)	3.3±0.2 (0.130±0.008)	1.3typ (0.051typ)	1000
NRS5020	4.9±0.2 (0.193±0.008)	4.9±0.2 (0.193±0.008)	2.0 max (0.079 max)	1.2±0.2 (0.047±0.008)	3.3±0.2 (0.130±0.008)	1.3typ (0.051typ)	800
NRS5024	4.9±0.2 (0.193±0.008)	4.9±0.2 (0.193±0.008)	*3) 2.5 max (0.098 max) *4) 2.4 max (0.095 max)	1.2±0.2 (0.047±0.008)	3.3±0.2 (0.130±0.008)	1.3typ (0.051typ)	2500
NRS5030	4.9±0.2 (0.193±0.008)	4.9±0.2 (0.193±0.008)	*5) 3.1 max (0.122 max) *6) 3.0 max (0.118 max)	1.2±0.2 (0.047±0.008)	3.3±0.2 (0.130±0.008)	1.3typ (0.051typ)	500
NR 5040 NRS5040	4.9±0.2 (0.193±0.008)	4.9±0.2 (0.193±0.008)	*7) 4.1 max (0.161 max) *8) 4.0 max (0.158 max)	1.2±0.2 (0.047±0.008)	3.3±0.2 (0.130±0.008)	1.3typ (0.051typ)	1500
NRS6010	6.0±0.2 (0.236±0.008)	6.0±0.2 (0.236±0.008)	1.0 max (0.039 max)	1.35±0.2 (0.053±0.008)	4.0±0.2 (0.158±0.008)	2.3typ (0.091typ)	1000
NR 6012 NRS6012	6.0±0.2 (0.236±0.008)	6.0±0.2 (0.236±0.008)	1.2 max (0.047 max)	1.35±0.2 (0.053±0.008)	4.0±0.2 (0.158±0.008)	2.3typ (0.091typ)	1000
NRS6014	6.0±0.2 (0.236±0.008)	6.0±0.2 (0.236±0.008)	1.4 max (0.055 max)	1.35±0.2 (0.053±0.008)	4.0±0.2 (0.158±0.008)	2.3typ (0.091typ)	1000
NR 6020 NRS6020	6.0±0.2 (0.236±0.008)	6.0±0.2 (0.236±0.008)	2.0 max (0.079 max)	1.35±0.2 (0.053±0.008)	4.0±0.2 (0.158±0.008)	2.3typ (0.091typ)	2500
NR 6028 NRS6028	6.0±0.2 (0.236±0.008)	6.0±0.2 (0.236±0.008)	2.8 max (0.110 max)	1.35±0.2 (0.053±0.008)	4.0±0.2 (0.158±0.008)	2.3typ (0.091typ)	2000
NR 6045 NRS6045	6.0±0.2 (0.236±0.008)	6.0±0.2 (0.236±0.008)	4.5 max (0.177 max)	1.35±0.2 (0.053±0.008)	4.0±0.2 (0.158±0.008)	2.3typ (0.091typ)	1500

Unit: mm (inch)

- \*3) 1R0~1R5 type, \*4) 2R2~330 type
- \*5) R47~100 type, \*6) 150~470 type
- \*7) 1R5~100 type, \*8) 150~470 type

► This catalog contains the typical specification only due to the limitation of space. When you consider the purchase of our products, please check our product specification sheets. For details of each product (characteristics graph, reliability information, precautions for use, and so on), see our website (<http://www.ty-top.com/>).

■ PARTS NUMBER

● NRS2012 Shielded type

Parts number	EHS	Nominal inductance [ $\mu$ H]	Inductance tolerance	Self-resonant frequency [MHz] (min.)	DC Resistance [ $\Omega$ ] ( $\pm 20\%$ )	Rated current ※) [mA]				Measuring frequency [kHz]
						Saturation current: Idc1		Temperature rise current: Idc2		
						Max.	Typ.	Max.	Typ.	
NRS2012T 1R0N GJ	RoHS	1.0	$\pm 30\%$	—	0.070	1,900	2,050	1,700	1,850	100
NRS2012T 1R5N GJ	RoHS	1.5	$\pm 30\%$	—	0.090	1,650	1,800	1,500	1,650	100
NRS2012T 2R2M GJ	RoHS	2.2	$\pm 20\%$	—	0.107	1,350	1,500	1,370	1,500	100
NRS2012T 3R3M GJ	RoHS	3.3	$\pm 20\%$	—	0.190	1,000	1,150	1,020	1,100	100
NRS2012T 4R7M GJ	RoHS	4.7	$\pm 20\%$	—	0.241	900	1,050	910	1,000	100

● NRV2010 type

Parts number	EHS	Nominal inductance [ $\mu$ H]	Inductance tolerance	Self-resonant frequency [MHz] (min.)	DC Resistance [ $\Omega$ ] ( $\pm 20\%$ )	Rated current ※) [mA]				Measuring frequency [kHz]
						Saturation current: Idc1		Temperature rise current: Idc2		
						Max.	Typ.	Max.	Typ.	
NRV2010T R47N GF	RoHS	0.47	$\pm 30\%$	—	0.052	2,100	2,250	2,000	2,300	100
NRV2010T R68N GF	RoHS	0.68	$\pm 30\%$	—	0.060	1,850	2,000	1,850	2,100	100
NRV2010T 1R0N GF	RoHS	1.0	$\pm 30\%$	—	0.080	1,550	1,700	1,600	1,850	100
NRV2010T 1R5M GF	RoHS	1.5	$\pm 20\%$	—	0.100	1,350	1,450	1,450	1,650	100
NRV2010T 2R2M GF	RoHS	2.2	$\pm 20\%$	—	0.175	1,100	1,200	1,100	1,200	100
NRV2010T 3R3M GF	RoHS	3.3	$\pm 20\%$	—	0.250	880	950	1,000	1,100	100
NRV2010T 4R7M GF	RoHS	4.7	$\pm 20\%$	—	0.320	760	810	820	930	100

● NRV2012 type

Parts number	EHS	Nominal inductance [ $\mu$ H]	Inductance tolerance	Self-resonant frequency [MHz] (min.)	DC Resistance [ $\Omega$ ] ( $\pm 20\%$ )	Rated current ※) [mA]				Measuring frequency [kHz]
						Saturation current: Idc1		Temperature rise current: Idc2		
						Max.	Typ.	Max.	Typ.	
NRV2012T 1R0N GF	RoHS	1.0	$\pm 30\%$	—	0.073	2,200	2,350	1,650	1,830	100
NRV2012T 1R5N GF	RoHS	1.5	$\pm 30\%$	—	0.100	1,800	1,950	1,400	1,550	100
NRV2012T 2R2M GF	RoHS	2.2	$\pm 20\%$	—	0.129	1,600	1,700	1,200	1,350	100
NRV2012T 3R3M GF	RoHS	3.3	$\pm 20\%$	—	0.227	1,250	1,350	900	1,040	100
NRV2012T 4R7M GF	RoHS	4.7	$\pm 20\%$	—	0.325	1,100	1,150	750	850	100

● NRH2410 Shielded type

Parts number	EHS	Nominal inductance [ $\mu$ H]	Inductance tolerance	Self-resonant frequency [MHz] (min.)	DC Resistance [ $\Omega$ ] ( $\pm 20\%$ )	Rated current ※) [mA]				Measuring frequency [kHz]
						Saturation current: Idc1		Temperature rise current: Idc2		
						Max.	Typ.	Max.	Typ.	
NRH2410T R68NN 4	RoHS	0.68	$\pm 30\%$	120	0.060	2,200	2,300	1,570	1,810	100
NRH2410T 1R0NN 4	RoHS	1.0	$\pm 30\%$	106	0.070	1,800	1,950	1,410	1,640	100
NRH2410T 1R5MN	RoHS	1.5	$\pm 20\%$	94	0.110	1,550	1,640	1,160	1,320	100
NRH2410T 2R2MN	RoHS	2.2	$\pm 20\%$	77	0.150	1,290	1,340	970	1,110	100
NRH2410T 3R3MN	RoHS	3.3	$\pm 20\%$	56	0.220	1,000	1,140	770	890	100
NRH2410T 4R7MN	RoHS	4.7	$\pm 20\%$	50	0.290	880	930	670	780	100
NRH2410T 6R8MN	RoHS	6.8	$\pm 20\%$	43	0.410	750	765	570	650	100
NRH2410T 100MN	RoHS	10	$\pm 20\%$	32	0.690	550	605	450	520	100
NRH2410T 150MN	RoHS	15	$\pm 20\%$	27	1.02	470	520	370	430	100
NRH2410T 220MN	RoHS	22	$\pm 20\%$	22	1.47	390	405	300	340	100

● NRH2412 Shielded type

Parts number	EHS	Nominal inductance [ $\mu$ H]	Inductance tolerance	Self-resonant frequency [MHz] (min.)	DC Resistance [ $\Omega$ ] ( $\pm 20\%$ )	Rated current ※) [mA]				Measuring frequency [kHz]
						Saturation current: Idc1		Temperature rise current: Idc2		
						Max.	Typ.	Max.	Typ.	
NRH2412T R47NNGJ	RoHS	0.47	$\pm 30\%$	180	0.050	2,900	3,690	2,100	2,300	100
NRH2412T 1R0NNGH	RoHS	1.0	$\pm 30\%$	101	0.077	2,350	2,610	1,300	1,540	100
NRH2412T 1R5NNGH	RoHS	1.5	$\pm 30\%$	89	0.100	2,100	2,290	1,150	1,390	100
NRH2412T 2R2MNGH	RoHS	2.2	$\pm 20\%$	72	0.140	1,700	1,940	1,000	1,190	100
NRH2412T 3R3MNGH	RoHS	3.3	$\pm 20\%$	56	0.225	1,400	1,600	750	890	100
NRH2412T 4R7MNGH	RoHS	4.7	$\pm 20\%$	45	0.300	1,150	1,280	650	770	100
NRH2412T 6R8MNGH	RoHS	6.8	$\pm 20\%$	34	0.420	950	1,100	550	635	100
NRH2412T 100MNGH	RoHS	10	$\pm 20\%$	29	0.600	810	900	450	510	100

● NRH3010 Shielded type

Parts number	EHS	Nominal inductance [ $\mu$ H]	Inductance tolerance	Self-resonant frequency [MHz] (min.)	DC Resistance [ $\Omega$ ] ( $\pm 20\%$ )	Rated current ※) [mA]				Measuring frequency [kHz]
						Saturation current: Idc1		Temperature rise current: Idc2		
						Max.	Typ.	Max.	Typ.	
NRH3010T 1R2NN	RoHS	1.2	$\pm 30\%$	120	0.065	1,700	1,740	1,480	1,850	100
NRH3010T 1R5NN	RoHS	1.5	$\pm 30\%$	99	0.075	1,440	1,500	1,370	1,680	100
NRH3010T 2R2MN	RoHS	2.2	$\pm 20\%$	86	0.083	1,300	1,400	1,300	1,550	100
NRH3010T 3R3MN	RoHS	3.3	$\pm 20\%$	64	0.130	1,000	1,020	1,030	1,220	100
NRH3010T 4R7MN	RoHS	4.7	$\pm 20\%$	50	0.170	850	930	900	1,090	100
NRH3010T 6R8MN	RoHS	6.8	$\pm 20\%$	44	0.250	700	750	745	920	100
NRH3010T 100MN	RoHS	10	$\pm 20\%$	34	0.350	600	650	620	780	100
NRH3010T 150MN	RoHS	15	$\pm 20\%$	25	0.550	450	520	480	600	100
NRH3010T 220MN	RoHS	22	$\pm 20\%$	22	0.770	380	440	410	510	100
NRH3010T 470MN	RoHS	47	$\pm 20\%$	17	2.050	250	300	285	320	100

※) The saturation current value (Idc1) is the DC current value having inductance decrease down to 30%. (at 20°C)

※) The temperature rise current value (Idc2) is the DC current value having temperature increase up to 40°C. (at 20°C)

※) The rated current is the DC current value that satisfies both of current value saturation current value and temperature rise current value.

■ PARTS NUMBER

● NRH3012 Shielded type

Parts number	EHS	Nominal inductance [μH]	Inductance tolerance	Self-resonant frequency [MHz] (min.)	DC Resistance [Ω] (±20%)	Rated current ※) [mA]				Measuring frequency [kHz]
						Saturation current: Idc1		Temperature rise current: Idc2		
						Max.	Typ.	Max.	Typ.	
NRH3012T R47NN	RoHS	0.47	±30%	160	0.033	2,600	3,200	1,900	2,280	100
NRH3012T 1R0NN	RoHS	1.0	±30%	111	0.048	2,200	2,500	1,710	1,970	100
NRH3012T 1R5NN	RoHS	1.5	±30%	95	0.055	1,700	1,900	1,600	1,750	100
NRH3012T 2R2MN	RoHS	2.2	±20%	78	0.075	1,500	1,750	1,370	1,600	100
NRH3012T 3R3MN	RoHS	3.3	±20%	61	0.100	1,200	1,500	1,210	1,480	100
NRH3012T 4R7MN	RoHS	4.7	±20%	50	0.130	1,000	1,200	1,060	1,280	100
NRH3012T 6R8MN	RoHS	6.8	±20%	43	0.190	850	910	890	1,000	100
NRH3012T 100MN	RoHS	10	±20%	32	0.270	730	780	720	850	100
NRH3012T 150MN	RoHS	15	±20%	26	0.450	530	650	570	680	100
NRH3012T 220MN	RoHS	22	±20%	22	0.630	500	550	500	590	100

● NRV3012 Shielded type

Parts number	EHS	Nominal inductance [μH]	Inductance tolerance	Self-resonant frequency [MHz] (min.)	DC Resistance [Ω] (±20%)	Rated current ※) [mA]				Measuring frequency [kHz]
						Saturation current: Idc1		Temperature rise current: Idc2		
						Max.	Typ.	Max.	Typ.	
NRV3012T 1R0N	RoHS	1.0	±30%	110	0.065	2,500	3,000	1,600	1,970	100
NRV3012T 1R5N	RoHS	1.5	±30%	92	0.075	2,100	2,500	1,400	1,610	100
NRV3012T 2R2M	RoHS	2.2	±20%	70	0.120	1,800	2,100	1,100	1,330	100
NRV3012T 3R3M	RoHS	3.3	±20%	55	0.150	1,600	1,900	1,000	1,260	100
NRV3012T 4R7M	RoHS	4.7	±20%	48	0.190	1,250	1,500	850	1,040	100
NRV3012T 6R8M	RoHS	6.8	±20%	40	0.300	950	1,200	650	800	100
NRV3012T 100M	RoHS	10	±20%	32	0.470	800	990	550	640	100

● NRS3015 Shielded type

Parts number	EHS	Nominal inductance [μH]	Inductance tolerance	Self-resonant frequency [MHz] (min.)	DC Resistance [Ω] (±20%)	Rated current ※) [mA]				Measuring frequency [kHz]
						Saturation current: Idc1		Temperature rise current: Idc2		
						Max.	Typ.	Max.	Typ.	
NRS3015T 1R0NNGH	RoHS	1.0	±30%	100	0.030	2,100	2,400	2,100	2,350	100
NRS3015T 1R5NNGH	RoHS	1.5	±30%	87	0.038	1,800	2,100	1,820	2,100	100
NRS3015T 2R2MNGH	RoHS	2.2	±20%	64	0.058	1,480	1,700	1,500	1,800	100
NRS3015T 3R3MNGH	RoHS	3.3	±20%	49	0.078	1,210	1,400	1,230	1,500	100
NRS3015T 4R7MNGH	RoHS	4.7	±20%	40	0.120	1,020	1,100	1,040	1,300	100
NRS3015T 6R8MNGH	RoHS	6.8	±20%	36	0.160	870	920	880	1,100	100
NRS3015T 100MNGH	RoHS	10	±20%	28	0.220	700	750	710	840	100
NRS3015T 150MNGH	RoHS	15	±20%	23	0.325	580	680	680	760	100
NRS3015T 220MNGH	RoHS	22	±20%	20	0.520	470	540	470	530	100
NRS3015T 330MNGH	RoHS	33	±20%	18	0.780	400	440	440	490	100
NRS3015T 470MNGH	RoHS	47	±20%	17	1.100	325	380	350	380	100

● NRS4010 Shielded type

Parts number	EHS	Nominal inductance [μH]	Inductance tolerance	Self-resonant frequency [MHz] (min.)	DC Resistance [Ω] (±20%)	Rated current ※) [mA]				Measuring frequency [kHz]
						Saturation current: Idc1		Temperature rise current: Idc2		
						Max.	Typ.	Max.	Typ.	
NRS4010T 1R0NDGG	RoHS	1.0	±30%	116	0.056	2,000	2,280	1,900	2,390	100
NRS4010T 2R2MDGG	RoHS	2.2	±20%	73	0.085	1,200	1,610	1,500	1,800	100
NRS4010T 3R3MDGG	RoHS	3.3	±20%	58	0.100	1,100	1,300	1,400	1,700	100
NRS4010T 4R7MDGG	RoHS	4.7	±20%	47	0.140	950	1,100	1,200	1,450	100
NRS4010T 6R8MDGG	RoHS	6.8	±20%	38	0.200	800	890	1,000	1,200	100
NRS4010T 100MDGG	RoHS	10	±20%	31	0.300	620	760	750	860	100
NRS4010T 150MDGG	RoHS	15	±20%	24	0.430	540	635	600	700	100
NRS4010T 220MDGG	RoHS	22	±20%	19	0.570	450	540	500	600	100
NRS4010T 330MDGG	RoHS	33	±20%	15	0.900	350	440	400	460	100
NRS4010T 470MDGG	RoHS	47	±20%	13	1.250	300	350	350	370	100

● NRS4012 Shielded type

Parts number	EHS	Nominal inductance [μH]	Inductance tolerance	Self-resonant frequency [MHz] (min.)	DC Resistance [Ω] (±20%)	Rated current ※) [mA]				Measuring frequency [kHz]
						Saturation current: Idc1		Temperature rise current: Idc2		
						Max.	Typ.	Max.	Typ.	
NRS4012T 1R0NDGG	RoHS	1.0	±30%	100	0.042	2,800	2,900	2,200	2,670	100
NRS4012T 1R5NDGG	RoHS	1.5	±30%	90	0.051	2,300	2,500	2,000	2,430	100
NRS4012T 2R2MDGJ	RoHS	2.2	±20%	70	0.060	1,650	1,950	1,900	2,100	100
NRS4012T 3R3MDGJ	RoHS	3.3	±20%	60	0.070	1,400	1,700	1,700	1,880	100
NRS4012T 4R7MDGJ	RoHS	4.7	±20%	45	0.095	1,200	1,320	1,500	1,570	100
NRS4012T 6R8MDGJ	RoHS	6.8	±20%	35	0.125	900	1,170	1,300	1,400	100
NRS4012T 100MDGJ	RoHS	10	±20%	30	0.170	800	990	1,100	1,200	100
NRS4012T 150MDGJ	RoHS	15	±20%	24	0.260	650	820	750	840	100
NRS4012T 220MDGJ	RoHS	22	±20%	18	0.400	500	620	620	650	100
NRS4012T 330MDGJ	RoHS	33	±20%	15	0.600	400	500	480	530	100
NRS4012T 470MDGJ	RoHS	47	±20%	12	0.770	350	430	420	470	100

※) The saturation current value (Idc1) is the DC current value having inductance decrease down to 30%. (at 20°C)

※) The temperature rise current value (Idc2) is the DC current value having temperature increase up to 40°C. (at 20°C)

※) The rated current is the DC current value that satisfies both of current value saturation current value and temperature rise current value.

■ PARTS NUMBER

● NRS4018 Shielded type

Parts number	EHS	Nominal inductance [ $\mu$ H]	Inductance tolerance	Self-resonant frequency [MHz] (min.)	DC Resistance [ $\Omega$ ] ( $\pm 20\%$ )	Rated current ※) [mA]				Measuring frequency [kHz]
						Saturation current: Idc1		Temperature rise current: Idc2		
						Max.	Typ.	Max.	Typ.	
NRS4018T 1R0NDGJ	RoHS	1.0	$\pm 30\%$	90	0.027	4,000	4,590	3,200	3,720	100
NRS4018T 1R5NDGJ	RoHS	1.5	$\pm 30\%$	75	0.037	3,300	3,750	2,400	3,000	100
NRS4018T 2R2MDGJ	RoHS	2.2	$\pm 20\%$	60	0.042	3,000	3,110	2,200	2,590	100
NRS4018T 3R3MDGJ	RoHS	3.3	$\pm 20\%$	45	0.055	2,300	2,560	2,000	2,240	100
NRS4018T 4R7MDGJ	RoHS	4.7	$\pm 20\%$	35	0.070	2,000	2,330	1,700	1,880	100
NRS4018T 6R8MDGJ	RoHS	6.8	$\pm 20\%$	30	0.098	1,600	1,820	1,450	1,690	100
NRS4018T 100MDGJ	RoHS	10	$\pm 20\%$	25	0.150	1,300	1,440	1,200	1,250	100
NRS4018T 150MDGJ	RoHS	15	$\pm 20\%$	18	0.210	1,100	1,150	850	915	100
NRS4018T 220MDGJ	RoHS	22	$\pm 20\%$	15	0.290	900	920	720	810	100
NRS4018T 330MDGJ	RoHS	33	$\pm 20\%$	12	0.460	700	830	550	630	100
NRS4018T 470MDGJ	RoHS	47	$\pm 20\%$	10	0.650	600	700	440	520	100
NRS4018T 680MDGJ	RoHS	68	$\pm 20\%$	8.3	1.00	520	600	320	400	100
NRS4018T 101MDGJ	RoHS	100	$\pm 20\%$	6.5	1.45	420	490	280	330	100
NRS4018T 151MDGJ	RoHS	150	$\pm 20\%$	5.5	2.30	340	390	220	280	100
NRS4018T 221MDGJ	RoHS	220	$\pm 20\%$	4.0	3.80	275	310	170	210	100

● NRS5010 type

Parts number	EHS	Nominal inductance [ $\mu$ H]	Inductance tolerance	Self-resonant frequency [MHz] (min.)	DC Resistance [ $\Omega$ ] ( $\pm 20\%$ )	Rated current ※) [mA]				Measuring frequency [kHz]
						Saturation current: Idc1		Temperature rise current: Idc2		
						Max.	Typ.	Max.	Typ.	
NRS5010T 1R0NMGF	RoHS	1.0	$\pm 30\%$	95	0.070	2,350	2,510	1,750	2,000	100
NRS5010T 2R2NMGF	RoHS	2.2	$\pm 30\%$	65	0.105	1,500	1,710	1,400	1,600	100
NRS5010T 3R3MMGF	RoHS	3.3	$\pm 20\%$	42	0.125	1,400	1,530	1,250	1,520	100
NRS5010T 4R7MMGF	RoHS	4.7	$\pm 20\%$	37	0.145	1,200	1,340	1,150	1,390	100
NRS5010T 6R8MMGF	RoHS	6.8	$\pm 20\%$	33	0.185	1,000	1,120	1,000	1,210	100
NRS5010T 100MMGF	RoHS	10	$\pm 20\%$	23	0.250	850	970	900	950	100
NRS5010T 150MMGF	RoHS	15	$\pm 20\%$	19	0.400	680	740	650	700	100
NRS5010T 220MMGF	RoHS	22	$\pm 20\%$	15	0.600	550	620	450	560	100

● NRS5012 type

Parts number	EHS	Nominal inductance [ $\mu$ H]	Inductance tolerance	Self-resonant frequency [MHz] (min.)	DC Resistance [ $\Omega$ ] ( $\pm 20\%$ )	Rated current ※) [mA]				Measuring frequency [kHz]
						Saturation current: Idc1		Temperature rise current: Idc2		
						Max.	Typ.	Max.	Typ.	
NRS5012T 1R0NMGF	RoHS	1.0	$\pm 30\%$	100	0.053	4,500	4,670	2,300	2,750	100
NRS5012T 1R5NMGF	RoHS	1.5	$\pm 30\%$	86	0.070	3,800	3,970	2,200	2,470	100
NRS5012T 2R2MMGF	RoHS	2.2	$\pm 20\%$	70	0.085	3,100	3,510	2,000	2,300	100
NRS5012T 3R3MMGF	RoHS	3.3	$\pm 20\%$	48	0.160	2,400	2,580	1,450	1,650	100
NRS5012T 4R7MMGF	RoHS	4.7	$\pm 20\%$	40	0.180	2,200	2,320	1,400	1,560	100
NRS5012T 6R8MMGF	RoHS	6.8	$\pm 20\%$	36	0.260	1,700	1,950	1,100	1,260	100
NRS5012T 100MMGF	RoHS	10	$\pm 20\%$	26	0.420	1,400	1,550	850	1,000	100
NRS5012T 150MMGF	RoHS	15	$\pm 20\%$	22	0.670	1,200	1,240	640	740	100

● NRS5014 Shielded type

Parts number	EHS	Nominal inductance [ $\mu$ H]	Inductance tolerance	Self-resonant frequency [MHz] (min.)	DC Resistance [ $\Omega$ ] ( $\pm 20\%$ )	Rated current ※) [mA]				Measuring frequency [kHz]
						Saturation current: Idc1		Temperature rise current: Idc2		
						Max.	Typ.	Max.	Typ.	
NRS5014T R47NMGG	RoHS	0.47	$\pm 30\%$	185	0.025	5,800	6,400	3,300	3,470	100
NRS5014T 1R2NMGG	RoHS	1.2	$\pm 30\%$	86	0.045	3,800	4,200	2,400	3,000	100
NRS5014T 2R2NMGG	RoHS	2.2	$\pm 30\%$	56	0.065	2,800	3,100	2,000	2,400	100
NRS5014T 3R3NMGG	RoHS	3.3	$\pm 30\%$	48	0.080	2,350	2,650	1,700	2,200	100
NRS5014T 4R7NMGG	RoHS	4.7	$\pm 30\%$	41	0.100	2,050	2,400	1,400	1,900	100
NRS5014T 6R8MMGG	RoHS	6.8	$\pm 20\%$	33	0.150	1,600	1,850	1,200	1,450	100
NRS5014T 100MMGG	RoHS	10	$\pm 20\%$	27	0.200	1,400	1,600	1,050	1,250	100
NRS5014T 150MMGG	RoHS	15	$\pm 20\%$	20	0.320	1,100	1,300	650	790	100
NRS5014T 220MMGG	RoHS	22	$\pm 20\%$	16	0.450	900	1,000	550	660	100

● NRS5020 Shielded type

Parts number	EHS	Nominal inductance [ $\mu$ H]	Inductance tolerance	Self-resonant frequency [MHz] (min.)	DC Resistance [ $\Omega$ ] ( $\pm 20\%$ )	Rated current ※) [mA]				Measuring frequency [kHz]
						Saturation current: Idc1		Temperature rise current: Idc2		
						Max.	Typ.	Max.	Typ.	
NRS5020T R47NMGG	RoHS	0.47	$\pm 30\%$	230	0.012	6,100	6,900	5,000	5,800	100
NRS5020T 1R0NMGG	RoHS	1.0	$\pm 30\%$	81	0.021	4,000	4,500	3,600	3,710	100
NRS5020T 1R5NMGG	RoHS	1.5	$\pm 30\%$	68	0.026	3,350	3,800	3,200	3,540	100
NRS5020T 2R2NMGG	RoHS	2.2	$\pm 30\%$	57	0.035	2,900	3,200	2,900	3,200	100
NRS5020T 3R3NMGG	RoHS	3.3	$\pm 30\%$	46	0.048	2,400	2,700	2,400	3,080	100
NRS5020T 4R7NMGG	RoHS	4.7	$\pm 20\%$	37	0.060	2,000	2,270	2,000	2,370	100
NRS5020T 6R8MMGG	RoHS	6.8	$\pm 20\%$	30	0.090	1,600	1,850	1,650	2,200	100
NRS5020T 100MMGG	RoHS	10	$\pm 20\%$	24	0.120	1,300	1,480	1,450	1,850	100
NRS5020T 150MMGG	RoHS	15	$\pm 20\%$	20	0.165	1,100	1,260	1,200	1,480	100
NRS5020T 220MMGG	RoHS	22	$\pm 20\%$	17	0.260	900	1,100	1,000	1,230	100
NRS5020T 470MMGG	RoHS	47	$\pm 20\%$	12	0.435	630	750	560	610	100
NRS5020T 101MMGG	RoHS	100	$\pm 20\%$	7	0.850	420	510	400	450	100

※) The saturation current value (Idc1) is the DC current value having inductance decrease down to 30%. (at 20°C)

※) The temperature rise current value (Idc2) is the DC current value having temperature increase up to 40°C. (at 20°C)

※) The rated current is the DC current value that satisfies both of current value saturation current value and temperature rise current value.

■ PARTS NUMBER

● NRS5024 Shielded type

Parts number	EHS	Nominal inductance [μH]	Inductance tolerance	Self-resonant frequency [MHz] (min.)	DC Resistance [Ω] (±20%)	Rated current ※) [mA]				Measuring frequency [kHz]
						Saturation current: Idc1		Temperature rise current: Idc2		
						Max.	Typ.	Max.	Typ.	
NRS5024T 1R0NMGJ	RoHS	1.0	±30%	85	0.016	5,800	6,800	4,400	4,900	100
NRS5024T 1R5NMGJ	RoHS	1.5	±30%	67	0.022	5,200	5,800	3,600	4,300	100
NRS5024T 2R2NMGJ	RoHS	2.2	±30%	51	0.029	4,100	4,800	3,100	3,600	100
NRS5024T 3R3NMGJ	RoHS	3.3	±30%	41	0.043	3,100	3,700	2,400	2,750	100
NRS5024T 4R7MMGJ	RoHS	4.7	±20%	37	0.055	2,700	3,400	2,000	2,400	100
NRS5024T 6R8MMGJ	RoHS	6.8	±20%	28	0.080	2,200	2,750	1,600	1,800	100
NRS5024T 100MMGJ	RoHS	10	±20%	21	0.125	1,700	2,100	1,200	1,460	100
NRS5024T 150MMGJ	RoHS	15	±20%	18	0.170	1,400	1,750	1,000	1,250	100
NRS5024T 220MMGJ	RoHS	22	±20%	15	0.230	1,200	1,450	820	900	100
NRS5024T 330MMGJ	RoHS	33	±20%	11	0.370	1,000	1,200	630	700	100

● NRS5030 Shielded type

Parts number	EHS	Nominal inductance [μH]	Inductance tolerance	Self-resonant frequency [MHz] (min.)	DC Resistance [Ω] (±30%)	Rated current ※) [mA]				Measuring frequency [kHz]
						Saturation current: Idc1		Temperature rise current: Idc2		
						Max.	Typ.	Max.	Typ.	
NRS5030T R47NMGJ	RoHS	0.47	±30%	185	0.010	9,000	9,400	5,000	5,900	100
NRS5030T 1R0NMGJ	RoHS	1.0	±30%	110	0.015	6,600	7,400	4,000	4,900	100
NRS5030T 2R2NMGJ	RoHS	2.2	±30%	46	0.023	4,200	5,000	3,500	4,100	100
NRS5030T 3R3MMGJ	RoHS	3.3	±20%	36	0.030	3,600	3,900	3,000	3,600	100
NRS5030T 4R7MMGJ	RoHS	4.7	±20%	31	0.035	3,100	3,500	2,600	3,000	100
NRS5030T 6R8MMGJ	RoHS	6.8	±20%	22	0.052	2,500	2,800	2,300	2,500	100
NRS5030T 100MMGJ	RoHS	10	±20%	20	0.070	2,100	2,300	1,700	2,000	100
NRS5030T 150MMGJ	RoHS	15	±20%	14	0.125	1,600	1,800	1,400	1,550	100
NRS5030T 220MMGJ	RoHS	22	±20%	13	0.180	1,400	1,500	1,050	1,200	100
NRS5030T 330MMGJ	RoHS	33	±20%	10	0.225	1,150	1,250	800	950	100
NRS5030T 470MMGJ	RoHS	47	±20%	9	0.325	950	1,050	700	800	100

● NRS5040 Shielded type

Parts number	EHS	Nominal inductance [μH]	Inductance tolerance	Self-resonant frequency [MHz] (min.)	DC Resistance [Ω] (±30%)	Rated current ※) [mA]				Measuring frequency [kHz]
						Saturation current: Idc1		Temperature rise current: Idc2		
						Max.	Typ.	Max.	Typ.	
NRS5040T 1R5NMGJ	RoHS	1.5	±30%	60	0.017	6,400	6,530	4,500	4,730	100
NRS5040T 2R2NMGJ	RoHS	2.2	±30%	42	0.022	5,000	5,250	3,700	4,080	100
NRS5040T 3R3NMGJ	RoHS	3.3	±30%	32	0.027	4,000	4,280	3,300	3,770	100
NRS5040T 4R7NMGK	RoHS	4.7	±30%	28	0.029	3,300	3,470	3,100	3,500	100
NRS5040T 6R8MMGJ	RoHS	6.8	±20%	21	0.049	2,800	2,910	2,400	2,470	100
NRS5040T 100MMGJ	RoHS	10	±20%	18	0.056	2,300	2,470	2,100	2,210	100
NRS5040T 150MMGJ	RoHS	15	±20%	13	0.080	2,000	2,150	1,800	1,920	100
NRS5040T 220MMGK	RoHS	22	±20%	9	0.126	1,500	1,580	1,400	1,470	100
NRS5040T 330MMGJ	RoHS	33	±20%	7	0.180	1,300	1,390	1,200	1,270	100
NRS5040T 470MMGJ	RoHS	47	±20%	6	0.310	1,100	1,150	900	950	100

● NRS6010 type

Parts number	EHS	Nominal inductance [μH]	Inductance tolerance	Self-resonant frequency [MHz] (min.)	DC Resistance [Ω] (±20%)	Rated current ※) [mA]				Measuring frequency [kHz]
						Saturation current: Idc1		Temperature rise current: Idc2		
						Max.	Typ.	Max.	Typ.	
NRS6010T 1R5MMGF	RoHS	1.5	±20%	77	0.090	2,400	2,650	1,900	2,150	100
NRS6010T 2R2MMGF	RoHS	2.2	±20%	56	0.110	1,900	2,120	1,700	1,950	100
NRS6010T 3R3MMGF	RoHS	3.3	±20%	42	0.135	1,600	1,750	1,500	1,750	100
NRS6010T 4R7MMGF	RoHS	4.7	±20%	36	0.165	1,300	1,470	1,400	1,600	100
NRS6010T 6R8MMGF	RoHS	6.8	±20%	30	0.220	1,200	1,300	1,200	1,320	100
NRS6010T 100MMGF	RoHS	10	±20%	25	0.270	1,000	1,100	1,100	1,200	100
NRS6010T 220MMGF	RoHS	22	±20%	12	0.580	650	720	700	740	100

● NRS6012 Shielded type

Parts number	EHS	Nominal inductance [μH]	Inductance tolerance	Self-resonant frequency [MHz] (min.)	DC Resistance [Ω] (±20%)	Rated current ※) [mA]				Measuring frequency [kHz]
						Saturation current: Idc1		Temperature rise current: Idc2		
						Max.	Typ.	Max.	Typ.	
NRS6012T 1R0NMGJ	RoHS	1.0	±30%	95	0.050	3,000	3,900	2,400	2,700	100
NRS6012T 1R5NMGJ	RoHS	1.5	±30%	69	0.067	2,600	3,500	2,100	2,300	100
NRS6012T 2R5NMGJ	RoHS	2.5	±30%	45	0.090	2,100	2,900	1,800	2,100	100
NRS6012T 3R3NMGJ	RoHS	3.3	±30%	42	0.105	1,800	2,500	1,700	1,950	100
NRS6012T 4R7MMGJ	RoHS	4.7	±20%	36	0.125	1,600	2,100	1,550	1,750	100
NRS6012T 5R3MMGJ	RoHS	5.3	±20%	34	0.125	1,500	1,750	1,550	1,750	100
NRS6012T 6R8MMGJ	RoHS	6.8	±20%	30	0.165	1,300	1,600	1,350	1,600	100
NRS6012T 100MMGJ	RoHS	10	±20%	22	0.200	1,000	1,400	1,200	1,380	100
NRS6012T 150MMGJ	RoHS	15	±20%	18	0.295	800	1,100	800	950	100
NRS6012T 220MMGJ	RoHS	22	±20%	12	0.465	760	900	650	750	100
NRS6012T 330MMGJ	RoHS	33	±20%	8	0.580	590	800	550	670	100
NRS6012T 470MMGJ	RoHS	47	±20%	6	0.965	520	630	460	540	100
NRS6012T 680MMGJ	RoHS	68	±20%	3	1.16	440	560	410	450	100
NRS6012T 101MMGJ	RoHS	100	±20%	1	1.67	350	490	320	380	100

※) The saturation current value (Idc1) is the DC current value having inductance decrease down to 30%. (at 20°C)

※) The temperature rise current value (Idc2) is the DC current value having temperature increase up to 40°C. (at 20°C)

※) The rated current is the DC current value that satisfies both of current value saturation current value and temperature rise current value.

▶ This catalog contains the typical specification only due to the limitation of space. When you consider the purchase of our products, please check our product specification sheets. For details of each product (characteristics graph, reliability information, precautions for use, and so on), see our website (<http://www.ty-top.com/>).

■ PARTS NUMBER

● NRS6014 Shielded type

Parts number	EHS	Nominal inductance [ $\mu$ H]	Inductance tolerance	Self-resonant frequency [MHz] (min.)	DC Resistance [ $\Omega$ ] ( $\pm 20\%$ )	Rated current ※) [mA]				Measuring frequency [kHz]
						Saturation current: Idc1		Temperature rise current: Idc2		
						Max.	Typ.	Max.	Typ.	
NRS6014T 1R2NMGG	RoHS	1.2	$\pm 30\%$	77	0.042	4,000	4,400	2,750	3,200	100
NRS6014T 2R2NMGG	RoHS	2.2	$\pm 30\%$	61	0.055	3,000	3,500	2,300	2,600	100
NRS6014T 3R3NMGG	RoHS	3.3	$\pm 30\%$	41	0.075	2,500	2,600	2,000	2,200	100
NRS6014T 4R7MMGG	RoHS	4.7	$\pm 20\%$	36	0.090	2,000	2,170	1,900	1,950	100
NRS6014T 6R8MMGG	RoHS	6.8	$\pm 20\%$	30	0.115	1,700	1,880	1,650	1,700	100
NRS6014T 100MMGG	RoHS	10	$\pm 20\%$	24	0.140	1,400	1,540	1,400	1,500	100
NRS6014T 150MMGG	RoHS	15	$\pm 20\%$	20	0.210	1,150	1,300	1,200	1,280	100
NRS6014T 220MMGG	RoHS	22	$\pm 20\%$	16	0.300	950	1,100	1,000	1,090	100

● NRS6020 Shielded type

Parts number	EHS	Nominal inductance [ $\mu$ H]	Inductance tolerance	Self-resonant frequency [MHz] (min.)	DC Resistance [ $\Omega$ ] ( $\pm 20\%$ )	Rated current ※) [mA]				Measuring frequency [kHz]
						Saturation current: Idc1		Temperature rise current: Idc2		
						Max.	Typ.	Max.	Typ.	
NRS6020T 0R8NMGG	RoHS	0.8	$\pm 30\%$	110	0.020	6,400	7,400	4,100	4,800	100
NRS6020T 1R5NMGG	RoHS	1.5	$\pm 30\%$	93	0.026	4,300	5,300	3,600	4,200	100
NRS6020T 2R2NMGG	RoHS	2.2	$\pm 30\%$	73	0.034	3,200	4,000	2,900	3,400	100
NRS6020T 3R3NMGG	RoHS	3.3	$\pm 30\%$	55	0.040	2,800	3,400	2,750	3,100	100
NRS6020T 4R7NMGG	RoHS	4.7	$\pm 30\%$	43	0.058	2,400	2,800	2,150	2,500	100
NRS6020T 6R8MMGG	RoHS	6.8	$\pm 30\%$	30	0.085	2,000	2,600	1,800	2,100	100
NRS6020T 100MMGG	RoHS	10	$\pm 20\%$	18	0.125	1,900	2,240	1,500	1,700	100
NRS6020T 220MMGG	RoHS	22	$\pm 20\%$	11	0.290	1,250	1,470	950	1,100	100

● NRS6028 Shielded type

Parts number	EHS	Nominal inductance [ $\mu$ H]	Inductance tolerance	Self-resonant frequency [MHz] (min.)	DC Resistance [ $\Omega$ ] ( $\pm 30\%$ )	Rated current ※) [mA]				Measuring frequency [kHz]
						Saturation current: Idc1		Temperature rise current: Idc2		
						Max.	Typ.	Max.	Typ.	
NRS6028T 0R9NMGG	RoHS	0.9	$\pm 30\%$	90	0.013	6,700	7,900	4,600	5,200	100
NRS6028T 1R5NMGG	RoHS	1.5	$\pm 30\%$	78	0.016	5,100	6,100	4,200	4,700	100
NRS6028T 2R2NMGG	RoHS	2.2	$\pm 30\%$	68	0.020	4,200	5,100	3,700	4,200	100
NRS6028T 3R3NMGG	RoHS	3.0	$\pm 30\%$	55	0.023	3,600	4,300	3,400	3,900	100
NRS6028T 4R7MMGG	RoHS	4.7	$\pm 20\%$	39	0.031	2,700	3,300	3,000	3,400	100
NRS6028T 6R8MMGG	RoHS	6.8	$\pm 20\%$	25	0.043	2,600	3,000	2,500	2,900	100
NRS6028T 100MMGG	RoHS	10	$\pm 20\%$	20	0.065	1,900	2,200	1,900	2,200	100
NRS6028T 150MMGG	RoHS	15	$\pm 20\%$	17	0.095	1,600	1,900	1,800	1,900	100
NRS6028T 220MMGG	RoHS	22	$\pm 20\%$	12	0.135	1,300	1,600	1,400	1,600	100
NRS6028T 330MMGG	RoHS	33	$\pm 20\%$	10	0.220	1,100	1,300	1,100	1,250	100
NRS6028T 470MMGG	RoHS	47	$\pm 20\%$	8	0.300	1,000	1,150	920	1,050	100
NRS6028T 680MMGG	RoHS	68	$\pm 20\%$	5	0.420	800	950	770	880	100
NRS6028T 101MMGG	RoHS	100	$\pm 20\%$	3	0.600	650	750	660	750	100

● NRS6045 Shielded type

Parts number	EHS	Nominal inductance [ $\mu$ H]	Inductance tolerance	Self-resonant frequency [MHz] (min.)	DC Resistance [ $\Omega$ ] ( $\pm 30\%$ )	Rated current ※) [mA]				Measuring frequency [kHz]
						Saturation current: Idc1		Temperature rise current: Idc2		
						Max.	Typ.	Max.	Typ.	
NRS6045T 1R0NMGG	RoHS	1.0	$\pm 30\%$	110	0.014	9,800	11,000	4,500	5,200	100
NRS6045T 1R3NMGG	RoHS	1.3	$\pm 30\%$	95	0.016	8,200	9,300	4,200	4,800	100
NRS6045T 1R5NMGG	RoHS	1.5	$\pm 30\%$	95	0.016	8,200	9,300	4,200	4,800	100
NRS6045T 1R8NMGG	RoHS	1.8	$\pm 30\%$	80	0.019	7,200	8,100	3,900	4,400	100
NRS6045T 2R2NMGG	RoHS	2.2	$\pm 30\%$	60	0.022	6,400	7,300	3,600	4,100	100
NRS6045T 2R3NMGG	RoHS	2.3	$\pm 30\%$	60	0.022	6,400	7,300	3,600	4,100	100
NRS6045T 3R0NMGG	RoHS	3.0	$\pm 30\%$	45	0.024	5,600	6,500	3,300	4,000	100
NRS6045T 3R3NMGG	RoHS	3.3	$\pm 30\%$	45	0.024	5,600	6,500	3,300	4,000	100
NRS6045T 4R5MMGG	RoHS	4.5	$\pm 20\%$	25	0.030	4,400	5,400	3,100	3,600	100
NRS6045T 4R7NMGG	RoHS	4.7	$\pm 30\%$	25	0.030	4,400	5,400	3,100	3,600	100
NRS6045T 6R3MMGG	RoHS	6.3	$\pm 20\%$	15	0.036	3,600	4,300	3,000	3,300	100
NRS6045T 6R8MMGG	RoHS	6.8	$\pm 20\%$	15	0.036	3,600	4,300	3,000	3,300	100
NRS6045T 100MMGG	RoHS	10	$\pm 20\%$	12	0.046	3,100	3,600	2,400	2,800	100
NRS6045T 150MMGG	RoHS	15	$\pm 20\%$	10	0.070	2,500	3,000	1,900	2,300	100
NRS6045T 220MMGG	RoHS	22	$\pm 20\%$	7	0.107	2,000	2,400	1,600	1,900	100
NRS6045T 330MMGG	RoHS	33	$\pm 20\%$	6	0.141	1,650	2,000	1,400	1,600	100
NRS6045T 470MMGG	RoHS	47	$\pm 20\%$	5	0.211	1,400	1,600	1,150	1,350	100
NRS6045T 680MMGG	RoHS	68	$\pm 20\%$	4	0.304	1,100	1,300	950	1,100	100
NRS6045T 101MMGG	RoHS	100	$\pm 20\%$	3	0.466	900	1,200	750	900	100

※) The saturation current value (Idc1) is the DC current value having inductance decrease down to 30%. (at 20°C)

※) The temperature rise current value (Idc2) is the DC current value having temperature increase up to 40°C. (at 20°C)

※) The rated current is the DC current value that satisfies both of current value saturation current value and temperature rise current value.

■ PARTS NUMBER

● NRS8030 Shielded type

Parts number	EHS	Nominal inductance [μH]	Inductance tolerance	Self-resonant frequency [MHz] (min.)	DC Resistance [Ω] (±30%)	Rated current ※) [mA]				Measuring frequency [kHz]
						Saturation current: Idc1		Temperature rise current: Idc2		
						Max.	Typ.	Max.	Typ.	
NRS8030T 1R0NJGJ	RoHS	1.0	±30%	120	0.009	7,800	9,300	6,200	7,600	100
NRS8030T 1R5NJGJ	RoHS	1.5	±30%	80	0.012	6,200	7,800	5,300	6,400	100
NRS8030T 2R2NJGJ	RoHS	2.2	±30%	60	0.015	4,900	6,100	4,800	5,600	100
NRS8030T 3R3MJGJ	RoHS	3.3	±20%	50	0.019	4,200	5,200	4,300	5,100	100
NRS8030T 4R7MJGJ	RoHS	4.7	±20%	40	0.022	3,600	4,400	4,000	4,700	100
NRS8030T 6R8MJGJ	RoHS	6.8	±20%	32	0.029	3,000	3,600	3,400	4,000	100
NRS8030T 100MJGJ	RoHS	10	±20%	27	0.033	2,400	2,900	3,000	3,600	100
NRS8030T 150MJGJ	RoHS	15	±20%	20	0.060	2,000	2,300	2,200	2,600	100
NRS8030T 220MJGJ	RoHS	22	±20%	16	0.070	1,750	2,200	1,900	2,300	100
NRS8030T 330MJGJ	RoHS	33	±20%	13	0.120	1,300	1,600	1,500	1,800	100
NRS8030T 470MJGJ	RoHS	47	±20%	11	0.170	1,100	1,400	1,300	1,500	100

● NRS8040 Shielded type

Parts number	EHS	Nominal inductance [μH]	Inductance tolerance	Self-resonant frequency [MHz] (min.)	DC Resistance [Ω] (±30%)	Rated current ※) [mA]				Measuring frequency [kHz]
						Saturation current: Idc1		Temperature rise current: Idc2		
						Max.	Typ.	Max.	Typ.	
NRS8040T 0R9NJGJ	RoHS	0.9	±30%	85	0.006	13,000	14,000	7,800	9,600	100
NRS8040T 1R0NJGJ	RoHS	1	±30%	85	0.006	13,000	14,000	7,800	9,600	100
NRS8040T 1R4NJGJ	RoHS	1.4	±30%	63	0.007	10,000	11,000	7,000	8,400	100
NRS8040T 1R5NJGJ	RoHS	1.5	±30%	63	0.007	10,000	11,000	7,000	8,400	100
NRS8040T 2R0NJGJ	RoHS	2.0	±30%	50	0.009	8,100	9,200	6,300	7,600	100
NRS8040T 2R2NJGJ	RoHS	2.2	±30%	50	0.009	8,100	9,200	6,300	7,600	100
NRS8040T 3R3NJGJ	RoHS	3.3	±30%	34	0.015	6,400	6,800	4,900	6,000	100
NRS8040T 3R6NJGJ	RoHS	3.6	±30%	34	0.015	6,400	6,800	4,900	6,000	100
NRS8040T 4R7NJGJ	RoHS	4.7	±30%	30	0.018	5,400	5,900	4,100	5,200	100
NRS8040T 6R8NJGJ	RoHS	6.8	±30%	24	0.025	4,400	4,800	3,700	4,400	100
NRS8040T 100MJGJ	RoHS	10	±20%	22	0.034	3,800	4,100	3,100	3,500	100
NRS8040T 150MJGJ	RoHS	15	±20%	16	0.050	2,900	3,200	2,400	3,000	100
NRS8040T 220MJGJ	RoHS	22	±20%	13	0.066	2,400	2,700	2,200	2,600	100
NRS8040T 330MJGK	RoHS	33	±20%	12	0.100	2,000	2,300	1,700	1,900	100
NRS8040T 470MJGK	RoHS	47	±20%	8	0.140	1,500	1,800	1,500	1,600	100
NRS8040T 680MJGK	RoHS	68	±20%	7	0.210	1,300	1,500	1,200	1,300	100
NRS8040T 101MJGK	RoHS	100	±20%	6	0.280	1,100	1,300	1,000	1,100	100
NRS8040T 151MJGK	RoHS	150	±20%	5	0.420	900	980	800	890	100
NRS8040T 221MJGK	RoHS	220	±20%	4	0.620	700	800	670	740	100

● NR 3010 Shielded type

Parts number	EHS	Nominal inductance [μH]	Inductance tolerance	Self-resonant frequency [MHz] (min.)	DC Resistance [Ω] (±20%)	Rated current ※) [mA]		Measuring frequency [kHz]
						Saturation current: Idc1	Temperature rise current: Idc2	
						Max.	Max.	
NR 3010T 1R0N	RoHS	1.0	±30%	126	0.065	1,300	1,400	100
NR 3010T 1R5N	RoHS	1.5	±30%	98	0.080	1,200	1,300	100
NR 3010T 2R2M	RoHS	2.2	±20%	82	0.095	1,100	1,100	100
NR 3010T 3R3M	RoHS	3.3	±20%	63	0.140	870	940	100
NR 3010T 4R7M	RoHS	4.7	±20%	56	0.190	750	780	100
NR 3010T 6R8M	RoHS	6.8	±20%	46	0.300	610	630	100
NR 3010T 100M	RoHS	10	±20%	35	0.450	500	510	100
NR 3010T 150M	RoHS	15	±20%	30	0.740	400	400	100
NR 3010T 220M	RoHS	22	±20%	25	1.03	350	350	100
NR 3010T 330M	RoHS	33	±20%	20	1.55	260	275	100
NR 3010T 470M	RoHS	47	±20%	17	2.05	220	235	100

● NR 3012 Shielded type

Parts number	EHS	Nominal inductance [μH]	Inductance tolerance	Self-resonant frequency [MHz] (min.)	DC Resistance [Ω] (±20%)	Rated current ※) [mA]		Measuring frequency [kHz]
						Saturation current: Idc1	Temperature rise current: Idc2	
						Max.	Max.	
NR 3012T 1R0N	RoHS	1.0	±30%	110	0.050	1,500	1,490	100
NR 3012T 1R5N	RoHS	1.5	±30%	92	0.060	1,360	1,400	100
NR 3012T 2R2M	RoHS	2.2	±20%	70	0.080	1,100	1,200	100
NR 3012T 3R3M	RoHS	3.3	±20%	55	0.100	910	1,050	100
NR 3012T 4R7M	RoHS	4.7	±20%	48	0.130	770	980	100
NR 3012T 6R8M	RoHS	6.8	±20%	40	0.190	670	740	100
NR 3012T 100M	RoHS	10	±20%	32	0.290	540	630	100
NR 3012T 150M	RoHS	15	±20%	27	0.450	440	485	100
NR 3012T 220M	RoHS	22	±20%	22	0.630	375	420	100
NR 3012T 330M	RoHS	33	±20%	19	1.03	310	330	100
NR 3012T 470M	RoHS	47	±20%	17	1.45	250	280	100

※) The saturation current value (Idc1) is the DC current value having inductance decrease down to 30%. (at 20°C)

※) The temperature rise current value (Idc2) is the DC current value having temperature increase up to 40°C. (at 20°C)

※) The rated current is the DC current value that satisfies both of current value saturation current value and temperature rise current value.

■ PARTS NUMBER

● NR 3015 Shielded type

Parts number	EHS	Nominal inductance [ $\mu$ H]	Inductance tolerance	Self-resonant frequency [MHz] (min.)	DC Resistance [ $\Omega$ ] ( $\pm 20\%$ )	Rated current ※) [mA]		Measuring frequency [kHz]
						Saturation current: Idc1 Max.	Temperature rise current: Idc2 Max.	
NR 3015T 1R0N	RoHS	1.0	$\pm 30\%$	100	0.030	2,100	2,100	100
NR 3015T 1R5N	RoHS	1.5	$\pm 30\%$	87	0.040	1,800	1,820	100
NR 3015T 2R2M	RoHS	2.2	$\pm 20\%$	64	0.060	1,480	1,500	100
NR 3015T 3R3M	RoHS	3.3	$\pm 20\%$	49	0.080	1,210	1,230	100
NR 3015T 4R7M	RoHS	4.7	$\pm 20\%$	40	0.120	1,020	1,040	100
NR 3015T 6R8M	RoHS	6.8	$\pm 20\%$	36	0.160	870	880	100
NR 3015T 100M	RoHS	10	$\pm 20\%$	28	0.230	700	710	100
NR 3015T 150M	RoHS	15	$\pm 20\%$	23	0.360	560	560	100
NR 3015T 220M	RoHS	22	$\pm 20\%$	20	0.520	470	470	100
NR 3015T 330M	RoHS	33	$\pm 20\%$	18	0.840	390	370	100
NR 3015T 470M	RoHS	47	$\pm 20\%$	17	1.34	320	300	100

● NR 4010 Shielded type

Parts number	EHS	Nominal inductance [ $\mu$ H]	Inductance tolerance	Self-resonant frequency [MHz] (min.)	DC Resistance [ $\Omega$ ] ( $\pm 20\%$ )	Rated current ※) [mA]		Measuring frequency [kHz]
						Saturation current: Idc1 Max.	Temperature rise current: Idc2 Max.	
NR 4010T 1R0N	RoHS	1.0	$\pm 30\%$	116	0.100	1,800	1,050	100
NR 4010T 2R2N	RoHS	2.2	$\pm 30\%$	73	0.150	1,150	890	100
NR 4010T 3R3M	RoHS	3.3	$\pm 20\%$	58	0.180	1,100	820	100
NR 4010T 4R7M	RoHS	4.7	$\pm 20\%$	47	0.210	900	750	100
NR 4010T 6R8M	RoHS	6.8	$\pm 20\%$	38	0.300	740	620	100
NR 4010T 100M	RoHS	10	$\pm 20\%$	31	0.380	560	600	100
NR 4010T 150M	RoHS	15	$\pm 20\%$	24	0.510	470	510	100
NR 4010T 220M	RoHS	22	$\pm 20\%$	19	0.870	360	400	100
NR 4010T 330M	RoHS	33	$\pm 20\%$	15	1.54	280	300	100
NR 4010T 470M	RoHS	47	$\pm 20\%$	13	1.81	240	280	100

● NR 4012 Shielded type

Parts number	EHS	Nominal inductance [ $\mu$ H]	Inductance tolerance	Self-resonant frequency [MHz] (min.)	DC Resistance [ $\Omega$ ] ( $\pm 20\%$ )	Rated current ※) [mA]		Measuring frequency [kHz]
						Saturation current: Idc1 Max.	Temperature rise current: Idc2 Max.	
NR 4012T 1R0N	RoHS	1.0	$\pm 30\%$	131	0.060	2,500	1,500	100
NR 4012T 2R2M	RoHS	2.2	$\pm 20\%$	66	0.090	1,650	1,200	100
NR 4012T 3R3M	RoHS	3.3	$\pm 20\%$	50	0.130	1,200	980	100
NR 4012T 4R7M	RoHS	4.7	$\pm 20\%$	45	0.140	1,050	960	100
NR 4012T 6R8M	RoHS	6.8	$\pm 20\%$	35	0.180	900	840	100
NR 4012T 100M	RoHS	10	$\pm 20\%$	28	0.240	740	770	100
NR 4012T 150M	RoHS	15	$\pm 20\%$	23	0.400	560	600	100
NR 4012T 220M	RoHS	22	$\pm 20\%$	18	0.480	510	540	100
NR 4012T 330M	RoHS	33	$\pm 20\%$	15	0.810	400	420	100
NR 4012T 470M	RoHS	47	$\pm 20\%$	12	1.00	350	370	100

● NR 4018 Shielded type

Parts number	EHS	Nominal inductance [ $\mu$ H]	Inductance tolerance	Self-resonant frequency [MHz] (min.)	DC Resistance [ $\Omega$ ] ( $\pm 20\%$ )	Rated current ※) [mA]		Measuring frequency [kHz]
						Saturation current: Idc1 Max.	Temperature rise current: Idc2 Max.	
NR 4018T 1R0N	RoHS	1.0	$\pm 30\%$	80	0.030	4,000	1,830	100
NR 4018T 2R2M	RoHS	2.2	$\pm 20\%$	52	0.060	2,700	1,440	100
NR 4018T 3R3M	RoHS	3.3	$\pm 20\%$	44	0.070	2,000	1,230	100
NR 4018T 4R7M	RoHS	4.7	$\pm 20\%$	34	0.090	1,700	1,200	100
NR 4018T 6R8M	RoHS	6.8	$\pm 20\%$	29	0.110	1,450	1,060	100
NR 4018T 100M	RoHS	10	$\pm 20\%$	24	0.180	1,200	840	100
NR 4018T 150M	RoHS	15	$\pm 20\%$	19	0.250	940	650	100
NR 4018T 220M	RoHS	22	$\pm 20\%$	16	0.360	800	590	100
NR 4018T 330M	RoHS	33	$\pm 20\%$	12	0.530	650	490	100
NR 4018T 470M	RoHS	47	$\pm 20\%$	10	0.650	570	420	100
NR 4018T 680M	RoHS	68	$\pm 20\%$	8.3	1.00	470	320	100
NR 4018T 101M	RoHS	100	$\pm 20\%$	6.5	1.50	400	270	100
NR 4018T 151M	RoHS	150	$\pm 20\%$	5.5	2.50	310	220	100
NR 4018T 221M	RoHS	220	$\pm 20\%$	4.0	4.00	270	170	100

● NR 5040 Shielded type

Parts number	EHS	Nominal inductance [ $\mu$ H]	Inductance tolerance	Self-resonant frequency [MHz] (min.)	DC Resistance [ $\Omega$ ] ( $\pm 30\%$ )	Rated current ※) [mA]		Measuring frequency [kHz]
						Saturation current: Idc1 Max.	Temperature rise current: Idc2 Max.	
NR 5040T 1R5N	RoHS	1.5	$\pm 30\%$	60	0.020	6,000	3,600	100
NR 5040T 2R2N	RoHS	2.2	$\pm 30\%$	42	0.022	4,600	3,500	100
NR 5040T 3R3N	RoHS	3.3	$\pm 30\%$	32	0.027	3,800	3,300	100
NR 5040T 4R7N	RoHS	4.7	$\pm 30\%$	28	0.029	3,300	3,100	100
NR 5040T 6R8M	RoHS	6.8	$\pm 20\%$	21	0.049	2,600	2,300	100
NR 5040T 100M	RoHS	10	$\pm 20\%$	18	0.056	2,300	2,100	100
NR 5040T 150M	RoHS	15	$\pm 20\%$	13	0.080	2,000	1,800	100
NR 5040T 220M	RoHS	22	$\pm 20\%$	9	0.126	1,600	1,400	100
NR 5040T 330M	RoHS	33	$\pm 20\%$	7	0.180	1,300	1,200	100
NR 5040T 470M	RoHS	47	$\pm 20\%$	6	0.310	1,100	900	100

※) The saturation current value (Idc1) is the DC current value having inductance decrease down to 30%. (at 20°C)

※) The temperature rise current value (Idc2) is the DC current value having temperature increase up to 40°C. (at 20°C)

※) The rated current is the DC current value that satisfies both of current value saturation current value and temperature rise current value.

► This catalog contains the typical specification only due to the limitation of space. When you consider the purchase of our products, please check our product specification sheets. For details of each product (characteristics graph, reliability information, precautions for use, and so on), see our website (<http://www.ty-top.com/>).

## ● NR 6012 Shielded type

Parts number	EHS	Nominal inductance [ $\mu$ H]	Inductance tolerance	Self-resonant frequency [MHz] (min.)	DC Resistance [ $\Omega$ ] ( $\pm 20\%$ )	Rated current ※) [mA]		Measuring frequency [kHz]
						Saturation current: Idc1 Max.	Temperature rise current: Idc2 Max.	
NR 6012T 2R5NE	RoHS	2.5	$\pm 30\%$	45	0.090	2,100	1,730	100
NR 6012T 4R0NE	RoHS	4.0	$\pm 30\%$	39	0.105	1,800	1,570	100
NR 6012T 5R3ME	RoHS	5.3	$\pm 20\%$	34	0.125	1,500	1,400	100
NR 6012T 6R8ME	RoHS	6.8	$\pm 20\%$	30	0.165	1,300	1,180	100
NR 6012T 100ME	RoHS	10	$\pm 20\%$	22	0.235	1,000	1,000	100
NR 6012T 150ME	RoHS	15	$\pm 20\%$	18	0.330	800	790	100
NR 6012T 220ME	RoHS	22	$\pm 20\%$	12	0.530	760	630	100
NR 6012T 330ME	RoHS	33	$\pm 20\%$	8	0.700	590	530	100
NR 6012T 470ME	RoHS	47	$\pm 20\%$	6	1.05	520	460	100
NR 6012T 680ME	RoHS	68	$\pm 20\%$	3	1.35	440	410	100
NR 6012T 101ME	RoHS	100	$\pm 20\%$	1	2.18	350	320	100

## ● NR 6020 Shielded type

Parts number	EHS	Nominal inductance [ $\mu$ H]	Inductance tolerance	Self-resonant frequency [MHz] (min.)	DC Resistance [ $\Omega$ ] ( $\pm 20\%$ )	Rated current ※) [mA]		Measuring frequency [kHz]
						Saturation current: Idc1 Max.	Temperature rise current: Idc2 Max.	
NR 6020T 0R8N	RoHS	0.8	$\pm 30\%$	110	0.020	5,500	3,800	100
NR 6020T 1R5N	RoHS	1.5	$\pm 30\%$	93	0.026	4,000	3,200	100
NR 6020T 2R2N	RoHS	2.2	$\pm 30\%$	73	0.034	3,200	2,700	100
NR 6020T 3R3N	RoHS	3.3	$\pm 30\%$	55	0.040	2,800	2,600	100
NR 6020T 4R7N	RoHS	4.7	$\pm 30\%$	43	0.058	2,400	2,000	100
NR 6020T 6R8N	RoHS	6.8	$\pm 30\%$	30	0.085	2,000	1,800	100
NR 6020T 100M	RoHS	10	$\pm 20\%$	18	0.125	1,700	1,400	100
NR 6020T 220M	RoHS	22	$\pm 20\%$	11	0.290	1,050	950	100

## ● NR 6028 Shielded type

Parts number	EHS	Nominal inductance [ $\mu$ H]	Inductance tolerance	Self-resonant frequency [MHz] (min.)	DC Resistance [ $\Omega$ ] ( $\pm 30\%$ )	Rated current ※) [mA]		Measuring frequency [kHz]
						Saturation current: Idc1 Max.	Temperature rise current: Idc2 Max.	
NR 6028T 0R9N	RoHS	0.9	$\pm 30\%$	90	0.013	6,600	4,600	100
NR 6028T 1R5N	RoHS	1.5	$\pm 30\%$	78	0.016	5,000	4,200	100
NR 6028T 2R2N	RoHS	2.2	$\pm 30\%$	68	0.020	4,200	3,700	100
NR 6028T 3R0N	RoHS	3.0	$\pm 30\%$	55	0.023	3,600	3,400	100
NR 6028T 4R7M	RoHS	4.7	$\pm 20\%$	39	0.031	2,700	3,000	100
NR 6028T 6R0M	RoHS	6.0	$\pm 20\%$	30	0.040	2,500	2,500	100
NR 6028T 100M	RoHS	10	$\pm 20\%$	20	0.065	1,900	1,900	100
NR 6028T 150M	RoHS	15	$\pm 20\%$	17	0.095	1,600	1,800	100
NR 6028T 220M	RoHS	22	$\pm 20\%$	12	0.135	1,300	1,400	100
NR 6028T 330M	RoHS	33	$\pm 20\%$	10	0.220	1,100	1,100	100
NR 6028T 470M	RoHS	47	$\pm 20\%$	8	0.300	950	920	100
NR 6028T 680M	RoHS	68	$\pm 20\%$	5	0.420	760	770	100
NR 6028T 101M	RoHS	100	$\pm 20\%$	3	0.600	620	660	100

## ● NR 6045 Shielded type

Parts number	EHS	Nominal inductance [ $\mu$ H]	Inductance tolerance	Self-resonant frequency [MHz] (min.)	DC Resistance [ $\Omega$ ] ( $\pm 30\%$ )	Rated current ※) [mA]		Measuring frequency [kHz]
						Saturation current: Idc1 Max.	Temperature rise current: Idc2 Max.	
NR 6045T 1R0N	RoHS	1.0	$\pm 30\%$	110	0.014	8,500	4,200	100
NR 6045T 1R3N	RoHS	1.3	$\pm 30\%$	95	0.016	8,000	4,000	100
NR 6045T 1R8N	RoHS	1.8	$\pm 30\%$	80	0.018	7,000	3,700	100
NR 6045T 2R3N	RoHS	2.3	$\pm 30\%$	60	0.021	6,000	3,500	100
NR 6045T 3R0N	RoHS	3.0	$\pm 30\%$	45	0.024	5,000	3,200	100
NR 6045T 4R5M	RoHS	4.5	$\pm 20\%$	25	0.031	4,000	3,000	100
NR 6045T 6R3M	RoHS	6.3	$\pm 20\%$	15	0.038	3,800	2,800	100
NR 6045T 100M	RoHS	10	$\pm 20\%$	12	0.047	3,000	2,500	100
NR 6045T 150M	RoHS	15	$\pm 20\%$	10	0.077	2,300	1,900	100
NR 6045T 220M	RoHS	22	$\pm 20\%$	7	0.115	1,900	1,500	100
NR 6045T 330M	RoHS	33	$\pm 20\%$	6	0.145	1,500	1,400	100
NR 6045T 470M	RoHS	47	$\pm 20\%$	5	0.220	1,300	1,100	100
NR 6045T 680M	RoHS	68	$\pm 20\%$	4	0.330	1,000	900	100
NR 6045T 101M	RoHS	100	$\pm 20\%$	3	0.500	800	700	100

## ● NR 8040 Shielded type

Parts number	EHS	Nominal inductance [ $\mu$ H]	Inductance tolerance	Self-resonant frequency [MHz] (min.)	DC Resistance [ $\Omega$ ] ( $\pm 30\%$ )	Rated current ※) [mA]		Measuring frequency [kHz]
						Saturation current: Idc1 Max.	Temperature rise current: Idc2 Max.	
NR 8040T 0R9N	RoHS	0.9	$\pm 30\%$	85	0.006	11,000	7,800	100
NR 8040T 1R4N	RoHS	1.4	$\pm 30\%$	63	0.007	9,000	7,000	100
NR 8040T 2R0N	RoHS	2.0	$\pm 30\%$	50	0.009	7,400	6,300	100
NR 8040T 3R6N	RoHS	3.6	$\pm 30\%$	34	0.015	5,300	4,900	100
NR 8040T 4R7N	RoHS	4.7	$\pm 30\%$	30	0.018	4,700	4,100	100
NR 8040T 6R8N	RoHS	6.8	$\pm 30\%$	24	0.025	4,000	3,700	100
NR 8040T 100M	RoHS	10	$\pm 20\%$	22	0.034	3,400	3,100	100
NR 8040T 150M	RoHS	15	$\pm 20\%$	16	0.050	2,700	2,400	100
NR 8040T 220M	RoHS	22	$\pm 20\%$	13	0.066	2,200	2,200	100
NR 8040T 330M	RoHS	33	$\pm 20\%$	12	0.100	1,900	1,700	100
NR 8040T 470M	RoHS	47	$\pm 20\%$	8	0.150	1,500	1,400	100
NR 8040T 680M	RoHS	68	$\pm 20\%$	7	0.230	1,200	1,100	100
NR 8040T 101M	RoHS	100	$\pm 20\%$	6	0.290	1,000	1,000	100

※) The saturation current value (Idc1) is the DC current value having inductance decrease down to 30%. (at 20°C)

※) The temperature rise current value (Idc2) is the DC current value having temperature increase up to 40°C. (at 20°C)

※) The rated current is the DC current value that satisfies both of current value saturation current value and temperature rise current value.

► This catalog contains the typical specification only due to the limitation of space. When you consider the purchase of our products, please check our product specification sheets. For details of each product (characteristics graph, reliability information, precautions for use, and so on), see our website (<http://www.ty-top.com/>).

# SMD POWER INDUCTORS (NR SERIES/NR SERIES H TYPE/M TYPE/S TYPE/V TYPE)

## PACKAGING

### ① Minimum Quantity

Type	Standard Quantity [pcs]
	Tape & Reel
NRV2010	2500
NRS2012	2500
NRV2012	2500
NRH2410	2500
NRH2412	2500
NR 3010	2000
NRH3010	2000
NR 3012	2000
NRH3012	2000
NRV3012	2000
NR 3015	2000
NRS3015	2000
NR 4010	5000
NRS4010	5000
NR 4012	4500
NRS4012	4500
NR 4018	3500
NRS4018	3500

Type	Standard Quantity [pcs]
	Tape & Reel
NRS5010	1000
NRS5012	1000
NRS5014	1000
NRS5020	800
NRS5024	2500
NRS5030	500
NR 5040	1500
NRS5040	1500
NRS6010	1000
NR 6012	1000
NRS6012	1000
NRS6014	1000
NR 6020	2500
NRS6020	2500
NR 6028	2000
NRS6028	2000
NR 6045	1500
NRM6045	1500
NRS6045	1500
NRS8030	1000
NR 8040	1000
NRS8040	1000

### ② Tape Material

#### ● Embossed Tape

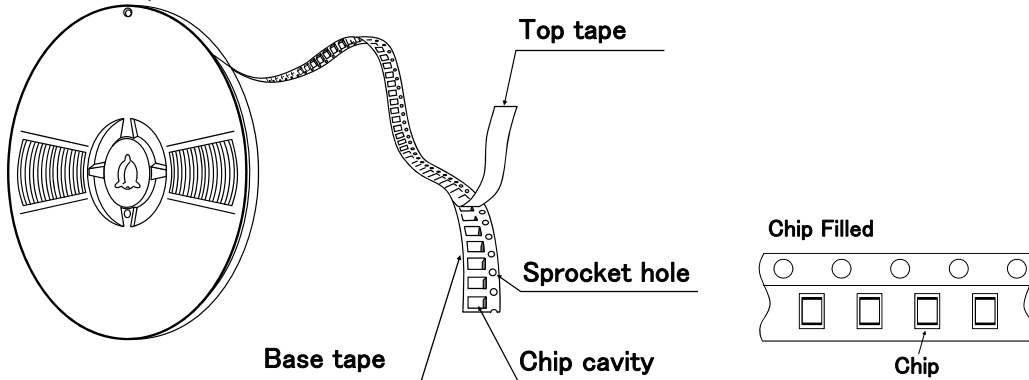

### ③ Taping dimensions

#### ● Embossed tape 8mm wide (0.315 inches wide)

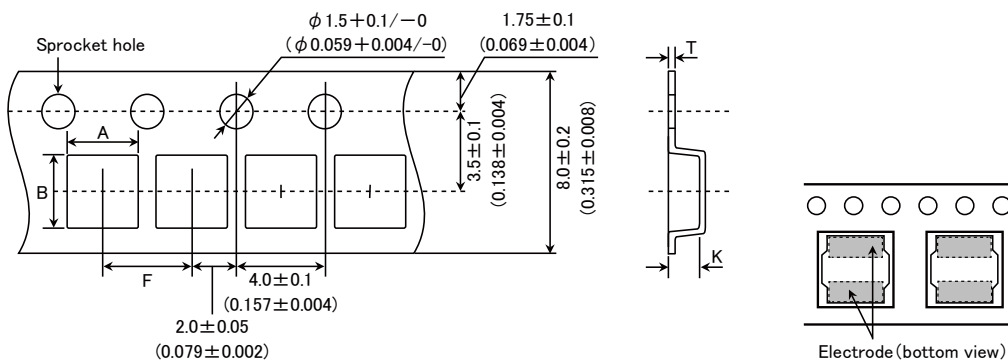

▶ This catalog contains the typical specification only due to the limitation of space. When you consider the purchase of our products, please check our specification. For details of each product (characteristics graph, reliability information, precautions for use, and so on), see our Web site (<http://www.ty-top.com/>).

Type	Chip cavity		Insertion pitch	Tape thickness	
	A	B		T	K
NRV2010	2.2±0.1 (0.102±0.004)	2.2±0.1 (0.102±0.004)	4.0±0.1 (0.157±0.004)	0.25±0.05 (0.009±0.002)	1.3±0.1 (0.051±0.004)
NRS2012 NRV2012					
NRH2410	2.6±0.1 (0.087±0.004)	2.6±0.1 (0.102±0.004)		0.25±0.05 (0.009±0.002)	1.3±0.1 (0.051±0.004)
NRH2412					
NR 3010 NRH3010	3.2±0.1 (0.126±0.004)	3.2±0.1 (0.126±0.004)		0.3±0.05 (0.012±0.002)	1.4±0.1 (0.055±0.004)
NR 3012 NRH3012 NRV3012					1.6±0.1 (0.063±0.004)
NR 3015 NRS3015			1.9±0.1 (0.075±0.004)		

Unit : mm (inch)

● Embossed tape 12mm wide (0.47 inches wide)

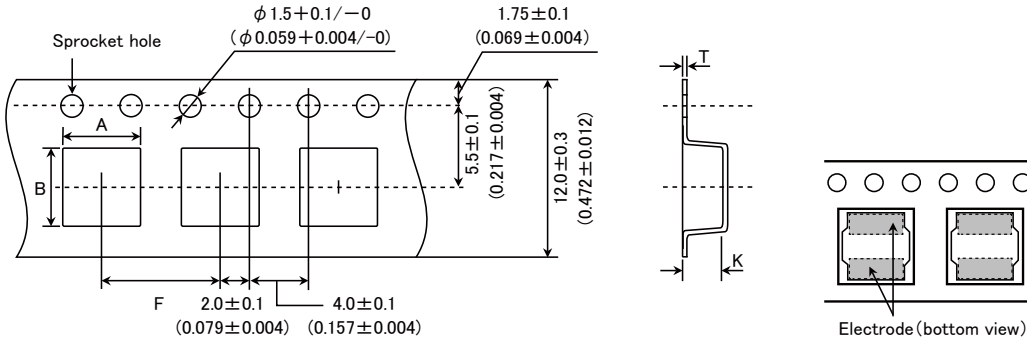

Type	Chip cavity		Insertion pitch	Tape thickness	
	A	B		T	K
NR 4010 NRS4010	4.3±0.1 (0.169±0.004)	4.3±0.1 (0.169±0.004)	8.0±0.1 (0.315±0.004)	0.3±0.1 (0.012±0.004)	1.4±0.1 (0.055±0.004)
NR 4012 NRS4012					1.6±0.1 (0.063±0.004)
NR 4018 NRS4018	2.1±0.1 (0.083±0.004)				
NRS5010	5.25±0.1 (0.207±0.004)	5.25±0.1 (0.207±0.004)			1.4±0.1 (0.055±0.004)
NRS5012					1.4±0.1 (0.055±0.004)
NRS5014					1.6±0.1 (0.063±0.004)
NRS5020			2.3±0.1 (0.091±0.004)		
NRS5024	5.15±0.1 (0.203±0.004)	5.15±0.1 (0.203±0.004)	2.7±0.1 (0.106±0.004)		
NRS5030			3.2±0.1 (0.126±0.004)		
NR 5040 NRS5040	5.15±0.1 (0.203±0.004)	5.15±0.1 (0.203±0.004)	0.4±0.1 (0.016±0.004)	4.2±0.1 (0.165±0.004)	
NRS6010				1.4±0.1 (0.055±0.004)	
NR 6012 NRS6012	6.3±0.1 (0.248±0.004)	6.3±0.1 (0.248±0.004)		1.6±0.1 (0.063±0.004)	
NRS6014				1.6±0.1 (0.063±0.004)	
NR 6020 NRS6020				2.3±0.1 (0.090±0.004)	
NR 6028 NRS6028				3.1±0.1 (0.122±0.004)	
NR 6045 NRM6045 NRS6045	6.3±0.1 (0.248±0.004)	6.3±0.1 (0.248±0.004)	4.7±0.1 (0.185±0.004)		

Unit : mm (inch)

▶ This catalog contains the typical specification only due to the limitation of space. When you consider the purchase of our products, please check our specification. For details of each product (characteristics graph, reliability information, precautions for use, and so on), see our Web site (<http://www.ty-top.com/>).

● Embossed tape 16mm wide (0.63 inches wide)

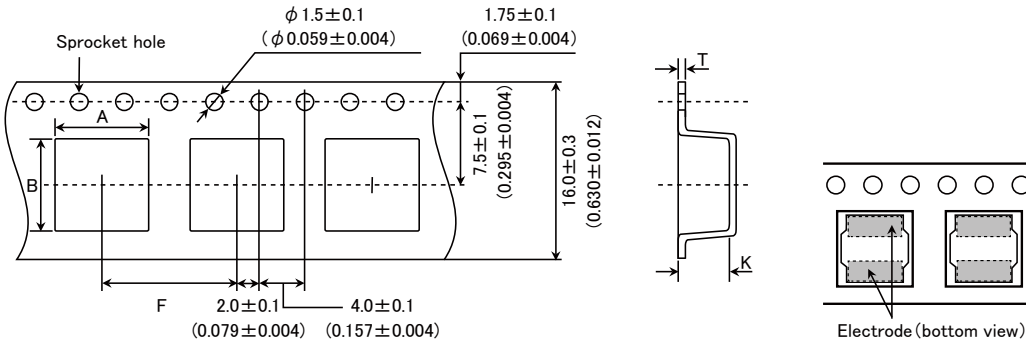

Type	Chip cavity		Insertion pitch F	Tape thickness	
	A	B		T	K
NRS8030	8.3±0.1 (0.327±0.004)	8.3±0.1 (0.327±0.004)	12.0±0.1 (0.472±0.004)	0.5±0.1 (0.020±0.004)	3.4±0.1 (0.134±0.004)
NR 8040 NRS8040					4.5±0.1 (0.177±0.004)

Unit : mm (inch)

④ Leader and Blank portion

● NR, NRH, NRS, NRV

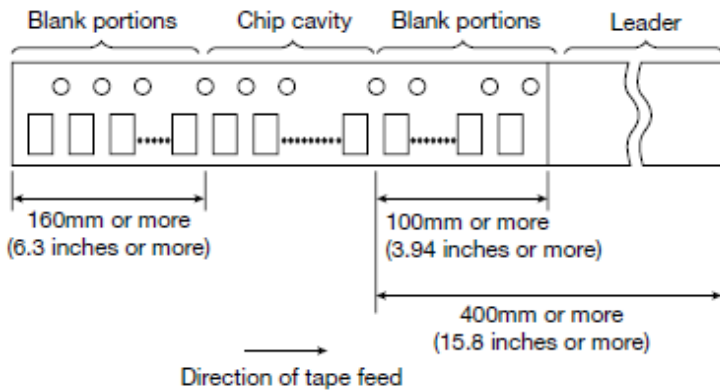

⑤ Reel size

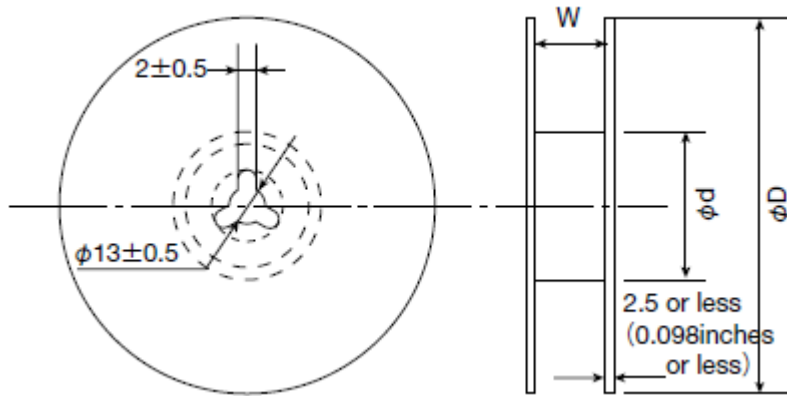

Type	Reel size (Reference values)		
	$\phi D$	$\phi d$	W
NRV2010	180±0.5 (7.087±0.019)	60±1.0 (2.36±0.04)	10.0±1.5 (0.394±0.059)
NRS2012			
NRV2012			
NRH2410			
NRH2412			
NR 3010			
NRH3010			
NR 3012			
NRH3012			
NRV3012			
NR 3015	180±0.5 (7.087±0.019)	60±1.0 (2.36±0.04)	10.0±1.5 (0.394±0.059)
NRS3015			

▶ This catalog contains the typical specification only due to the limitation of space. When you consider the purchase of our products, please check our specification. For details of each product (characteristics graph, reliability information, precautions for use, and so on), see our Web site (<http://www.ty-top.com/>).

NRS5010	180±3.0 (7.087±0.118)	60±2.0 (2.36±0.08)	14.0±1.5 (0.551±0.059)
NRS5012			
NRS5014			
NRS5020			
NRS5030			
NRS6010			
NR 6012			
NRS6012			
NRS6014			

Unit: mm (inch)

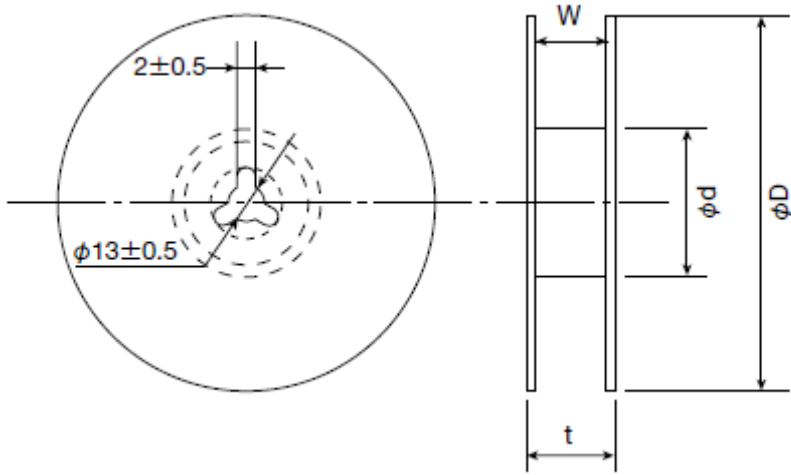

Type	Reel size (Reference values)			
	φD	φd	t (max.)	W
NR 4010	330±3.0 (12.99±0.118)	80±2.0 (3.15±0.078)	18.5 (0.72)	13.5±1.0 (0.531±0.04)
NRS4010				
NR 4012				
NRS4012				
NR 4018				
NRS4018				
NRS5024				
NR 5040				
NRS5040				
NR 6020				
NRS6020				
NR 6028				
NRS6028				
NR 6045				
NRM6045				
NRS6045				
NRS8030	22.5 (0.89)	17.5±1.0 (0.689±0.04)		
NR 8040				
NRS8040				

Unit: mm (inch)

### ⑥ Top Tape Strength

The top tape requires a peel-off force of 0.1 to 1.3N in the direction of the arrow as illustrated below.

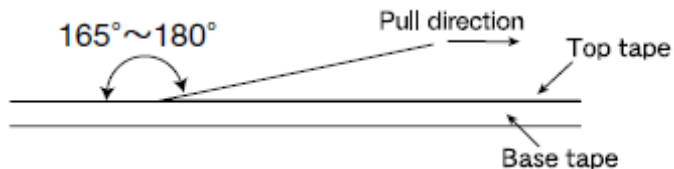

▶ This catalog contains the typical specification only due to the limitation of space. When you consider the purchase of our products, please check our specification. For details of each product (characteristics graph, reliability information, precautions for use, and so on), see our Web site (<http://www.ty-top.com/>).

# SMD POWER INDUCTORS (NR□, NS SERIES)

## RELIABILITY DATA

1. Operating Temperature Range		
Specified Value	NR30/40/50/60/80, NRS20, NRV20/30, NRH24/30 Type	-25~+120°C
	NRS40/50/60/80 Type	-25~+125°C
	NR10050 Type	-25~+105°C
	NS101, NS125 Type	-40~+125°C
Test Methods and Remarks	Including self-generated heat	
2. Storage Temperature Range		
Specified Value	NR30/40/50/60/80, NRV20/30, NRH24/30, NRS20/40/50/60/80 Type	-40~+85°C
	NR10050 Type	
	NS101, NS125 Type	
Test Methods and Remarks	NR30/40/50/60/80, NRV20/30, NRH24/30, NRS20/40/50/60/80 Type, NR10050 Type, NS101/125 Type : -5 to 40°C for the product with taping.	
3. Rated current		
Specified Value	NR30/40/50/60/80, NRV20/30, NRH24/30, NRS20/40/50/60/80 Type	Within the specified tolerance
	NR10050 Type	
	NS101, NS125 Type	
4. Inductance		
Specified Value	NR30/40/50/60/80, NRV20/30, NRH24/30, NRS20/40/50/60/80 Type	Within the specified tolerance
	NR10050 Type	
	NS101, NS125 Type	
Test Methods and Remarks	Measuring equipment : LCR Meter (HP 4285A or equivalent) Measuring frequency : Specified frequency NR30/40/50/60/80, NRV20/30, NRH24/30, NRS20/40/50/60/80 Type, NR10050 Type, NS101/125 Type : Measuring equipment : LCR Meter (HP 4285A or equivalent) Measuring frequency : 100kHz, 1V NR10050 Type : Measuring equipment : LCR Meter (HP 4263A or equivalent) Measuring frequency : 100kHz, 1V	
5. DC Resistance		
Specified Value	NR30/40/50/60/80, NRV20/30, NRH24/30, NRS20/40/50/60/80 Type	Within the specified tolerance
	NR10050 Type	
	NS101, NS125 Type	
Test Methods and Remarks	Measuring equipment : DC ohmmeter (HIOKI 3227 or equivalent)	
6. Self resonance frequency		
Specified Value	NR30/40/50/60/80, NRV30, NRH24/30, NRS40/50/60/80 Type	Within the specified tolerance
	NR10050 Type	
	NS101, NS125 Type	-
Test Methods and Remarks	NR30/40/50/60/80, NRV30, NRH24/30, NRS40/50/60/80 Type, NR10050 Type : Measuring equipment : Impedance analyzer/material analyzer (HP4291A or equivalent HP4191A, 4192A or equivalent)	

▶ This catalog contains the typical specification only due to the limitation of space. When you consider the purchase of our products, please check our specification.  
 For details of each product (characteristics graph, reliability information, precautions for use, and so on), see our Web site (<http://www.ty-top.com/>).

7. Temperature characteristic														
Specified Value	NR30/40/50/60/80, NRV20/30, NRH24/30, NRS20/40/50/60/80 Type	Inductance change : Within $\pm 20\%$												
	NR10050 Type													
	NS101, NS125 Type	Inductance change : Within $\pm 15\%$												
Test Methods and Remarks	NR30/40/50/60/80, NRV20/30, NRH24/30, NRS20/40/50/60/80 Type, NR10050 Type : Measurement of inductance shall be taken at temperature range within $-25^{\circ}\text{C}\sim +85^{\circ}\text{C}$ . With reference to inductance value at $+20^{\circ}\text{C}$ ., change rate shall be calculated.													
	NS101, NS125 Type : Measurement of inductance shall be taken at temperature range within $-40^{\circ}\text{C}\sim +125^{\circ}\text{C}$ . With reference to inductance value at $+20^{\circ}\text{C}$ ., change rate shall be calculated. Change of maximum inductance deviation in step 1 to 5													
	<table border="1"> <thead> <tr> <th>Step</th> <th>Temperature (<math>^{\circ}\text{C}</math>)</th> </tr> </thead> <tbody> <tr> <td>1</td> <td>20</td> </tr> <tr> <td>2</td> <td>Minimum operating temperature</td> </tr> <tr> <td>3</td> <td>20 (Standard temperature)</td> </tr> <tr> <td>4</td> <td>Maximum operating temperature</td> </tr> <tr> <td>5</td> <td>20</td> </tr> </tbody> </table>	Step	Temperature ( $^{\circ}\text{C}$ )	1	20	2	Minimum operating temperature	3	20 (Standard temperature)	4	Maximum operating temperature	5	20	
Step	Temperature ( $^{\circ}\text{C}$ )													
1	20													
2	Minimum operating temperature													
3	20 (Standard temperature)													
4	Maximum operating temperature													
5	20													

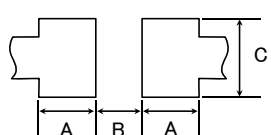
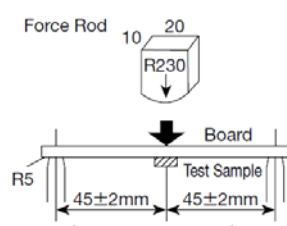
8. Resistance to flexure of substrate																																												
Specified Value	NR30/40/50/60/80, NRV20/30, NRH24/30, NRS20/40/50/60/80 Type	No damage																																										
	NR10050 Type	—																																										
	NS101, NS125 Type	No damage																																										
Test Methods and Remarks	NR30/40/50/60/80, NRV20/30, NRH24/30, NRS20/40/50/60/80 Type, NS101/125 Type : The test samples shall be soldered to the test board by the reflow. As illustrated below, apply force in the direction of the arrow indicating until deflection of the test board reaches to 2 mm. Test board size : $100 \times 40 \times 1.0$ Test board material : Glass epoxy-resin Solder cream thickness : 0.10mm (NR30, NRS20, NRH24/30, NRV20/30) : 0.15mm (NR40/50/60/80, NRS40/50/60, NS101/125Type)																																											
	<div style="display: flex; align-items: center;"> <div style="margin-right: 20px;"> <p>Land dimension</p>  </div> <table border="1"> <thead> <tr> <th>Type</th> <th>A</th> <th>B</th> <th>C</th> </tr> </thead> <tbody> <tr> <td>NRS20, NRV20</td> <td>0.65</td> <td>0.7</td> <td>2.0</td> </tr> <tr> <td>NRH24</td> <td>0.7</td> <td>0.75</td> <td>2.0</td> </tr> <tr> <td>NR30, NRV30, NRH30</td> <td>0.8</td> <td>1.4</td> <td>2.7</td> </tr> <tr> <td>NR40, NRS40</td> <td>1.2</td> <td>1.6</td> <td>3.7</td> </tr> <tr> <td>NR50, NRS50</td> <td>1.5</td> <td>2.1</td> <td>4.0</td> </tr> <tr> <td>NR60, NRS60</td> <td>1.6</td> <td>3.1</td> <td>5.7</td> </tr> <tr> <td>NR80, NRS80</td> <td>1.8</td> <td>3.8</td> <td>7.5</td> </tr> </tbody> </table> </div> <div style="margin-left: 20px;">  <table border="1"> <thead> <tr> <th>Type</th> <th>A</th> <th>B</th> <th>C</th> </tr> </thead> <tbody> <tr> <td>NS101</td> <td>2.5</td> <td>5.6</td> <td>3.2</td> </tr> <tr> <td>NS125</td> <td>2.5</td> <td>8.6</td> <td>3.2</td> </tr> </tbody> </table> </div>	Type	A	B	C	NRS20, NRV20	0.65	0.7	2.0	NRH24	0.7	0.75	2.0	NR30, NRV30, NRH30	0.8	1.4	2.7	NR40, NRS40	1.2	1.6	3.7	NR50, NRS50	1.5	2.1	4.0	NR60, NRS60	1.6	3.1	5.7	NR80, NRS80	1.8	3.8	7.5	Type	A	B	C	NS101	2.5	5.6	3.2	NS125	2.5	8.6
Type	A	B	C																																									
NRS20, NRV20	0.65	0.7	2.0																																									
NRH24	0.7	0.75	2.0																																									
NR30, NRV30, NRH30	0.8	1.4	2.7																																									
NR40, NRS40	1.2	1.6	3.7																																									
NR50, NRS50	1.5	2.1	4.0																																									
NR60, NRS60	1.6	3.1	5.7																																									
NR80, NRS80	1.8	3.8	7.5																																									
Type	A	B	C																																									
NS101	2.5	5.6	3.2																																									
NS125	2.5	8.6	3.2																																									

9. Insulation resistance : between wires		
Specified Value	NR30/40/50/60/80, NRV20/30, NRH24/30, NRS20/40/50/60/80 Type	—
	NR10050 Type	
	NS101, NS125 Type	

10. Insulation resistance : between wire and core		
Specified Value	NR30/40/50/60/80, NRV20/30, NRH24/30, NRS20/40/50/60/80 Type	—
	NR10050 Type	
	NS101, NS125 Type	

▶ This catalog contains the typical specification only due to the limitation of space. When you consider the purchase of our products, please check our specification.  
For details of each product (characteristics graph, reliability information, precautions for use, and so on), see our Web site (<http://www.ty-top.com/>).



15. Resistance to soldering heat		
Specified Value	NR30/40/50/60/80, NRV20/30, NRH24/30, NRS20/40/50/60/80 Type	Inductance change : Within $\pm 10\%$ No significant abnormality in appearance.
	NR10050 Type	
	NS101, NS125 Type	
Test Methods and Remarks	NR30/40/50/60/80, NRV20/30, NRH24/30, NRS20/40/50/60/80 Type, NR10050 Type, NS101/125 Type : The test sample shall be exposed to reflow oven at $230\pm 5^{\circ}\text{C}$ for 40 seconds, with peak temperature at $260\pm 5^{\circ}\text{C}$ for 5 seconds, 2 times.  NR30/40/50/60/80, NRV20/30, NRH24/30, NRS20/40/50/60/80 Type, NS101/125 Type Test board material : Glass epoxy-resin Test board thickness : 1.0mm NR10050 Type Test board material : Glass epoxy-resin Test board thickness : 1.6mm Recovery : At least 2hrs of recovery under the standard condition after the test, followed by the measurement within 48hrs.	

16. Thermal shock																				
Specified Value	NR30/40/50/60/80, NRV20/30, NRH24/30, NRS20/40/50/60/80 Type	Inductance change : Within $\pm 10\%$ No significant abnormality in appearance.																		
	NR10050 Type																			
	NS101, NS125 Type																			
Test Methods and Remarks	NR30/40/50/60/80, NRV20/30, NRH24/30, NRS20/40/50/60/80 Type, NR10050 Type, NS101/125 Type : The test samples shall be soldered to the test board by the reflow. The test samples shall be placed at specified temperature for specified time by step 1 to step 4 as shown in below table in sequence. The temperature cycle shall be repeated 100 cycles. <table border="1" style="margin: 10px auto;"> <thead> <tr> <th colspan="3">Conditions of 1 cycle</th> </tr> <tr> <th>Step</th> <th>Temperature (<math>^{\circ}\text{C}</math>)</th> <th>Duration (min)</th> </tr> </thead> <tbody> <tr> <td>1</td> <td><math>-40\pm 3</math></td> <td><math>30\pm 3</math></td> </tr> <tr> <td>2</td> <td>Room temperature</td> <td>Within 3</td> </tr> <tr> <td>3</td> <td><math>+85\pm 2</math></td> <td><math>30\pm 3</math></td> </tr> <tr> <td>4</td> <td>Room temperature</td> <td>Within 3</td> </tr> </tbody> </table> Recovery : At least 2hrs of recovery under the standard condition after the test, followed by the measurement within 48hrs.		Conditions of 1 cycle			Step	Temperature ( $^{\circ}\text{C}$ )	Duration (min)	1	$-40\pm 3$	$30\pm 3$	2	Room temperature	Within 3	3	$+85\pm 2$	$30\pm 3$	4	Room temperature	Within 3
Conditions of 1 cycle																				
Step	Temperature ( $^{\circ}\text{C}$ )	Duration (min)																		
1	$-40\pm 3$	$30\pm 3$																		
2	Room temperature	Within 3																		
3	$+85\pm 2$	$30\pm 3$																		
4	Room temperature	Within 3																		

17. Damp heat								
Specified Value	NR30/40/50/60/80, NRV20/30, NRH24/30, NRS20/40/50/60/80 Type	Inductance change : Within $\pm 10\%$ No significant abnormality in appearance.						
	NR10050 Type		—					
	NS101, NS125 Type	Inductance change : Within $\pm 10\%$ No significant abnormality in appearance.						
Test Methods and Remarks	NR30/40/50/60/80, NRV20/30, NRH24/30, NRS20/40/50/60/80 Type, NS101/125 Type : The test samples shall be soldered to the test board by the reflow. The test samples shall be placed in thermostatic oven set at specified temperature and humidity as shown in below table. <table border="1" style="margin: 10px auto;"> <tbody> <tr> <td>Temperature</td> <td><math>60\pm 2^{\circ}\text{C}</math></td> </tr> <tr> <td>Humidity</td> <td>90~95%RH</td> </tr> <tr> <td>Time</td> <td>500+24/-0 hour</td> </tr> </tbody> </table> Recovery : At least 2hrs of recovery under the standard condition after the test, followed by the measurement within 48hrs.		Temperature	$60\pm 2^{\circ}\text{C}$	Humidity	90~95%RH	Time	500+24/-0 hour
Temperature	$60\pm 2^{\circ}\text{C}$							
Humidity	90~95%RH							
Time	500+24/-0 hour							

18. Loading under damp heat										
Specified Value	NR30/40/50/60/80, NRV20/30, NRH24/30, NRS20/40/50/60/80 Type	Inductance change : Within $\pm 10\%$ No significant abnormality in appearance.								
	NR10050 Type									
	NS101, NS125 Type									
Test Methods and Remarks	NR30/40/50/60/80, NRV20/30, NRH24/30, NRS20/40/50/60/80 Type, NR10050 Type, NS101/125 Type : The test samples shall be soldered to the test board by the reflow. The test samples shall be placed in thermostatic oven set at specified temperature and humidity and applied the rated current continuously as shown in below table. <table border="1" style="margin: 10px auto;"> <tbody> <tr> <td>Temperature</td> <td><math>60\pm 2^{\circ}\text{C}</math></td> </tr> <tr> <td>Humidity</td> <td>90~95%RH</td> </tr> <tr> <td>Applied current</td> <td>Rated current</td> </tr> <tr> <td>Time</td> <td>500+24/-0 hour</td> </tr> </tbody> </table> Recovery : At least 2hrs of recovery under the standard condition after the test, followed by the measurement within 48hrs.		Temperature	$60\pm 2^{\circ}\text{C}$	Humidity	90~95%RH	Applied current	Rated current	Time	500+24/-0 hour
Temperature	$60\pm 2^{\circ}\text{C}$									
Humidity	90~95%RH									
Applied current	Rated current									
Time	500+24/-0 hour									

▶ This catalog contains the typical specification only due to the limitation of space. When you consider the purchase of our products, please check our specification.  
 For details of each product (characteristics graph, reliability information, precautions for use, and so on), see our Web site (<http://www.ty-top.com/>).

19. Low temperature life test		
Specified Value	NR30/40/50/60/80, NRV20/30, NRH24/30, NRS20/40/50/60/80 Type	Inductance change : Within $\pm 10\%$ No significant abnormality in appearance.
	NR10050 Type	
	NS101, NS125 Type	
Test Methods and Remarks	NR30/40/50/60/80, NRV20/30, NRH24/30, NRS20/40/50/60/80 Type, NR10050 Type, NS101/125 Type : The test samples shall be soldered to the test board by the reflow. After that, the test samples shall be placed at test conditions as shown in below table.	
	Temperature	$-40 \pm 2^{\circ}\text{C}$
	Time	$500 + 24 / - 0$ hour
Recovery : At least 2hrs of recovery under the standard condition after the test, followed by the measurement within 48hrs.		
20. High temperature life test		
Specified Value	NR30/40/50/60/80, NRV20/30, NRH24/30, NRS20/40/50/60/80 Type	—
	NR10050 Type	—
	NS101, NS125 Type	—
Test Methods and Remarks	NR10050 Type :	
	Temperature	$105 \pm 3^{\circ}\text{C}$
	Time	$500 + 24 / - 0$ hour
Recovery : At least 2hrs of recovery under the standard condition after the test, followed by the measurement within 48hrs.		
21. Loading at high temperature life test		
Specified Value	NR30/40/50/60/80, NRV20/30, NRH24/30, NRS20/40/50/60/80 Type	Inductance change : Within $\pm 10\%$ No significant abnormality in appearance.
	NR10050 Type	—
	NS101, NS125 Type	Inductance change : Within $\pm 10\%$ No significant abnormality in appearance.
Test Methods and Remarks	NR30/40/50/60/80, NRV30, NRH24/30, NRS40/50/60/80 Type, NS12555, NS12565, NS12575 Type : The test samples shall be soldered to the test board by the reflow soldering.	
	Temperature	$85 \pm 2^{\circ}\text{C}$
	Applied current	Rated current
	Time	$500 + 24 / - 0$ hour
Recovery : At least 2hrs of recovery under the standard condition after the test, followed by the measurement within 48hrs.		
22. Standard condition		
Specified Value	NR30/40/50/60/80, NRV20/30, NRH24/30, NRS20/40/50/60/80 Type	Standard test condition : Unless otherwise specified, temperature is $20 \pm 15^{\circ}\text{C}$ and $65 \pm 20\%$ of relative humidity. When there is any question concerning measurement result: In order to provide correlation data, the test shall be condition of $20 \pm 2^{\circ}\text{C}$ of temperature, $65 \pm 5\%$ relative humidity. Inductance is in accordance with our measured value.
	NR10050 Type	
	NS101, NS125 Type	

# SMD POWER INDUCTORS (NR□, NS SERIES)

## PRECAUTIONS

### 1. Circuit Design

#### Precautions

#### ◆ Operating environment

1. The products described in this specification are intended for use in general electronic equipment, (office supply equipment, telecommunications systems, measuring equipment, and household equipment). They are not intended for use in mission-critical equipment or systems requiring special quality and high reliability (traffic systems, safety equipment, aerospace systems, nuclear control systems and medical equipment including life-support systems,) where product failure might result in loss of life, injury or damage. For such uses, contact TAIYO YUDEN Sales Department in advance.

### 2. PCB Design

#### Precautions

#### ◆ Land pattern design

1. Please refer to a recommended land pattern.
2. There is stress, which has been caused by distortion of a PCB, to the inductor.  
(NR30/40/50/60/80, NRV20/30, NRH24/30, NRS20/30/40/50/60/80 Type)
3. Please consider the arrangement of parts on a PCB. (NR30/40/50/60/80, NRV20/30, NRH24/30, NRS20/30/40/50/60/80 Type)

#### Technical considerations

#### ◆ Land pattern design

##### Surface Mounting

1. Mounting and soldering conditions should be checked beforehand.
2. Applicable soldering process to this products is reflow soldering only.
3. Please use the recommended land pattern shown as below. Electrical characteristics and the mounting ability of the product are being considered in the recommended land pattern. If a PCB is designed with other dimensions, defective soldering and stress to a product may occur due to misalignment. The performance of the product may not be brought out. If an adopted land pattern is different from the recommended land pattern, stress to the product will increase. It may cause cracks or defective electrical characteristics of the product. Please conduct validation completely before studying adoption of this product and please judge the pros and cons of adoption of this product with taking on responsibility.  
(NR30/40/50/60/80, NRV20/30, NRH24/30, NRS20/30/40/50/60/80 Type)
4. As coefficients of thermal expansion between an inductor and a PCB differs, cracks may occur on a ferrite core when thermal stress is applied to them after mounting an inductor. (Please refer to the drawings below.) Please conduct validation completely before studying adoption of this product and please judge the pros and cons of adoption of this product with taking on responsibility.  
(NR30/40/50/60/80, NRV20/30, NRH24/30, NRS20/30/40/50/60/80 Type)

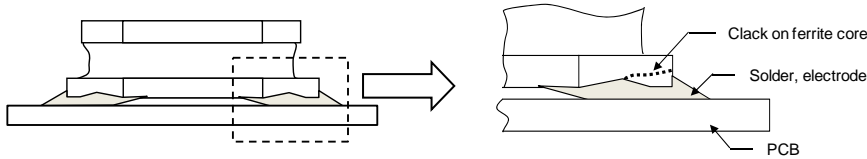

5. SMD inductors should be located to minimize any possible mechanical stresses from board warp or deflection. When splitting the PCB board after mounting inductors and other components, care is required so as not to give any stresses of deflection or twisting to the board.  
(NR30/40/50/60/80, NRV20/30, NRH24/30, NRS20/30/40/50/60/80 Type)

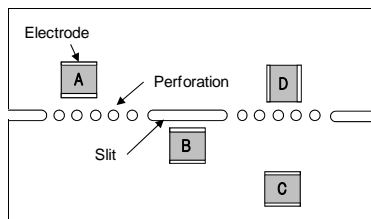

A product tends to undergo stress in order "A>C>B≡D".  
Please consider the layouts of a product to minimize any stresses.

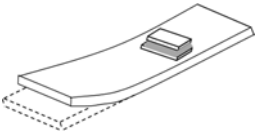
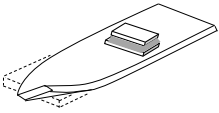
3. Considerations for automatic placement	
Precautions	<ul style="list-style-type: none"> <li>◆Adjustment of mounting machine               <ol style="list-style-type: none"> <li>1. Excessive impact load should not be imposed on the products when mounting onto the PC boards.</li> <li>2. Mounting and soldering conditions should be checked beforehand.</li> </ol> </li> </ul>
Technical considerations	<ul style="list-style-type: none"> <li>◆Adjustment of mounting machine               <ol style="list-style-type: none"> <li>1. When installing products, care should be taken not to apply distortion stress as it may deform the products.</li> <li>2. Stress may be applied to a product with a warp or a twist in handling of the product. Please conduct validation completely before studying adoption of this product and please judge the pros and cons of adoption of this product with taking on responsibility. (NR30/40/50/60/80, NRV20/30, NRH24/30, NRS20/30/40/50/60/80 Type)</li> </ol> </li> </ul> <div style="display: flex; justify-content: space-around; align-items: center;"> <div style="text-align: center;"> <p>&lt;Wrap&gt;</p>  </div> <div style="text-align: center;"> <p>&lt;Twist&gt;</p>  </div> </div>

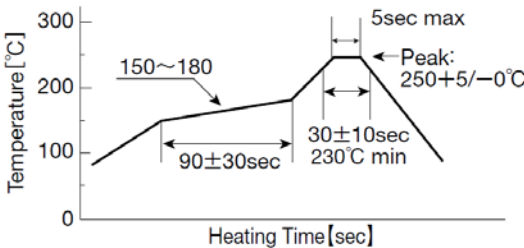
4. Soldering	
Precautions	<ul style="list-style-type: none"> <li>◆Reflow soldering               <ol style="list-style-type: none"> <li>1. Please contact any of our offices for a reflow soldering, and refer to the recommended condition specified.</li> <li>2. The product shall be used reflow soldering only.</li> <li>3. Please do not add any stress to a product until it returns in normal temperature after reflow soldering.</li> </ol> </li> <li>◆Lead free soldering               <ol style="list-style-type: none"> <li>1. When using products with lead free soldering, we request to use them after confirming adhesion, temperature of resistance to soldering heat, soldering etc sufficiently.</li> </ol> </li> <li>◆Recommended conditions for using a soldering iron (NR10050 Type)               <ul style="list-style-type: none"> <li>• Put the soldering iron on the land-pattern.</li> <li>• Soldering iron's temperature – Below 350°C</li> <li>• Duration – 3 seconds or less</li> <li>• The soldering iron should not directly touch the inductor.</li> </ul> </li> </ul>
Technical considerations	<ul style="list-style-type: none"> <li>◆Reflow soldering               <ol style="list-style-type: none"> <li>1. If products are used beyond the range of the recommended conditions, heat stresses may deform the products, and consequently degrade the reliability of the products.                   <ul style="list-style-type: none"> <li>•NR30/40/50/60/80, NRV20/30, NRH24/30, NRS20/40/50/60/80 Type, NR10050 Type, NS101/125 Type</li> </ul> </li> </ol> </li> </ul> <p>Recommended reflow condition (Pb free solder)</p> 

5. Cleaning	
Precautions	<ul style="list-style-type: none"> <li>◆Cleaning conditions               <ol style="list-style-type: none"> <li>1. Washing by supersonic waves shall be avoided.</li> </ol> </li> </ul>
Technical considerations	<ul style="list-style-type: none"> <li>◆Cleaning conditions               <ol style="list-style-type: none"> <li>1. If washed by supersonic waves, the products might be broken.</li> </ol> </li> </ul>

▶ This catalog contains the typical specification only due to the limitation of space. When you consider the purchase of our products, please check our specification. For details of each product (characteristics graph, reliability information, precautions for use, and so on), see our Web site (<http://www.ty-top.com/>)

6. Handling	
Precautions	<ul style="list-style-type: none"> <li>◆ Handling               <ol style="list-style-type: none"> <li>1. Keep the product away from all magnets and magnetic objects.</li> </ol> </li> <li>◆ Breakaway PC boards (splitting along perforations)               <ol style="list-style-type: none"> <li>1. When splitting the PC board after mounting product, care should be taken not to give any stresses of deflection or twisting to the board.</li> <li>2. Board separation should not be done manually, but by using the appropriate devices.</li> </ol> </li> <li>◆ Mechanical considerations               <ol style="list-style-type: none"> <li>1. Please do not give the product any excessive mechanical shocks.</li> <li>2. Please do not add any shock and power to a product in transportation.</li> </ol> </li> <li>◆ Pick-up pressure               <ol style="list-style-type: none"> <li>1. Please do not push to add any pressure to a winding part. Please do not give any shock and push into a ferrite core exposure part.</li> </ol> </li> <li>◆ Packing               <ol style="list-style-type: none"> <li>1. Please avoid accumulation of a packing box as much as possible.</li> </ol> </li> </ul>
Technical considerations	<ul style="list-style-type: none"> <li>◆ Handling               <ol style="list-style-type: none"> <li>1. There is a case that a characteristic varies with magnetic influence.</li> </ol> </li> <li>◆ Breakaway PC boards (splitting along perforations)               <ol style="list-style-type: none"> <li>1. The position of the product on PCBs shall be carefully considered to minimize the stress caused from splitting of the PCBs.</li> </ol> </li> <li>◆ Mechanical considerations               <ol style="list-style-type: none"> <li>1. There is a case to be damaged by a mechanical shock.</li> <li>2. There is a case to be broken by the handling in transportation.</li> </ol> </li> <li>◆ Pick-up pressure               <ol style="list-style-type: none"> <li>1. Damage and a characteristic can vary with an excessive shock or stress.</li> </ol> </li> <li>◆ Packing               <ol style="list-style-type: none"> <li>1. If packing boxes are accumulated, that could cause a deformation on packing tapes or a damage on the products.</li> </ol> </li> </ul>
7. Storage conditions	
Precautions	<ul style="list-style-type: none"> <li>◆ Storage               <ol style="list-style-type: none"> <li>1. To maintain the solderability of terminal electrodes and to keep the packing material in good condition, temperature and humidity in the storage area should be controlled.                   <ul style="list-style-type: none"> <li>▪ Recommended conditions                       <ul style="list-style-type: none"> <li>Ambient temperature : <math>-5\sim 40^{\circ}\text{C}</math></li> <li>Humidity : Below 70% RH</li> </ul> </li> <li>▪ The ambient temperature must be kept below <math>30^{\circ}\text{C}</math>. Even under ideal storage conditions, solderability of products electrodes may decrease as time passes.                       <ul style="list-style-type: none"> <li>For this reason, product should be used within 6 months from the time of delivery.</li> <li>In case of storage over 6 months, solderability shall be checked before actual usage.</li> </ul> </li> </ul> </li> </ol> </li> </ul>
Technical considerations	<ul style="list-style-type: none"> <li>◆ Storage               <ol style="list-style-type: none"> <li>1. Under a high temperature and humidity environment, problems such as reduced solderability caused by oxidation of terminal electrodes and deterioration of taping/packaging materials may take place.</li> </ol> </li> </ul>





## Looking for pricing, stock, or lifecycle information?

Click below to explore more details on WIN SOURCE:

 [View NR6045T1R3N on WIN SOURCE](#)

 [Taiyo Yuden Information](#)

## Optimize Your Supply Chain with WIN SOURCE Solutions

-  Global Sourcing Solution
-  Obsolete Management
-  Cost Control Management
-  Shortage Management
-  Alternative Solution
-  Excess Inventory Management