



**THE DATASHEET OF  
AT-910(40)**



# Stripline Mounting Fixed Attenuators (DC to 8 GHz)

## AT-900 Series

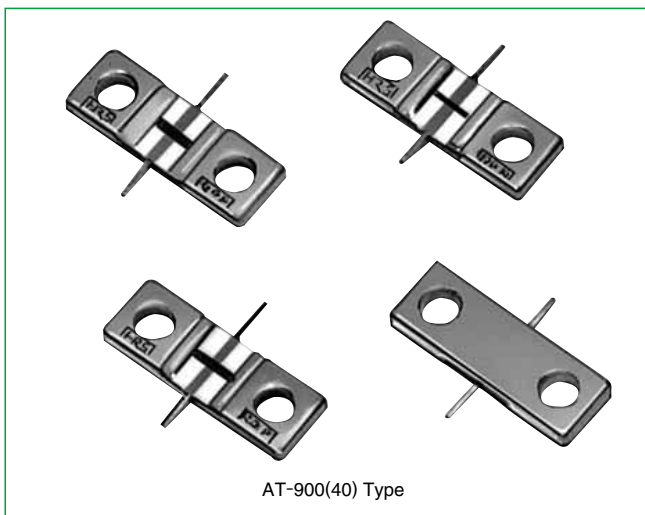

### ■Features

#### 1. Frequency Range from DC to 8 GHz

Although these attenuators are of the surface mount type, they offer superior high frequency characteristics from DC to 8 GHz.

#### 2. Abundant Variations of Attenuators

Attenuation amounts are available in 11 types from 0 to 10 dB in 1 dB steps.

### ■Product Specifications

Ratings	Frequency Range (Note) Characteristic impedance Maximum Input Power (Note)	DC to 8.0 GHz 50 ohms 1 W	Operating temperature range Operating relative humidity	-10°C to +65°C 95% Max.
---------	--	---------------------------------	--	----------------------------

Note: The frequency range and the maximum input power will differ depending on the products.

Item	Standard	Conditions
1. Vibration	No electrical discontinuity of 1 $\mu$ s or more	Frequency of 10 to 2000 Hz, overall amplitude of 1.52 mm, acceleration of 98 m/s <sup>2</sup> for 2 hours in each of 3 directions
2. Shock	No damage, cracks, or parts dislocation	Acceleration of 490 m/s <sup>2</sup> , sine half-wave waveform, 3 cycles in each of the 3 axis
3. Temperature cycle	No damage, cracks, or parts dislocation	Temperature: -55°C → +15°C to +35°C → +85°C → +15°C to +35°C Time: 30 → 15 max. → 30 → 15 max. (Minutes) 5 cycles

●The test method conforms to MIL-STD-202.

### ■Materials

Part	Material	Finish
Connector Body	Brass	Nickel plating
Attenuation element	Metal film	—
Tabs	Copper	Solder plating

### ■Ordering Information

**AT - 9 01 (40)**  

①
②
③
④

<p>① AT: Indicates a fixed attenuator</p>	<p>③ Attenuation</p> <p>01 : 1dB</p> <p>06 : 6dB</p> <p>00-(0) : 0dB (Through)</p> <p>00-(1.5) : 1.5dB</p>
<p>② Indicates the Series Name: AT-900 Series</p>	<p>④ (40): RoHS Compliant</p>

## AT-900 Series Stripline Mounting Fixed Attenuators (DC to 8 GHz)

### Specifications

Model No.	Attenuation (dB)		V.S.W.R. (Max) DC~8GHz	Power (W)	Surface Temperature at Maximum Load (°C Max)	Weight (g)	RoHS
	DC~4GHz	4~8GHz					
AT-900-(0)(40)	0 <sup>+0.5</sup> <sub>0</sub>	0 <sup>+0.7</sup> <sub>0</sub>	1.35	1	+85	1	YES
AT-901(40)	1±0.5	1±0.7	1.35	1	+85	1	
AT-902(40)	2±0.5	2±0.7	1.35	1	+85	1	
AT-903(40)	3±0.5	3±0.7	1.35	1	+85	1	
AT-904(40)	4±0.5	4±0.7	1.35	1	+85	1	
AT-905(40)	5±0.5	5±0.7	1.35	1	+85	1	
AT-906(40)	6±0.5	6±0.7	1.35	1	+85	1	
AT-907(40)	7±0.5	7±0.7	1.35	1	+85	1	
AT-908(40)	8±0.5	8±0.7	1.35	1	+85	1	
AT-909(40)	9±0.5	9±0.7	1.35	1	+85	1	
AT-910(40)	10±0.5	10±0.7	1.35	1	+85	1	

### External Dimensions

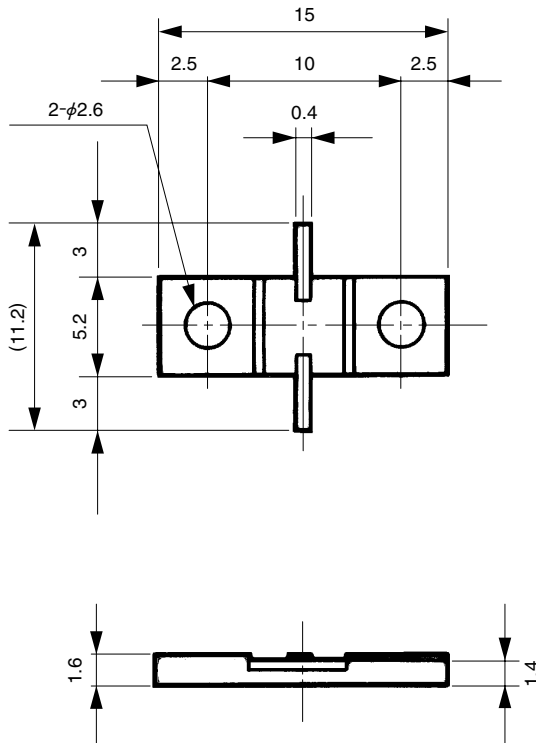

AT-900 Type

## Typical Data

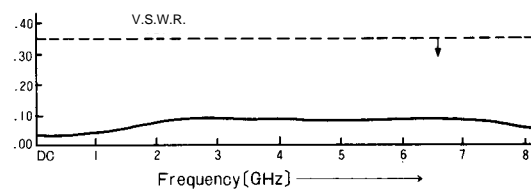
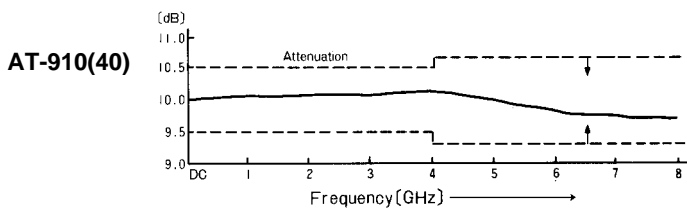
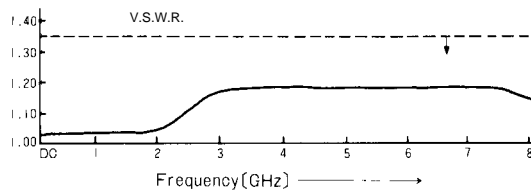
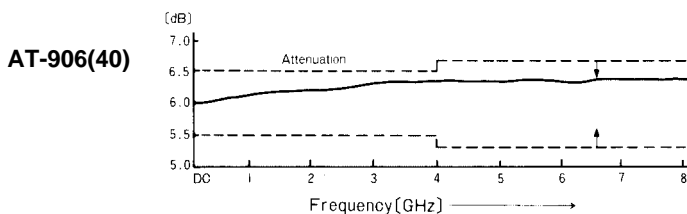
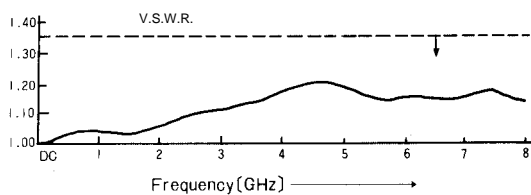
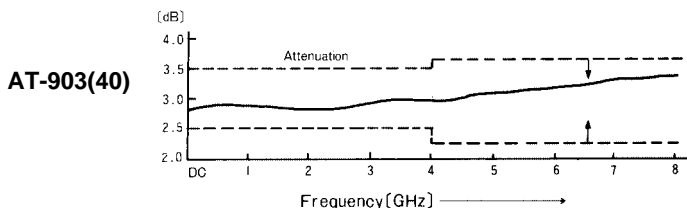
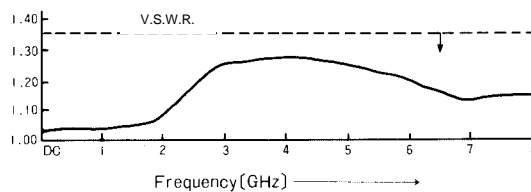
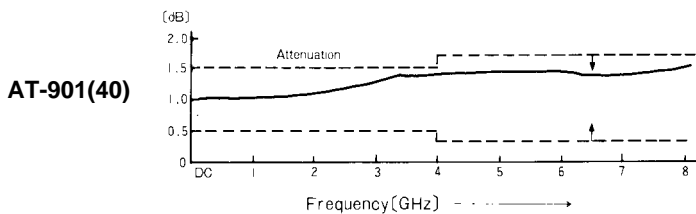

## Mounting Method

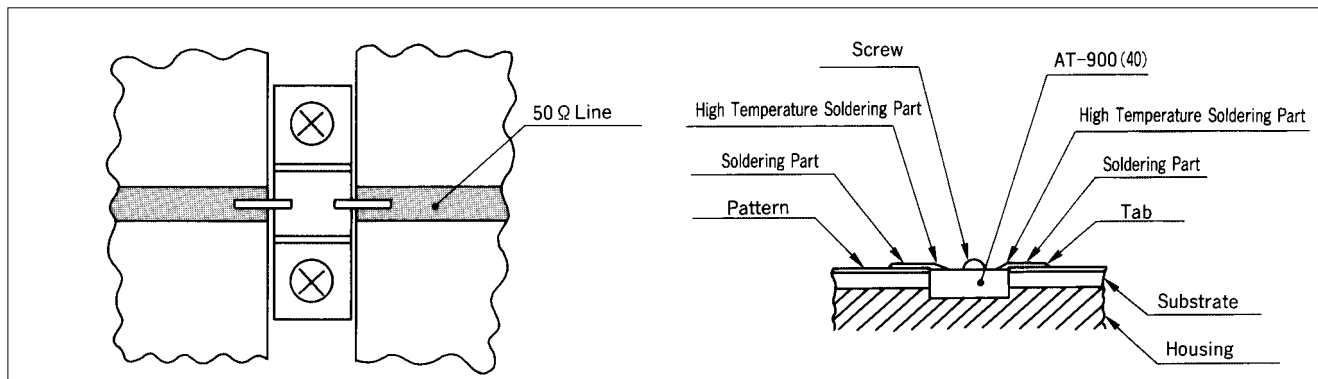

### AT-900(40) Type









- Make the AT-900(40) tab height from the housing and the thickness of the microstrip board the same amount.
- The tabs are attached with high temperature solder (having a melting point of 280°C). The soldering temperature to the microstrip board must be less than this.

## Looking for pricing, stock, or lifecycle information?

Click below to explore more details on WIN SOURCE:

-  [View AT-910\(40\) on WIN SOURCE](#)
-  [Hirose Electric Co Ltd Information](#)

## Optimize Your Supply Chain with WIN SOURCE Solutions

-  Global Sourcing Solution
-  Obsolete Management
-  Cost Control Management
-  Shortage Management
-  Alternative Solution
-  Excess Inventory Management