

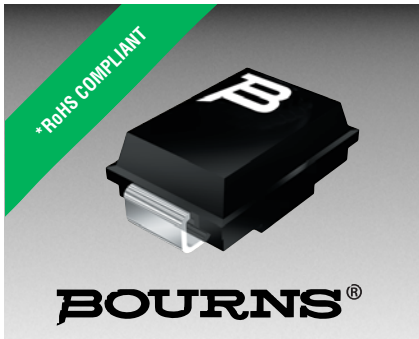

**THE DATASHEET OF
TISP4350J3BJR-S**





TISP4070J3BJ THRU TISP4395J3BJ

BIDIRECTIONAL THYRISTOR OVERVOLTAGE PROTECTORS

TISP4xxxJ3BJ Overvoltage Protector Series

- Ion-Implanted Breakdown Region**
- Precise and Stable Voltage
 - Low Voltage Overshoot Under Surge

- Designed for Transformer Center Tap (Ground Return) Overvoltage Protection**
- Enables GR-1089-CORE Compliance
 - High Holding Current Allows Protection of Data Lines with d.c. Power Feed

Can be Used to Protect Rugged Modems Designed for Exposed Applications Exceeding TIA-968-A

Device Name	V _{DRM} V	V _(BO) V
TISP4070J3BJ	58	70
TISP4080J3BJ	65	80
TISP4095J3BJ	75	95
TISP4115J3BJ	90	115
TISP4125J3BJ	100	125
TISP4145J3BJ	120	145
TISP4165J3BJ	135	165
TISP4180J3BJ	145	180
TISP4200J3BJ	155	200
TISP4219J3BJ	180	219
TISP4250J3BJ	190	250
TISP4290J3BJ	220	290
TISP4350J3BJ	275	350
TISP4395J3BJ	320	395

 UL Recognized Component

SMB Package (Top View)

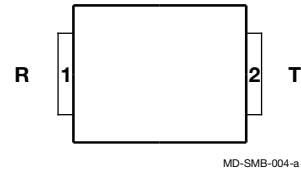

Device Symbol



Rated for International Surge Wave Shapes

Wave Shape	Standard	I _{PPSM} A
2/10	GR-1089-CORE	1000
8/20	IEC 61000-4-5	800
10/160	TIA-968-A	400
10/700	ITU-T K.20/21/45	350
10/560	TIA-968-A	250
10/1000	GR-1089-CORE	200

Description

The range of TISP4xxxJ3BJ devices are designed to limit overvoltages on telecom lines. The TISP4xxxJ3BJ is primarily designed to address GR-1089-CORE compliance on data transmission lines with d.c. power feeding. When overvoltage protection is applied to transformer coupled lines from the transformer center tap to ground, the total ground return current can be 200 A, 10/1000 and 1000 A, 2/10. The high 150 mA holding current is set above common d.c. feed system levels to allow the TISP4xxxJ3BJ to reset following a disturbance.

These devices allow signal voltages, without clipping, up to the maximum off-state voltage value, V_{DRM}, see Figure 1. Voltages above V_{DRM} are limited and will not exceed the breakover voltage, V_(BO), level. If sufficient current flows due to the overvoltage, the device switches into a low voltage on-state condition, which diverts the current from the overvoltage through the device. When the diverted current falls below the holding current, I_H, level the devices switches off and restores normal system operation.

How to Order

Device	Package	Carrier	Order As	Marking Code	Std. Qty.
TISP4xxxJ3BJ	SMB (DO-214AA)	Embossed Tape Reeled	TISP4xxxJ3BJR-S	4xxxJ3	3000

Insert xxx value corresponding to device name.

*RoHS Directive 2002/95/EC Jan. 27, 2003 including annex and RoHS Recast 2011/65/EU June 8, 2011.

JULY 2003 - REVISED NOVEMBER 2013

Specifications are subject to change without notice.

The device characteristics and parameters in this data sheet can and do vary in different applications and actual device performance may vary over time. Users should verify actual device performance in their specific applications.

TISP4xxxJ3BJ Overvoltage Protector Series

BOURNS®

Absolute Maximum Ratings, $T_A = 25\text{ °C}$ (Unless Otherwise Noted)

Rating	Symbol	Value	Unit
Repetitive peak off-state voltage	'4070J3BJ	±58	V
	'4080J3BJ	±65	
	'4095J3BJ	±75	
	'4115J3BJ	±90	
	'4125J3BJ	±100	
	'4145J3BJ	±120	
	'4165J3BJ	±135	
	'4180J3BJ	±145	
	'4200J3BJ	±155	
	'4219J3BJ	±180	
	'4250J3BJ	±190	
	'4290J3BJ	±220	
	'4350J3BJ	±275	
'4395J3BJ	±320		
Non-repetitive peak impulse current (see Notes 1 and 2) 2/10 μs (GR-1089-CORE, 2/10 μs voltage wave shape) 8/20 μs (IEC 61000-4-5, combination wave generator, 1.2/50 μs voltage wave shape) 10/160 μs (TIA-968-A, 10/160 μs voltage wave shape) 4/250 μs (ITU-T K.20/21, 10/700 μs voltage waveshape, simultaneous) 5/310 μs (ITU-T K.20/21, 10/700 μs voltage wave shape, single) 5/320 μs (TIA-968-A, 9/720 μs voltage waveshape, single) 10/560 μs (TIA-968-A, 10/560 μs voltage wave shape) 10/1000 μs (GR-1089-CORE, 10/1000 μs voltage wave shape)	I_{PPSM}	±1000 ±800 ±400 ±370 ±350 ±350 ±250 ±200	A
Non-repetitive peak on-state current (see Notes 1 and 2) 20 ms, 50 Hz (full sine wave)	I_{TSM}	50	A
Initial rate of rise of on-state current. Linear current ramp. Maximum ramp value < 50 A	di_T/dt	800	A/ μs
Junction temperature	T_J	-40 to +150	°C
Storage temperature range	T_{stg}	-65 to +150	°C

NOTES: 1. Initially the device must be in thermal equilibrium with $T_J = 25\text{ °C}$.

2. These non-repetitive rated currents are peak values of either polarity. The surge may be repeated after the device returns to its initial conditions.

Electrical Characteristics, $T_A = 25\text{ °C}$ (Unless Otherwise Noted)

Parameter	Test Conditions	Min	Typ	Max	Unit
I_{DRM} Repetitive peak off-state current	$V_D = V_{DRM}$ $T_A = 25\text{ °C}$ $T_A = 85\text{ °C}$			±5 ±10	μA
$V_{(BO)}$ AC Breakover voltage	$dv/dt = \pm 250\text{ V/ms}$, $R_{SOURCE} = 300\ \Omega$			±70 ±80 ±95 ±115 ±125 ±145 ±165 ±180 ±200 ±219 ±250 ±290 ±350 ±395	V

JULY 2003 - REVISED NOVEMBER 2013

Specifications are subject to change without notice.

The device characteristics and parameters in this data sheet can and do vary in different applications and actual device performance may vary over time.

Users should verify actual device performance in their specific applications.

TISP4xxxJ3BJ Overvoltage Protector Series

BOURNS®

Electrical Characteristics, $T_A = 25^\circ\text{C}$ (Unless Otherwise Noted)

Parameter	Test Conditions	Min	Typ	Max	Unit	
$V_{(BO)}$ Ramp breakover voltage	dv/dt $\leq \pm 1000$ V/ μ s, Linear voltage ramp, Maximum ramp value = ± 500 V di/dt = ± 20 A/ μ s, Linear current ramp, Maximum ramp value = ± 10 A			'4070J3BJ	± 77	
				'4080J3BJ	± 88	
				'4095J3BJ	± 104	
				'4115J3BJ	± 125	
				'4125J3BJ	± 135	
				'4145J3BJ	± 156	
				'4165J3BJ	± 177	
				'4180J3BJ	± 192	
				'4200J3BJ	± 212	
				'4219J3BJ	± 231	
				'4250J3BJ	± 263	
				'4290J3BJ	± 303	
				'4350J3BJ	± 364	
'4395J3BJ	± 409					
$I_{(BO)}$ Breakover current	dv/dt = ± 250 V/ms, $R_{SOURCE} = 300 \Omega$			'4070J3BJ thru '4115J3BJ '4125J3BJ thru '4219J3BJ '4250J3BJ thru '4395J3BJ	± 900 ± 800 ± 600	mA
I_H Holding current	$I_T = \pm 5$ A, di/dt = ± 30 mA/ms	± 150			± 600	mA
dv/dt Critical rate of rise of off-state voltage	Linear voltage ramp Maximum ramp value $< 0.85V_{DRM}$	± 5				kV/ μ s
I_D Off-state current	$V_D = \pm 50$ V $T_A = 85^\circ\text{C}$				± 10	μ A
C_O Off-state capacitance	f = 1 MHz, $V_d = 1$ V rms, $V_D = 0$	'4070J3BJ thru '4115J3BJ	195	235	pF	
		'4125J3BJ thru '4219J3BJ	120	145		
		'4250J3BJ thru '4395J3BJ	105	125		
	f = 1 MHz, $V_d = 1$ V rms, $V_D = -1$ V	'4070J3BJ thru '4115J3BJ	180	215		
		'4125J3BJ thru '4219J3BJ	110	132		
		'4250J3BJ thru '4395J3BJ	95	115		
	f = 1 MHz, $V_d = 1$ V rms, $V_D = -2$ V	'4070J3BJ thru '4115J3BJ	165	200		
		'4125J3BJ thru '4219J3BJ	100	120		
		'4250J3BJ thru '4395J3BJ	90	105		
	f = 1 MHz, $V_d = 1$ V rms, $V_D = -50$ V	'4070J3BJ thru '4115J3BJ	85	100		
		'4125J3BJ thru '4219J3BJ	50	60		
		'4250J3BJ thru '4395J3BJ	42	50		
f = 1 MHz, $V_d = 1$ V rms, $V_D = -100$ V (see Note 3)	'4125J3BJ thru '4219J3BJ	40	50			
	'4250J3BJ thru '4395J3BJ	35	40			

NOTE: 3. To avoid possible clipping, the TISP4125J3BJ is tested with $V_D = -98$ V.

Thermal Characteristics

Parameter	Test Conditions	Min	Typ	Max	Unit
$R_{\theta JA}$ Junction to ambient thermal resistance	EIA/JESD51-3 PCB, $I_T = I_{TSM(1000)}$ (see Note 4)			90	$^\circ\text{C/W}$

NOTE: 4. EIA/JESD51-2 environment and PCB has standard footprint dimensions connected with 5 A rated printed wiring track widths.

JULY 2003 - REVISED NOVEMBER 2013

Specifications are subject to change without notice.

The device characteristics and parameters in this data sheet can and do vary in different applications and actual device performance may vary over time.

Users should verify actual device performance in their specific applications.

Parameter Measurement Information

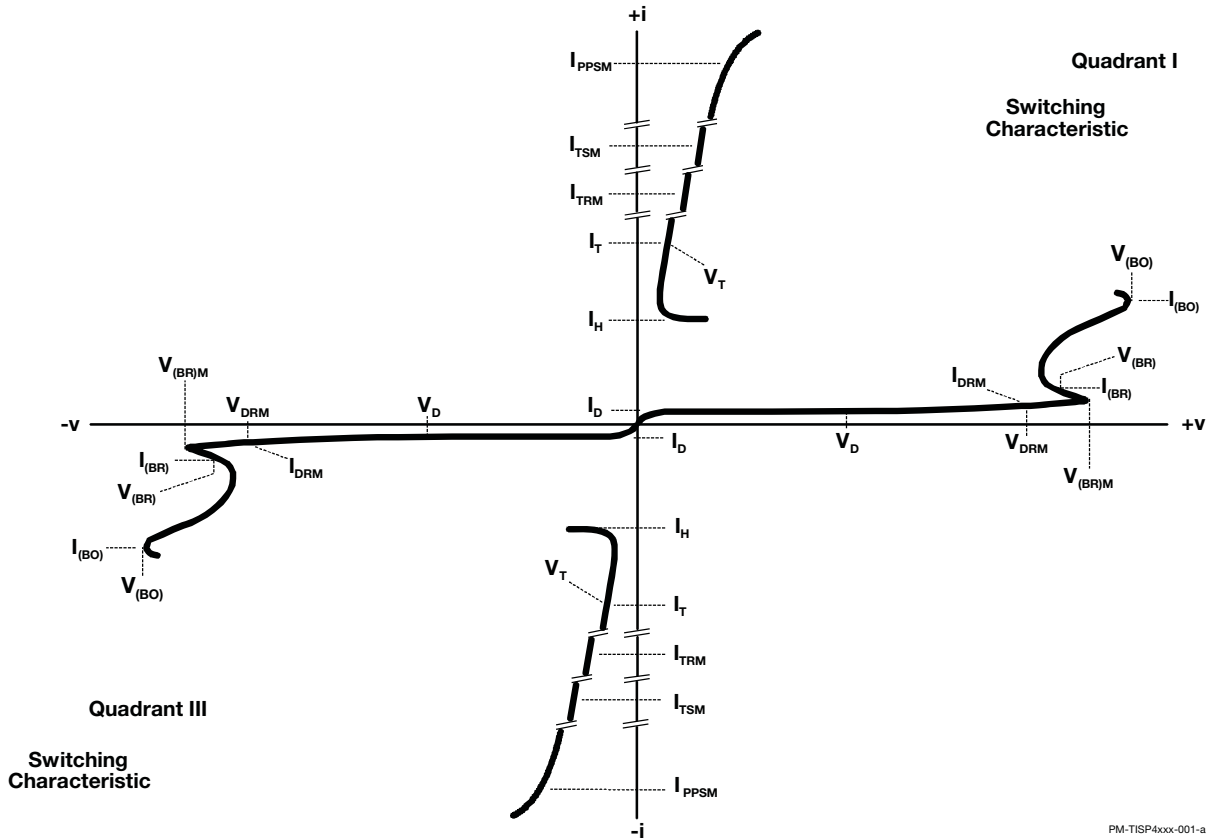

PM-TISP4xxx-001-a

Figure 1. Voltage-Current Characteristic for T and R Terminals
All Measurements are Referenced to the R Terminal

Typical Characteristics

**OFF-STATE CURRENT
VS
JUNCTION TEMPERATURE**

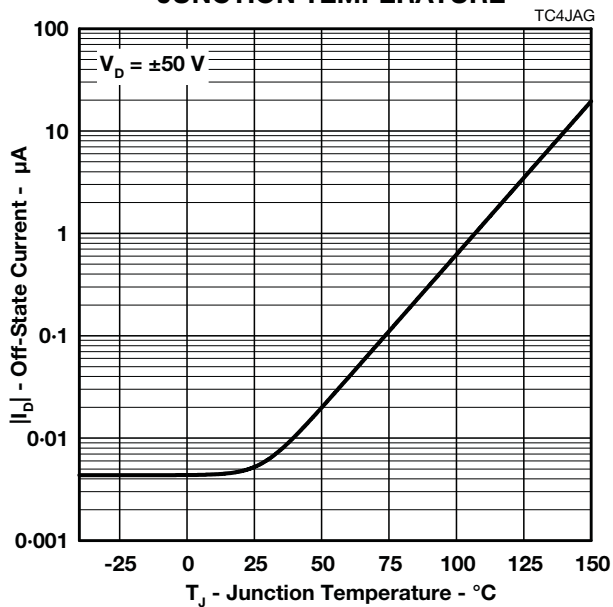

Figure 2.

**NORMALIZED BREAKOVER VOLTAGE
VS
JUNCTION TEMPERATURE**

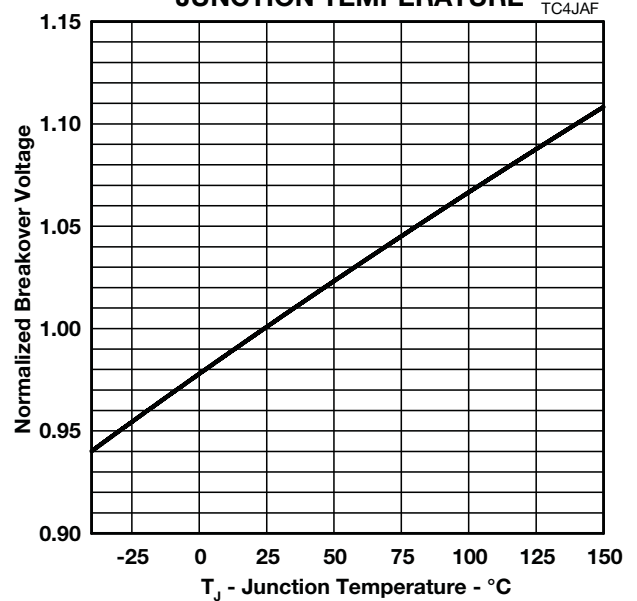

Figure 3.

**NORMALIZED HOLDING CURRENT
VS
JUNCTION TEMPERATURE**

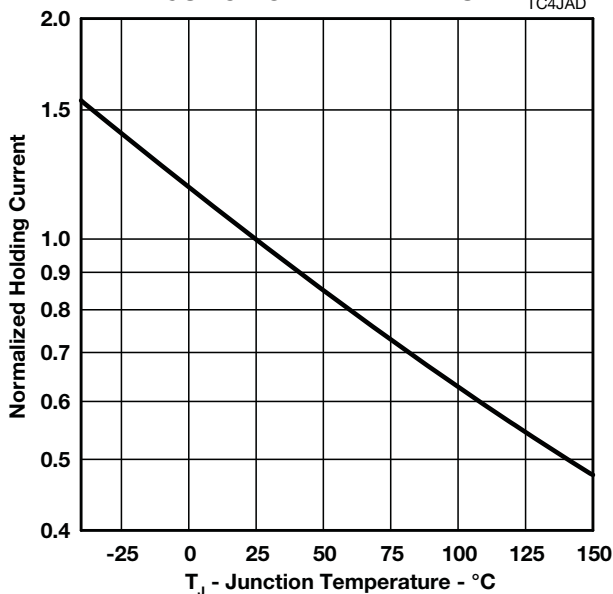

Figure 4.

**NORMALIZED CAPACITANCE
VS
OFF-STATE VOLTAGE**

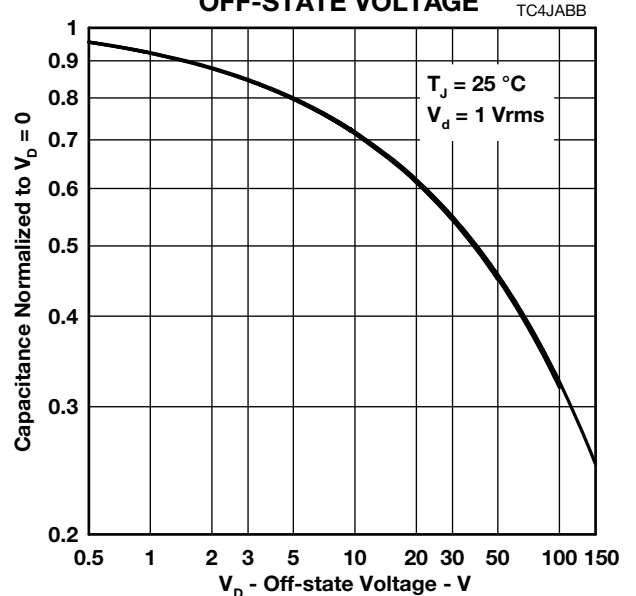

Figure 5.

JULY 2003 - REVISED NOVEMBER 2013

Specifications are subject to change without notice.

The device characteristics and parameters in this data sheet can and do vary in different applications and actual device performance may vary over time.

Users should verify actual device performance in their specific applications.

Rating and Thermal Characteristics

NON-REPETITIVE PEAK ON-STATE CURRENT VS CURRENT DURATION

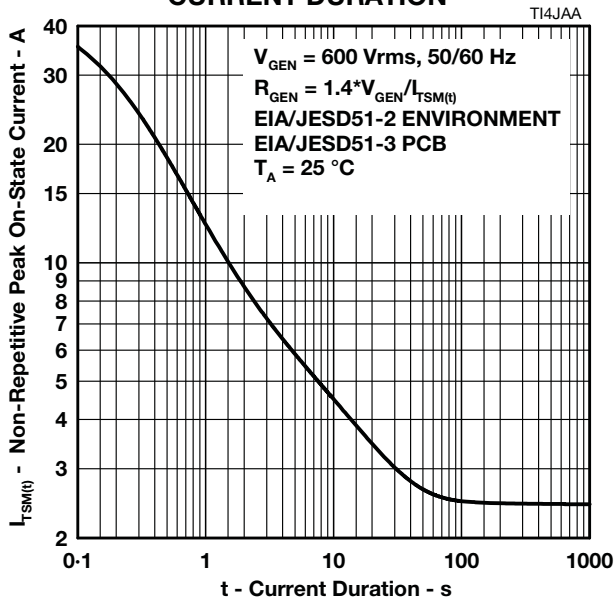

Figure 6.

V_{DRM} DERATING FACTOR VS MINIMUM AMBIENT TEMPERATURE

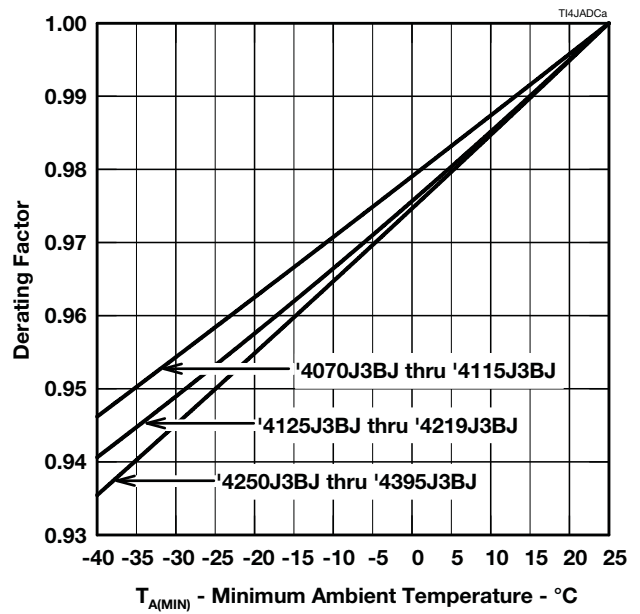

Figure 7.

Applications Information

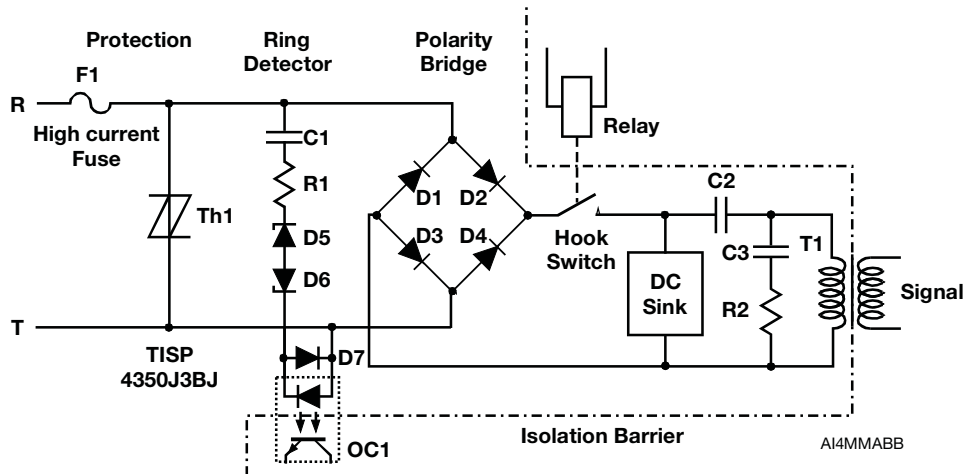

Figure 8. Typical Application Circuit

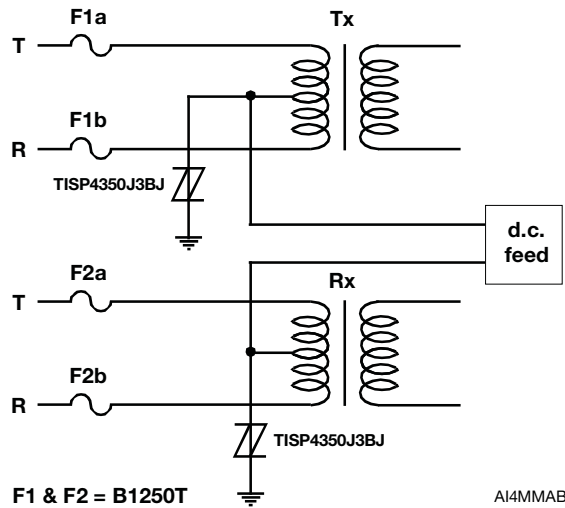

Figure 9. Typical Application Circuit

"TISP" is a registered trademark of Bourns Ltd., a Bourns Company, in the United States and other countries, except that "TISP" is a registered trademark of Bourns, Inc. in China. "Bourns" is a registered trademark of Bourns, Inc. in the U.S. and other countries.

JULY 2003 - REVISED NOVEMBER 2013



Specifications are subject to change without notice.

The device characteristics and parameters in this data sheet can and do vary in different applications and actual device performance may vary over time.

Users should verify actual device performance in their specific applications.

Looking for pricing, stock, or lifecycle information?

Click below to explore more details on WIN SOURCE:

-  [View TISP4350J3BJR-S on WIN SOURCE](#)
-  [Bourns Inc. Information](#)

Optimize Your Supply Chain with WIN SOURCE Solutions

-  Global Sourcing Solution
-  Obsolete Management
-  Cost Control Management
-  Shortage Management
-  Alternative Solution
-  Excess Inventory Management