

# TB6643KQ

## Full-Bridge DC Motor Driver IC

The TB6643KQ is a full-bridge DC motor driver IC employing the MOS process for output power transistors.

The low ON-resistance MOS process and PWM control enables driving DC motors with high thermal efficiency.

Four operating modes are selectable via IN1 and IN2: clockwise (CW), counterclockwise (CCW), Short Brake and Stop.

### Features

- Power supply voltage: 50 V (max)
- Output current: 4.5 A (max)
- Output ON-resistance: 0.55  $\Omega$  (typ.)
- PWM control
- CW/CCW/Short Brake/Stop modes
- Overcurrent shutdown circuit (ISD)
- Overvoltage shutdown circuit (VSD)
- Thermal shutdown circuit (TSD)
- Undervoltage lockout circuit (UVLO)
- Dead time for preventing shoot-through current

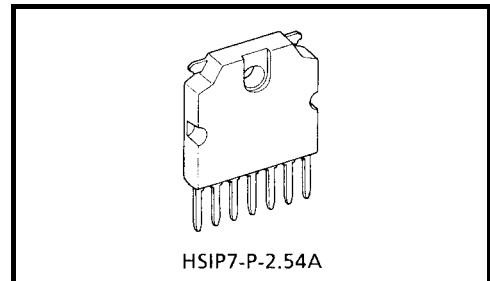

Weight: 2.2 g (typ.)

Note: The following conditions apply to solderability:

About solderability, following conditions were confirmed

- (1) Use of Sn-37Pb solder Bath
  - solder bath temperature: 230°C
  - dipping time: 5 seconds
  - the number of times: once
  - use of R-type flux
- (2) Use of Sn-3.0Ag-0.5Cu solder Bath
  - solder bath temperature: 245°C
  - dipping time: 5 seconds
  - the number of times: once
  - use of R-type flux

**Block Diagram (application circuit example)**

The application circuits shown in this document are provided for reference purposes only. Thorough evaluation is required, especially at the mass production design stage.

Toshiba does not grant any license to any industrial property rights by providing these examples of application circuits.

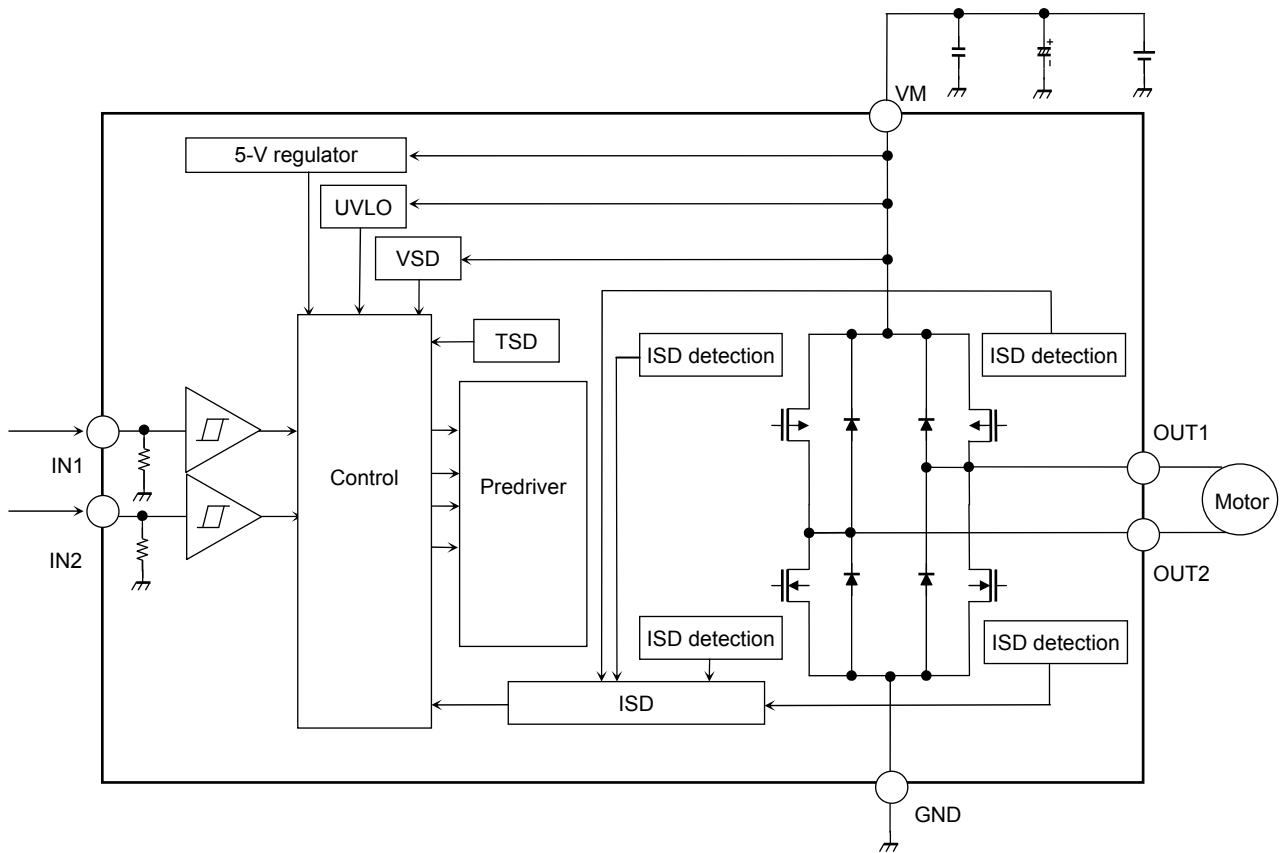

**Pin Functions**

Pin No.	Pin Name	Functional Description
1	IN1	Control signal input pin 1
2	IN2	Control signal input pin 2
3	OUT1	Output pin 1
4	GND	Ground pin
5	OUT2	Output pin 2
6	N.C.	No-connect
7	VM	Power supply voltage pin

## Absolute Maximum Ratings (Note) (Ta = 25°C)

Characteristics	Symbol	Rating	Unit
Power supply voltage	VM	50	V
Output voltage	VO	50	V
Output current 1	IO peak1	4.5 (Note 1)	A
Output current 2	IO peak2	4.0 (Note 2)	A
Input voltage	VIN	- 0.3 to 5.5	V
Power dissipation	PD	1.25 (Note 3)	W
Operating temperature	Topr	- 40 to 85	°C
Storage temperature	Tstg	- 55 to 150	°C

Note: The absolute maximum ratings of a semiconductor device are a set of ratings that must not be exceeded, even for a moment. Do not exceed any of these ratings.

Exceeding the rating (s) may cause the device breakdown, damage or deterioration, and may result injury by explosion or combustion.

Please use the TB6643KQ within the specified operating ranges.

Note 1: The absolute maximum output current rating of 4.5 A must be kept for OUT1 and OUT2 when  $VM \leq 36$  V.

Note 2: The absolute maximum output current rating of 4.0 A must be kept for OUT1 and OUT2 when  $VM > 36$  V.

Note 3: No heatsink

## Operating Ranges

Characteristics	Symbol	Rating	Unit
Power supply voltage	VMopr	10 to 45	V
PWM Frequency	fPWM	Up to 100	kHz
Output Current	IO (Ave.)	Up to 1.5 (Note 1) (given as a guide)	A

Note 1: Ta = 25°C, the TB6643KQ is mounted on the PCB (70 × 50 × 1.6 (mm), double-sided, Cu thickness: 50 μm, Cu dimension: 67%) with no heatsink.

\*: The average output current shall be increased or decreased depending on usage conditions such as ambient temperature, a presence/absence of a heatsink and IC mounting method.  
Please use the average output current so that the junction temperature of 150°C (Tj) and the absolute maximum output current rating of 4.0 A, 4.5A are not exceeded.

\*\* : Connecting the metal plate on the rear surface of the TB6643KQ to a heatsink allows for improvement of the power dissipation capability of the TB6643KQ. Please consider heat dissipation efficiency when designing the board layout.  
Moreover, this metal plate is electrically connected to the rear surface of the TB6643KQ; therefore, it must always be insulated or shorted to ground.

**Electrical Characteristics (unless otherwise specified, Ta = 25°C, VM = 24 V)**

Characteristics		Symbol	Test Condition	Min	Typ.	Max	Unit
Power supply current		I <sub>CC1</sub>	Stop mode	—	2.5	8	mA
		I <sub>CC2</sub>	CW/CCW mode	—	2.5	8	
		I <sub>CC3</sub>	Short Brake mode	—	2.5	8	
Control circuit IN1 pin, IN2 pin	Input voltage	V <sub>INH</sub>		2	—	5.5	V
		V <sub>INL</sub>		0	—	0.8	
	Hysteresis voltage	V <sub>IN (HYS)</sub>		—	0.4	—	μA
	Input current	I <sub>INH</sub>	V <sub>IN</sub> = 5 V	—	27	45	
I <sub>INL</sub>		V <sub>IN</sub> = 0 V	—	—	5		
PWM frequency		f <sub>PWM</sub>	Duty: 50 %	—	100	—	kHz
PWM minimum pulse width		f <sub>PWM (TW)</sub>	(value given as a guide)	1	—	—	μs
Output ON-resistance		R <sub>ON (U + L)</sub>	I <sub>O</sub> = 3 A	—	0.55	0.9	Ω
Output leakage current		I <sub>L (U)</sub>	V <sub>M</sub> = 50 V, V <sub>OUT</sub> = 0 V	- 2	—	—	μA
		I <sub>L (L)</sub>	V <sub>M</sub> = V <sub>OUT</sub> = 50 V	—	—	2	
Diode forward voltage		V <sub>F (U)</sub>	I <sub>O</sub> = 3 A	—	1.3	1.7	V
		V <sub>F (L)</sub>	I <sub>O</sub> = -3 A	—	1.3	1.7	

**Thermal Performance Characteristics**

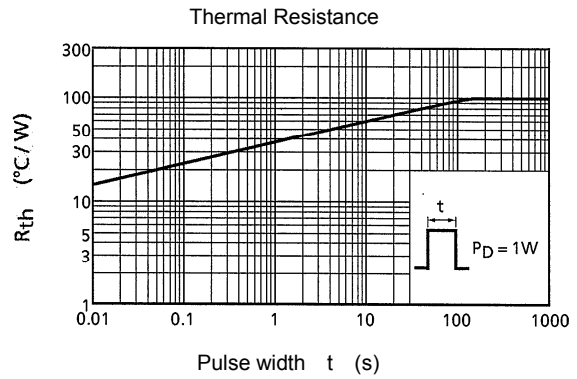
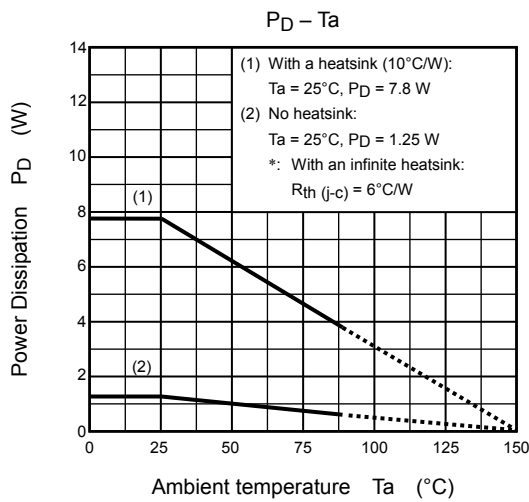

**I/O Equivalent Circuits**

The equivalent circuit diagrams may be simplified or some parts of them may be omitted for explanatory purposes.

Pin No.	I/O Signal	I/O Internal Circuit
IN1 (1) IN2 (2)	Digital input L: 0.8 V (max) H: 2 V (min)	
OUT1 (3) OUT2 (5) GND (4) VM (7)	Operating supply voltage range VM = 10 to 45 V	

## Functional Description

The equivalent circuit diagrams may be simplified or some parts of them may be omitted for explanatory purposes.

Timing charts may be simplified for explanatory purposes.

### 1. I/O Function Table

Input		Output		
IN1	IN2	OUT1	OUT2	Mode
H	H	L	L	Short Brake
L	H	L	H	CW/CCW
H	L	H	L	CCW/CW
L	L	OFF (Hi-Z)		Stop (caused by a release of TSD/ISD)

### 2. Undervoltage Lockout Circuit (UVLO)

The TB6643KQ incorporates an undervoltage lockout circuit. If the power supply voltage drops under 8 V (typ.), all the output transistors are turned off (Hi-Z).

The UVLO circuit has a hysteresis of 0.7 V (typ.); thus the TB6643KQ recovers at 8.7 V (typ.).

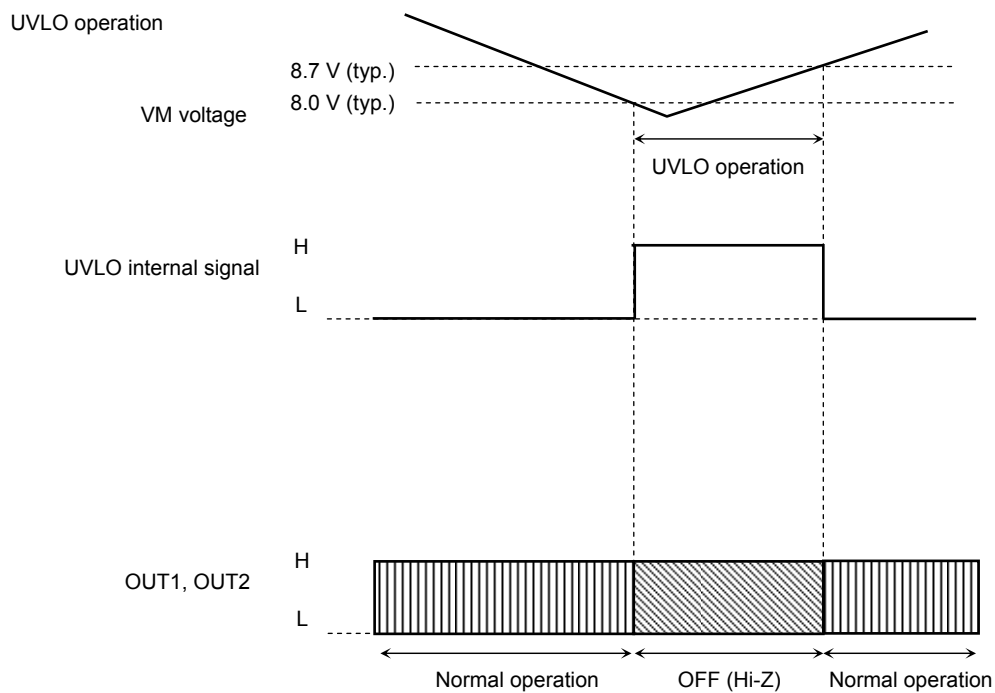

**3. Overvoltage Shutdown Circuit (VSD)**

The TB6643KQ incorporates an overvoltage shutdown circuit. When the power supply voltage exceeds 53 V (typ.), all the output transistors are turned off (Hi-Z). The VSD circuit has a hysteresis of 3 V (typ.); thus the TB6643KQ resumes the normal operation at 50 V (typ.).

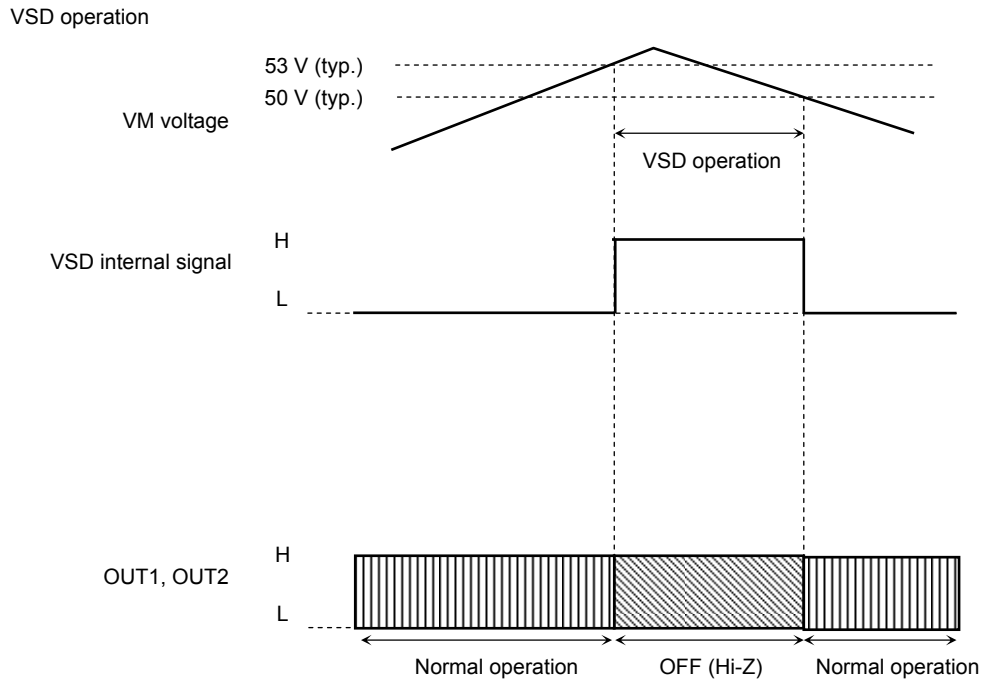

Note: The VSD circuit is activated if the absolute maximum voltage rating is violated. Note that the circuit is provided as an auxiliary only and does not necessarily provide the IC with a perfect protection from any kind of damages.

**4. Thermal Shutdown Circuit (TSD)**

The TB6643KQ incorporates a thermal shutdown circuit. If the junction temperature ( $T_j$ ) exceeds 170°C (typ.), all the output transistors are turned off (Hi-Z).

The shutdown is released and the TB6643KQ resumes the normal operation when both the IN1 pin and IN2 pin are driven Low.

TSD = 170°C (typ.)

TSD operation

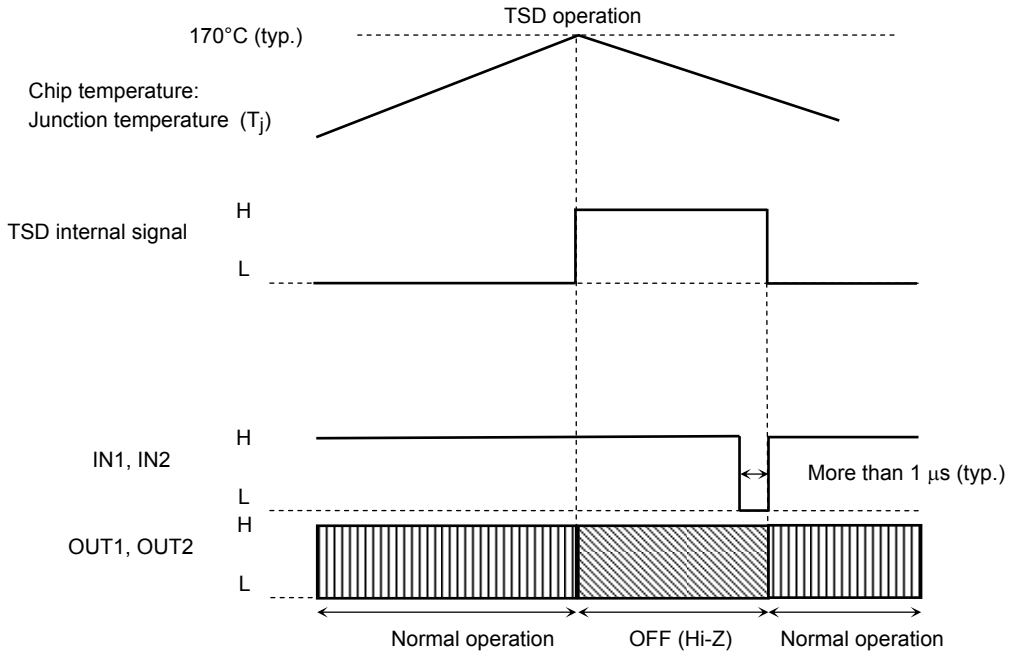

**Note:** The TSD circuit is activated when the junction temperature ( $T_j$ ) violates the rating temperature of 150°C. Note that the circuit is provided as an auxiliary only and does not necessarily provide the IC with a perfect protection from any kind of damages.

**5. Overcurrent Shutdown Circuits (ISD)**

The TB6643KQ incorporates overcurrent shutdown (ISD) circuits monitoring the current that flows through each of all the four output power transistors.

The threshold current ranges from 4.5 A to 8 A. If any of the ISDs detects an overcurrent for more than 5.1  $\mu\text{s}$  (typ.), which is the predefined detection time, all the output transistors are turned off and enter High impedance state.

The shutdown is released and the TB6643KQ resumes the normal operation when both the IN1 pin and IN2 pin are driven Low.

ISD operation

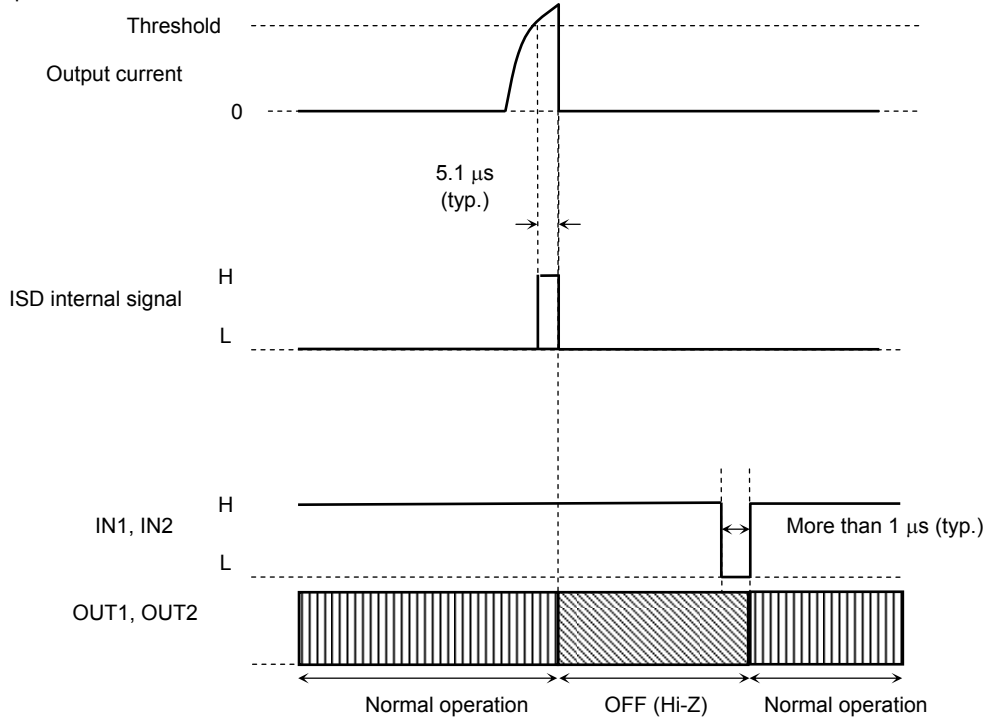

Note: The ISD is activated if the absolute maximum current rating is violated. Note that the circuit is provided as an auxiliary only and does not necessarily provide the IC with a perfect protection from damages due to overcurrent caused by power fault, ground fault, load-short and the like.

**6. PWM Control**

Switching input through the IN1 and IN2 pins enables the PWM control of the motor driver. When the motor drive is controlled by the PWM input, the TB6643KQ repeats operating in Normal Operation mode and Short Brake mode alternately.

For preventing the shoot-through current in the output circuit caused by the upper and lower power transistors being turned on simultaneously, the dead time is internally generated at the time the upper and lower power transistors switches between on and off.

This eliminates the need of inserting Off time externally; thus the PWM control with synchronous rectification is enabled.

Note that inserting Off time externally is not required on operation mode changes between CW and CCW, and CW (CCW) and Short Brake, again, because of the dead time generated internally.

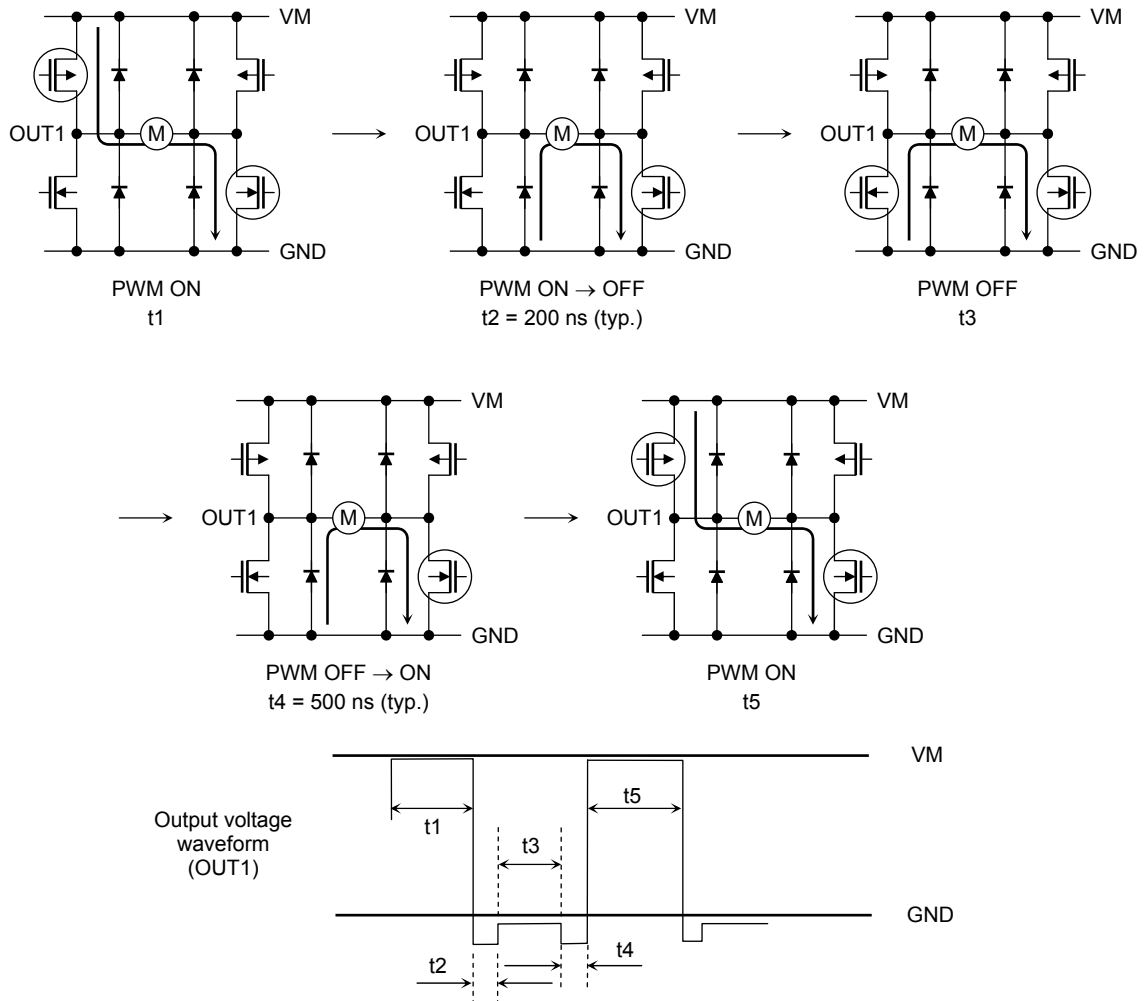

## 7. Output Circuits

The switching characteristics of the output transistors provided to the OUT1 pin and OUT2 pin are as follows:

Characteristic	Value	Unit
$t_{pLH}$	650 (typ.)	ns
$t_{pHL}$	450 (typ.)	
$t_r$	90 (typ.)	
$t_f$	130 (typ.)	

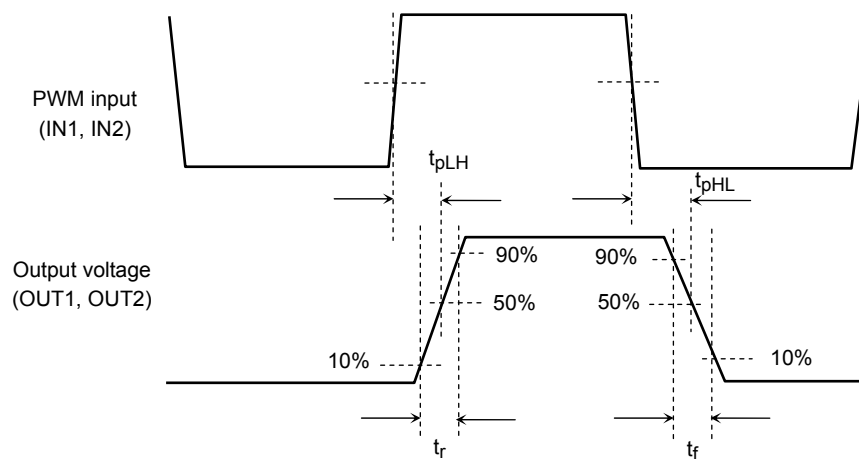

## Package Dimensions

HSIP7-P-2.54A

Unit : mm

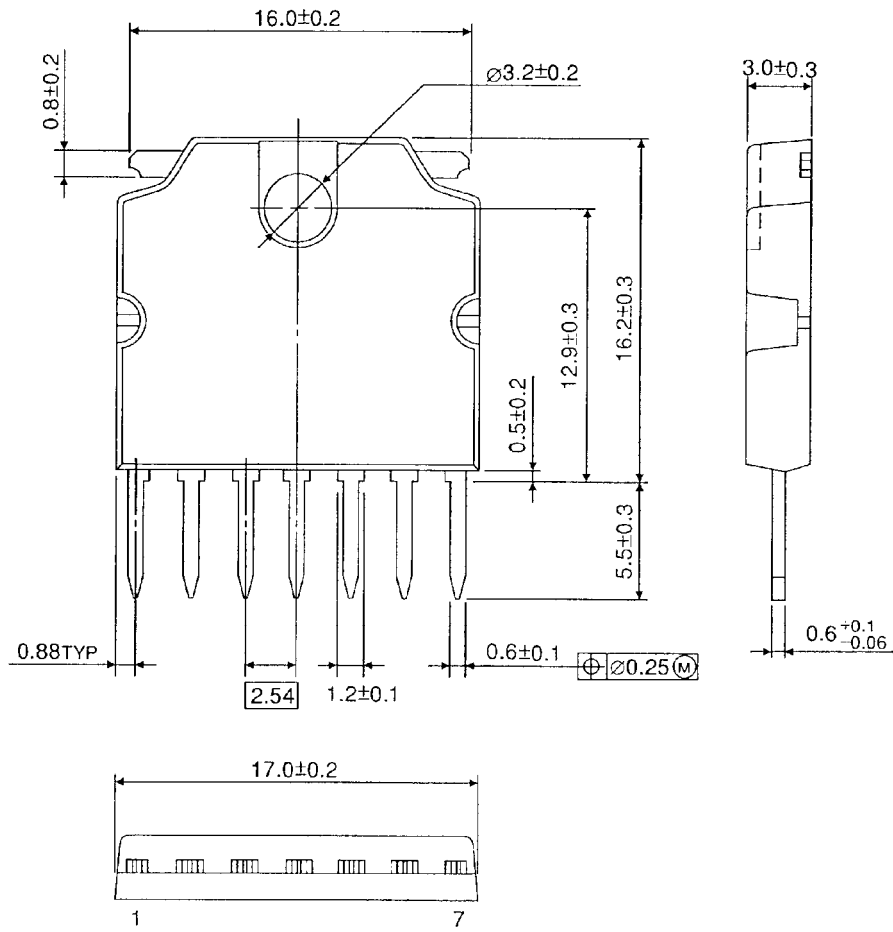

Weight: 2.2 g (typ.)

## Notes on Contents

### 1. Block Diagrams

Some of the functional blocks, circuits, or constants in the block diagram may be omitted or simplified for explanatory purposes.

### 2. Equivalent Circuits

The equivalent circuit diagrams may be simplified or some parts of them may be omitted for explanatory purposes.

### 3. Timing Charts

Timing charts may be simplified for explanatory purposes.

### 4. Application Circuits

The application circuits shown in this document are provided for reference purposes only. Thorough evaluation is required, especially at the mass production design stage.

Toshiba does not grant any license to any industrial property rights by providing these examples of application circuits.

### 5. Test Circuits

Components in the test circuits are used only to obtain and confirm the device characteristics. These components and circuits are not guaranteed to prevent malfunction or failure from occurring in the application equipment.

## IC Usage Considerations

### Notes on Handling of ICs

- (1) The absolute maximum ratings of a semiconductor device are a set of ratings that must not be exceeded, even for a moment. Do not exceed any of these ratings.  
Exceeding the rating(s) may cause the device breakdown, damage or deterioration, and may result injury by explosion or combustion.
- (2) Use an appropriate power supply fuse to ensure that a large current does not continuously flow in case of over current and/or IC failure. The IC will fully break down when used under conditions that exceed its absolute maximum ratings, when the wiring is routed improperly or when an abnormal pulse noise occurs from the wiring or load, causing a large current to continuously flow and the breakdown can lead smoke or ignition. To minimize the effects of the flow of a large current in case of breakdown, appropriate settings, such as fuse capacity, fusing time and insertion circuit location, are required.
- (3) If your design includes an inductive load such as a motor coil, incorporate a protection circuit into the design to prevent device malfunction or breakdown caused by the current resulting from the inrush current at power ON or the negative current resulting from the back electromotive force at power OFF. IC breakdown may cause injury, smoke or ignition.  
Use a stable power supply with ICs with built-in protection functions. If the power supply is unstable, the protection function may not operate, causing IC breakdown. IC breakdown may cause injury, smoke or ignition.
- (4) Do not insert devices in the wrong orientation or incorrectly.  
Make sure that the positive and negative terminals of power supplies are connected properly. Otherwise, the current or power consumption may exceed the absolute maximum rating, and exceeding the rating(s) may cause the device breakdown, damage or deterioration, and may result injury by explosion or combustion.  
In addition, do not use any device that is applied the current with inserting in the wrong orientation or incorrectly even just one time.

**Points to Remember on Handling of ICs**

- (1) **Over Current Protection Circuit**

Over current protection circuits (referred to as current limiter circuits) do not necessarily protect ICs under all circumstances. If the Over current protection circuits operate against the over current, clear the over current status immediately.

Depending on the method of use and usage conditions, such as exceeding absolute maximum ratings can cause the over current protection circuit to not operate properly or IC breakdown before operation. In addition, depending on the method of use and usage conditions, if over current continues to flow for a long time after operation, the IC may generate heat resulting in breakdown.
- (2) **Thermal Shutdown Circuit**

Thermal shutdown circuits do not necessarily protect ICs under all circumstances. If the thermal shutdown circuits operate against the over temperature, clear the heat generation status immediately. Depending on the method of use and usage conditions, such as exceeding absolute maximum ratings can cause the thermal shutdown circuit to not operate properly or IC breakdown before operation.
- (3) **Heat Radiation Design**

In using an IC with large current flow such as power amp, regulator or driver, please design the device so that heat is appropriately radiated, not to exceed the specified junction temperature ( $T_j$ ) at any time and condition. These ICs generate heat even during normal use. An inadequate IC heat radiation design can lead to decrease in IC life, deterioration of IC characteristics or IC breakdown. In addition, please design the device taking into consideration the effect of IC heat radiation with peripheral components.
- (4) **Back-EMF**

When a motor rotates in the reverse direction, stops or slows down abruptly, a current flow back to the motor's power supply due to the effect of back-EMF. If the current sink capability of the power supply is small, the device's motor power supply and output pins might be exposed to conditions beyond maximum ratings. To avoid this problem, take the effect of back-EMF into consideration in system design.

## RESTRICTIONS ON PRODUCT USE

- Toshiba Corporation, and its subsidiaries and affiliates (collectively "TOSHIBA"), reserve the right to make changes to the information in this document, and related hardware, software and systems (collectively "Product") without notice.
- This document and any information herein may not be reproduced without prior written permission from TOSHIBA. Even with TOSHIBA's written permission, reproduction is permissible only if reproduction is without alteration/omission.
- Though TOSHIBA works continually to improve Product's quality and reliability, Product can malfunction or fail. Customers are responsible for complying with safety standards and for providing adequate designs and safeguards for their hardware, software and systems which minimize risk and avoid situations in which a malfunction or failure of Product could cause loss of human life, bodily injury or damage to property, including data loss or corruption. Before customers use the Product, create designs including the Product, or incorporate the Product into their own applications, customers must also refer to and comply with (a) the latest versions of all relevant TOSHIBA information, including without limitation, this document, the specifications, the data sheets and application notes for Product and the precautions and conditions set forth in the "TOSHIBA Semiconductor Reliability Handbook" and (b) the instructions for the application with which the Product will be used with or for. Customers are solely responsible for all aspects of their own product design or applications, including but not limited to (a) determining the appropriateness of the use of this Product in such design or applications; (b) evaluating and determining the applicability of any information contained in this document, or in charts, diagrams, programs, algorithms, sample application circuits, or any other referenced documents; and (c) validating all operating parameters for such designs and applications. **TOSHIBA ASSUMES NO LIABILITY FOR CUSTOMERS' PRODUCT DESIGN OR APPLICATIONS.**
- Product is intended for use in general electronics applications (e.g., computers, personal equipment, office equipment, measuring equipment, industrial robots and home electronics appliances) or for specific applications as expressly stated in this document. Product is neither intended nor warranted for use in equipment or systems that require extraordinarily high levels of quality and/or reliability and/or a malfunction or failure of which may cause loss of human life, bodily injury, serious property damage or serious public impact ("Unintended Use"). Unintended Use includes, without limitation, equipment used in nuclear facilities, equipment used in the aerospace industry, medical equipment, equipment used for automobiles, trains, ships and other transportation, traffic signaling equipment, equipment used to control combustions or explosions, safety devices, elevators and escalators, devices related to electric power, and equipment used in finance-related fields. Do not use Product for Unintended Use unless specifically permitted in this document.
- Do not disassemble, analyze, reverse-engineer, alter, modify, translate or copy Product, whether in whole or in part.
- Product shall not be used for or incorporated into any products or systems whose manufacture, use, or sale is prohibited under any applicable laws or regulations.
- The information contained herein is presented only as guidance for Product use. No responsibility is assumed by TOSHIBA for any infringement of patents or any other intellectual property rights of third parties that may result from the use of Product. No license to any intellectual property right is granted by this document, whether express or implied, by estoppel or otherwise.
- **ABSENT A WRITTEN SIGNED AGREEMENT, EXCEPT AS PROVIDED IN THE RELEVANT TERMS AND CONDITIONS OF SALE FOR PRODUCT, AND TO THE MAXIMUM EXTENT ALLOWABLE BY LAW, TOSHIBA (1) ASSUMES NO LIABILITY WHATSOEVER, INCLUDING WITHOUT LIMITATION, INDIRECT, CONSEQUENTIAL, SPECIAL, OR INCIDENTAL DAMAGES OR LOSS, INCLUDING WITHOUT LIMITATION, LOSS OF PROFITS, LOSS OF OPPORTUNITIES, BUSINESS INTERRUPTION AND LOSS OF DATA, AND (2) DISCLAIMS ANY AND ALL EXPRESS OR IMPLIED WARRANTIES AND CONDITIONS RELATED TO SALE, USE OF PRODUCT, OR INFORMATION, INCLUDING WARRANTIES OR CONDITIONS OF MERCHANTABILITY, FITNESS FOR A PARTICULAR PURPOSE, ACCURACY OF INFORMATION, OR NONINFRINGEMENT.**
- Do not use or otherwise make available Product or related software or technology for any military purposes, including without limitation, for the design, development, use, stockpiling or manufacturing of nuclear, chemical, or biological weapons or missile technology products (mass destruction weapons). Product and related software and technology may be controlled under the Japanese Foreign Exchange and Foreign Trade Law and the U.S. Export Administration Regulations. Export and re-export of Product or related software or technology are strictly prohibited except in compliance with all applicable export laws and regulations.
- Please contact your TOSHIBA sales representative for details as to environmental matters such as the RoHS compatibility of Product. Please use Product in compliance with all applicable laws and regulations that regulate the inclusion or use of controlled substances, including without limitation, the EU RoHS Directive. TOSHIBA assumes no liability for damages or losses occurring as a result of noncompliance with applicable laws and regulations.

## Looking for pricing, stock, or lifecycle information?

Click below to explore more details on WIN SOURCE:

- [View TB6643KQ,8 on WIN SOURCE](#)
- [Toshiba Semiconductor and Storage Information](#)

## Optimize Your Supply Chain with WIN SOURCE Solutions

- ✓ Global Sourcing Solution
- ✓ Obsolete Management
- ✓ Cost Control Management
- ✓ Shortage Management
- ✓ Alternative Solution
- ✓ Excess Inventory Management