



THE DATASHEET OF OPA728AIDRBT





e-trim[™] 20MHz, High Precision CMOS Operational Amplifier

FEATURES

- **OFFSET:** 15 μ V (typ), 150 μ V (max)
- **DRIFT:** 0.3 μ V/ $^{\circ}$ C (typ), 1.5 μ V/ $^{\circ}$ C (max)
- **BANDWIDTH:** 20MHz
- **SLEW RATE:** 30V/ μ s
- **BIAS CURRENT:** 500pA (max)
- **LOW NOISE:** 6nV/ $\sqrt{\text{Hz}}$ at 100kHz
- **THD+N:** 0.0003% at 1kHz
- **QUIESCENT CURRENT:** 4.3mA/ch
- **SUPPLY VOLTAGE:** 4V to 12V
- **SHUTDOWN MODE (OPA728):** 6 μ A

APPLICATIONS

- OPTICAL NETWORKING
- TRANSIMPEDANCE AMPLIFIERS
- INTEGRATORS
- ACTIVE FILTERS
- A/D CONVERTER DRIVERS
- I/V CONVERTER FOR DACs
- HIGH PERFORMANCE AUDIO
- PROCESS CONTROL
- TEST EQUIPMENT

OPAx727 AND OPAx728 RELATED PRODUCTS

FEATURES	PRODUCT
20MHz, 3mV, 4 μ V/ $^{\circ}$ C (non- <i>e-trim</i> version of OPA727)	OPA725
20MHz, 3mV, 4 μ V/ $^{\circ}$ C, Shutdown (non- <i>e-trim</i> version of OPA728)	OPA726

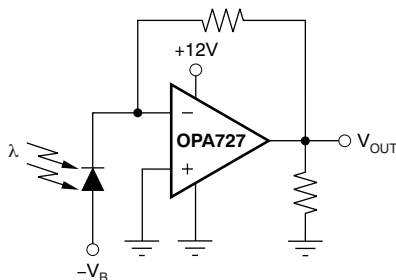

DESCRIPTION

The OPA727 and OPA728 series op amps use a state-of-the-art 12V analog CMOS process and *e-trim*, a package-level trim, offering outstanding dc precision and ac performance. The extremely low offset (150 μ V max) and drift (1.5 μ V/ $^{\circ}$ C) are achieved by trimming the IC digitally after packaging to avoid the shift in parameters as a result of stresses during package assembly. To correct for offset drift, the OPA727 and OPA728 family is trimmed over temperature. The devices feature very high CMRR and open-loop gain to minimize errors.

Excellent ac characteristics, such as 20MHz GBW, 30V/ μ s slew rate and 0.0003% THD+N make the OPA727 and OPA728 well-suited for communication, high-end audio, and active filter applications. With a bias current of less than 500pA, they are well suited for use as transimpedance (I/V-conversion) amplifiers for monitoring optical power in ONET applications.

Optimized for single-supply operation up to 12V, the input common-mode range extends to GND for true single-supply functionality. The output swings to within 150mV of the rails, maximizing dynamic range. The low quiescent current of 4.3mA makes it well-suited for use in battery-operated equipment. The OPA728 shutdown version reduces the quiescent current to typically 6 μ A and features a reference pin for easy shutdown operation with standard CMOS logic in dual-supply applications.

For ease of use, the OPA727 and OPA728 op amp families are fully specified and tested over the supply range of 4V to 12V. The OPA727 (single) and OPA728 (single with shutdown) are available in MSOP-8 and DFN-8; the OPA2727 (dual) is available in DFN-8 and SO-8; and the quad version OPA4727 in TSSOP-14. All versions are specified for operation from -40° C to $+125^{\circ}$ C.



Please be aware that an important notice concerning availability, standard warranty, and use in critical applications of Texas Instruments semiconductor products and disclaimers thereto appears at the end of this data sheet.

e-trim is a trademark of Texas Instruments.
All other trademarks are the property of their respective owners.



This integrated circuit can be damaged by ESD. Texas Instruments recommends that all integrated circuits be handled with appropriate precautions. Failure to observe proper handling and installation procedures can cause damage.

ESD damage can range from subtle performance degradation to complete device failure. Precision integrated circuits may be more susceptible to damage because very small parametric changes could cause the device not to meet its published specifications.

PACKAGE/ORDERING INFORMATION⁽¹⁾

PRODUCT	PACKAGE-LEAD	PACKAGE DESIGNATOR	PACKAGE MARKING
Non-Shutdown			
OPA727	MSOP-8	DGK	AUE
	DFN-8	DRB	NSF
OPA2727	DFN-8	DRB	NSD
	SO-8	D	O2727A
OPA4727	TSSOP-14	PW	OPA4727
Shutdown			
OPA728	MSOP-8	DGK	AUF
	DFN-8	DRB	NSG

(1) For the most current package and ordering information see the Package Option Addendum at the end of this document, or see the TI web site at www.ti.com.

ABSOLUTE MAXIMUM RATINGS⁽¹⁾

		OPA727, OPA2727 OPA4727, OPA728	UNIT
Supply Voltage		+13.2	V
Signal Input Terminals	Voltage ⁽²⁾	-0.5 to (V+) + 0.5	V
	Current ⁽²⁾	±10	mA
Output Short-Circuit ⁽³⁾		Continuous	
Operating Temperature		-55 to +125	°C
Storage Temperature		-55 to +150	°C
Junction Temperature		+150	°C
ESD Rating	Human Body Model	2000	V
	Charged Device Model	1000	V

(1) Stresses above these ratings may cause permanent damage. Exposure to absolute maximum conditions for extended periods may degrade device reliability. These are stress ratings only, and functional operation of the device at these or any other conditions beyond those specified is not supported.

(2) Input terminals are diode-clamped to the power-supply rails. Input signals that can swing more than 0.5V beyond the supply rails should be current limited to 10mA or less.

(3) Short-circuit to ground, one amplifier per package.

PIN CONFIGURATIONS

**OPA727
MSOP-8
(TOP VIEW)**

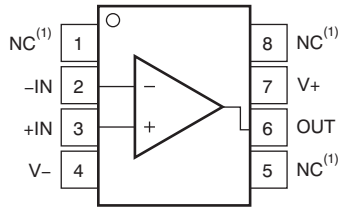

**OPA727
DFN-8
(TOP VIEW)**

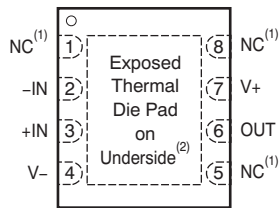

**OPA728
MSOP-8
(TOP VIEW)**

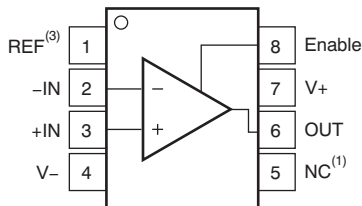

**OPA728
DFN-8
(TOP VIEW)**

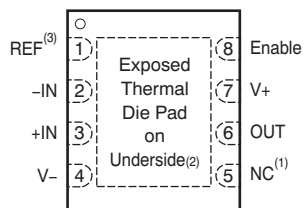

**OPA2727
SO-8
(TOP VIEW)**

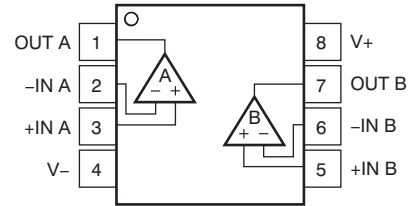

**OPA2727
DFN-8
(TOP VIEW)**

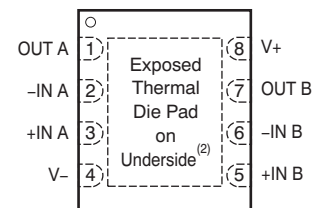

**OPA4727
TSSOP-14
(TOP VIEW)**

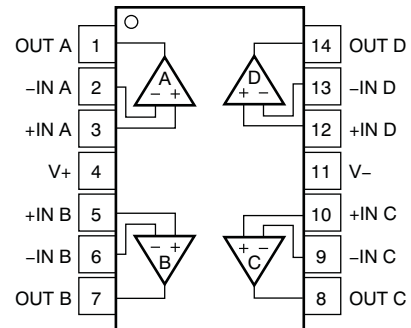

Notes:

1. NC denotes no internal connection.
2. Connect thermal die pad to V-.
3. REF is the reference voltage for ENABLE pin.

ELECTRICAL CHARACTERISTICS: $V_S = +4V$ to $+12V$ or $V_S = \pm 2V$ to $\pm 6V$

Boldface limits apply over the specified temperature range, $T_A = -40^\circ\text{C}$ to $+125^\circ\text{C}$.

At $T_A = +25^\circ\text{C}$, $R_L = 10\text{k}\Omega$ connected to $V_S/2$, and $V_{OUT} = V_S/2$, unless otherwise noted.

PARAMETER	CONDITIONS	OPA727, OPA728, OPA2727, OPA4727			UNIT
		MIN	TYP	MAX	
OFFSET VOLTAGE					
Input Offset Voltage	V_{OS} $V_S = \pm 5V, V_{CM} = 0V$				
OPA727 DFN, OPA728 DFN Packages			15	150	μV
OPA727 MSOP, OPA728 MSOP Packages			15	300	μV
OPA2727			15	150	μV
OPA4727			15	175	μV
Drift	dV_{OS}/dT 0°C to $+85^\circ\text{C}$		0.3	1.5	$\mu\text{V}/^\circ\text{C}$
	-40°C to $+125^\circ\text{C}$		0.6	3	$\mu\text{V}/^\circ\text{C}$
vs Power Supply	PSRR $V_S = \pm 2V$ to $\pm 6V, V_{CM} = V-$		30	150	$\mu\text{V}/\text{V}$
Over Temperature	$V_S = \pm 2V$ to $\pm 6V, V_{CM} = V-$			150	$\mu\text{V}/\text{V}$
Channel Separation, dc			1		$\mu\text{V}/\text{V}$
INPUT BIAS CURRENT					
Input Bias Current			± 85	± 500	pA
Over Temperature			See Typical Characteristics		
Input Offset Current	I_{OS}		± 10	± 100	pA
NOISE					
Input Voltage Noise, $f = 0.1\text{Hz}$ to 10Hz	e_n $V_S = \pm 6V, V_{CM} = 0V$		10		μV_{PP}
Input Voltage Noise Density, $f = 10\text{kHz}$	e_n $V_S = \pm 6V, V_{CM} = 0V$		10		$\text{nV}/\sqrt{\text{Hz}}$
Input Voltage Noise Density, $f = 100\text{kHz}$	e_n $V_S = \pm 6V, V_{CM} = 0V$		6		$\text{nV}/\sqrt{\text{Hz}}$
Input Current Noise Density, $f = 1\text{kHz}$	i_n $V_S = \pm 6V, V_{CM} = 0V$		2.5		$\text{fA}/\sqrt{\text{Hz}}$
INPUT VOLTAGE RANGE					
Common-Mode Voltage Range	V_{CM}	(V-)		(V+)-2.5	V
Common-Mode Rejection Ratio	CMRR	$(V-) \leq V_{CM} \leq (V+) - 2.5V$	86	94	dB
Over Temperature		$(V-) \leq V_{CM} \leq (V+) - 2.5V$	84		dB
		$(V-) \leq V_{CM} \leq (V+) - 3V$	94	100	dB
Over Temperature		$(V-) \leq V_{CM} \leq (V+) - 3V$	84		dB
INPUT IMPEDANCE					
Differential			$10^{11} \parallel 5$		$\Omega \parallel \text{pF}$
Common-Mode			$10^{11} \parallel 4$		$\Omega \parallel \text{pF}$
OPEN-LOOP GAIN					
Open-Loop Voltage Gain	A_{OL}	$R_L = 100\text{k}\Omega, 0.15V < V_O < (V+) - 0.15V$	110	120	dB
Over Temperature		$R_L = 100\text{k}\Omega, 0.15V < V_O < (V+) - 0.15V$	100		dB
		$R_L = 1\text{k}\Omega, 0.25V < V_O < (V+) - 0.25V$	106	116	dB
Over Temperature, OPA727, OPA728		$R_L = 1\text{k}\Omega, 0.25V < V_O < (V+) - 0.25V$	96		dB
Over Temperature, OPA2727, OPA4727		$R_L = 1\text{k}\Omega, 0.35V < V_O < (V+) - 0.35V$	96		dB
FREQUENCY RESPONSE					
Gain-Bandwidth Product	GBW	$C_L = 20\text{pF}$		20	MHz
Slew Rate	SR	$G = +1$		30	$\text{V}/\mu\text{s}$
Settling Time, 0.1%	t_s	$V_S = \pm 6V, 5V$ Step, $G = +1$		350	ns
0.01%		$V_S = \pm 6V, 5V$ Step, $G = +1$		450	ns
Overload Recovery Time		$V_{IN} \times \text{Gain} > V_S$		50	ns
Total Harmonic Distortion + Noise	THD+N	$V_S = \pm 6V, V_{OUT} = 2V_{RMS}, R_L = 600\Omega, G = +1, f = 1\text{kHz}$		0.003	%

ELECTRICAL CHARACTERISTICS: $V_S = +4V$ to $+12V$ or $V_S = \pm 2V$ to $\pm 6V$ (continued)
Boldface limits apply over the specified temperature range, $T_A = -40^\circ\text{C}$ to $+125^\circ\text{C}$.

 At $T_A = +25^\circ\text{C}$, $R_L = 10\text{k}\Omega$ connected to $V_S/2$, and $V_{OUT} = V_S/2$, unless otherwise noted.

PARAMETER	CONDITIONS	OPA727, OPA728, OPA2727, OPA4727			UNIT
		MIN	TYP	MAX	
OUTPUT					
Voltage Output Swing from Rail					
	$R_L = 100\text{k}\Omega$, $A_{OL} > 110\text{dB}$		100	150	mV
Over Temperature	$R_L = 100\text{k}\Omega$, $A_{OL} > 100\text{dB}$			150	mV
	$R_L = 1\text{k}\Omega$, $A_{OL} > 106\text{dB}$		200	250	mV
Over Temperature, OPA727, OPA728	$R_L = 1\text{k}\Omega$, $A_{OL} > 96\text{dB}$			250	mV
Over Temperature, OPA2727, OPA4727	$R_L = 1\text{k}\Omega$, $A_{OL} > 96\text{dB}$			350	mV
Output Current	I_{OUT} $ V_S - V_{OUT} < 1V$		40		mA
Short-Circuit Current	I_{SC}		± 55		mA
Capacitive Load Drive	C_{LOAD}	See Typical Characteristics			
Open-Loop Output Impedance	$f = 1\text{MHz}$, $I_O = 0$		40		Ω
ENABLE/SHUTDOWN (OPA728)					
t_{OFF}			5		μs
t_{ON}			80		μs
Enable Reference (Ref Pin) Voltage Range		V_-		$(V_+) - 2$	V
V_L (amplifier is disabled)				$< V_{DGND} + 0.8V$	V
V_H (amplifier is enabled)		$> V_{DGND} + 2V$			V
Input Bias Current of Enable Pin			5		pA
I_{QSD}	Amplifier Disabled		6	15	μA
POWER SUPPLY					
Specified Voltage Range	V_S	4		12	V
Operating Voltage Range	V_S		3.5 to 13.2		V
Quiescent Current (per amplifier)	I_Q		4.3	6.5	mA
Over Temperature				6.5	mA
TEMPERATURE RANGE					
Specified Range		-40		+125	$^\circ\text{C}$
Operating Range		-55		+125	$^\circ\text{C}$
Storage Range		-55		+150	$^\circ\text{C}$
Thermal Resistance	θ_{JA}				
MSOP-8, SO-8			150		$^\circ\text{C/W}$
TSSOP-14			100		$^\circ\text{C/W}$
DFN-8			46		$^\circ\text{C/W}$

TYPICAL CHARACTERISTICS

At $T_A = +25^\circ\text{C}$, $V_S = \pm 6\text{V}$, $R_L = 10\text{k}\Omega$ connected to $V_S/2$, and $V_{OUT} = V_S/2$, unless otherwise noted.

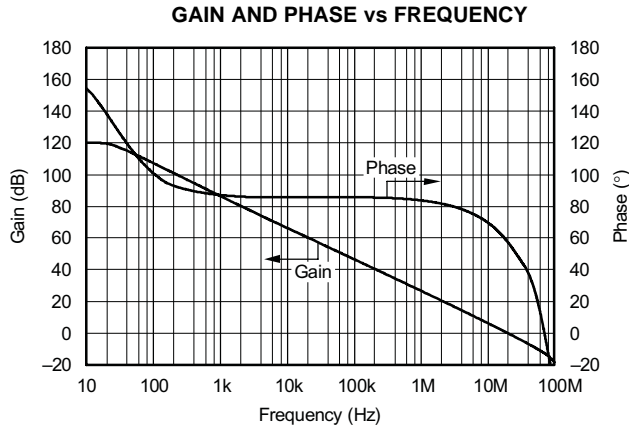

Figure 1.

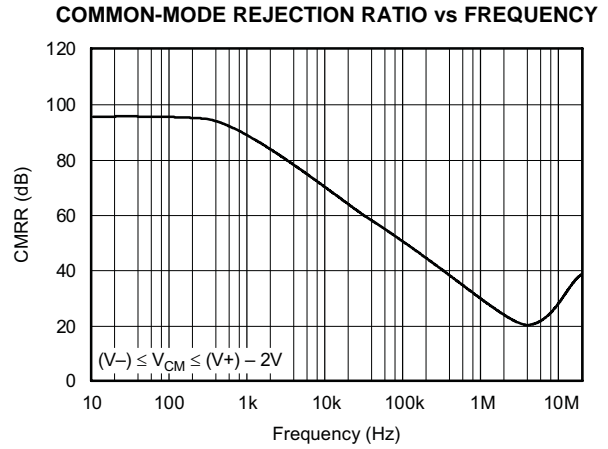

Figure 2.

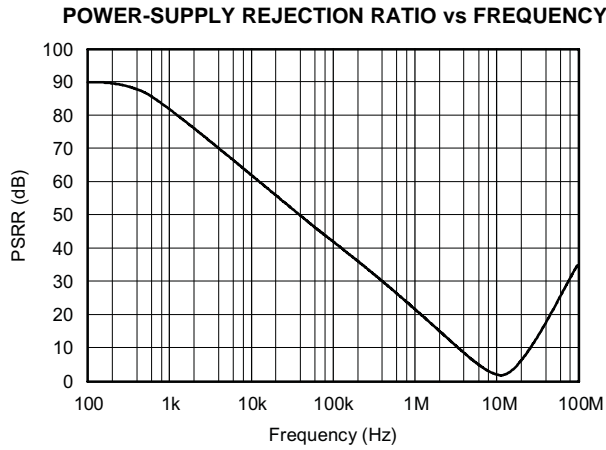

Figure 3.

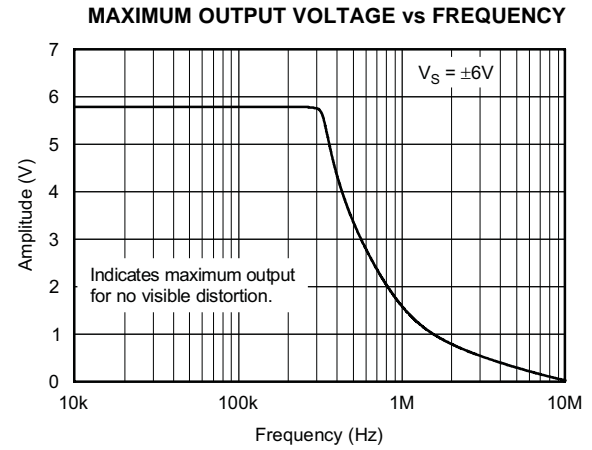

Figure 4.

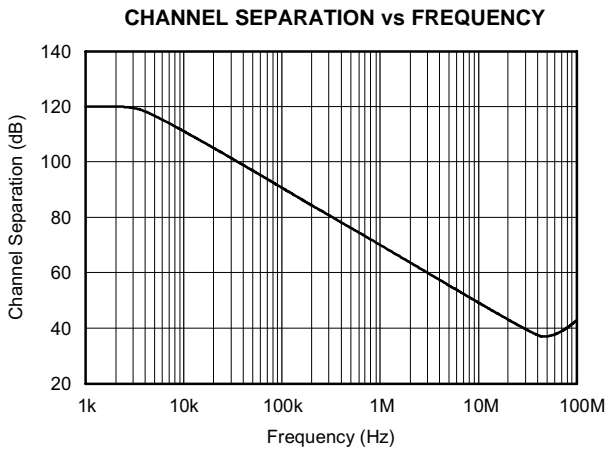

Figure 5.

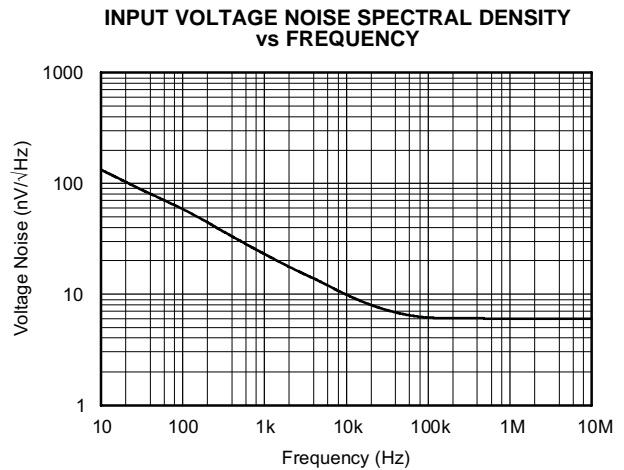

Figure 6.

TYPICAL CHARACTERISTICS (continued)

At $T_A = +25^\circ\text{C}$, $V_S = \pm 6\text{V}$, $R_L = 10\text{k}\Omega$ connected to $V_S/2$, and $V_{OUT} = V_S/2$, unless otherwise noted.

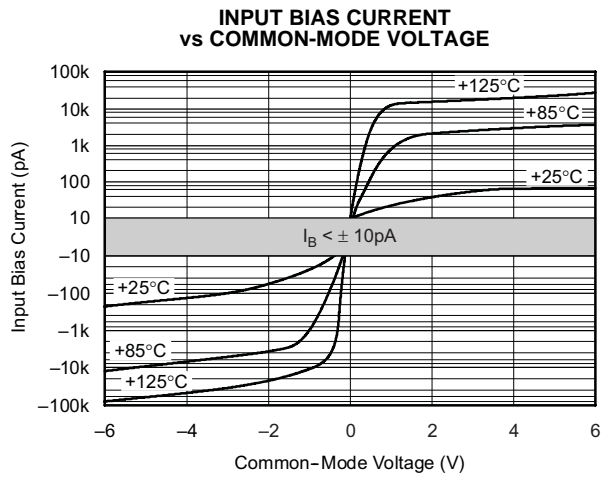

Figure 7.

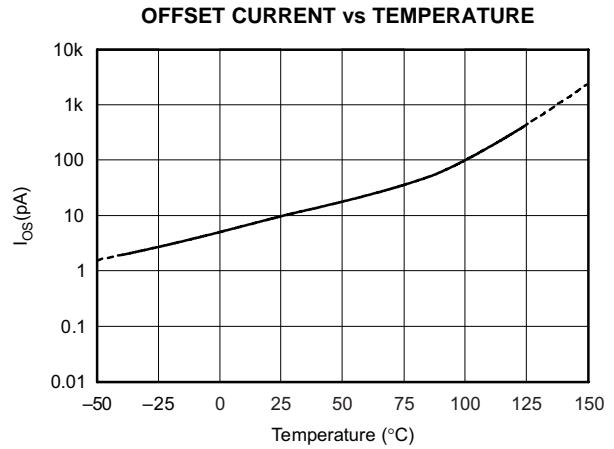

Figure 8.

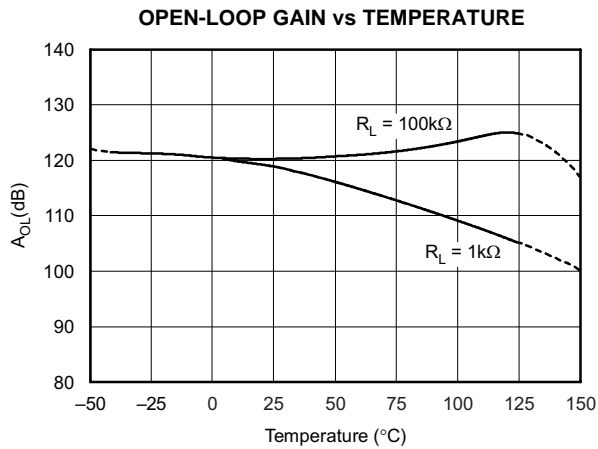

Figure 9.

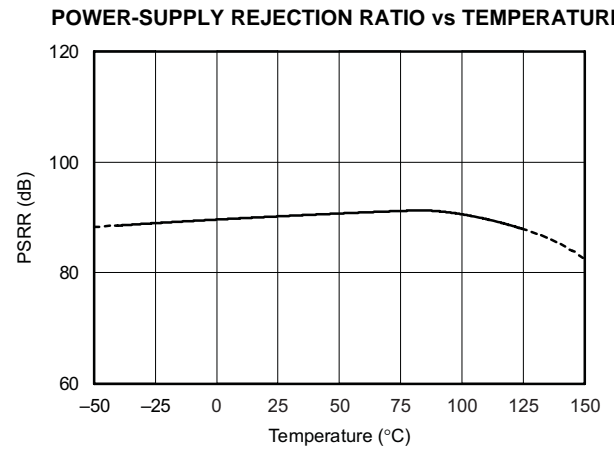

Figure 10.

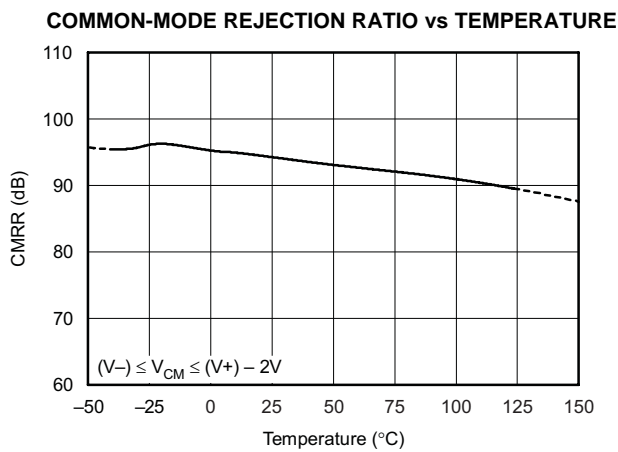

Figure 11.

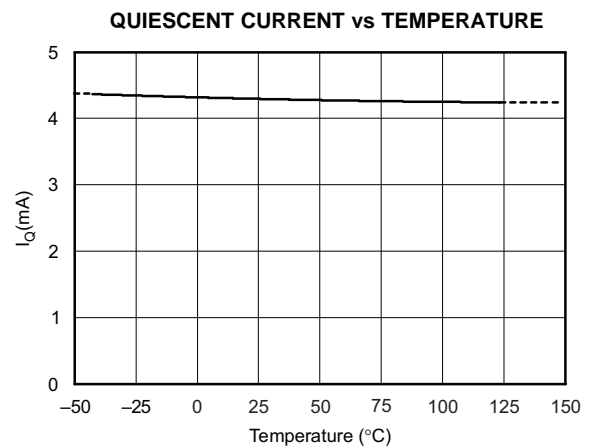

Figure 12.

TYPICAL CHARACTERISTICS (continued)

At $T_A = +25^\circ\text{C}$, $V_S = \pm 6\text{V}$, $R_L = 10\text{k}\Omega$ connected to $V_S/2$, and $V_{OUT} = V_S/2$, unless otherwise noted.

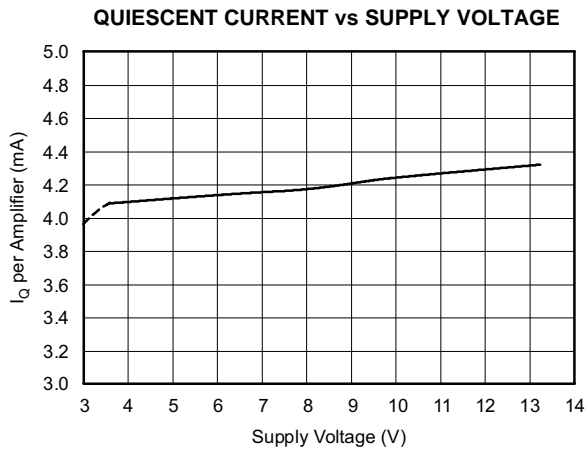

Figure 13.

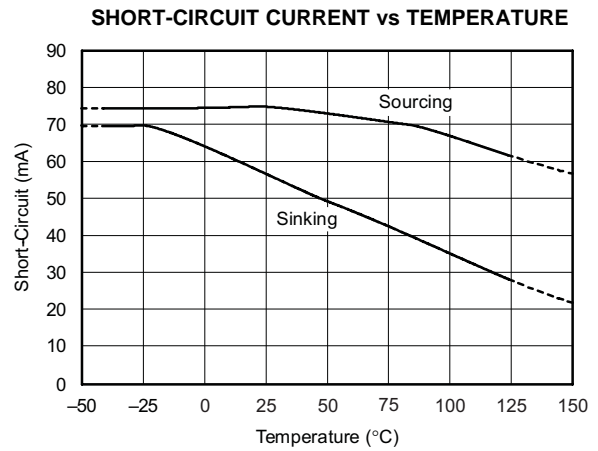

Figure 14.

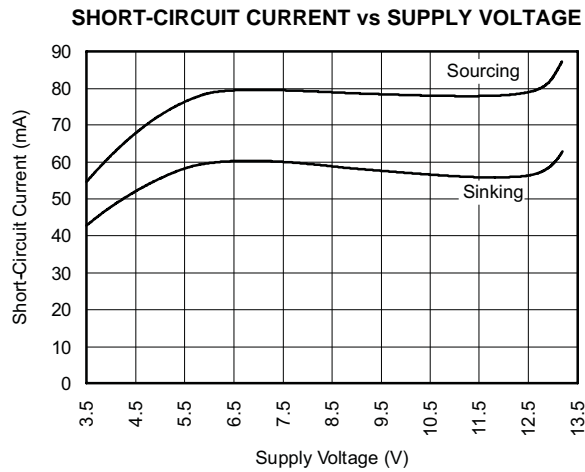

Figure 15.

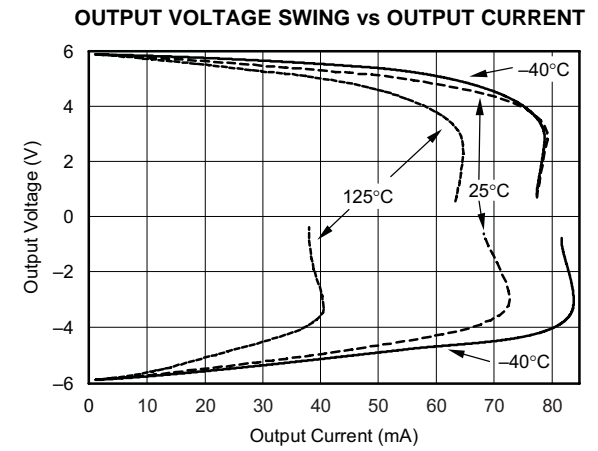

Figure 16.

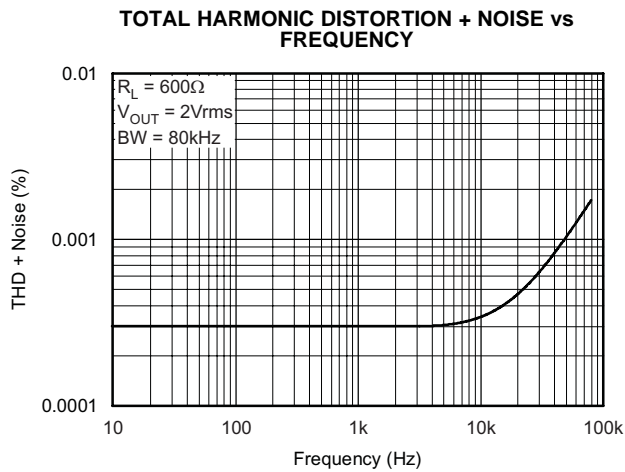

Figure 17.

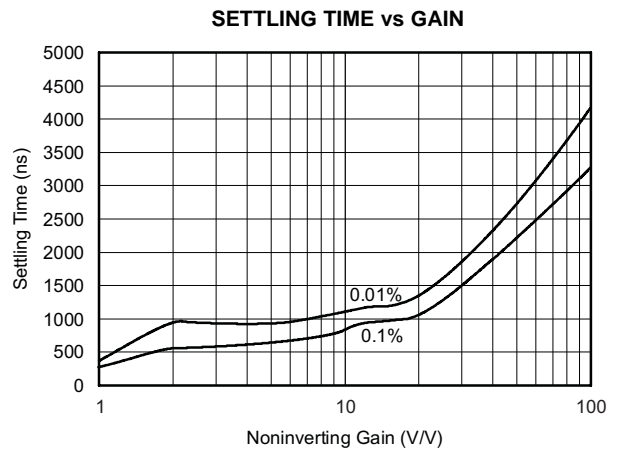

Figure 18.

TYPICAL CHARACTERISTICS (continued)

At $T_A = +25^\circ\text{C}$, $V_S = \pm 6\text{V}$, $R_L = 10\text{k}\Omega$ connected to $V_S/2$, and $V_{OUT} = V_S/2$, unless otherwise noted.

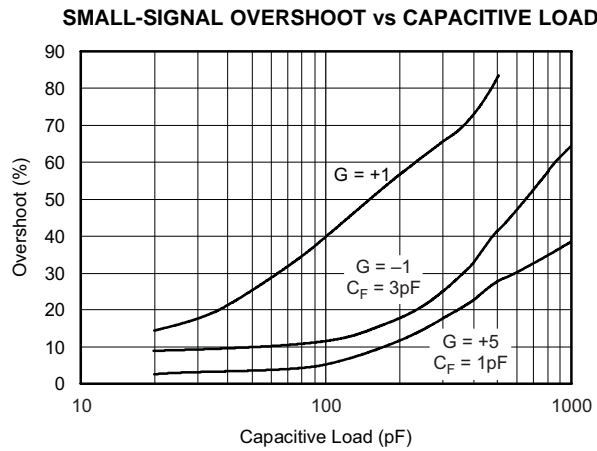

Figure 19.

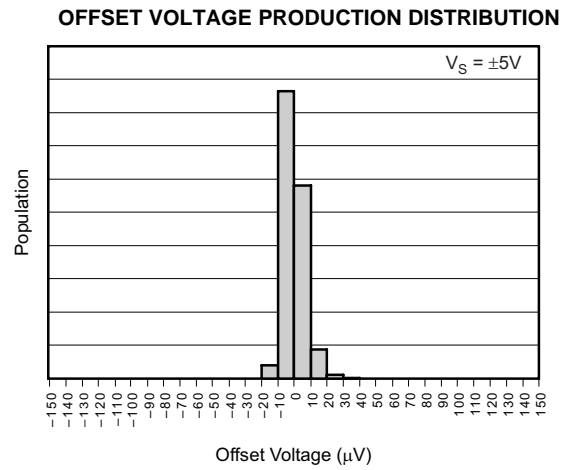

Figure 20.

OFFSET VOLTAGE DRIFT PRODUCTION DISTRIBUTION (0°C TO +85°C)

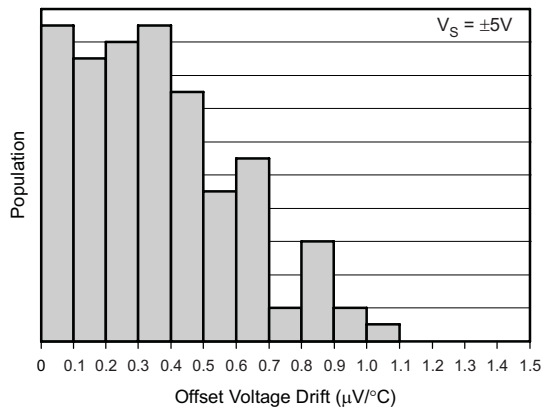

Figure 21.

OFFSET VOLTAGE DRIFT PRODUCTION DISTRIBUTION (-40°C TO +125°C)

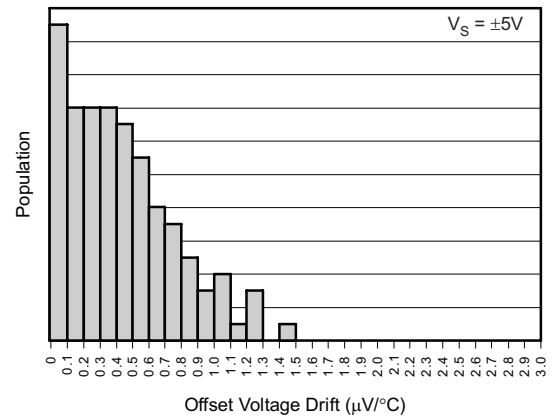

Figure 22.

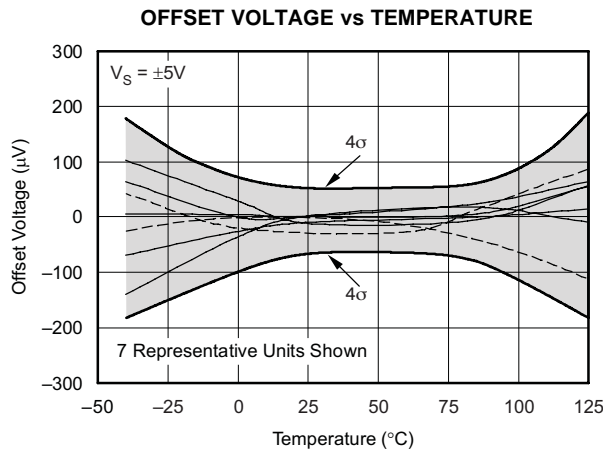

Figure 23.

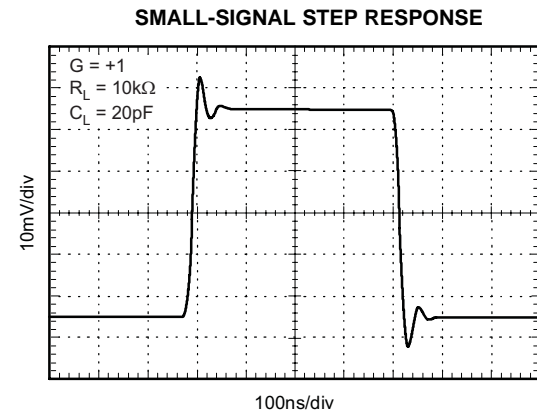

Figure 24.

TYPICAL CHARACTERISTICS (continued)

At $T_A = +25^\circ\text{C}$, $V_S = \pm 6\text{V}$, $R_L = 10\text{k}\Omega$ connected to $V_S/2$, and $V_{OUT} = V_S/2$, unless otherwise noted.

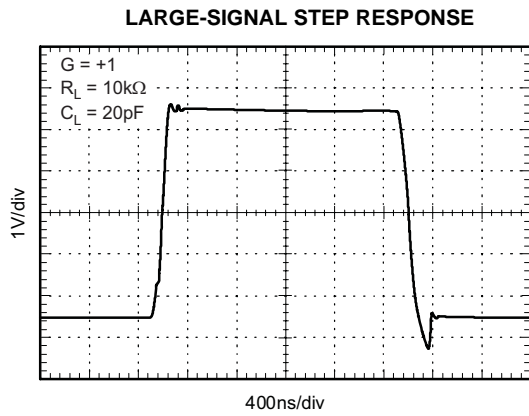

Figure 25.

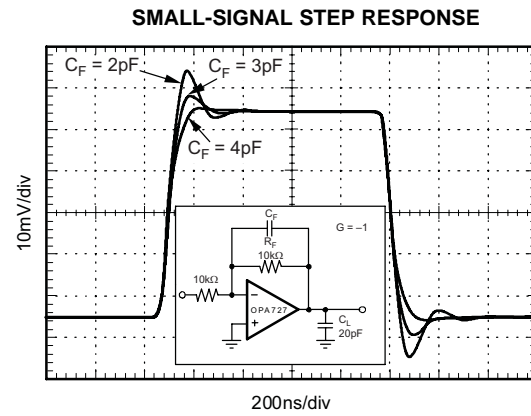

Figure 26.

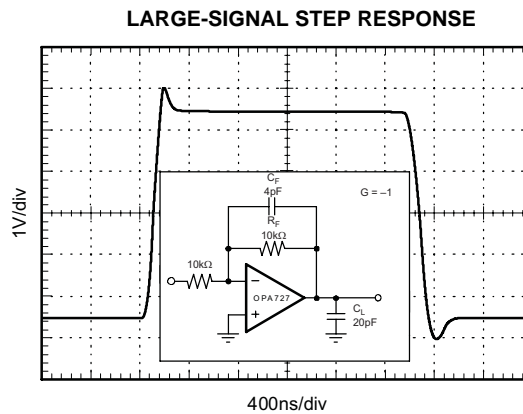

Figure 27.

APPLICATIONS INFORMATION

The OPA727 and OPA728 family of op amps use *e-trim*, an adjustment to offset voltage and temperature drift made during the final steps of manufacturing after the plastic molding is completed. This compensates for performance shifts that can occur during the molding process. Through *e-trim*, the OPA727 and OPA728 deliver excellent offset voltage (150 μ V max) and extremely low offset voltage drift (1.5 μ V/ $^{\circ}$ C). Additionally, these 20MHz CMOS op amps have a fast slew rate, low noise, and excellent PSRR, CMRR, and A_{OL} . They can operate on typically 4.3mA quiescent current from a single (or split) supply in the range of 4V to 12V (\pm 2V to \pm 6V), making them highly versatile and easy to use. They are stable in a unity-gain configuration.

Power-supply pins should be bypassed with 1nF ceramic capacitors in parallel with 1 μ F tantalum capacitors.

OPERATING VOLTAGE

OPA727 series op amps are specified from 4V to 12V supplies over a temperature range of -40° C to $+125^{\circ}$ C. They will operate well in \pm 5V or +5V to +12V power-supply systems. Parameters that vary significantly with operating voltage or temperature are shown in the Typical Characteristics.

ENABLE/SHUTDOWN

OPA727 series op amps require approximately 4.3mA quiescent current. The enable/shutdown feature of the OPA728 allows the op amp to be shut off to reduce this current to approximately 6 μ A.

The enable/shutdown input is referenced to the Enable Reference Pin, REF (see [Pin Configurations](#)). This pin can be connected to logic ground in dual-supply op amp configurations to avoid level-shifting the enable logic signal, as shown in [Figure 28](#).

The Enable Reference Pin voltage, V_{REF} , must not exceed $(V+) - 2V$. It may be set as low as $V-$. The amplifier is enabled when the Enable Pin voltage is greater than $V_{REF} + 2V$. The amplifier is disabled (shutdown) if the Enable Pin voltage is less than $V_{REF} + 0.8V$. The Enable Pin is connected to internal pull-up circuitry and will enable the device if left unconnected.

COMMON-MODE VOLTAGE RANGE

The input common-mode voltage range of the OPA727 and OPA728 series extends from $V-$ to $(V+) - 2.5V$.

Common-mode rejection is excellent throughout the input voltage range from $V-$ to $(V+) - 3V$. CMRR decreases somewhat as the common-mode voltage extends to $(V+) - 2.5V$, but remains very good and is tested throughout this range. See the [Electrical Characteristics](#) table for details.

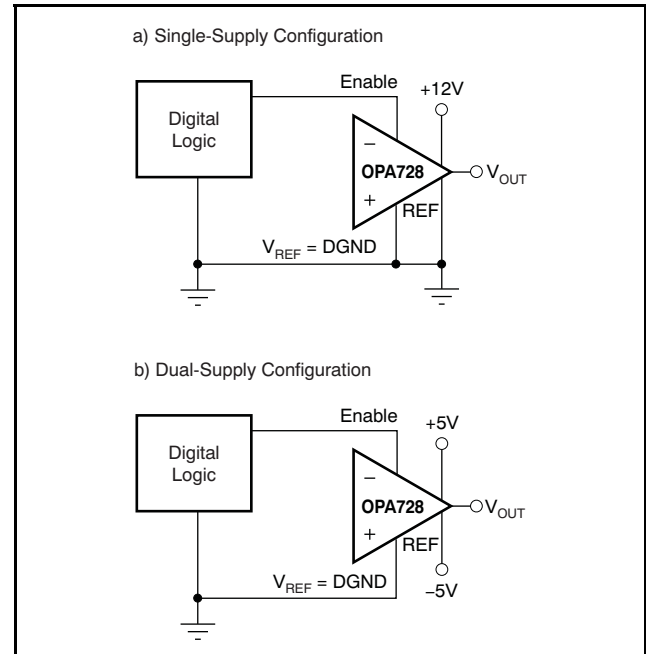

Figure 28. Enable Reference Pin Connection for Single- and Dual-Supply Configurations

INPUT OVER-VOLTAGE PROTECTION

Device inputs are protected by ESD diodes that will conduct if the input voltages exceed the power supplies by more than approximately 300mV. Momentary voltages greater than 300mV beyond the power supply can be tolerated if the current is limited to 10mA. This is easily accomplished with an input resistor in series with the op amp, as shown in [Figure 29](#). The OPA727 series features no phase inversion when the inputs extend beyond supplies, if the input is current limited.

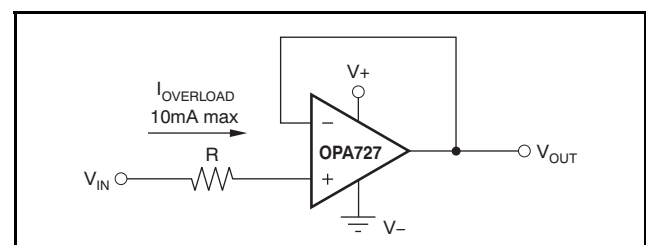

Figure 29. Input Current Protection for Voltages Exceeding the Supply Voltage

RAIL-TO-RAIL OUTPUT

A class AB output stage with common-source transistors is used to achieve rail-to-rail output. This output stage is capable of driving heavy loads connected to any point between V+ and V-. For light resistive loads (>100k Ω), the output voltage can swing to 150mV from the supply rail, while still maintaining excellent linearity ($A_{OL} > 110\text{dB}$). With 1k Ω resistive loads, the output is specified to swing to within 250mV from the supply rails with excellent linearity (see the Typical Characteristics curve, [Output Voltage Swing vs Output Current](#)).

CAPACITIVE LOAD AND STABILITY

Capacitive load drive is dependent upon gain and the overshoot requirements of the application. Increasing the gain enhances the ability of the amplifier to drive greater capacitive loads (see the Typical Characteristics curve, [Small-Signal Overshoot vs Capacitive Load](#)).

One method of improving capacitive load drive in the unity-gain configuration is to insert a 10 Ω to 20 Ω resistor inside the feedback loop, as shown in [Figure 30](#). This reduces ringing with large capacitive loads while maintaining DC accuracy.

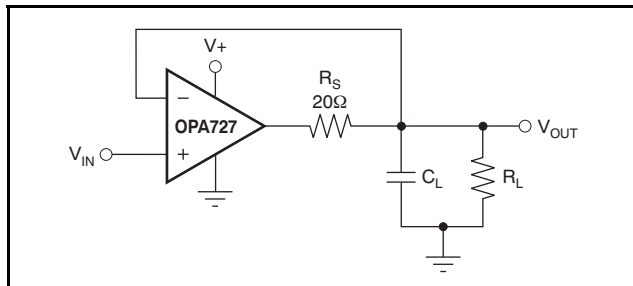

Figure 30. Series Resistor in Unity-Gain Buffer Configuration Improves Capacitive Load Drive

DRIVING FAST 16-BIT ADCs

The OPA727 series is optimized for driving fast 16-bit ADCs such as the [ADS8342](#). The OPA727 op amps buffer the converter input capacitance and resulting charge injection, while providing signal gain. [Figure 31](#) shows the OPA727 in a single-ended method of interfacing to the ADS8342 16-bit, 250kSPS, 4-channel ADC with an input range of $\pm 2.5\text{V}$. The OPA727 has demonstrated excellent settling time to the 16-bit level within the 600ns acquisition time of the ADS8342. The RC filter, shown in [Figure 31](#), has been carefully tuned for best noise and settling performance. It may need to be adjusted for different op amp configurations. Refer to the [ADS8342 data sheet](#) (available for download at www.ti.com) for additional information on this product.

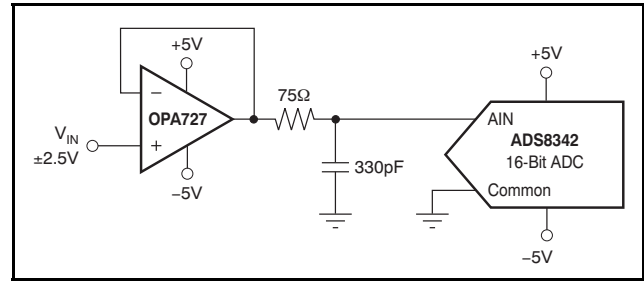

Figure 31. OPA727 Driving an ADC

TRANSIMPEDANCE AMPLIFIER

Wide bandwidth, low input bias current, and low input voltage and current noise make the OPA727 an ideal wideband photodiode transimpedance amplifier. Low-voltage noise is important because photodiode capacitance causes the effective noise gain of the circuit to increase at high frequency.

The key elements to a transimpedance design, as shown in [Figure 32](#), are the expected diode capacitance (C_D), which should include the parasitic input common-mode and differential-mode input capacitance (4pF + 5pF for the OPA727); the desired transimpedance gain (R_F); and the GBW for the OPA727 (20MHz). With these three variables set, the feedback capacitor value (C_F) can be set to control the frequency response. C_F includes the stray capacitance of R_F , which is 0.2pF for a typical surface-mount resistor.

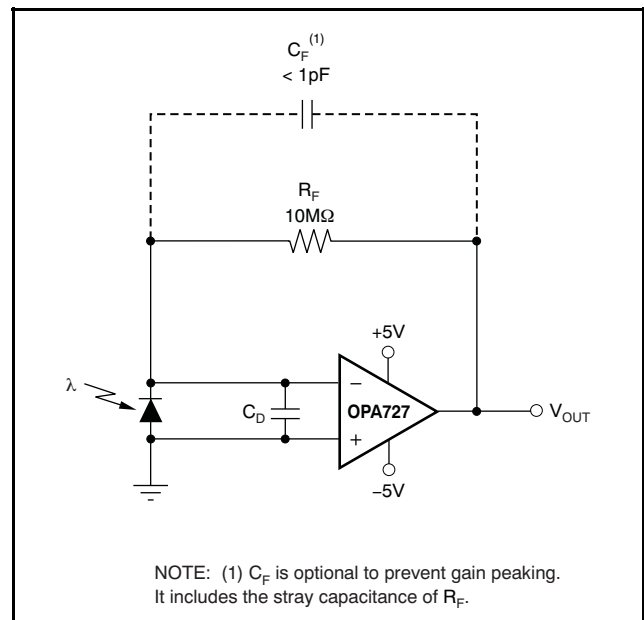

Figure 32. Dual-Supply Transimpedance Amplifier

To achieve a maximally-flat, 2nd-order Butterworth frequency response, the feedback pole should be set to:

$$\frac{1}{2\pi R_F C_F} = \sqrt{\frac{GBW}{4\pi R_F C_D}} \quad (1)$$

Bandwidth is calculated by:

$$f_{-3dB} = \sqrt{\frac{GBW}{2\pi R_F C_D}} \text{ Hz} \quad (2)$$

For even higher transimpedance bandwidth, the high-speed CMOS [OPA380](#) (90MHz GBW), [OPA354](#) (100MHz GBW), [OPA300](#) (180MHz GBW), [OPA355](#) (200MHz GBW), or [OPA656](#), [OPA657](#) (400MHz GBW) may be used.

For single-supply applications, the +IN input can be biased with a positive dc voltage to allow the output to reach true zero when the photodiode is not exposed to any light, and respond without the added delay that results from coming out of the negative rail; this is shown in [Figure 33](#). This bias voltage also appears across the photodiode, providing a reverse bias for faster operation.

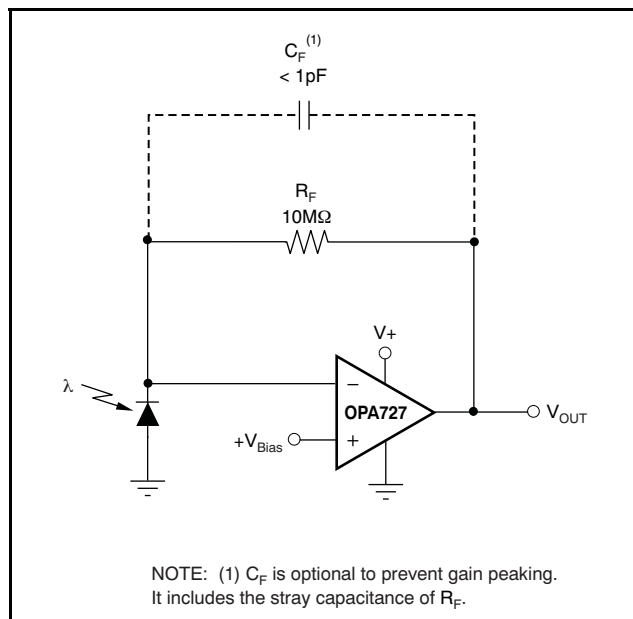

Figure 33. Single-Supply Transimpedance Amplifier

For additional information, refer to Application Bulletin ([SBOA055](#)), *Compensate Transimpedance Amplifiers Intuitively*, available for download at www.ti.com.

OPTIMIZING THE TRANSIMPEDANCE CIRCUIT

To achieve the best performance, components should be selected according to the following guidelines:

1. For lowest noise, select R_F to create the total required gain. Using a lower value for R_F and adding gain after the transimpedance amplifier generally produces poorer noise performance. The noise produced by R_F increases with the square-root of R_F, whereas the signal increases linearly. Therefore, signal-to-noise ratio is improved when all the required gain is placed in the transimpedance stage.
2. Minimize photodiode capacitance and stray capacitance at the summing junction (inverting input). This capacitance causes the voltage noise of the op amp to be amplified (increasing amplification at high frequency). Using a low-noise voltage source to reverse-bias a photodiode can significantly reduce its capacitance. Smaller photodiodes have lower capacitance. Use optics to concentrate light on a small photodiode.
3. Noise increases with increased bandwidth. Limit the circuit bandwidth to only that required. Use a capacitor across the R_F to limit bandwidth, even if not required for stability.
4. Circuit board leakage can degrade the performance of an otherwise well-designed amplifier. Clean the circuit board carefully. A circuit board guard trace that encircles the summing junction and is driven at the same voltage can help control leakage.

For additional information, refer to the Application Bulletins *Noise Analysis of FET Transimpedance Amplifiers* ([SBOA060](#)), and *Noise Analysis for High-Speed Op Amps* ([SBOA066](#)), available for download at the TI web site.

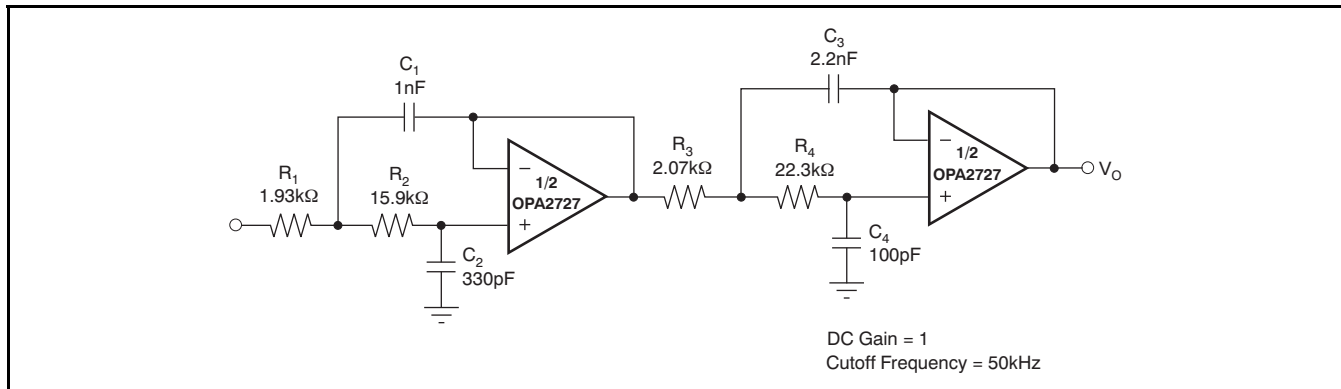

Note: FilterPro is a low-pass filter design program available for download at no cost from TI's web site (www.ti.com). The program can be used to determine component values for other cutoff frequencies or filter types.

Figure 34. Four-Pole Butterworth Sallen-Key Low-Pass Filter

DFN PACKAGE

The OPA727 series uses the DFN-8 (also known as SON), which is a QFN package with lead contacts on only two sides of the bottom of the package. This leadless, near-chip-scale package maximizes board space and enhances thermal and electrical characteristics through an exposed pad.

DFN packages are physically small, have a smaller routing area, improved thermal performance, and improved electrical parasitics, with a pinout scheme that is consistent with other commonly-used packages, such as SO and MSOP. Additionally, the absence of external leads eliminates bent-lead issues.

The DFN package can be easily mounted using standard printed circuit board (PCB) assembly techniques. See Application Note, *QFN/SO/SON PCB Attachment (SLUA271)* and Application Report, *Quad Flatpack No-Lead Logic Packages (SCBA017)*, both available for download at www.ti.com.

The exposed leadframe die pad on the bottom of the package should be connected to V–.

LAYOUT GUIDELINES

The leadframe die pad should be soldered to a thermal pad on the PCB. A mechanical data sheet showing an example layout is attached at the end of this data sheet. Refinements to this layout may be required based on assembly process requirements. Mechanical drawings located at the end of this data sheet list the physical dimensions for the package and pad. The five holes in the landing pattern are optional, and are intended for use with thermal vias that connect the leadframe die pad to the heatsink area on the PCB.

Soldering the exposed pad significantly improves board-level reliability during temperature cycling, key push, package shear, and similar board-level tests. Even with applications that have low-power dissipation, the exposed pad must be soldered to the PCB to provide structural integrity and long-term reliability.

PACKAGING INFORMATION

Orderable Device	Status (1)	Package Type	Package Drawing	Pins	Package Qty	Eco Plan (2)	Lead/Ball Finish (6)	MSL Peak Temp (3)	Op Temp (°C)	Device Marking (4/5)	Samples
OPA2727AID	ACTIVE	SOIC	D	8	75	Green (RoHS & no Sb/Br)	CU NIPDAU	Level-3-260C-168 HR	-40 to 85	O2727A 2727A	Samples
OPA2727AIDR	ACTIVE	SOIC	D	8	2500	Green (RoHS & no Sb/Br)	CU NIPDAU	Level-3-260C-168 HR	-40 to 85	O2727A 2727A	Samples
OPA2727AIDRBR	ACTIVE	SON	DRB	8	2500	Green (RoHS & no Sb/Br)	CU NIPDAU	Level-3-260C-168 HR	-40 to 85	NSD	Samples
OPA2727AIDRBT	ACTIVE	SON	DRB	8	250	Green (RoHS & no Sb/Br)	CU NIPDAU	Level-3-260C-168 HR	-40 to 85	NSD	Samples
OPA4727AIPW	ACTIVE	TSSOP	PW	14	90	Green (RoHS & no Sb/Br)	CU NIPDAU	Level-2-260C-1 YEAR	-40 to 85	OPA4727	Samples
OPA4727AIPWR	ACTIVE	TSSOP	PW	14	2000	Green (RoHS & no Sb/Br)	CU NIPDAU	Level-2-260C-1 YEAR	-40 to 85	OPA4727	Samples
OPA727AIDGKR	ACTIVE	VSSOP	DGK	8	2500	Green (RoHS & no Sb/Br)	CU NIPDAU Call TI	Level-2-260C-1 YEAR	-40 to 85	AUE	Samples
OPA727AIDGKRG4	ACTIVE	VSSOP	DGK	8	2500	Green (RoHS & no Sb/Br)	Call TI	Level-2-260C-1 YEAR	-40 to 85	AUE	Samples
OPA727AIDGKT	ACTIVE	VSSOP	DGK	8	250	Green (RoHS & no Sb/Br)	CU NIPDAU Call TI	Level-2-260C-1 YEAR	-40 to 85	AUE	Samples
OPA727AIDRBT	ACTIVE	SON	DRB	8	250	Green (RoHS & no Sb/Br)	CU NIPDAU	Level-2-260C-1 YEAR	-40 to 85	NSF	Samples
OPA727AIDRBTG4	ACTIVE	SON	DRB	8	250	Green (RoHS & no Sb/Br)	CU NIPDAU	Level-2-260C-1 YEAR	-40 to 85	NSF	Samples
OPA728AIDGKT	ACTIVE	VSSOP	DGK	8	250	Green (RoHS & no Sb/Br)	CU NIPDAUAG	Level-2-260C-1 YEAR	-40 to 125	AUF	Samples
OPA728AIDRBT	ACTIVE	SON	DRB	8	250	Green (RoHS & no Sb/Br)	CU NIPDAU	Level-2-260C-1 YEAR	-40 to 125	NSG	Samples

(1) The marketing status values are defined as follows:

ACTIVE: Product device recommended for new designs.

LIFEBUY: TI has announced that the device will be discontinued, and a lifetime-buy period is in effect.

NRND: Not recommended for new designs. Device is in production to support existing customers, but TI does not recommend using this part in a new design.

PREVIEW: Device has been announced but is not in production. Samples may or may not be available.

OBSOLETE: TI has discontinued the production of the device.

(2) **RoHS:** TI defines "RoHS" to mean semiconductor products that are compliant with the current EU RoHS requirements for all 10 RoHS substances, including the requirement that RoHS substance do not exceed 0.1% by weight in homogeneous materials. Where designed to be soldered at high temperatures, "RoHS" products are suitable for use in specified lead-free processes. TI may reference these types of products as "Pb-Free".

RoHS Exempt: TI defines "RoHS Exempt" to mean products that contain lead but are compliant with EU RoHS pursuant to a specific EU RoHS exemption.

Green: TI defines "Green" to mean the content of Chlorine (Cl) and Bromine (Br) based flame retardants meet JS709B low halogen requirements of ≤ 1000 ppm threshold. Antimony trioxide based flame retardants must also meet the ≤ 1000 ppm threshold requirement.

(3) MSL, Peak Temp. - The Moisture Sensitivity Level rating according to the JEDEC industry standard classifications, and peak solder temperature.

(4) There may be additional marking, which relates to the logo, the lot trace code information, or the environmental category on the device.

(5) Multiple Device Markings will be inside parentheses. Only one Device Marking contained in parentheses and separated by a "~" will appear on a device. If a line is indented then it is a continuation of the previous line and the two combined represent the entire Device Marking for that device.

(6) Lead/Ball Finish - Orderable Devices may have multiple material finish options. Finish options are separated by a vertical ruled line. Lead/Ball Finish values may wrap to two lines if the finish value exceeds the maximum column width.

Important Information and Disclaimer: The information provided on this page represents TI's knowledge and belief as of the date that it is provided. TI bases its knowledge and belief on information provided by third parties, and makes no representation or warranty as to the accuracy of such information. Efforts are underway to better integrate information from third parties. TI has taken and continues to take reasonable steps to provide representative and accurate information but may not have conducted destructive testing or chemical analysis on incoming materials and chemicals. TI and TI suppliers consider certain information to be proprietary, and thus CAS numbers and other limited information may not be available for release.

In no event shall TI's liability arising out of such information exceed the total purchase price of the TI part(s) at issue in this document sold by TI to Customer on an annual basis.

TAPE AND REEL INFORMATION

QUADRANT ASSIGNMENTS FOR PIN 1 ORIENTATION IN TAPE

*All dimensions are nominal

Device	Package Type	Package Drawing	Pins	SPQ	Reel Diameter (mm)	Reel Width W1 (mm)	A0 (mm)	B0 (mm)	K0 (mm)	P1 (mm)	W (mm)	Pin1 Quadrant
OPA2727AIDR	SOIC	D	8	2500	330.0	12.4	6.4	5.2	2.1	8.0	12.0	Q1
OPA2727AIDRBR	SON	DRB	8	2500	330.0	12.4	3.3	3.3	1.1	8.0	12.0	Q2
OPA2727AIDRBT	SON	DRB	8	250	180.0	12.4	3.3	3.3	1.1	8.0	12.0	Q2
OPA4727AIPWR	TSSOP	PW	14	2000	330.0	12.4	6.9	5.6	1.6	8.0	12.0	Q1
OPA727AIDGKR	VSSOP	DGK	8	2500	330.0	12.4	5.3	3.4	1.4	8.0	12.0	Q1
OPA727AIDGKT	VSSOP	DGK	8	250	180.0	12.4	5.3	3.4	1.4	8.0	12.0	Q1
OPA727AIDRBT	SON	DRB	8	250	180.0	12.4	3.3	3.3	1.1	8.0	12.0	Q2
OPA728AIDGKT	VSSOP	DGK	8	250	180.0	12.4	5.3	3.4	1.4	8.0	12.0	Q1
OPA728AIDRBT	SON	DRB	8	250	180.0	12.4	3.3	3.3	1.1	8.0	12.0	Q2

TAPE AND REEL BOX DIMENSIONS

*All dimensions are nominal

Device	Package Type	Package Drawing	Pins	SPQ	Length (mm)	Width (mm)	Height (mm)
OPA2727AIDR	SOIC	D	8	2500	367.0	367.0	35.0
OPA2727AIDRBR	SON	DRB	8	2500	367.0	367.0	35.0
OPA2727AIDRBT	SON	DRB	8	250	210.0	185.0	35.0
OPA4727AIPWR	TSSOP	PW	14	2000	367.0	367.0	35.0
OPA727AIDGKR	VSSOP	DGK	8	2500	367.0	367.0	35.0
OPA727AIDGKT	VSSOP	DGK	8	250	210.0	185.0	35.0
OPA727AIDRBT	SON	DRB	8	250	210.0	185.0	35.0
OPA728AIDGKT	VSSOP	DGK	8	250	210.0	185.0	35.0
OPA728AIDRBT	SON	DRB	8	250	210.0	185.0	35.0

DRB 8

GENERIC PACKAGE VIEW

VSON - 1 mm max height

PLASTIC SMALL OUTLINE - NO LEAD

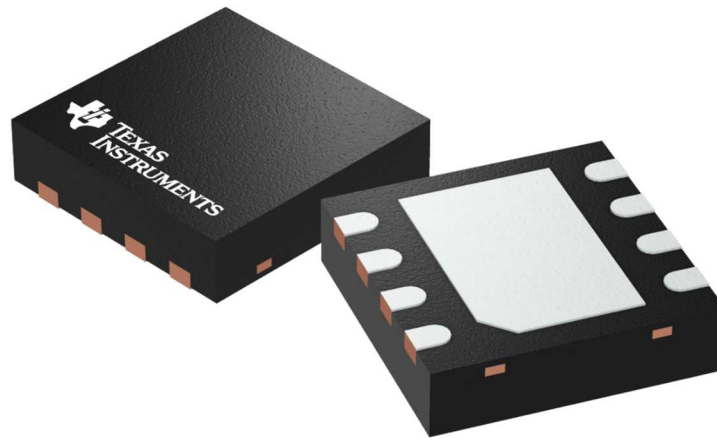

Images above are just a representation of the package family, actual package may vary.
Refer to the product data sheet for package details.

4203482/L

DRB0008B

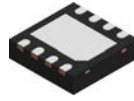

PACKAGE OUTLINE

VSON - 1 mm max height

PLASTIC SMALL OUTLINE - NO LEAD

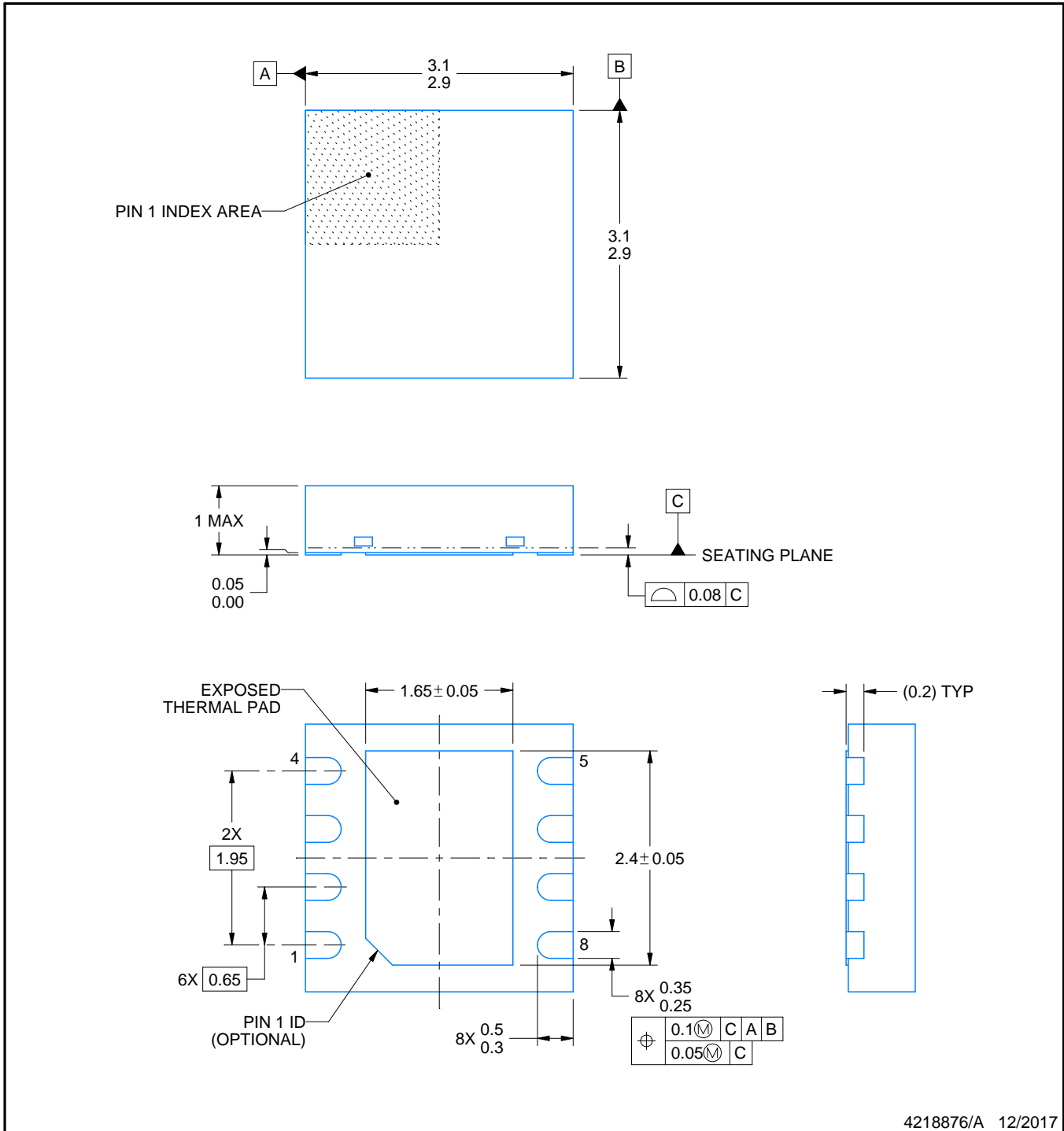

4218876/A 12/2017

NOTES:

1. All linear dimensions are in millimeters. Any dimensions in parenthesis are for reference only. Dimensioning and tolerancing per ASME Y14.5M.
2. This drawing is subject to change without notice.
3. The package thermal pad must be soldered to the printed circuit board for thermal and mechanical performance.

EXAMPLE STENCIL DESIGN

DRB0008B

VSON - 1 mm max height

PLASTIC SMALL OUTLINE - NO LEAD

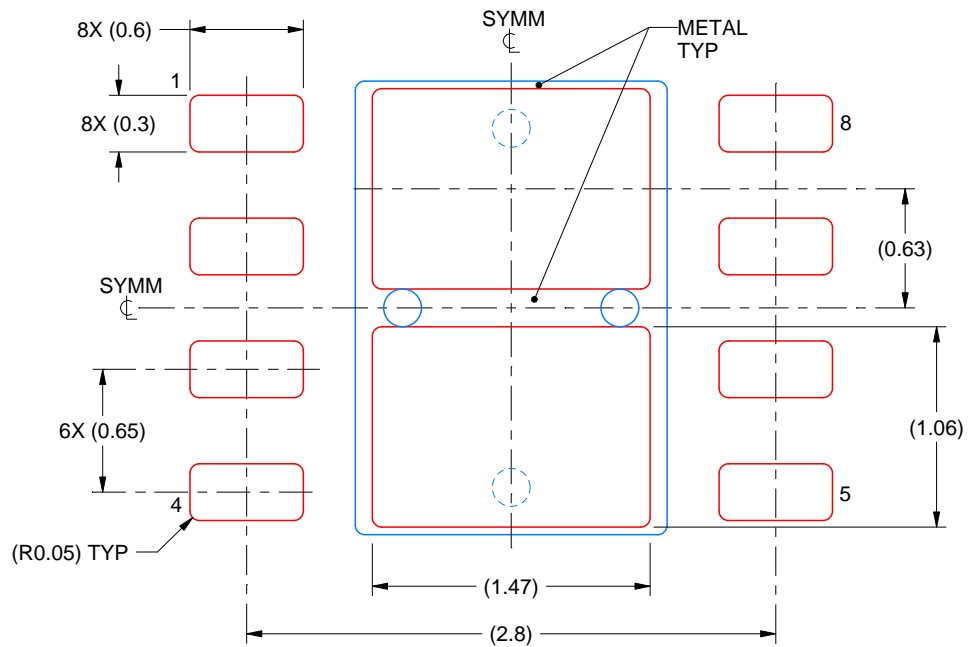

SOLDER PASTE EXAMPLE
BASED ON 0.125 mm THICK STENCIL

EXPOSED PAD
81% PRINTED SOLDER COVERAGE BY AREA
SCALE:25X

4218876/A 12/2017

NOTES: (continued)

6. Laser cutting apertures with trapezoidal walls and rounded corners may offer better paste release. IPC-7525 may have alternate design recommendations.



- NOTES:
- A. All linear dimensions are in millimeters.
 - B. This drawing is subject to change without notice.
 - C. Publication IPC-7351 is recommended for alternate designs.
 - D. Laser cutting apertures with trapezoidal walls and also rounding corners will offer better paste release. Customers should contact their board assembly site for stencil design recommendations. Refer to IPC-7525 for other stencil recommendations.
 - E. Customers should contact their board fabrication site for solder mask tolerances between and around signal pads.

PW (R-PDSO-G14)

PLASTIC SMALL OUTLINE



4211284-2/G 08/15

- NOTES:
- A. All linear dimensions are in millimeters.
 - B. This drawing is subject to change without notice.
 - C. Publication IPC-7351 is recommended for alternate designs.
 - D. Laser cutting apertures with trapezoidal walls and also rounding corners will offer better paste release. Customers should contact their board assembly site for stencil design recommendations. Refer to IPC-7525 for other stencil recommendations.
 - E. Customers should contact their board fabrication site for solder mask tolerances between and around signal pads.



D0008A

PACKAGE OUTLINE

SOIC - 1.75 mm max height

SMALL OUTLINE INTEGRATED CIRCUIT



4214825/C 02/2019

NOTES:

1. Linear dimensions are in inches [millimeters]. Dimensions in parenthesis are for reference only. Controlling dimensions are in inches. Dimensioning and tolerancing per ASME Y14.5M.
2. This drawing is subject to change without notice.
3. This dimension does not include mold flash, protrusions, or gate burrs. Mold flash, protrusions, or gate burrs shall not exceed $.006$ [0.15] per side.
4. This dimension does not include interlead flash.
5. Reference JEDEC registration MS-012, variation AA.

EXAMPLE BOARD LAYOUT

D0008A

SOIC - 1.75 mm max height

SMALL OUTLINE INTEGRATED CIRCUIT



LAND PATTERN EXAMPLE
 EXPOSED METAL SHOWN
 SCALE:8X



SOLDER MASK DETAILS

4214825/C 02/2019

NOTES: (continued)

- 6. Publication IPC-7351 may have alternate designs.
- 7. Solder mask tolerances between and around signal pads can vary based on board fabrication site.

EXAMPLE STENCIL DESIGN

D0008A

SOIC - 1.75 mm max height

SMALL OUTLINE INTEGRATED CIRCUIT



SOLDER PASTE EXAMPLE
BASED ON .005 INCH [0.125 MM] THICK STENCIL
SCALE:8X

4214825/C 02/2019

NOTES: (continued)

8. Laser cutting apertures with trapezoidal walls and rounded corners may offer better paste release. IPC-7525 may have alternate design recommendations.
9. Board assembly site may have different recommendations for stencil design.

IMPORTANT NOTICE AND DISCLAIMER

TI PROVIDES TECHNICAL AND RELIABILITY DATA (INCLUDING DATASHEETS), DESIGN RESOURCES (INCLUDING REFERENCE DESIGNS), APPLICATION OR OTHER DESIGN ADVICE, WEB TOOLS, SAFETY INFORMATION, AND OTHER RESOURCES "AS IS" AND WITH ALL FAULTS, AND DISCLAIMS ALL WARRANTIES, EXPRESS AND IMPLIED, INCLUDING WITHOUT LIMITATION ANY IMPLIED WARRANTIES OF MERCHANTABILITY, FITNESS FOR A PARTICULAR PURPOSE OR NON-INFRINGEMENT OF THIRD PARTY INTELLECTUAL PROPERTY RIGHTS.

These resources are intended for skilled developers designing with TI products. You are solely responsible for (1) selecting the appropriate TI products for your application, (2) designing, validating and testing your application, and (3) ensuring your application meets applicable standards, and any other safety, security, or other requirements. These resources are subject to change without notice. TI grants you permission to use these resources only for development of an application that uses the TI products described in the resource. Other reproduction and display of these resources is prohibited. No license is granted to any other TI intellectual property right or to any third party intellectual property right. TI disclaims responsibility for, and you will fully indemnify TI and its representatives against, any claims, damages, costs, losses, and liabilities arising out of your use of these resources.

TI's products are provided subject to TI's Terms of Sale (www.ti.com/legal/termsofsale.html) or other applicable terms available either on ti.com or provided in conjunction with such TI products. TI's provision of these resources does not expand or otherwise alter TI's applicable warranties or warranty disclaimers for TI products.

Mailing Address: Texas Instruments, Post Office Box 655303, Dallas, Texas 75265
Copyright © 2019, Texas Instruments Incorporated

Looking for pricing, stock, or lifecycle information?

Click below to explore more details on WIN SOURCE:

 [View OPA728AIDRBT on WIN SOURCE](#)

 [Texas Instruments](#) Information

Optimize Your Supply Chain with WIN SOURCE Solutions

-  Global Sourcing Solution
-  Obsolete Management
-  Cost Control Management
-  Shortage Management
-  Alternative Solution
-  Excess Inventory Management