



**THE DATASHEET OF
MC145010DW**



Photoelectric Smoke Detector IC with I/O

The CMOS MC145010 is an advanced smoke detector component containing sophisticated very-low-power analog and digital circuitry. The IC is used with an infrared photoelectric chamber. Detection is accomplished by sensing scattered light from minute smoke particles or other aerosols. When detection occurs, a pulsating alarm is sounded via on-chip push-pull drivers and an external piezoelectric transducer.

The variable-gain photo amplifier allows direct interface to IR detectors (photodiodes). Two external capacitors, C1 and C2, C1 being the larger, determine the gain settings. Low gain is selected by the IC during most of the standby state. Medium gain is selected during a local-smoke condition. High gain is used during push button test. During standby, the special monitor circuit which periodically checks for degraded chamber sensitivity uses high gain, also.

The I/O pin, in combination with V_{SS} , can be used to interconnect up to 40 units for common signaling. An on-chip current sink provides noise immunity when the I/O is an input. A local-smoke condition activates the short-circuit-protected I/O driver, thereby signaling remote smoke to the interconnected units. Additionally, the I/O pin can be used to activate escape lights, enable auxiliary or remote alarms, and/or initiate auto-dialers.

While in standby, the low-supply detection circuitry conducts periodic checks using a pulsed load current from the LED pin. The trip point is set using two external resistors. The supply for the MC145010 can be a 9 V battery.

A visible LED flash accompanying a pulsating audible alarm indicates a local-smoke condition. A pulsating audible alarm with no LED flash indicates a remote-smoke condition. A beep or chirp occurring virtually simultaneously with an LED flash indicates a low-supply condition. A beep occurring half-way between LED flashes indicates degraded chamber sensitivity. A low-supply condition does not affect the smoke detection capability if $V_{DD} \geq 6$ V. Therefore, the low-supply condition and degraded chamber sensitivity can be further distinguished by performing a push button (chamber) test.

Features

- Circuit is designed to operate in smoke detector systems that comply with UL217 and UL268 Specifications
- Operating Voltage Range: 6 to 12 V
- Operating Temperature Range: - 10 to 60°C
- Average Supply Current: 12 μ A
- Power-On Reset Places IC in Standby Mode (Non-Alarm State)
- Electrostatic Discharge (ESD) and Latch Up Protection Circuitry on All Pins
- Chip Complexity: 2000 FETs, 12 NPNs, 16 Resistors, and 10 Capacitors
- Ideal for battery powered applications.

ORDERING INFORMATION			
Device	Temp. Range	Case No.	Package
MC145010P	-55 to +125°C	648-08	16 Lead Plastic Dip
MC145010ED			
MC145010DW		751G-04	16 Lead SOICW
MCZ145010EG/EGR2			

MC145010

**PHOTOELECTRIC SMOKE
DETECTOR IC WITH I/O**

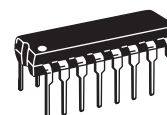

**P SUFFIX
ED SUFFIX (PB-FREE)
PLASTIC DIP
CASE 648-08**

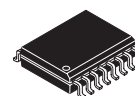

**DW SUFFIX
EG SUFFIX (PB-FREE)
SOICW
CASE 751G-04**

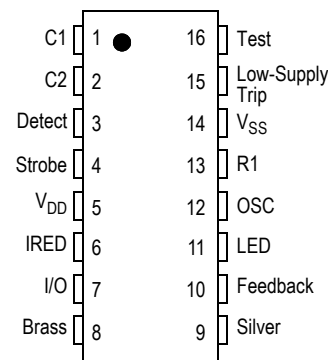

Figure 1. Pin Connections

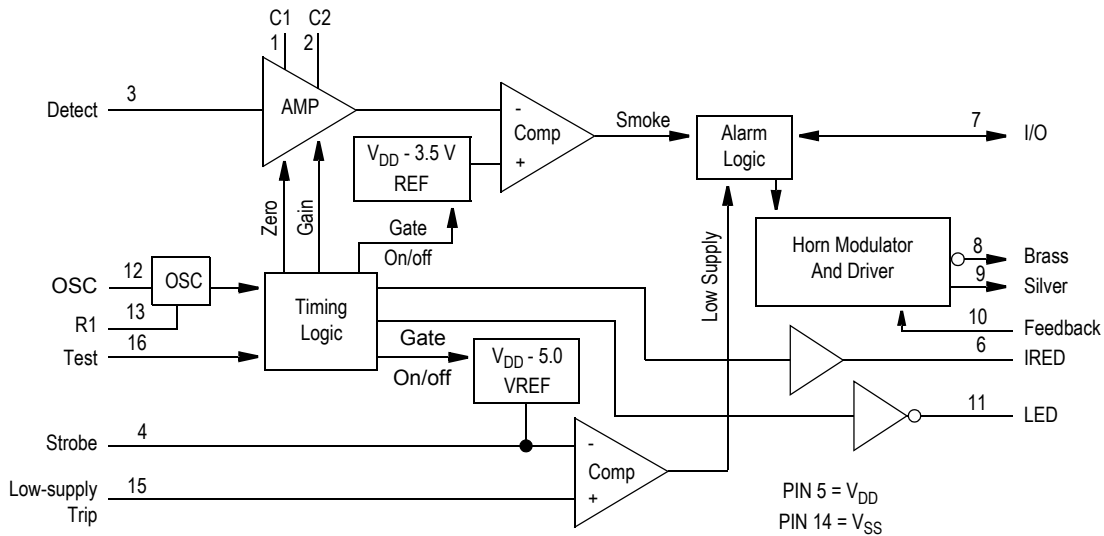

Figure 2. Block Diagram

Table 1. Maximum Ratings⁽¹⁾
(Voltages referenced to V_{SS})

Rating	Symbol	Value	Unit
DC Supply Voltage	V _{DD}	-0.5 to +15	V
DC Input Voltage C1, C2, Detect OSC, Low-Supply Trip I/O Feedback Test	V _{IN}	-0.25 to V _{DD} +0.25 -0.25 to V _{DD} +0.25 -0.25 to V _{DD} +10 -15 to +25 -1.0 to V _{DD} +0.25	V
DC Input Current per Pin	I _{IN}	±10	mA
DC Output Current per Pin	I _{OUT}	±25	mA
DC Supply Current, VDD and VSS Pins	I _{DD}	+25 / -150	mA
Power Dissipation in Still Air 5 Seconds Continuous	P _D	1200 ⁽²⁾ 350 ⁽³⁾	mW
Storage Temperature Range	T _{STG}	-55 to +125	°C
Lead Temperature, 1 mm From Case for 10 Seconds	T _L	5.0	°C

1. Maximum Ratings are those values beyond which damage to the device may occur. Functional operation should be restricted to the limits in the Electrical Characteristics tables.
2. Derating: -12 mW/°C from 25° to 60°C.
3. Derating -3.5 mW/°C from 25° to 60°C.

This device contains circuitry to protect the inputs against damage due to high static voltages or electric fields; however, it is advised normal precautions be taken to avoid application of any voltage higher than maximum rated voltages to this high impedance circuit. For proper operation, it is recommended V_{IN} and V_{OUT} be constrained to the range V_{SS} ≤ (V_{IN} or V_{OUT}) ≤ V_{DD}.

Table 2. Electrical Characteristics

 ($T_A = -10$ to 60°C unless otherwise indicated. Voltages referenced to V_{SS} .)

Characteristics	Symbol	V_{DD}/V_{DC}	Min	Typ	Max	Unit
Operating Voltage	V_{DD}	—	6.0	—	12.0	V
Supply Threshold voltage, Low-Supply Alarm Low-Supply Trip: $V_{IN} = V_{DD}/3$	V_{TH}	—	6.5	—	7.8	V
Average Operating Supply Current (per Package) Standby Configured per Figure 8	I_{DD}	12.0	—	—	12.0	μA
Peak Supply Current (per Package) During Strobe ON, IRED OFF Configured per Figure 8 During Strobe ON, IRED ON Configured per Figure 8	i_{DD}	12.0 12.0	— —	— —	2.0 3.0	mA
Low-Level Input Voltage I/O Feedback Test	V_{IL}	9.0 9.0 9.0	— — —	— — —	1.5 2.7 7.0	V
High-Level Input Voltage I/O Feedback Test	V_{IH}	9.0 9.0 9.0	3.2 6.3 8.5	— — —	— — —	V
Input Current OSC, Detect – $V_{IN} = V_{SS}$ or V_{DD} Low-Supply Trip – $V_{IN} = V_{SS}$ or V_{DD} Feedback – $V_{IN} = V_{SS}$ or V_{DD}	I_{IN}	12.0 12.0 12.0	— — —	— — —	± 100 ± 100 ± 100	nA
Low-Level Input Current Test – $V_{IN} = V_{SS}$ or V_{DD}	I_{IL}	12.0	—	—	-1.0	μA
Pull-Down Current Test – $V_{IN} = V_{DD}$ I/O – No Local Smoke, $V_{IN} = V_{DD}$ I/O – No Local Smoke, $V_{IN} = 17\text{ V}$	I_{IH}	9.0 9.0 12.0	0.5 25.0 —	— — —	10 100 140	μA
Low-Level Output Voltage LED – $I_{OUT} = 10\text{ mA}$ Silver, Brass – $I_{OUT} = 16\text{ mA}$	V_{OL}	6.5 6.5	— —	— —	0.6 1.0	V
High-Level Output Voltage Silver, Brass – $I_{OUT} = 16\text{ mA}$	V_{OH}	6.5	5.5	—	—	V
Output Voltage (For Line Regulations, See Pin Descriptions) Strobe – Inactive, $I_{OUT} = -1\ \mu\text{A}$ Active, $I_{OUT} = 100\ \mu\text{A}$ to $500\ \mu\text{A}$ (Load Regulation) IRED – Inactive, $I_{OUT} = 1\ \mu\text{A}$ Active, $I_{OUT} = 6\ \mu\text{A}$ (Load Regulation)	V_{OUT}	— 9.0 — 9.0	$V_{DD} - 0.1$ $V_{DD} - 4.40$ — $2.25^{(1)}$	— — — —	— $V_{DD} - 5.30$ 0.1 3.75^1	V
High-Level Output Current I/O – Local Smoke, $V_{OUT} = 4.5\text{ V}$ I/O – Local Smoke, $V_{OUT} = V_{SS}$ (Short Circuit Current)	I_{OH}	6.5 12.0	-4 —	— —	— -16	mA
Off-State Output Leakage Current LED – $V_{OUT} = V_{SS}$ or V_{DD}	I_{OZ}	12.0	—	—	± 1.0	$\times\text{A}$
Common Mode C1, C2, Detect, Voltage Range – Local Smoke, Push Button Test, or Chamber Sensitivity Test	V_{IC}	—	$V_{DD} - 4$	—	$V_{DD} - 2$	V
Smoke Comparator Internal Reference Voltage – Local Smoke, Push Button Test, or Chamber Sensitivity Test	V_{REF}	—	$V_{DD} - 3.08$	—	$V_{DD} - 3.92$	V

 1. $T_A = 25^\circ\text{C}$ only.

Table 3. AC Electrical Characteristics

Reference Timing Diagram [Figure 6](#) and [Figure 7](#). ($T_A = 25^\circ\text{C}$, $V_{DD} = 9.0\text{ V}$, Component values from [Figure 8](#): $R_1 = 100.0\text{ K}\Omega$, $C_3 = 1500.0\text{ pF}$, $R_2 = 10.0\text{ M}\Omega$.)

No.	Characteristics	Symbol	Clocks	Min	Max	Unit
1	Oscillator Period ⁽¹⁾ Free-Running Sawtooth Measured at Pin 12	$1/f_{OSC}$	1	9.5	11.5	ms
2	LED Pulse Period No Local Smoke, and No Remote Smoke	t_{LED}	4096	38.9	47.1	s
3	Remote Smoke, but No Local Smoke		—	—	—	
4	Local Smoke or Push Button Test		64	0.60	0.74	
5	LED Pulse Width and Strobe Pulse Width	$t_{w(LED)}$, $t_{w(STB)}$	1	9.5	11.5	ms
6	IRED Pulse Period Smoke Test	t_{IRED}	1024	9.67	11.83	s
7	Chamber Sensitivity Test without Local Smoke		4096	38.9	47.1	
8	Push Button Test		32	0.302	0.370	
9	IRED Pulse Width	$t_{w(IRED)}$	T_f^{-1}	94	116	μs
10	IRED Rise Time IRED Fall Time	t_r t_f	— —	— —	30 200	μs
11	Silver and Brass Modulation Period Local or Remote Smoke	t_{MOD}	—	297	363	ms
11	Silver and Brass Duty Cycle Local or Remote Smoke	t_{ON}/t_{MOD}	—	73	77	%
13	Silver and Brass Chirp Pulse Period Low Supply or Degraded Chamber Sensitivity	t_{CH}	4096	38.9	47.1	s
14	Silver and Brass Chirp Pulse Width Low Supply or Degraded Chamber Sensitivity	$t_{w(CH)}$	1	9.5	11.5	ms
15	Rising Edge on I/O to Smoke Alarm Response Time Remote Smoke, No Local Smoke	t_{RR}	—	—	800	ms
16	Strobe Out Pulse Period Smoke Test	t_{STB}	1024	9.67	11.83	s
17	Chamber Sensitivity Test without Local Smoke		4096	38.9	47.1	
18	Low Supply Test without Local Smoke		4096	38.9	47.1	
19	Push Button Test		—	0.302	0.370	

1. Oscillator Period $T (= T_r + T_f)$ is determined by the external components R_1 , R_2 , and C_3 where $T_r = (0.6931) R_2 \times C_3$ and $T_f = (0.6031) R_1 \times C_3$.
The other timing characteristics are some multiple of the oscillator timing shown in the table.

Table 4. Pin Description

Pin	Symbol	Description
1	C1	A capacitor connected to this pin, shown in Figure 8 , determines the gain of the on-chip photo amplifier during push button test and chamber sensitivity test (high gain). The capacitor value is chosen such that the alarm is tripped from background reflections in the chamber during push button test. $A_v \approx 1 + (C1/10)$ where C1 is in pF. CAUTION: The value of the closed-loop gain should not exceed 10,000.
2	C2	A capacitor connected to this pin as shown in Figure 8 determines the gain of the on-chip photo amplifier except during push button or chamber sensitivity tests. $A_v \approx 1 + (C2/10)$ where C2 is in pF. This gain increases about 10% during the IRED pulse, after two consecutive local smoke detections. Resistor R14 must be installed in series with C2. $R14 \approx [1/(12\sqrt{C2})] - 680$ where R14 is in ohms and C2 is in farads.
3	DETECT	This input to the high-gain pulse amplifier is tied to the cathode of an external photodiodes. The photodiodes should have low capacitance and low dark leakage current. The diode must be shunted by a load resistor and is operated at zero bias. The Detect input must be ac/dc decoupled from all other signals, V_{DD} , and V_{SS} . Lead length and/or foil traces to this pin must be minimized, also. See Figure 9 .
4	STROBE	This output provides a strobed, regulated voltage referenced to V_{DD} . The temperature coefficient of this voltage is $\pm 0.2\%/^{\circ}\text{C}$ maximum from -10° to 60°C . The supply-voltage coefficient (line regulation) is $\pm 0.2\%/V$ maximum from 6 to 12 V. Strobe is tied to external resistor string R8, R9, and R10.
5	V_{DD}	This pin is connected to the positive supply potential and may range from +6 to +12 V with respect to V_{SS} . CAUTION: In battery-powered applications, reverse-polarity protection must be provided externally.
6	IRED	This output provides pulsed base current for external NPN transistor Q1 used as the infrared emitter driver. Q1 must have $\beta \geq 100$. At 10 mA, the temperature coefficient of the output voltage is typically $+0.5\%/^{\circ}\text{C}$ from -10° to 60°C . The supply-voltage coefficient (line regulation) is $\pm 0.2\%/V$ maximum from 6 to 12 V. The IRED pulse width (active-high) is determined by external components R1 and C3. With a 100 k Ω /1500 pF combination, the nominal width is 105 μs . To minimize noise impact, IRED is not active when the visible LED and horn outputs are active. IRED is active near the end of Strobe pulses for Smoke Tests, Chamber Sensitivity Test, and Push button Test.
7	I/O	This pin can be used to connect up to 40 units together in a wired-OR configuration for common signaling. V_{SS} is used as the return. An on-chip current sink minimizes noise pick up during non-smoke conditions and eliminates the need for an external pull-down resistor to complete the wired-OR. Remote units at lower supply voltages do not draw excessive current from a sending unit at a higher supply voltage. I/O can also be used to activate escape lights, auxiliary alarms, remote alarms, and/or auto-dialers. As an input, this pin feeds a positive-edge-triggered flip-flop whose output is sampled nominally every 625 ms during standby (using the recommended component values). A local-smoke condition or the push button-test mode forces this current-limited output to source current. All input signals are ignored when I/O is sourcing current. I/O is disabled by the on-chip power-on reset to eliminate nuisance signaling during battery changes or system power-up. If unused, I/O must be left unconnected.
8	BRASS	This half of the push-pull driver output is connected to the metal support electrode of a piezoelectric audio transducer and to the horn-starting resistor. A continuous modulated tone from the transducer is a smoke alarm indicating either local or remote smoke. A short beep or chirp is a trouble alarm indicating a low supply or degraded chamber sensitivity.
9	SILVER	This half of the push-pull driver output is connected to the ceramic electrode of a piezoelectric transducer and to the horn-starting capacitor.
10	FEEDBACK	This input is connected to both the feedback electrode of a self-resonating piezoelectric transducer and the horn-starting resistor and capacitor through current-limiting resistor R4. If unused, this pin must be tied to V_{SS} or V_{DD} .
11	LED	This active-low open-drain output directly drives an external visible LED at the pulse rates indicated below. The pulse width is equal to the OSC period. The load for the low-supply test is applied by this output. This low-supply test is non-coincident with the smoke tests, chamber sensitivity test, push button test, or any alarm signals. The LED also provides a visual indication of the detector status as follows, assuming the component values shown in Figure 8 : Standby (includes low-supply and chamber sensitivity tests) - Pulses every 43 seconds (nominal) Local Smoke - Pulses every 0.67 seconds (nominal) Remote Smoke - No pulses Push button Test - Pulses every 0.67 seconds (nominal)
12	OSC	This pin is used in conjunction with external resistor R2 (10 M Ω) to V_{DD} and external capacitor C3 (1500 pF) to V_{DD} to form an oscillator with a nominal period of 10.5 ms.
13	R1	This pin is used in conjunction with resistor R1 (100 k Ω) to pin 12 and C3 (1500 pF, see pin 12 description) to determine the IRED pulse width. With this RC combination, the nominal pulse width is 105 μs .
14	VSS	This pin is the negative supply potential and the return for the I/O pin. Pin 14 is usually tied to ground.
15	LOW-SUPPLY TRIP	This pin is connected to an external voltage which determines the low-supply alarm threshold. The trip voltage is obtained through a resistor divider connected between the V_{DD} and LED pins. The low-supply alarm threshold voltage (in volts) $\approx (5R7/R6) + 5$ where R6 and R7 are in the same units.

Table 4. Pin Description (Continued)

Pin	Symbol	Description
16	TEST	This input has an on-chip pull-down device and is used to manually invoke a test mode. The <i>Push Button Test</i> mode is initiated by a high level at pin 16 (usually depression of a S.P.S.T. normally-open push button switch to V_{DD}). After one oscillator cycle, IRED pulses approximately every 336 ms, regardless of the presence of smoke. Additionally, the amplifier gain is increased by automatic selection of C1. Therefore, the background reflections in the smoke chamber may be interpreted as smoke, generating a simulated-smoke condition. After the second IRED pulse, a successful test activates the horn-driver and I/O circuits. The active I/O allows remote signaling for system testing. When the Push Button Test switch is released, the Test input returns to V_{SS} due to the on-chip pull-down device. After one oscillator cycle, the amplifier gain returns to normal, thereby removing the simulated-smoke condition. After two additional IRED pulses, less than a second, the IC exits the alarm mode and returns to standby timing.

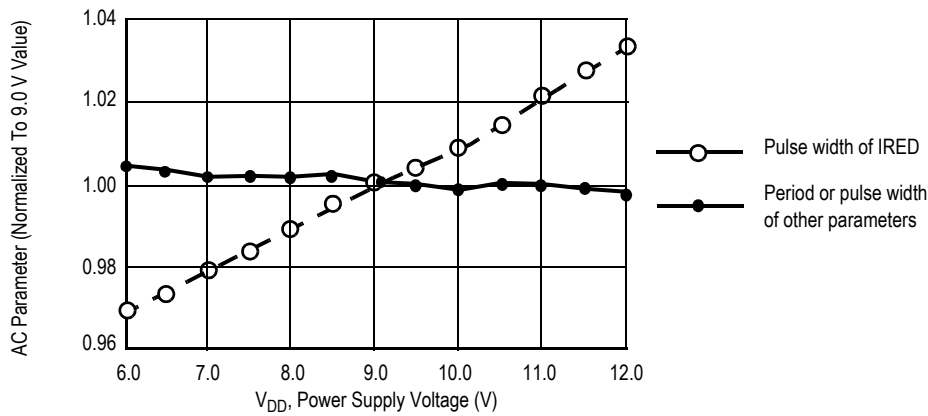

Figure 3. AC Characteristics vs. Supply

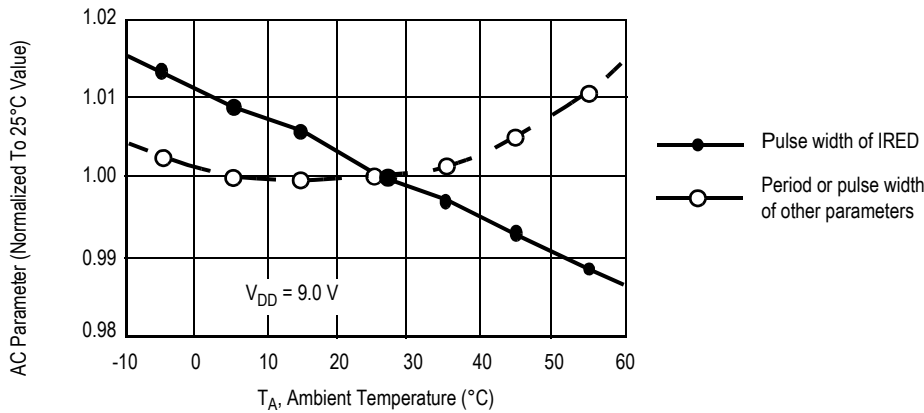
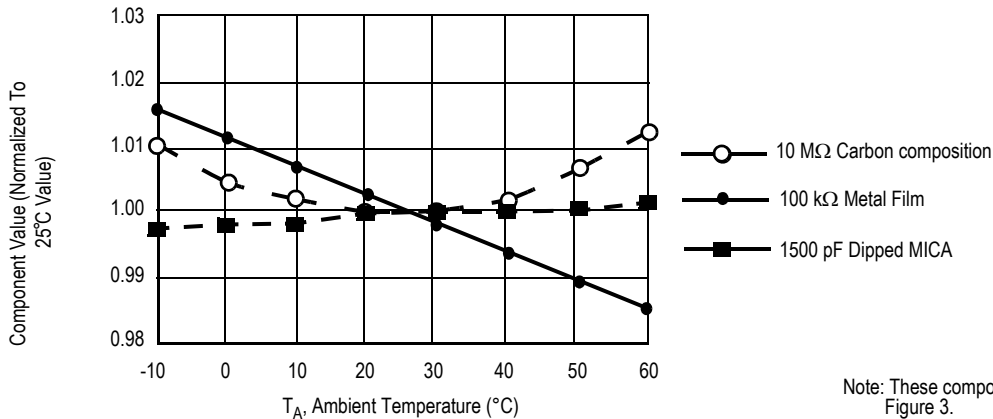
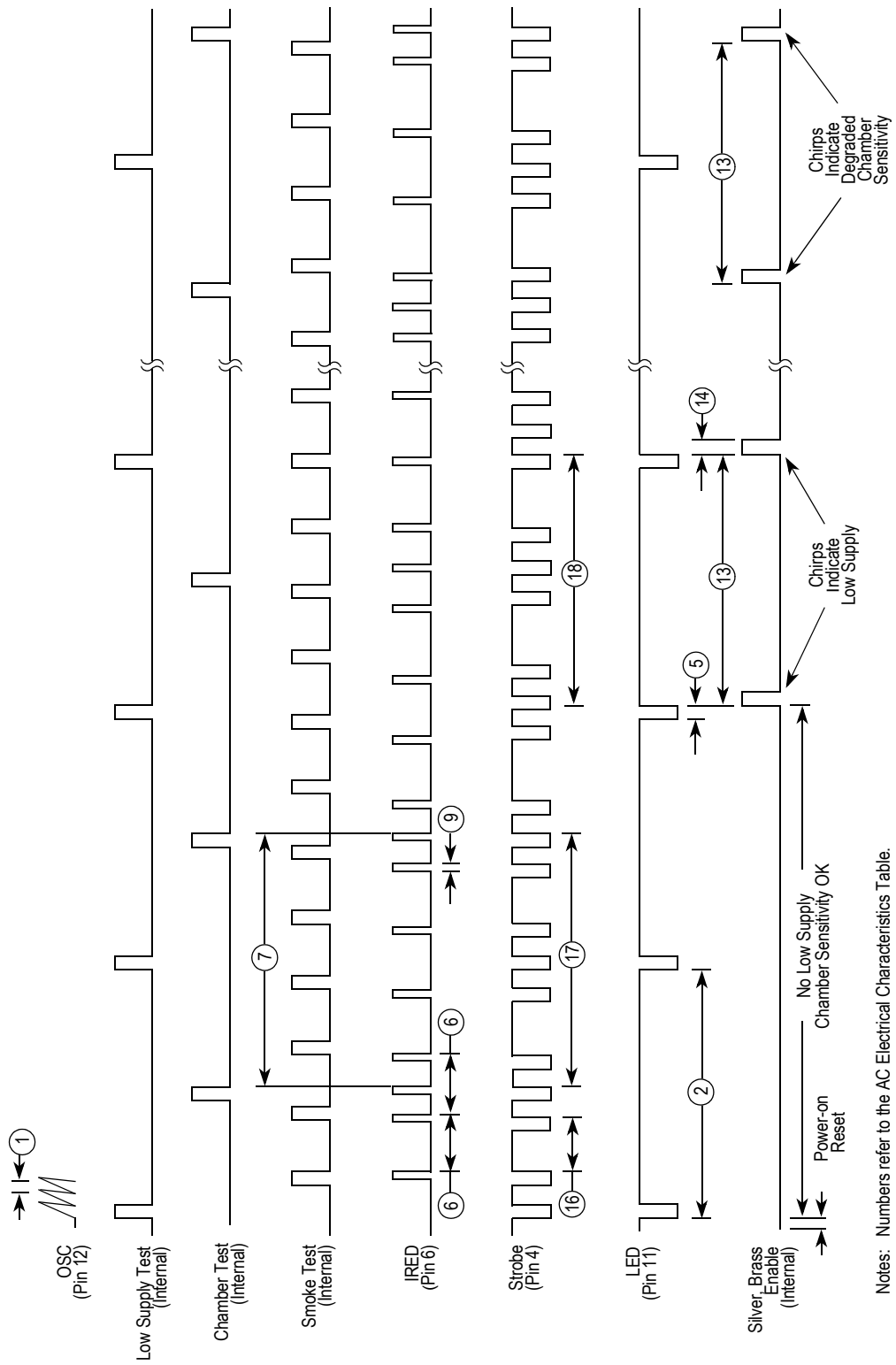

Figure 4. AC Characteristics vs. Temperature



Note: These components were used to generate Figure 3.

Figure 5. RC Component Variation Overtemperature



Notes: Numbers refer to the AC Electrical Characteristics Table. Illustration is not to scale.

Figure 6. Standby Timing Diagram

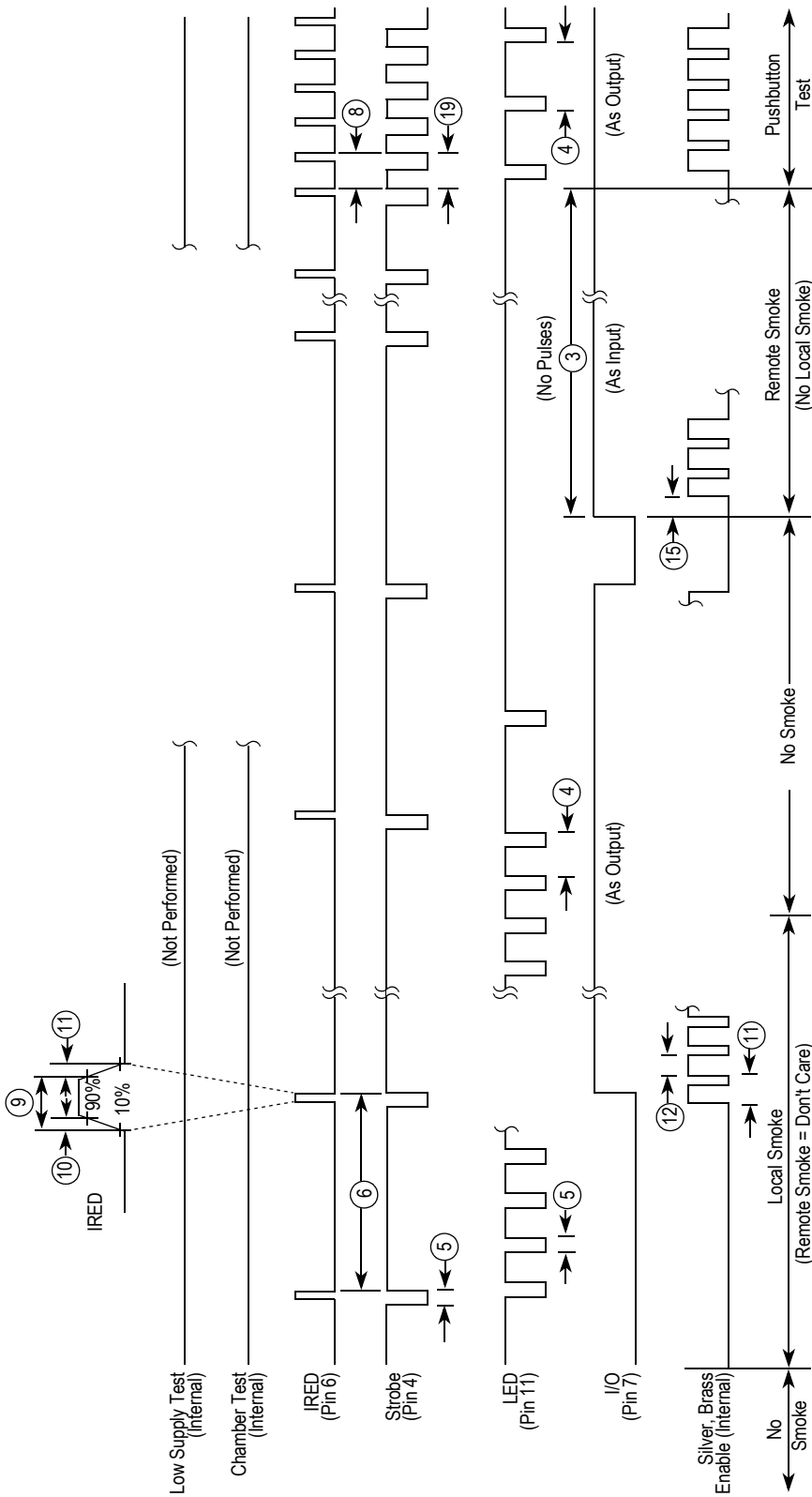

Notes: Numbers refer to the AC Electrical Characteristics Table. Illustration is not to scale.

Figure 7. Smoke Timing Diagram

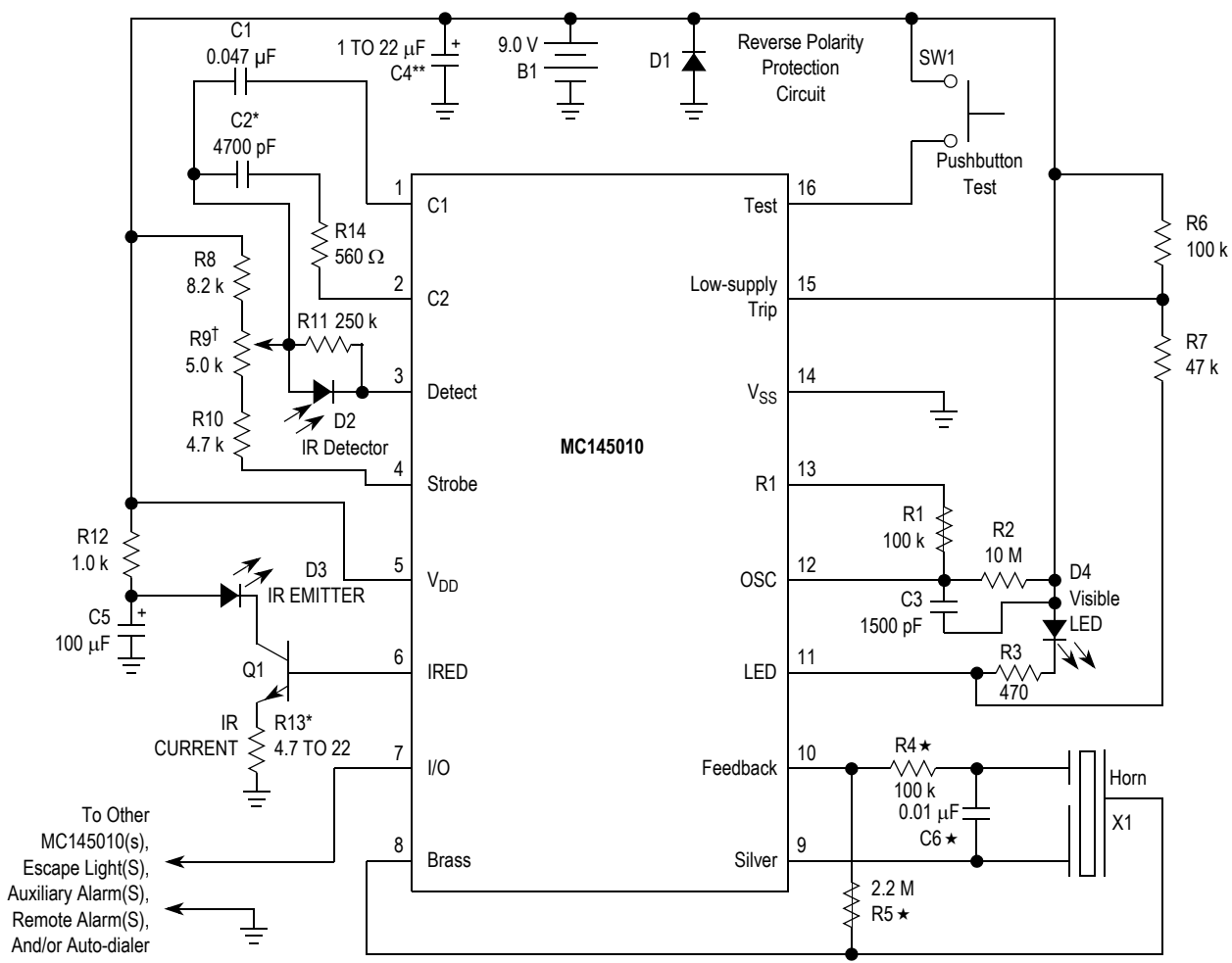

- ★ Values for R4, R5, and C6 may differ depending on type of piezoelectric horn used.
- * C2 and R13 are used for coarse sensitivity adjustment. Typical values are shown.
- † R9 is for fine sensitivity adjustment (optional). If fixed resistors are used, R8 = 12 k, R10 is 5.6 k to 10 k, and R9 is eliminated. When R9 is used, noise pickup is increased due to antenna effects. Shielding may be required.
- **C4 should be 22 μ F if B1 is a carbon battery. C4 could be reduced to 1 μ F when an alkaline battery is used.

Figure 8. Typical Battery-Powered Application

CALIBRATION

To facilitate checking the sensitivity and calibrating smoke detectors, the MC145010 can be placed in a calibration mode. In this mode, certain device pins are controlled/reconfigured as shown in Table 5. To place the part in the calibration mode, pin 16 (Test) must be pulled below the V_{SS}

pin with 100 μ A continuously drawn out of the pin for at least one cycle on the OSC pin. To exit this mode, the Test pin is floated for at least one OSC cycle.

In the calibration mode, the IRED pulse happens at every clock cycle and strobe is always on (active low). Also, Low Battery and supervisory tests are disabled in this mode.

Table 5. Configuration of Pins in the Calibration Mode

Description	Pin	Comment
I/O	7	Disabled as an output. Forcing this pin high places the photo amp output on pin 1 or 2, as determined by Low-Supply Trip. The amp's output appears as pulses and is referenced to V_{DD} .
Low-Supply Trip	15	If the I/O pin is high, pin 15 controls which gain capacitor is used. Low: normal gain, amp output on pin 1. High: supervisory gain, amp output on pin 2.
Feedback	10	Driving this input high enables hysteresis (10% gain increase) in the photo amp; pin 15 must be low.
OSC	12	Driving this input high brings the internal clock high. Driving the input low brings the internal clock low. If desired, the RC network for the oscillator may be left intact; this allows the oscillator to run similar to the normal mode of operation.
Silver	9	This pin becomes the smoke comparator output. When the OSC pin is toggling, positive pulses indicate that smoke has been detected. A static low level indicates no smoke.
Brass	8	This pin becomes the smoke integrator output. That is, two consecutive smoke detections are required for ON (static high level) and two consecutive no-detections for "off" (static low level).

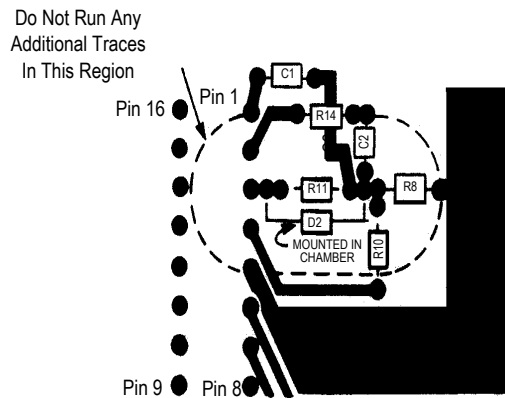

NOTES:

- Illustration is bottom view of layout using a Dip. Top view for SOIC layout is mirror image. Optional potentiometer R9 is not illustrated.
- Drawing is not to scale.
- Leads on D2, R11, R8, and R10 and their associated traces must be kept as short as possible. This practice minimizes noise pick-up.
- Pin 3 must be decoupled from all other traces.

Figure 9. Recommended PCB Layout

PACKAGE DIMENSIONS

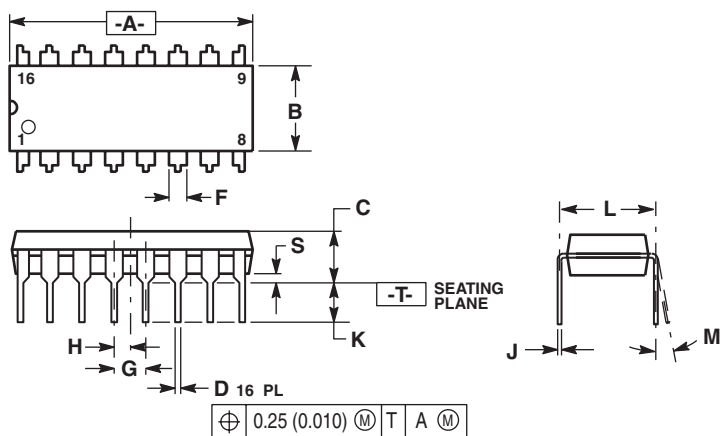

NOTES:

1. DIMENSIONING AND TOLERANCING PER ANSI Y14.5M, 1982.
2. CONTROLLING DIMENSION: INCH.
3. DIMENSION L TO CENTER OF LEADS WHEN FORMED PARALLEL.
4. DIMENSION B DOES NOT INCLUDE MOLD FLASH.
5. ROUNDED CORNERS OPTIONAL.

DIM	INCHES		MILLIMETERS	
	MIN	MAX	MIN	MAX
A	0.740	0.770	18.80	19.55
B	0.250	0.270	6.35	6.85
C	0.145	0.175	3.69	4.44
D	0.015	0.021	0.39	0.53
F	0.040	0.70	1.02	1.77
G	0.100 BSC		2.54 BSC	
H	0.050 BSC		1.27 BSC	
J	0.008	0.015	0.21	0.38
K	0.110	0.130	2.80	3.30
L	0.295	0.305	7.50	7.74
M	0	10	0	10
S	0.020	0.040	0.51	1.01

STYLE 1:

- PIN 1. CATHODE
- 2. CATHODE
- 3. CATHODE
- 4. CATHODE
- 5. CATHODE
- 6. CATHODE
- 7. CATHODE
- 8. CATHODE
- 9. ANODE
- 10. ANODE
- 11. ANODE
- 12. ANODE
- 13. ANODE
- 14. ANODE
- 15. ANODE
- 16. ANODE

STYLE 2:

- PIN 1. COMMON DRAIN
- 2. COMMON DRAIN
- 3. COMMON DRAIN
- 4. COMMON DRAIN
- 5. COMMON DRAIN
- 6. COMMON DRAIN
- 7. COMMON DRAIN
- 8. COMMON DRAIN
- 9. GATE
- 10. SOURCE
- 11. GATE
- 12. SOURCE
- 13. GATE
- 14. SOURCE
- 15. GATE
- 16. SOURCE

CASE 648-08 ISSUE R 16-LEAD PLASTIC DIP

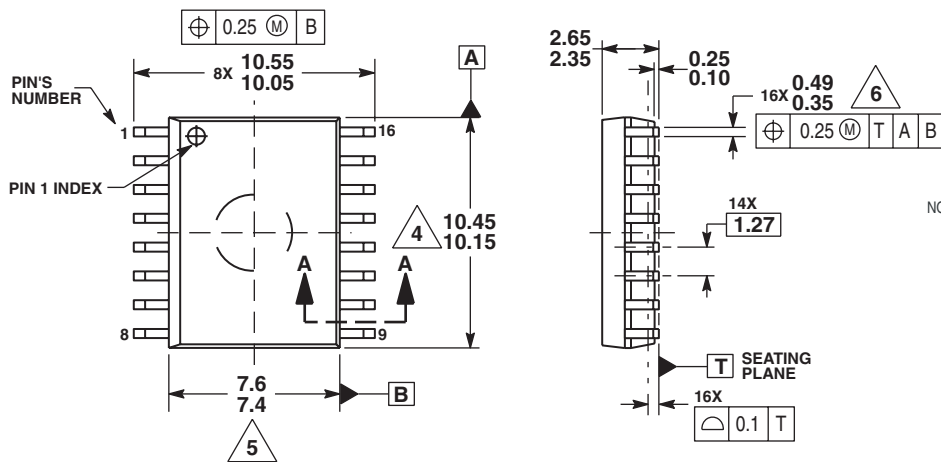

NOTES:

1. DIMENSIONS ARE IN MILLIMETERS.
2. DIMENSIONING AND TOLERANCING PER ASME Y14.5M, 1994.
3. DATUMS A AND B TO BE DETERMINED AT THE PLANE WHERE THE BOTTOM OF THE LEADS EXIT THE PLASTIC BODY.
4. THIS DIMENSION DOES NOT INCLUDE MOLD FLASH, PROTRUSION OR GATE BURRS. MOLD FLASH, PROTRUSION OR GATE BURRS SHALL NOT EXCEED 0.15mm PER SIDE. THIS DIMENSION IS DETERMINED AT THE PLANE WHERE THE BOTTOM OF THE LEADS EXIT THE PLASTIC BODY.
5. THIS DIMENSION DOES NOT INCLUDE INTER-LEAD FLASH OR PROTRUSIONS. INTER-LEAD FLASH AND PROTRUSIONS SHALL NOT EXCEED 0.25mm PER SIDE. THIS DIMENSION IS DETERMINED AT THE PLANE WHERE THE BOTTOM OF THE LEADS EXIT THE PLASTIC BODY.
6. THIS DIMENSION DOES NOT INCLUDE DAMBAR PROTRUSION. ALLOWABLE DAMBAR PROTRUSION SHALL NOT CAUSE THE LEAD WIDTH TO EXCEED 0.62mm.

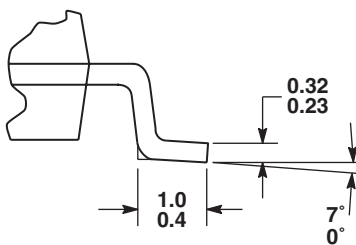
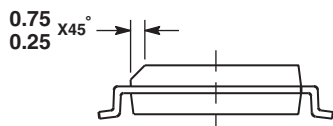

CASE 751G-04 ISSUE D 16-LEAD SOIC

How to Reach Us:

Home Page:

www.freescale.com

E-mail:

support@freescale.com

USA/Europe or Locations Not Listed:

Freescale Semiconductor
Technical Information Center, CH370
1300 N. Alma School Road
Chandler, Arizona 85224
+1-800-521-6274 or +1-480-768-2130
support@freescale.com

Europe, Middle East, and Africa:

Freescale Halbleiter Deutschland GmbH
Technical Information Center
Schatzbogen 7
81829 Muenchen, Germany
+44 1296 380 456 (English)
+46 8 52200080 (English)
+49 89 92103 559 (German)
+33 1 69 35 48 48 (French)
support@freescale.com

Japan:

Freescale Semiconductor Japan Ltd.
Headquarters
ARCO Tower 15F
1-8-1, Shimo-Meguro, Meguro-ku,
Tokyo 153-0064
Japan
0120 191014 or +81 3 5437 9125
support.japan@freescale.com

Asia/Pacific:

Freescale Semiconductor Hong Kong Ltd.
Technical Information Center
2 Dai King Street
Tai Po Industrial Estate
Tai Po, N.T., Hong Kong
+800 2666 8080
support.asia@freescale.com

For Literature Requests Only:

Freescale Semiconductor Literature Distribution Center
P.O. Box 5405
Denver, Colorado 80217
1-800-441-2447 or 303-675-2140
Fax: 303-675-2150
LDCForFreescaleSemiconductor@hibbertgroup.com

Information in this document is provided solely to enable system and software implementers to use Freescale Semiconductor products. There are no express or implied copyright licenses granted hereunder to design or fabricate any integrated circuits or integrated circuits based on the information in this document.

Freescale Semiconductor reserves the right to make changes without further notice to any products herein. Freescale Semiconductor makes no warranty, representation or guarantee regarding the suitability of its products for any particular purpose, nor does Freescale Semiconductor assume any liability arising out of the application or use of any product or circuit, and specifically disclaims any and all liability, including without limitation consequential or incidental damages. "Typical" parameters that may be provided in Freescale Semiconductor data sheets and/or specifications can and do vary in different applications and actual performance may vary over time. All operating parameters, including "Typicals", must be validated for each customer application by customer's technical experts. Freescale Semiconductor does not convey any license under its patent rights nor the rights of others. Freescale Semiconductor products are not designed, intended, or authorized for use as components in systems intended for surgical implant into the body, or other applications intended to support or sustain life, or for any other application in which the failure of the Freescale Semiconductor product could create a situation where personal injury or death may occur. Should Buyer purchase or use Freescale Semiconductor products for any such unintended or unauthorized application, Buyer shall indemnify and hold Freescale Semiconductor and its officers, employees, subsidiaries, affiliates, and distributors harmless against all claims, costs, damages, and expenses, and reasonable attorney fees arising out of, directly or indirectly, any claim of personal injury or death associated with such unintended or unauthorized use, even if such claim alleges that Freescale Semiconductor was negligent regarding the design or manufacture of the part.

Freescale™ and the Freescale logo are trademarks of Freescale Semiconductor, Inc. All other product or service names are the property of their respective owners.

© Freescale Semiconductor, Inc. 2006. All rights reserved.

Looking for pricing, stock, or lifecycle information?

Click below to explore more details on WIN SOURCE:

 [View MC145010DW](#) on WIN SOURCE

 [NXP / Nexperia](#) Information

Optimize Your Supply Chain with WIN SOURCE Solutions

-  Global Sourcing Solution
-  Obsolete Management
-  Cost Control Management
-  Shortage Management
-  Alternative Solution
-  Excess Inventory Management