



**THE DATASHEET OF  
AD1585ARTZ-R2**



## FEATURES

- Series reference (2.5 V, 3 V, 4.096 V, 5 V)
- Low quiescent current: 70  $\mu\text{A}$  maximum
- Current output capability:  $\pm 5$  mA
- Wide supply range:  $V_{\text{IN}} = V_{\text{OUT}} + 200$  mV to 12 V
- Wideband noise (10 Hz to 10 kHz): 50  $\mu\text{V}$  rms
- Specified temperature range:  $-40^\circ\text{C}$  to  $+125^\circ\text{C}$
- Compact, surface-mount SOT-23 package
- Qualified for automotive applications

## APPLICATIONS

- Portable, battery-powered equipment; for example, notebook computers, cellular phones, pagers, PDAs, GPSs, and DMMs
- Computer workstations; suitable for use with a wide range of video RAMDACs
- Smart industrial transmitters
- PCMCIA cards
- Automotive
- Hard disk drives
- 3 V/5 V, 8-bit/12-bit data converters

## GENERAL DESCRIPTION

The [AD1582/AD1583/AD1584/AD1585](#) are low cost, low power, low dropout, precision band gap references. These designs are available as 3-terminal (series) devices and are packaged in the compact SOT-23, 3-lead surface-mount package. The versatility of these references makes them ideal for use in battery-powered 3 V or 5 V systems where there can be wide variations in supply voltage and a need to minimize power dissipation.

The superior accuracy and temperature stability of the [AD1582/AD1583/AD1584/AD1585](#) result from the precise matching and thermal tracking of on-chip components. Patented temperature drift curvature correction design techniques minimize the nonlinearities in the voltage output temperature characteristic.

## PIN CONFIGURATION

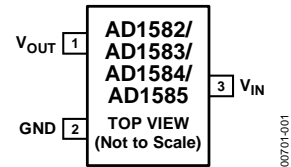

Figure 1. 3-Lead SOT-23-3 (RT Suffix)

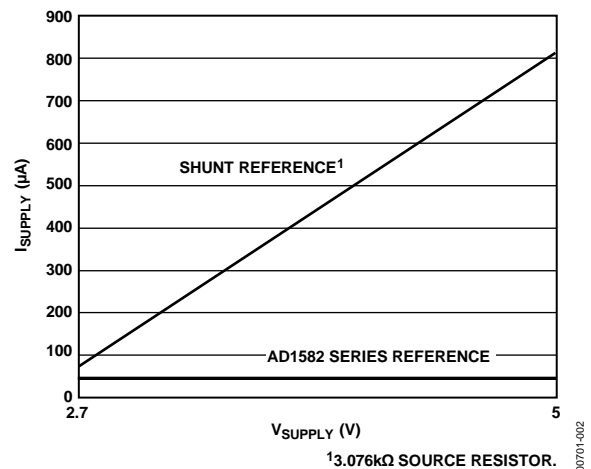

Figure 2. Supply Current ( $\mu\text{A}$ ) vs. Supply Voltage (V)

The [AD1582/AD1583/AD1584/AD1585](#) series mode devices source or sink up to 5 mA of load current and operate efficiently with only 200 mV of required headroom supply. These parts draw a maximum 70  $\mu\text{A}$  of quiescent current with only a 1.0  $\mu\text{A}/\text{V}$  variation with supply voltage. The advantage of these designs over conventional shunt devices is extraordinary. Valuable supply current is no longer wasted through an input series resistor, and maximum power efficiency is achieved at all input voltage levels.

The [AD1582/AD1583/AD1584/AD1585](#) are available in two grades, A and B, and are provided in a tiny footprint, the SOT-23. All grades are specified over the industrial temperature range of  $-40^\circ\text{C}$  to  $+125^\circ\text{C}$ .

Table 1. AD158x Products, Two Electrical Grades

Electrical Grade	Initial Accuracy			Temperature Coefficient (ppm $^\circ\text{C}$ )
	AD1582	AD1583/AD1585	AD1584	
B	0.08%	0.10%	0.10%	50
A	0.80%	1.00%	0.98%	100

Rev. M

[Document Feedback](#)

Information furnished by Analog Devices is believed to be accurate and reliable. However, no responsibility is assumed by Analog Devices for its use, nor for any infringements of patents or other rights of third parties that may result from its use. Specifications subject to change without notice. No license is granted by implication or otherwise under any patent or patent rights of Analog Devices. Trademarks and registered trademarks are the property of their respective owners.

## TABLE OF CONTENTS

Features .....	1
Applications .....	1
Pin Configuration .....	1
General Description .....	1
Revision History .....	2
Specifications .....	4
AD1582 Specifications .....	4
AD1583 Specifications .....	5
AD1584 Specifications .....	6
AD1585 Specifications .....	7
Absolute Maximum Ratings .....	8
ESD Caution .....	8
Terminology .....	9
Typical Performance Characteristics .....	10
Theory of Operation .....	11

## REVISION HISTORY

### 5/2019—Rev. L to Rev. M

Change to Endnote 1, Table 6 .....	8
------------------------------------	---

### 5/2018—Rev. K to Rev. L

Changes to Table 3 .....	5
Changes to Ordering Guide .....	17

### 10/2017—Rev. J to Rev. K

Change to Features and Table 1 Title .....	1
Changes to Table 2 .....	3
Changes to Temperature Range Specified Performance Parameter and Temperature Range Operating Performance Parameter; Table 3 .....	4
Changes to Temperature Range Specified Performance Parameter and Temperature Range Operating Performance Parameter; Table 4 .....	5
Changes to Temperature Range Specified Performance Parameter and Temperature Range Operating Performance Parameter; Table 5 .....	6
Added Solder Heat Effect Section .....	12
Added Figure 14; Renumbered Sequentially .....	12
Changes to Ordering Guide .....	16
Added Automotive Applications Section .....	16
Changes to Package Branding Information Section .....	16

### 2/2013—Rev. I to Rev. J

Change to Table 6 .....	7
Changes to Ordering Guide .....	16

Applications Information .....	12
Temperature Performance .....	12
Voltage Output Nonlinearity vs. Temperature .....	12
Output Voltage Hysteresis .....	13
Solder Heat Effect .....	13
Supply Current vs. Temperature .....	13
Supply Voltage .....	13
AC Performance .....	13
Noise Performance and Reduction .....	14
Turn-On Time .....	14
Dynamic Performance .....	15
Outline Dimensions .....	16
Ordering Guide .....	17
Automotive Applications .....	17

### 5/2010—Rev. H to Rev. I

Changes to Figure 10 .....	11
Updated Outline Dimensions .....	16
Changes to Ordering Guide .....	16

### 11/2007—Rev. G to Rev. H

Deleted C Grade .....	Universal
Changes to VOERR Parameter .....	3
Changes to Ordering Guide .....	16

### 6/2006—Rev. F to Rev. G

Changes to Features .....	1
Changes to General Description .....	1

### 2/2006—Rev. E to Rev. F

Updated Format .....	Universal
Changes to Features .....	1
Changes to Table 6 .....	7
Changes to Ordering Guide .....	16

### 6/2005—Rev. D to Rev. E

Changes to Ordering Guide .....	7
Moved Package Branding Section .....	7

### 6/2004—Rev. C to Rev. D

Changes to Ordering Guide .....	6
Updated Outline Dimensions .....	13

**12/2002—Rev. B to Rev. C**

Changes to Features ..... 1  
Changes to General Description ..... 1  
Changes to Specifications..... 2  
Changes to Absolute Maximum Ratings..... 6  
Replaced TPC 3 ..... 8  
Changes to Temperature Performance Section ..... 9  
Replaced Figure 4 ..... 9  
Changes to Output Voltage Hysteresis Section ..... 10  
Updated SOT-23 Package..... 13

**3/1997—Revision 0: Initial Version**

## SPECIFICATIONS

## AD1582 SPECIFICATIONS

$T_A = T_{MIN}$  to  $T_{MAX}$ ,  $V_{IN} = 5$  V, unless otherwise noted.

Table 2.

Parameter	AD1582A			AD1582B			Unit
	Min	Typ	Max	Min	Typ	Max	
OUTPUT VOLTAGE (at 25°C) $V_O$	2.480	2.500	2.520	2.498	2.500	2.502	V
INITIAL ACCURACY ERROR (at 25°C) $V_{OERR}$	-20		+20	-2		+2	mV
$V_{OERR}$ (W-Grade)	-0.80		+0.80	-0.08		+0.08	%
				-6		+6	mV
				-0.24		+0.24	%
OUTPUT VOLTAGE TEMPERATURE DRIFT			100			50	ppm/°C
TEMPERATURE COEFFICIENT (TCV <sub>O</sub> ) -40°C < $T_A$ < +125°C		40	100		18	50	ppm/°C
0°C < $T_A$ < 70°C		35			15		ppm/°C
MINIMUM SUPPLY HEADROOM ( $V_{IN} - V_{OUT}$ )	200			200			mV
LOAD REGULATION							
0 mA < $I_{OUT}$ < 5 mA (-40°C to +85°C)			0.2			0.2	mV/mA
0 mA < $I_{OUT}$ < 5 mA (-40°C to +125°C)			0.4			0.4	mV/mA
-5 mA < $I_{OUT}$ < 0 mA (-40°C to +85°C)			0.25			0.25	mV/mA
-5 mA < $I_{OUT}$ < 0 mA (-40°C to +125°C)			0.45			0.45	mV/mA
-0.1 mA < $I_{OUT}$ < +0.1 mA (-40°C to +85°C)			2.7			2.7	mV/mA
-0.1 mA < $I_{OUT}$ < +0.1 mA (-40°C to +125°C)			3.5			3.5	mV/mA
LINE REGULATION $V_{OUT} + 200$ mV < $V_{IN}$ < 12 V $I_{OUT} = 0$ mA			25			25	μV/V
RIPPLE REJECTION ( $\Delta V_{OUT}/\Delta V_{IN}$ ) $V_{IN} = 5$ V ± 100 mV (f = 120 Hz)	80			80			dB
QUIESCENT CURRENT			70			70	μA
SHORT-CIRCUIT CURRENT TO GROUND			15			15	mA
NOISE VOLTAGE (at 25°C) 0.1 Hz to 10 Hz 10 Hz to 10 kHz		70			70		μV p-p μV rms
		50			50		
TURN-ON SETTLING TIME TO 0.1% $C_L = 0.2$ μF			100			100	μs
LONG-TERM STABILITY 1000 Hours at 25°C		100			100		ppm/1000 hr
OUTPUT VOLTAGE HYSTERESIS		115			115		ppm
TEMPERATURE RANGE Specified Performance (A, B) Operating Performance (A, B)	-40		+125	-40		+125	°C
	-55		+125	-55		+125	°C

**AD1583 SPECIFICATIONS**

$T_A = T_{MIN}$  to  $T_{MAX}$ ,  $V_{IN} = 5$  V, unless otherwise noted.

**Table 3.**

Parameter	AD1583A			AD1583B			Unit
	Min	Typ	Max	Min	Typ	Max	
OUTPUT VOLTAGE (at 25°C) $V_O$	2.970	3.000	3.030	2.997	3.000	3.003	V
INITIAL ACCURACY ERROR (at 25°C) $V_{OERR}$	-30		+30	-3		+3	mV
$V_{OERR}$ (W Grade)	-1.0		+1.0	-0.1		+0.1	%
				-8		+8	mV
				-0.27		+0.27	%
OUTPUT VOLTAGE TEMPERATURE DRIFT			100			50	ppm/°C
TEMPERATURE COEFFICIENT (TCV <sub>O</sub> ) -40°C < $T_A$ < +125°C		40	100		18	50	ppm/°C
0°C < $T_A$ < 70°C		35			15		ppm/°C
MINIMUM SUPPLY HEADROOM ( $V_{IN} - V_{OUT}$ )	200			200			mV
LOAD REGULATION							
0 mA < $I_{OUT}$ < 5 mA (-40°C to +85°C)			0.25			0.25	mV/mA
0 mA < $I_{OUT}$ < 5 mA (-40°C to +125°C)			0.45			0.45	mV/mA
-5 mA < $I_{OUT}$ < 0 mA (-40°C to +85°C)			0.40			0.40	mV/mA
-5 mA < $I_{OUT}$ < 0 mA (-40°C to +125°C)			0.6			0.6	mV/mA
-0.1 mA < $I_{OUT}$ < +0.1 mA (-40°C to +85°C)			2.9			2.9	mV/mA
-0.1 mA < $I_{OUT}$ < +0.1 mA (-40°C to +125°C)			3.7			3.7	mV/mA
LINE REGULATION $V_{OUT} + 200$ mV < $V_{IN}$ < 12 V $I_{OUT} = 0$ mA			25			25	μV/V
RIPPLE REJECTION ( $\Delta V_{OUT}/\Delta V_{IN}$ ) $V_{IN} = 5$ V ± 100 mV (f = 120 Hz)	80			80			dB
QUIESCENT CURRENT			70			70	μA
SHORT-CIRCUIT CURRENT TO GROUND			15			15	mA
NOISE VOLTAGE (at 25°C) 0.1 Hz to 10 Hz 10 Hz to 10 kHz		85			85		μV p-p μV rms
		60			60		
TURN-ON SETTLING TIME TO 0.1% $C_L = 0.2$ μF			120			120	μs
LONG-TERM STABILITY 1000 Hours at 25°C		100			100		ppm/1000 hr
OUTPUT VOLTAGE HYSTERESIS		115			115		ppm
TEMPERATURE RANGE							
Specified Performance (A, B)	-40		+125	-40		+125	°C
Operating Performance (A, B)	-55		+125	-55		+125	°C

**AD1584 SPECIFICATIONS**

$T_A = T_{MIN}$  to  $T_{MAX}$ ,  $V_{IN} = 5\text{ V}$ , unless otherwise noted.

**Table 4.**

Parameter	AD1584A			AD1584B			Unit
	Min	Typ	Max	Min	Typ	Max	
OUTPUT VOLTAGE (at 25°C) $V_O$	4.056	4.096	4.136	4.092	4.096	4.100	V
INITIAL ACCURACY ERROR (at 25°C) $V_{OERR}$	-40 -0.98		+40 +0.98	-4 -0.1		+4 +0.1	mV %
OUTPUT VOLTAGE TEMPERATURE DRIFT			100			50	ppm/°C
TEMPERATURE COEFFICIENT (TCV <sub>O</sub> ) -40°C < $T_A$ < +125°C 0°C < $T_A$ < 70°C		40 35	100		18 15	50	ppm/°C ppm/°C
MINIMUM SUPPLY HEADROOM ( $V_{IN} - V_{OUT}$ )	200			200			mV
LOAD REGULATION 0 mA < $I_{OUT}$ < 5 mA (-40°C to +85°C) 0 mA < $I_{OUT}$ < 5 mA (-40°C to +125°C) -5 mA < $I_{OUT}$ < 0 mA (-40°C to +85°C) -5 mA < $I_{OUT}$ < 0 mA (-40°C to +125°C) -0.1 mA < $I_{OUT}$ < +0.1 mA (-40°C to +85°C) -0.1 mA < $I_{OUT}$ < +0.1 mA (-40°C to +125°C)			0.32 0.52 0.40 0.6 3.2 4.1			0.32 0.52 0.40 0.6 3.2 4.1	mV/mA mV/mA mV/mA mV/mA mV/mA mV/mA
LINE REGULATION $V_{OUT} + 200\text{ mV} < V_{IN} 12\text{ V}$ $I_{OUT} = 0\text{ mA}$			25			25	μV/V
RIPPLE REJECTION ( $\Delta V_{OUT}/\Delta V_{IN}$ ) $V_{IN} = 5\text{ V} \pm 100\text{ mV}$ (f = 120 Hz)	80			80			dB
QUIESCENT CURRENT			70			70	μA
SHORT-CIRCUIT CURRENT TO GROUND			15			15	mA
NOISE VOLTAGE (at 25°C) 0.1 Hz to 10 Hz 10 Hz to 10 kHz		110 90			110 90		μV p-p μV rms
TURN-ON SETTLING TIME TO 0.1% $C_L = 0.2\text{ }\mu\text{F}$			140			140	μs
LONG-TERM STABILITY 1000 Hours at 25°C		100			100		ppm/1000 hr
OUTPUT VOLTAGE HYSTERESIS		115			115		ppm
TEMPERATURE RANGE Specified Performance (A, B) Operating Performance (A, B)	-40 -55		+125 -125	-40 -55		+125 +125	°C °C

**AD1585 SPECIFICATIONS**

$T_A = T_{MIN}$  to  $T_{MAX}$ ,  $V_{IN} = 6$  V, unless otherwise noted.

Table 5.

Parameter	AD1585A			AD1585B			Unit
	Min	Typ	Max	Min	Typ	Max	
OUTPUT VOLTAGE (at 25°C) $V_O$	4.950	5.000	5.050	4.995	5.000	5.005	V
INITIAL ACCURACY ERROR (at 25°C) $V_{OERR}$	-50 -1.0		+50 +1.0	-5 -0.10		+5 +0.10	mV %
OUTPUT VOLTAGE TEMPERATURE DRIFT			100			50	ppm/°C
TEMPERATURE COEFFICIENT (TCV <sub>O</sub> ) -40°C < $T_A$ < 125°C 0°C < $T_A$ < 70°C		40 35	100		18 15	50	ppm/°C ppm/°C
MINIMUM SUPPLY HEADROOM ( $V_{IN} - V_{OUT}$ )	200			200			mV
LOAD REGULATION 0 mA < $I_{OUT}$ < 5 mA (-40°C to +85°C) 0 mA < $I_{OUT}$ < 5 mA (-40°C to +125°C) -5 mA < $I_{OUT}$ < 0 mA (-40°C to +85°C) -5 mA < $I_{OUT}$ < 0 mA (-40°C to +125°C) -0.1 mA < $I_{OUT}$ < +0.1 mA (-40°C to +85°C) -0.1 mA < $I_{OUT}$ < +0.1 mA (-40°C to +125°C)			0.40 0.6 0.40 0.6 4 4.8			0.40 0.6 0.40 0.6 4 4.8	mV/mA mV/mA mV/mA mV/mA mV/mA mV/mA
LINE REGULATION $V_{OUT} + 200$ mV < $V_{IN}$ < 12 V $I_{OUT} = 0$ mA			25			25	μV/V
RIPPLE REJECTION ( $\Delta V_{OUT}/\Delta V_{IN}$ ) $V_{IN} = 6$ V ± 100 mV (f = 120 Hz)	80			80			dB
QUIESCENT CURRENT			70			70	μA
SHORT-CIRCUIT CURRENT TO GROUND			15			15	mA
NOISE VOLTAGE (at 25°C) 0.1 Hz to 10 Hz 10 Hz to 10 kHz		140 100			140 100		μV p-p μV rms
TURN-ON SETTLING TIME TO 0.1% $C_L = 0.2$ μF			175			175	μs
LONG-TERM STABILITY 1000 Hours at 25°C		100			100		ppm/1000 hr
OUTPUT VOLTAGE HYSTERESIS		115			115		ppm
TEMPERATURE RANGE Specified Performance (A, B) Operating Performance (A, B)	-40 -55		+125 +125	-40 -55		+125 +125	°C °C

## ABSOLUTE MAXIMUM RATINGS

Table 6.

Parameter	Rating
V <sub>IN</sub> to Ground	12 V
Internal Power Dissipation <sup>1</sup> SOT-23-3 (RT-3)	400 mW
Storage Temperature Range	−65°C to 150°C
Specified Temperature Range AD1582RT/AD1583RT/ AD1584RT/AD1585RT	−40°C to +125°C
Lead Temperature, Soldering Vapor Phase (60 sec)	215°C
Infrared (15 sec)	220°C

<sup>1</sup> This specification is for a device in free air at 25°C; for a SOT-23 package,  $\theta_{JA} = 300^{\circ}\text{C}/\text{W}$ .

Stresses at or above those listed under Absolute Maximum Ratings may cause permanent damage to the product. This is a stress rating only; functional operation of the product at these or any other conditions above those indicated in the operational section of this specification is not implied. Operation beyond the maximum operating conditions for extended periods may affect product reliability.

### ESD CAUTION



**ESD (electrostatic discharge) sensitive device.** Charged devices and circuit boards can discharge without detection. Although this product features patented or proprietary protection circuitry, damage may occur on devices subjected to high energy ESD. Therefore, proper ESD precautions should be taken to avoid performance degradation or loss of functionality.

## TERMINOLOGY

### Temperature Coefficient (TCV<sub>O</sub>)

The change of output voltage over the operating temperature change and normalized by the output voltage at 25°C, expressed in ppm/°C. The equation follows

$$TCV_O [\text{ppm}/^\circ\text{C}] = \frac{V_O(T_2) - V_O(T_1)}{V_O(25^\circ\text{C}) \times (T_2 - T_1)} \times 10^6$$

where:

$V_O(25^\circ\text{C}) = V_O$  at 25°C.

$V_O(T_1) = V_O$  at Temperature 1.

$V_O(T_2) = V_O$  at Temperature 2.

### Line Regulation ( $\Delta V_O/\Delta V_{IN}$ ) Definition

The change in output voltage due to a specified change in input voltage. It includes the effects of self-heating. Line regulation is expressed in either percent per volt, parts per million per volt, or microvolts per volt change in input voltage.

### Load Regulation ( $\Delta V_O/\Delta I_{LOAD}$ )

The change in output voltage due to a specified change in load current. It includes the effects of self-heating. Load regulation is expressed in either microvolts per milliamper, parts per million per milliamper, or ohms of dc output resistance.

### Long-Term Stability ( $\Delta V_O$ )

Typical shift of output voltage at 25°C on a sample of parts subjected to an operation life test of 1000 hours at 125°C.

$$\Delta V_O = V_O(t_0) - V_O(t_1)$$

$$\Delta V_O [\text{ppm}] = \frac{V_O(t_0) - V_O(t_1)}{V_O(t_0)} \times 10^6$$

where:

$V_O(t_0) = V_O$  at 25°C at Time 0.

$V_O(t_1) = V_O$  at 25°C after 1000 hours of operation at 125°C.

### Thermal Hysteresis (V<sub>O\_HYS</sub>)

The change of output voltage after the device is cycled through temperatures from +25°C to -40°C to +85°C and back to +25°C. This is a typical value from a sample of parts put through such a cycle

$$V_{O\_HYS} = V_O(25^\circ\text{C}) - V_{O\_TC}$$

$$V_{O\_HYS} [\text{ppm}] = \frac{V_O(25^\circ\text{C}) - V_{O\_TC}}{V_O(25^\circ\text{C})} \times 10^6$$

where:

$V_O(25^\circ\text{C}) = V_O$  at 25°C.

$V_{O\_TC} = V_O$  at 25°C after temperature cycle at +25°C to -40°C to +85°C and back to +25°C.

### Operating Temperature

The temperature extremes at which the device can still function. Parts can deviate from their specified performance outside the specified temperature range.

TYPICAL PERFORMANCE CHARACTERISTICS

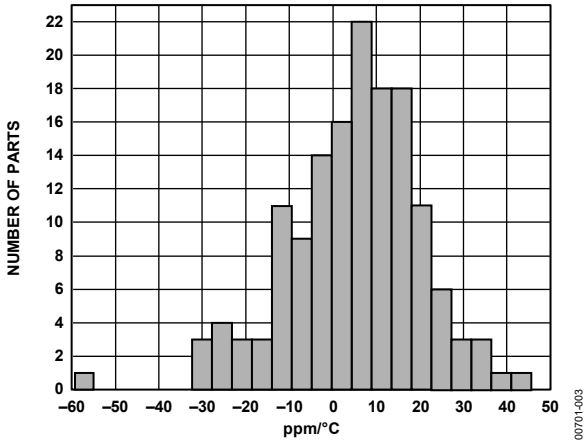

Figure 3. Typical Output Voltage Temperature Drift Distribution

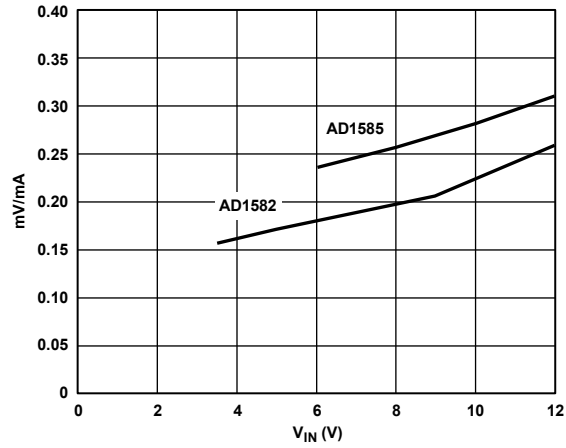

Figure 6. Load Regulation vs.  $V_{IN}$

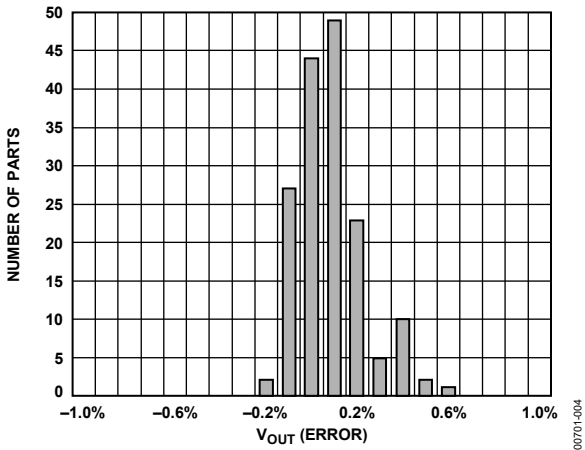

Figure 4. Typical Output Voltage Error Distribution

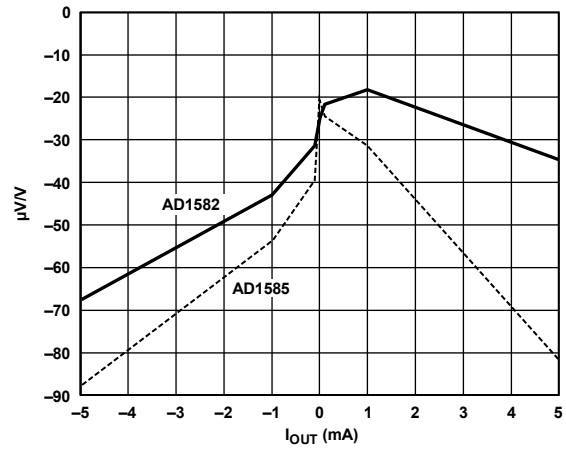

Figure 7. Line Regulation vs.  $I_{LOAD}$

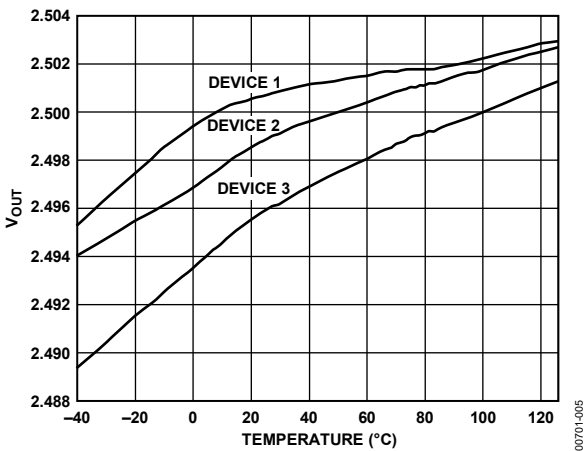

Figure 5. Typical Temperature Drift Characteristic Curves

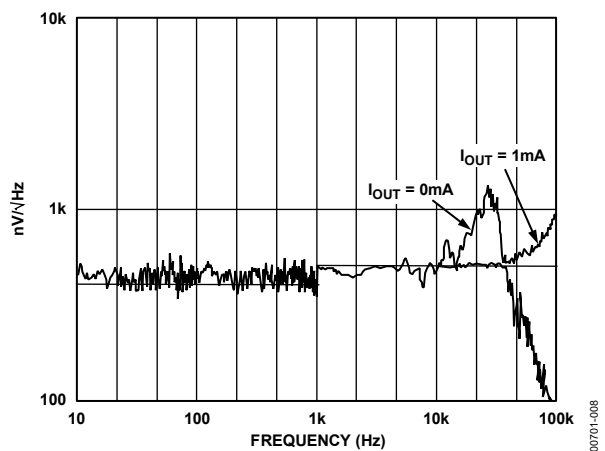

Figure 8. Noise Spectral Density

## THEORY OF OPERATION

The AD1582/AD1583/AD1584/AD1585 use the band gap concept to produce stable, low temperature coefficient voltage references suitable for high accuracy data acquisition components and systems. These parts of precision references use the underlying temperature characteristics of a silicon transistor's base emitter voltage in the forward-biased operating region. Under this condition, all such transistors have a  $-2 \text{ mV}/^\circ\text{C}$  temperature coefficient (TC) and a  $V_{BE}$  that, when extrapolated to absolute zero, 0 K (with collector current proportional to absolute temperature), approximates the silicon band gap voltage. By summing a voltage that has an equal and opposite temperature coefficient of  $2 \text{ mV}/^\circ\text{C}$  with the  $V_{BE}$  of a forward-biased transistor, an almost 0 TC reference can be developed. In the AD1582/AD1583/AD1584/AD1585 simplified circuit diagram shown in Figure 9, such a compensating voltage,  $V_1$ , is derived by driving two transistors at different current densities and amplifying the resultant  $V_{BE}$  difference ( $\Delta V_{BE}$ , which has a positive TC). The sum of  $V_{BE}$  and  $V_1$  ( $V_{BG}$ ) is then buffered and amplified to produce stable reference voltage outputs of 2.5 V, 3 V, 4.096 V, and 5 V.

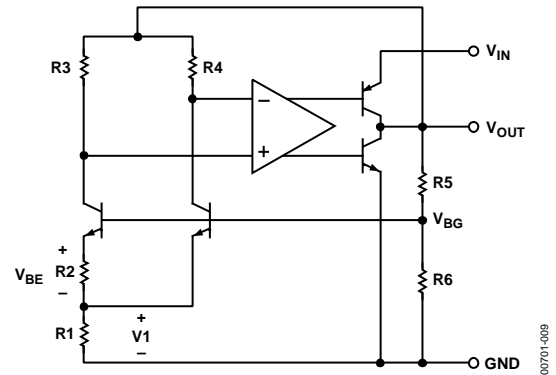

Figure 9. Simplified Schematic

## APPLICATIONS INFORMATION

The AD1582/AD1583/AD1584/AD1585 are series references that can be used for many applications. To achieve optimum performance with these references, only two external components are required. Figure 10 shows the AD1582/AD1583/AD1584/AD1585 configured for operation under all loading conditions. With a simple 4.7  $\mu\text{F}$  capacitor attached to the input and a 1  $\mu\text{F}$  capacitor applied to the output, the devices can achieve specified performance for all input voltage and output current requirements. For best transient response, add a 0.1  $\mu\text{F}$  capacitor in parallel with the 4.7  $\mu\text{F}$  capacitor. While a 1  $\mu\text{F}$  output capacitor can provide stable performance for all loading conditions, the AD1582/AD1583/AD1584/AD1585 can operate under low ( $-100 \mu\text{A} < I_{\text{OUT}} < +100 \mu\text{A}$ ) current conditions with just a 0.2  $\mu\text{F}$  output capacitor. The 4.7  $\mu\text{F}$  capacitor on the input can be reduced to 1  $\mu\text{F}$  in this condition.

Unlike conventional shunt reference designs, the AD1582/AD1583/AD1584/AD1585 provide stable output voltages at constant operating current levels. When properly decoupled, as shown in Figure 10, these devices can be applied to any circuit and provide superior low power solutions.

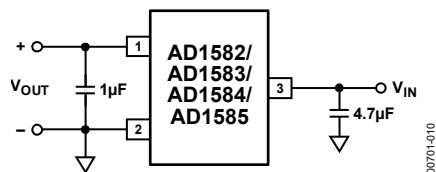

Figure 10. Typical Connection Diagram

### TEMPERATURE PERFORMANCE

The AD1582/AD1583/AD1584/AD1585 are designed for applications where temperature performance is important. Extensive temperature testing and characterization ensure that device performance is maintained over the specified temperature range.

The error band guaranteed with the AD1582/AD1583/AD1584/AD1585 is the maximum deviation from the initial value at 25°C. Therefore, for a given grade of the AD1582/AD1583/AD1584/AD1585, the designer can easily determine the maximum total error by summing initial accuracy and temperature variation. For example, for the AD1582BRT, the initial tolerance is  $\pm 2 \text{ mV}$ , and the temperature error band is  $\pm 8 \text{ mV}$ ; therefore, the reference is guaranteed to be  $2.5 \text{ V} \pm 10 \text{ mV}$  from  $-40^\circ\text{C}$  to  $+125^\circ\text{C}$ .

Figure 11 shows the typical output voltage drift for the AD1582/AD1583/AD1584/AD1585 and illustrates the methodology. The box in Figure 11 is bounded on the x-axis by operating temperature extremes. It is bounded on the y-axis by the maximum and minimum output voltages observed over the operating temperature range. The slope of the diagonal drawn from the initial output value at 25°C to the output values at  $+125^\circ\text{C}$  and  $-40^\circ\text{C}$  determines the performance grade of the device.

Duplication of these results requires a test system that is highly accurate with stable temperature control. Evaluation of the AD1582/AD1583/AD1584/AD1585 produces curves similar to those in Figure 5 and Figure 11, but output readings can vary depending on the test methods and test equipment used.

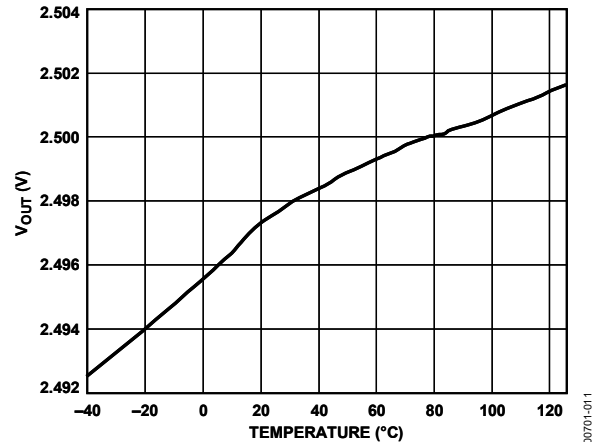

Figure 11. Output Voltage vs. Temperature

### VOLTAGE OUTPUT NONLINEARITY VS. TEMPERATURE

When using a voltage reference with data converters, it is important to understand the impact that temperature drift can have on converter performance. The nonlinearity of the reference output drift represents additional error that cannot be easily calibrated out of the overall system. To better understand the impact such a drift can have on a data converter, refer to Figure 12, where the measured drift characteristic is normalized to the endpoint average drift. The residual drift error for the AD1582/AD1583/AD1584/AD1585 of approximately 200 ppm demonstrates that these parts are compatible with systems that require 12-bit accurate temperature performance.

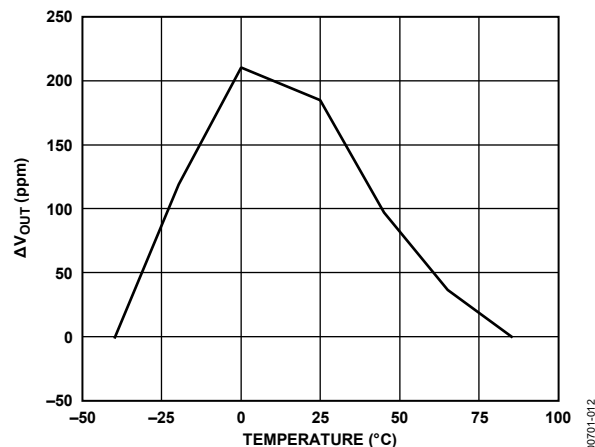

Figure 12. Residual Drift Error

**OUTPUT VOLTAGE HYSTERESIS**

High performance industrial equipment manufacturers can require the AD1582/AD1583/AD1584/AD1585 to maintain a consistent output voltage error at 25°C after the references are operated over the full temperature range. All references exhibit a characteristic known as output voltage hysteresis; however, the AD1582/AD1583/AD1584/AD1585 are designed to minimize this characteristic. This phenomenon can be quantified by measuring the change in the +25°C output voltage after temperature excursions from +125°C to +25°C and from -40°C to +25°C. Figure 13 displays the distribution of the AD1582/AD1583/AD1584/AD1585 output voltage hysteresis.

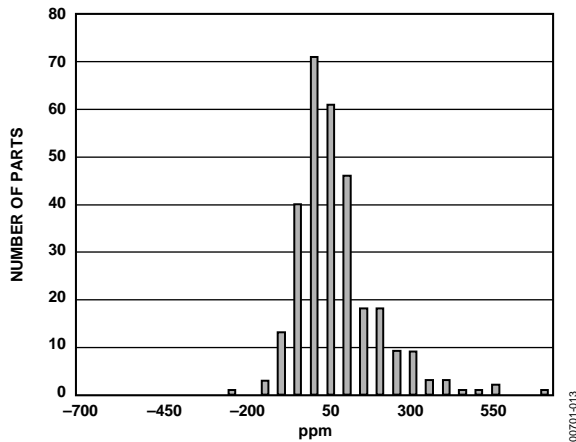

Figure 13. Output Voltage Hysteresis Distribution

**SOLDER HEAT EFFECT**

The mechanical stress and heat effect of soldering a device to a printed circuit board (PCB) can cause the output voltage of a reference to shift in value. The materials that make up a semiconductor device and its package have different rates of expansion and contraction. If the stress on the die has changed position, it can cause a shift on the output voltage after being exposed to extreme soldering temperatures. This shift is similar to, but more severe than, thermal hysteresis. Typical result of soldering temperature effects on the AD1582/AD1583/AD1584/AD1585 output values shift is shown in Figure 14. Figure 14 shows the output shift due to soldering and does not include mechanical stress.

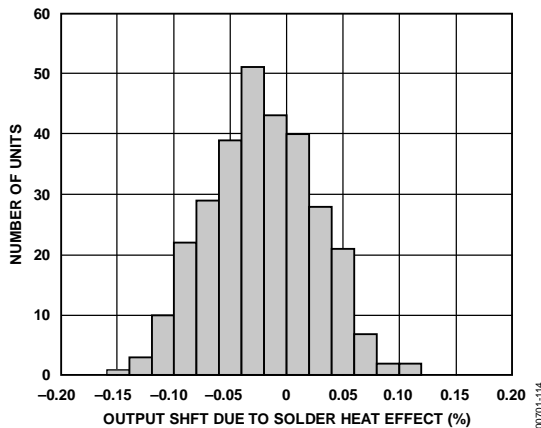

Figure 14. Output Shift due to Solder Heat Effect

**SUPPLY CURRENT VS. TEMPERATURE**

The quiescent current for the AD1582/AD1583/AD1584/AD1585 varies slightly over temperature and input supply range. Figure 15 illustrates the typical performance for the AD1582/AD1583/AD1584/AD1585 reference when varying both temperature and supply voltage. As is evident from Figure 15, the AD1582/AD1583/AD1584/AD1585 supply current increases only 1.0 μA/V, making this device extremely attractive for use in applications where there can be wide variations in supply voltage and a need to minimize power dissipation.

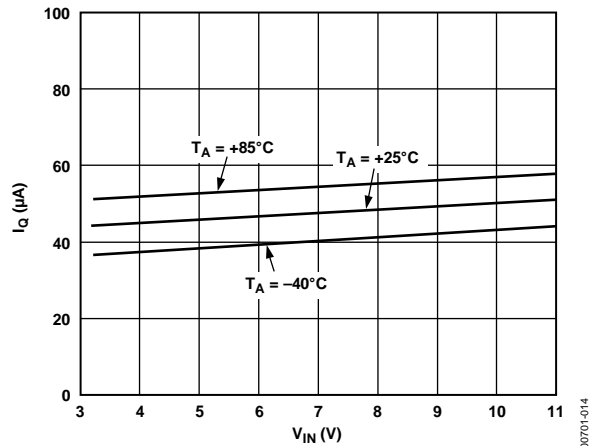

Figure 15. Typical Supply Current over Temperature

**SUPPLY VOLTAGE**

One of the ideal features of the AD1582/AD1583/AD1584/AD1585 is low supply voltage headroom. The parts can operate at supply voltages as low as 200 mV above VOUT and up to 12 V. However, if negative voltage is inadvertently applied to VIN with respect to ground, or any negative transient >5 V is coupled to VIN, the device can be damaged.

**AC PERFORMANCE**

To apply the AD1582/AD1583/AD1584/AD1585, it is important to understand the effects of dynamic output impedance and power supply rejection. In Figure 16, a voltage divider is formed by the AD1582/AD1583/AD1584/AD1585 output impedance and by the external source impedance. Figure 17 shows the effect of varying the load capacitor on the reference output. Power supply rejection ratio (PSRR) should be determined when characterizing the ac performance of a series voltage reference. Figure 18 shows a test circuit used to measure PSRR, and Figure 19 demonstrates the ability of the AD1582/AD1583/AD1584/AD1585 to attenuate line voltage ripple.

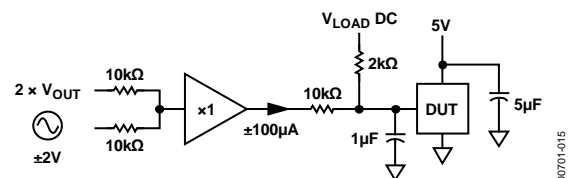

Figure 16. Output Impedance Test Circuit

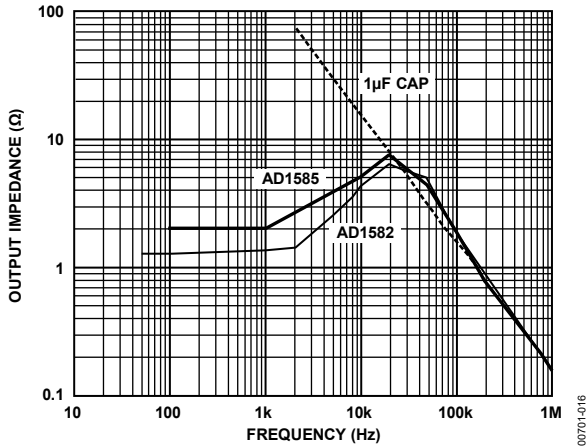

Figure 17. Output Impedance vs. Frequency

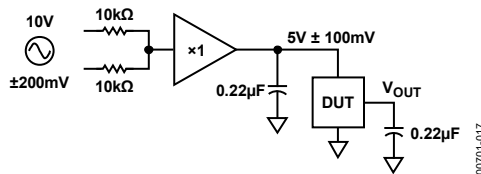

Figure 18. Ripple Rejection Test Circuit

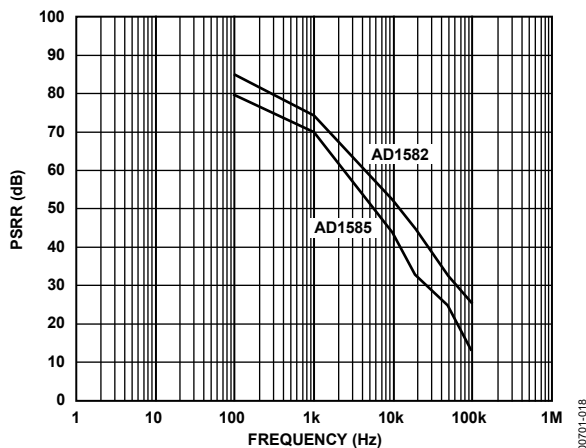

Figure 19. Ripple Rejection vs. Frequency

**NOISE PERFORMANCE AND REDUCTION**

The noise generated by the AD1582/AD1583/AD1584/AD1585 is typically less than 70  $\mu\text{V}$  p-p over the 0.1 Hz to 10 Hz frequency band. Figure 20 shows the 0.1 Hz to 10 Hz noise of a typical AD1582/AD1583/AD1584/AD1585. The noise measurement is made with a high gain band-pass filter. Noise in a 10 Hz to 10 kHz region is approximately 50  $\mu\text{V}$  rms. Figure 21 shows the broadband noise of a typical AD1582/AD1583/AD1584/AD1585. If further noise reduction is desired, add a 1-pole, low-pass filter between the output pin and ground. A time constant of 0.2 ms has a  $-3$  dB point at roughly 800 Hz and reduces the high frequency noise to about 16  $\mu\text{V}$  rms. It should be noted, however, that while additional filtering on the output can improve the noise performance of the AD1582/AD1583/AD1584/AD1585, the added output impedance can degrade the ac performance of the references.

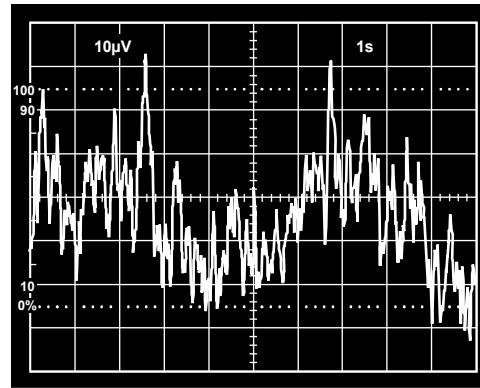

Figure 20. 10 Hz to 10 kHz Wideband Noise

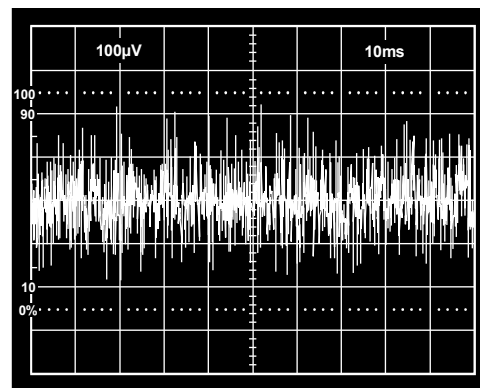

Figure 21. 1 Hz to 10 Hz Voltage Noise

**TURN-ON TIME**

Many low power instrument manufacturers are concerned with the turn-on characteristics of the components used in their systems. Fast turn-on components often enable the end user to save power by keeping power off when not needed. Turn-on settling time is defined as the time required, after the application of power (cold start), for the output voltage to reach its final value within a specified error. The two major factors affecting this are the active circuit settling time and the time required for the thermal gradients on the chip to stabilize. Figure 22 shows the turn-on settling and transient response test circuit. Figure 23 shows the turn-on characteristics of the AD1582/AD1583/AD1584/AD1585. These characteristics are generated from cold-start operation and represent the true turn-on waveform after power-up. Figure 24 shows the fine settling characteristics of the AD1582/AD1583/AD1584/AD1585. Typically, the reference settles to within 0.1% of its final value in about 100  $\mu\text{s}$ .

The device can momentarily draw excessive supply current when  $V_{\text{SUPPLY}}$  is slightly below the minimum specified level. Power supply resistance must be low enough to ensure reliable turn-on. Fast power supply edges minimize this effect.

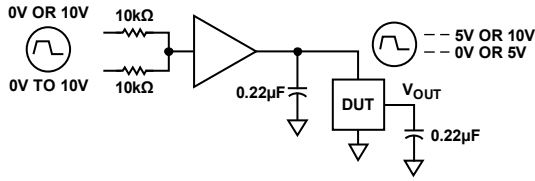

Figure 22. Turn-On/Transient Response Test Circuit

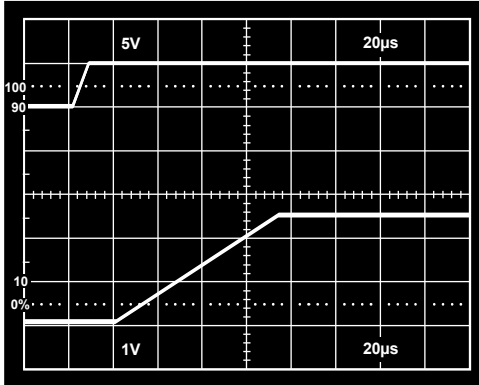

Figure 23. Turn-On Characteristics

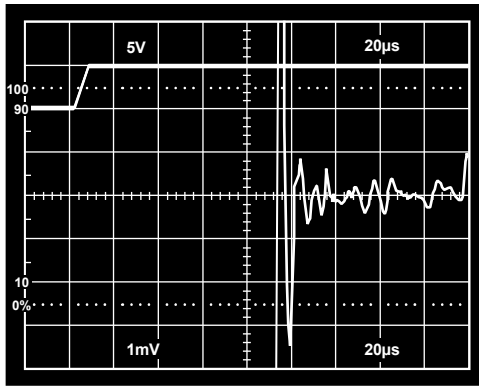

Figure 24. Turn-On Settling

### DYNAMIC PERFORMANCE

Many ADCs and DACs present transient current loads to the reference and poor reference response can degrade converter performance. The AD1582/AD1583/AD1584/AD1585 provide superior static and dynamic line and load regulation. Because these series references are capable of both sourcing and sinking large current loads, they exhibit excellent settling characteristics.

Figure 25 displays the line transient response for the AD1582/AD1583/AD1584/AD1585. The circuit used to perform such a measurement is shown in Figure 22, where the input supply voltage is shown in Figure 22, where the input supply voltage is toggled from 5 V to 10 V, and the input and output capacitors are each 0.22  $\mu$ F.

Figure 26 and Figure 27 show the load transient settling characteristics for the AD1582/AD1583/AD1584/AD1585 when load current steps of 0 mA to +5 mA and 0 mA to -1 mA are applied. The input supply voltage remains constant at 5 V; the input decoupling and output load capacitors are 4.7  $\mu$ F and 1  $\mu$ F, respectively; and the output current is toggled. For both positive and negative current loads, the reference responses settle very quickly and exhibit initial voltage spikes of less than 10 mV.

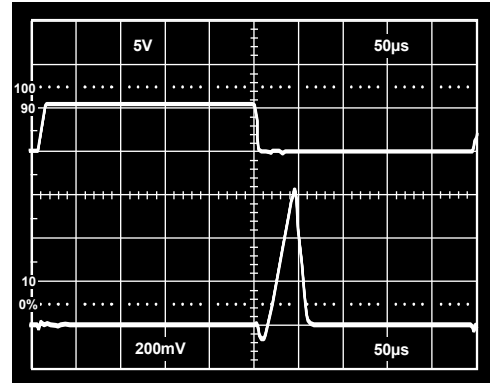

Figure 25. Line Transient Response

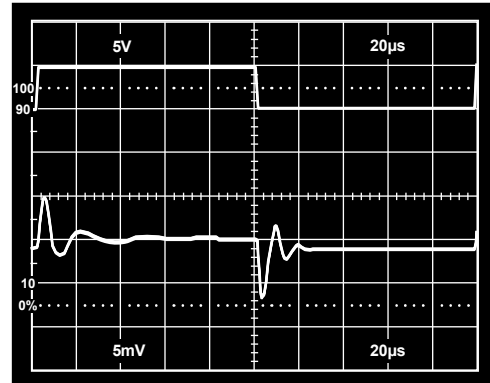

Figure 26. Load Transient Response (0 mA to 5 mA Load)

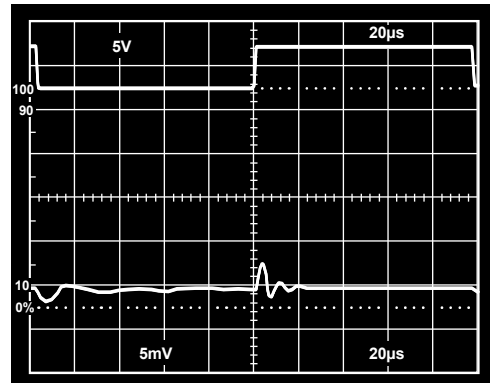
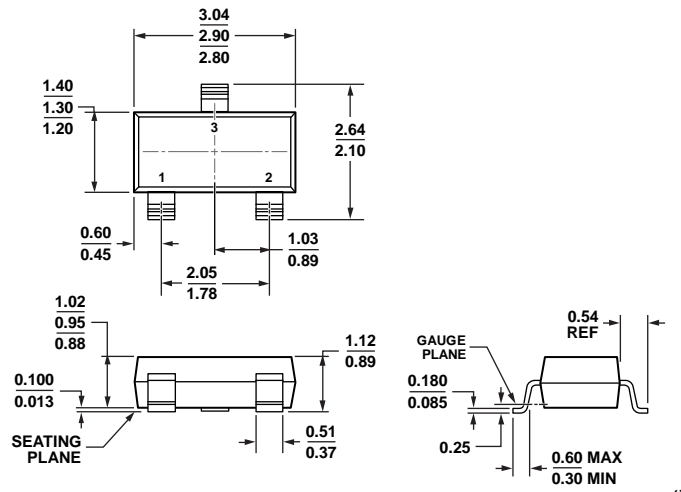

Figure 27. Load Transient Response (0 mA to -1 mA Load)

OUTLINE DIMENSIONS



COMPLIANT TO JEDEC STANDARDS TO-236-AB

Figure 28. 3-Lead Small Outline Transistor Package [SOT-23-3] (RT-3)

Dimensions shown in millimeters

011909-C

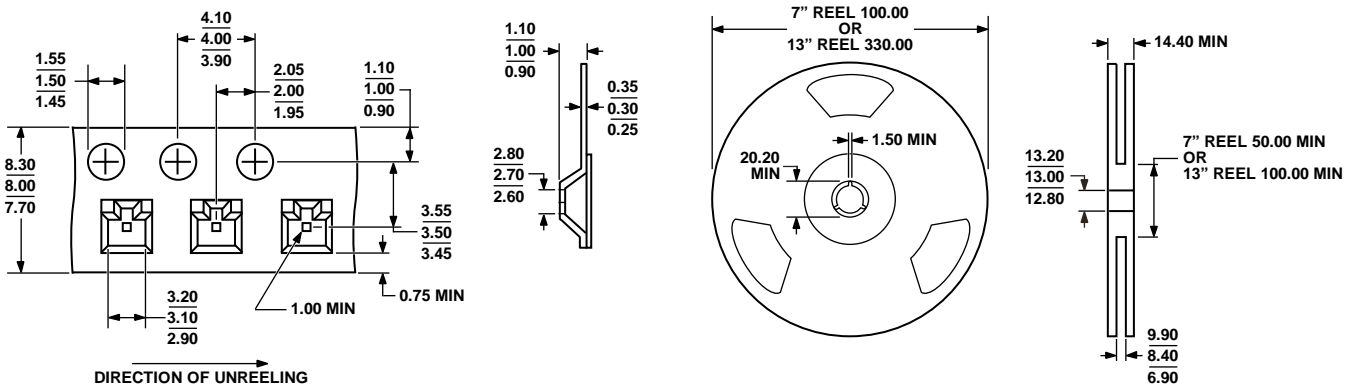

Figure 29. SOT-23 Tape and Reel Outline Dimension (RT-3)

Dimensions shown in millimeters

053006-0

## ORDERING GUIDE

Model <sup>1,2</sup>	Output Voltage (V)	Accuracy (mV)	Initial Accuracy (%)	Initial Temperature Coefficient (ppm/°C)	Package Description	Package Option	Marking Code	No. of Parts Banding per Reel
AD1582ARTZ-REEL7	2.50	20	0.80	100	SOT-23-3	RT-3	R1Z	3,000
AD1582BRTZ-REEL7	2.50	2	0.08	50	SOT-23-3	RT-3	R20	3,000
AD1582WBRTZ-R7	2.50	6	0.24	50	SOT-23-3	RT-3	R20	3,000
AD1583ARTZ-REEL7	3.00	30	1.00	100	SOT-23-3	RT-3	R22	3,000
AD1583BRTZ-REEL7	3.00	3	0.10	50	SOT-23-3	RT-3	R23	3,000
AD1583WBRTZ-R7	3.00	8	0.27	50	SOT-23-3	RT-3	R23	3,000
AD1584ARTZ-REEL7	4.096	40	0.98	100	SOT-23-3	RT-3	R25	3,000
AD1584BRTZ-REEL7	4.096	4	0.10	50	SOT-23-3	RT-3	R26	3,000
AD1585ARTZ-REEL7	5.00	50	1.00	100	SOT-23-3	RT-3	R28	3,000
AD1585BRTZ-REEL7	5.00	5	0.10	50	SOT-23-3	RT-3	R29	3,000

<sup>1</sup> Z = RoHS Compliant Part.

<sup>2</sup> W = Qualified for Automotive Applications.

## AUTOMOTIVE APPLICATIONS

The [AD1582W](#) and [AD1583W](#) models are available with controlled manufacturing to support the quality and reliability requirements of automotive applications. Note that these models may have specifications that differ from the commercial models; therefore, designers should review the Specifications section of this data sheet carefully. Only the automotive grade products shown are available for use in automotive applications. Contact your local Analog Devices account representative for specific product ordering information and to obtain the specific Automotive Reliability reports for these models.

## Looking for pricing, stock, or lifecycle information?

Click below to explore more details on WIN SOURCE:

 [View AD1585ARTZ-R2 on WIN SOURCE](#)

 [Analog Devices Inc. Information](#)

## Optimize Your Supply Chain with WIN SOURCE Solutions

-  Global Sourcing Solution
-  Obsolete Management
-  Cost Control Management
-  Shortage Management
-  Alternative Solution
-  Excess Inventory Management