



Single-ended Aluminum electrolytic capacitors

Series/Type: B41042

The following products presented in this data sheet are being withdrawn.

Ordering Code	Substitute Product	Date of Withdrawal	Deadline Last Orders	Last Shipments
B41042*		2013-02-22	2013-09-30	2014-03-31

For further information please contact your nearest EPCOS sales office, which will also support you in selecting a suitable substitute. The addresses of our worldwide sales network are presented at www.epcos.com/sales.

© EPCOS AG 2015. Reproduction, publication and dissemination of this publication, enclosures hereto and the information contained therein without EPCOS' prior express consent is prohibited.

EPCOS AG is a TDK Group Company.

Long-life grade capacitors**Applications**

- Professional switch mode power supplies

Features

- RoHS-compatible
- High C/V value
- Low impedance at high frequencies
- Load life of 5000 h at 105 °C

Construction

- Radial leads
- Aluminum case, fully insulated
- Charge-discharge proof
- Minus pole marking on the insulating sleeve
- Case with safety vent from diameter 8 mm

Delivery mode

- Bulk
- Taped, Ammo pack
- Cut
- Kinked

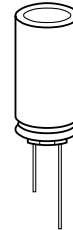

Single-ended capacitors
Low impedance – 105 °C

B41042

Specifications and characteristics in brief

Rated voltage V_R	6.3 ... 80 V DC									
Operating temp. range	–55 °C ... +105 °C									
Rated capacitance C_R (20 °C, 120 Hz)	0.47 ... 15000 μ F									
Capacitance tolerance	$\pm 20\% \triangleq M$									
Load life (105 °C, V_R , $I_{AC,R}$)	2000 h for $d = 5 \dots 6.3$ mm 3000 h for $d = 8$ mm 5000 h for $d \geq 10$ mm			Requirements: $\Delta C/C \leq \pm 25\%$ of initial value $\tan \delta \leq 2$ times initial specified limit $I_{leak} \leq$ initial specified limit						
Leakage current I_{leak} (20 °C, after 1 minute)	$I_{leak} \leq 0.03 \mu A \cdot \left(\frac{C_R}{\mu F} \cdot \frac{V_R}{V} \right)$ or 4 μA									
Dissipation factor (max.) (20 °C, 120 Hz)	For capacitance higher than 1000 μ F add 0.02 for every increase of 1000 μ F.									
	V_R (V DC)	6.3	10	16	25	35	50	63	80	
	$\tan \delta$	0.22	0.19	0.16	0.14	0.12	0.10	0.09	0.08	
Low temperature stability (impedance ratio) (120 Hz)	V_R (V DC)	6.3 ... 10			16 ... 35			50 ... 80		
	$Z(-55 \text{ °C})$	4			3			2		
	$Z(+20 \text{ °C})$									
Shelf life	After storage for 1000 h at 105 °C, the capacitors shall meet the requirement of load life test after reforming process. After test: V_R to be applied for 30 minutes, 24 to 48 hours before measurement.									
Frequency multiplier for rated ripple current		50 Hz	120 Hz	500 Hz	1 kHz	10 kHz	100 kHz			
	0.47 ... 27 μ F	0.40	0.55	0.65	0.80	0.90	1.00			
	33 ... 330 μ F	0.60	0.70	0.80	0.90	0.95	1.00			
	390 ... 1000 μ F	0.65	0.80	0.85	0.98	1.00	1.00			
	1200 μ F	0.80	0.90	0.95	0.98	1.00	1.00			
Temperature multiplier for rated ripple current	+70 °C			+85 °C			+105 °C			
	1.96			1.68			1.00			

Single-ended capacitors
Low impedance – 105 °C

B41042

Dimensional drawing

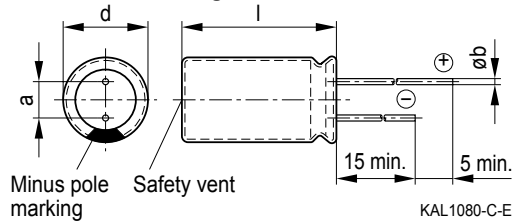

Minus pole marking
 Safety vent

KAL1080-C-E

Safety vent for diameter ≥ 8 mm.

Case dimensions

$d \times l$ mm	$d_{max} \times l_{max}$ mm	a mm	b mm
5 × 11	5.5 × 12.5	2.0 ± 0.5	0.5 ± 0.1
6.3 × 11	6.8 × 12.5	2.5 ± 0.5	0.5 ± 0.1
8 × 11.5	8.5 × 13.0	3.5 ± 0.5	0.6 ± 0.1
10 × 12.5	11.0 × 14.0	5.0 ± 0.5	0.6 ± 0.1
10 × 16	11.0 × 17.5	5.0 ± 0.5	0.6 ± 0.1
10 × 20	11.0 × 21.5	5.0 ± 0.5	0.6 ± 0.1
12.5 × 20	13.5 × 22.0	5.0 ± 0.5	0.6 ± 0.1
12.5 × 25	13.5 × 27.0	5.0 ± 0.5	0.6 ± 0.1
12.5 × 31.5	13.5 × 33.5	5.0 ± 0.5	0.6 ± 0.1
12.5 × 35.5	13.5 × 37.5	5.0 ± 0.5	0.6 ± 0.1
12.5 × 40	13.5 × 42.0	5.0 ± 0.5	0.6 ± 0.1
16 × 25	17.0 × 27.0	7.5 ± 0.5	0.8 ± 0.1
16 × 31.5	17.0 × 33.5	7.5 ± 0.5	0.8 ± 0.1
16 × 35.5	17.0 × 37.5	7.5 ± 0.5	0.8 ± 0.1
16 × 40	17.0 × 42.0	7.5 ± 0.5	0.8 ± 0.1
18 × 35.5	19.0 × 37.5	7.5 ± 0.5	0.8 ± 0.1
18 × 40	19.0 × 42.0	7.5 ± 0.5	0.8 ± 0.1

Please read *Cautions and warnings* and *Important notes* at the end of this document.

Overview of available types

V_R (V DC)	6.3	10	16	25
	Case dimensions $d \times l$ (mm)			
C_R (μ F)				
33				5 × 11
39				5 × 11
47			5 × 11	6.3 × 11
56			5 × 11	6.3 × 11
68		5 × 11	6.3 × 11	6.3 × 11
82		5 × 11	6.3 × 11	6.3 × 11
100	5 × 11	6.3 × 11	6.3 × 11	6.3 × 15
120	5 × 11	6.3 × 11	6.3 × 11	6.3 × 15
150	6.3 × 11	6.3 × 11	6.3 × 15	8 × 11.5
180	6.3 × 11	6.3 × 11	6.3 × 15	10 × 12.5
220	6.3 × 11	6.3 × 15	8 × 11.5	10 × 12.5
270	6.3 × 15	6.3 × 15	10 × 12.5	10 × 16
330	6.3 × 15	8 × 11.5	10 × 12.5	10 × 16
390	8 × 11.5	10 × 12.5	10 × 16	10 × 20
470	10 × 12.5	10 × 12.5	10 × 16	10 × 20
560	10 × 12.5	10 × 16	10 × 20	10 × 25
680	10 × 16	10 × 16	10 × 20	10 × 31.5
820	10 × 16	10 × 20	10 × 25	12.5 × 20
1000	10 × 20	10 × 20	10 × 31.5	12.5 × 25
1200	10 × 20	10 × 25	12.5 × 20	12.5 × 25
1500	10 × 25	10 × 31.5	12.5 × 25	12.5 × 31.5
1800	10 × 31.5	12.5 × 20	12.5 × 31.5	12.5 × 35.5
2200	10 × 31.5	12.5 × 25	12.5 × 31.5	12.5 × 40
2700	12.5 × 25	12.5 × 31.5	12.5 × 35.5	16 × 31.5
3300	12.5 × 25	12.5 × 35.5	12.5 × 40	16 × 35.5
3900	12.5 × 31.5	12.5 × 40	16 × 31.5	16 × 40
4700	12.5 × 35.5	16 × 31.5	16 × 35.5	18 × 40
5600	12.5 × 40	16 × 35.5	16 × 40	
6800	16 × 31.5	16 × 35.5	18 × 35.5	
8200	16 × 35.5	16 × 40	18 × 40	
10000	16 × 40	18 × 40		
12000	18 × 35.5			
15000	18 × 40			

Overview of available types

V_R (V DC)	35	50	63	80
	Case dimensions $d \times l$ (mm)			
C_R (μ F)				
0.47		5 × 11		
0.68		5 × 11		
1.0		5 × 11		
1.5		5 × 11		
2.2		5 × 11		
3.3		5 × 11		
4.7		5 × 11		5 × 11
6.8		5 × 11		5 × 11
10		5 × 11	5 × 11	6.3 × 11
12		5 × 11	5 × 11	6.3 × 11
15		5 × 11	6.3 × 11	6.3 × 11
18		5 × 11	6.3 × 11	6.3 × 11
22	5 × 11	6.3 × 11	6.3 × 11	6.3 × 15
27	5 × 11	6.3 × 11	6.3 × 11	6.3 × 15
33	6.3 × 11	6.3 × 11	6.3 × 15	8 × 11.5
39	6.3 × 11	6.3 × 11	6.3 × 15	10 × 12.5
47	6.3 × 11	6.3 × 15	8 × 11.5	10 × 12.5
56	6.3 × 11	6.3 × 15	10 × 12.5	10 × 16
68	6.3 × 15	8 × 11.5	10 × 12.5	10 × 20
82	6.3 × 15	10 × 12.5	10 × 16	10 × 20
100	8 × 11.5	10 × 16	10 × 20	10 × 25
120	10 × 12.5	10 × 16	10 × 20	10 × 31.5
150	10 × 12.5	10 × 20	10 × 25	10 × 31.5
180	10 × 16	10 × 20	10 × 31.5	12.5 × 25
220	10 × 16	10 × 25	12.5 × 20	12.5 × 31.5
270	10 × 20	10 × 31.5	12.5 × 25	12.5 × 31.5
330	10 × 20	10 × 31.5	12.5 × 25	12.5 × 35.5
390	10 × 25	12.5 × 25	12.5 × 31.5	12.5 × 40
470	10 × 31.5	12.5 × 25	12.5 × 35.5	16 × 31.5
560	12.5 × 20	12.5 × 31.5	12.5 × 40	16 × 35.5
680	12.5 × 25	12.5 × 35.5	16 × 31.5	16 × 40
820	12.5 × 25	12.5 × 40	16 × 35.5	18 × 35.5
1000	12.5 × 31.5	16 × 31.5	16 × 40	18 × 40
1200	12.5 × 35.5	16 × 35.5	18 × 40	

Please read *Cautions and warnings* and *Important notes* at the end of this document.

Overview of available types

V_R (V DC)	35	50	63	80
	Case dimensions $d \times l$ (mm)			
C_R (μ F)				
1500	12.5 × 40	16 × 40		
1800	16 × 31.5	18 × 35.5		
2200	16 × 35.5	18 × 40		
2700	16 × 40			
3300	18 × 40			

Single-ended capacitors
Low impedance – 105 °C

B41042

Technical data and ordering codes

V _R	C _R 120 Hz 20 °C μF	Case dimensions d × l mm	Z _{max} 100 kHz 20 °C Ω	I _{AC,R} 100 kHz 105 °C mA	Ordering codes (composition see below)
6.3	100	5 × 11	1.200	152	B41042A2107M***
	120	5 × 11	1.100	176	B41042A2127M***
	150	6.3 × 11	1.000	227	B41042A2157M***
	180	6.3 × 11	0.900	253	B41042A2187M***
	220	6.3 × 11	0.870	287	B41042A2227M***
	270	6.3 × 15	0.700	374	B41042A2277M***
	330	6.3 × 15	0.580	400	B41042A2337M***
	390	8 × 11.5	0.480	448	B41042A2397M***
	470	10 × 12.5	0.390	551	B41042A2477M***
	560	10 × 12.5	0.350	597	B41042A2567M***
	680	10 × 16	0.300	731	B41042A2687M***
	820	10 × 16	0.270	796	B41042A2827M***
	1000	10 × 20	0.230	953	B41042A2108M***
	1200	10 × 20	0.200	1022	B41042A2128M***
	1500	10 × 25	0.160	1221	B41042A2158M***
	1800	10 × 31.5	0.120	1375	B41042A2188M***
	2200	10 × 31.5	0.095	1472	B41042A2228M***
	2700	12.5 × 25	0.092	1592	B41042A2278M***
	3300	12.5 × 25	0.090	1711	B41042A2338M***
	3900	12.5 × 31.5	0.080	1914	B41042A2398M***
	4700	12.5 × 35.5	0.061	2102	B41042A2478M***
	5600	12.5 × 40	0.059	2373	B41042A2568M***
	6800	16 × 31.5	0.056	2376	B41042A2688M***
	8200	16 × 35.5	0.050	2551	B41042A2828M***
	10000	16 × 40	0.045	2753	B41042A2109M***
	12000	18 × 35.5	0.040	2825	B41042A2129M***
	15000	18 × 40	0.036	2963	B41042A2159M***

*** = Version
 000 = for standard leads, bulk
 001 = for kinked leads, bulk
 002 = for cut leads, bulk
 016 = for taped leads, Ammo pack, lead spacing a = 2.0 mm
 007 = for taped leads, Ammo pack, lead spacing a = 2.5 mm
 006 = for taped leads, Ammo pack, lead spacing a = 3.5 mm
 008 = for taped leads, Ammo pack, lead spacing a = 5.0 mm

Please read *Cautions and warnings* and
Important notes at the end of this document.

Single-ended capacitors
Low impedance – 105 °C

B41042

Technical data and ordering codes

V _R	C _R 120 Hz 20 °C μF	Case dimensions d × l mm	Z _{max} 100 kHz 20 °C Ω	I _{AC,R} 100 kHz 105 °C mA	Ordering code (composition see below)
10	68	5 × 11	1.600	152	B41042A3686M***
	82	5 × 11	1.400	176	B41042A3826M***
	100	6.3 × 11	1.200	211	B41042A3107M***
	120	6.3 × 11	1.000	236	B41042A3127M***
	150	6.3 × 11	0.820	268	B41042A3157M***
	180	6.3 × 11	0.680	291	B41042A3187M***
	220	6.3 × 15	0.580	372	B41042A3227M***
	270	6.3 × 15	0.520	405	B41042A3277M***
	330	8 × 11.5	0.470	463	B41042A3337M***
	390	10 × 12.5	0.430	552	B41042A3397M***
	470	10 × 12.5	0.390	596	B41042A3477M***
	560	10 × 16	0.330	733	B41042A3567M***
	680	10 × 16	0.280	798	B41042A3687M***
	820	10 × 20	0.230	987	B41042A3827M***
	1000	10 × 20	0.180	1061	B41042A3108M***
	1200	10 × 25	0.160	1282	B41042A3128M***
	1500	10 × 31.5	0.120	1443	B41042A3158M***
	1800	12.5 × 20	0.100	1472	B41042A3188M***
	2200	12.5 × 25	0.090	1715	B41042A3228M***
	2700	12.5 × 31.5	0.080	1941	B41042A3278M***
	3300	12.5 × 35.5	0.068	2184	B41042A3338M***
	3900	12.5 × 40	0.063	2362	B41042A3398M***
	4700	16 × 31.5	0.056	2422	B41042A3478M***
	5600	16 × 35.5	0.050	2613	B41042A3568M***
	6800	16 × 35.5	0.045	2682	B41042A3688M***
	8200	16 × 40	0.041	2812	B41042A3828M***
10000	18 × 40	0.360	3045	B41042A3109M***	

*** = Version
 000 = for standard leads, bulk
 001 = for kinked leads, bulk
 002 = for cut leads, bulk
 016 = for taped leads, Ammo pack, lead spacing a = 2.0 mm
 007 = for taped leads, Ammo pack, lead spacing a = 2.5 mm
 006 = for taped leads, Ammo pack, lead spacing a = 3.5 mm
 008 = for taped leads, Ammo pack, lead spacing a = 5.0 mm

Single-ended capacitors
Low impedance – 105 °C

B41042

Technical data and ordering codes

V _R	C _R 120 Hz 20 °C μF	Case dimensions d × l mm	Z _{max} 100 kHz 20 °C Ω	I _{AC,R} 100 kHz 105 °C mA	Ordering code (composition see below)
16	47	5 × 11	1.200	155	B41042A4476M***
	56	5 × 11	1.000	176	B41042A4566M***
	68	6.3 × 11	0.900	221	B41042A4686M***
	82	6.3 × 11	0.780	243	B41042A4826M***
	100	6.3 × 11	0.580	267	B41042A4107M***
	120	6.3 × 11	0.550	292	B41042A4127M***
	150	6.3 × 15	0.520	376	B41042A4157M***
	180	6.3 × 15	0.500	408	B41042A4187M***
	220	8 × 11.5	0.470	462	B41042A4227M***
	270	10 × 12.5	0.420	553	B41042A4277M***
	330	10 × 12.5	0.390	597	B41042A4337M***
	390	10 × 16	0.310	731	B41042A4397M***
	470	10 × 16	0.230	772	B41042A4477M***
	560	10 × 20	0.210	954	B41042A4567M***
	680	10 × 20	0.180	1021	B41042A4687M***
	820	10 × 25	0.150	1225	B41042A4827M***
	1000	10 × 31.5	0.120	1411	B41042A4108M***
	1200	12.5 × 20	0.100	1432	B41042A4128M***
	1500	12.5 × 25	0.082	1665	B41042A4158M***
	1800	12.5 × 31.5	0.075	1881	B41042A4188M***
	2200	12.5 × 31.5	0.068	2015	B41042A4228M***
	2700	12.5 × 35.5	0.062	2223	B41042A4278M***
	3300	12.5 × 40	0.056	1412	B41042A4338M***
	3900	16 × 31.5	0.050	2471	B41042A4398M***
	4700	16 × 35.5	0.045	2585	B41042A4478M***
	5600	16 × 40	0.041	2822	B41042A4568M***
	6800	18 × 35.5	0.036	2903	B41042A4688M***
	8200	18 × 40	0.035	3041	B41042A4828M***

*** = Version

- 000 = for standard leads, bulk
- 001 = for kinked leads, bulk
- 002 = for cut leads, bulk
- 016 = for taped leads, Ammo pack, lead spacing a = 2.0 mm
- 007 = for taped leads, Ammo pack, lead spacing a = 2.5 mm
- 006 = for taped leads, Ammo pack, lead spacing a = 3.5 mm
- 008 = for taped leads, Ammo pack, lead spacing a = 5.0 mm

Please read *Cautions and warnings* and
Important notes at the end of this document.

Single-ended capacitors
Low impedance – 105 °C

B41042

Technical data and ordering codes

V _R	C _R 120 Hz 20 °C μF	Case dimensions d × l mm	Z _{max} 100 kHz 20 °C Ω	I _{AC,R} 100 kHz 105 °C mA	Ordering code (composition see below)
25	33	5 × 11	1.500	156	B41042A5336M***
	39	5 × 11	1.300	173	B41042A5396M***
	47	6.3 × 11	1.200	212	B41042A5476M***
	56	6.3 × 11	1.000	237	B41042A5566M***
	68	6.3 × 11	0.830	261	B41042A5686M***
	82	6.3 × 11	0.750	228	B41042A5826M***
	100	6.3 × 15	0.580	372	B41042A5107M***
	120	6.3 × 15	0.500	409	B41042A5127M***
	150	8 × 11.5	0.430	461	B41042A5157M***
	180	10 × 12.5	0.400	553	B41042A5187M***
	220	10 × 12.5	0.390	628	B41042A5227M***
	270	10 × 16	0.300	753	B41042A5277M***
	330	10 × 16	0.230	798	B41042A5337M***
	390	10 × 20	0.200	986	B41042A5397M***
	470	10 × 20	0.180	1021	B41042A5477M***
	560	10 × 25	0.160	1223	B41042A5567M***
	680	10 × 31.5	0.130	1424	B41042A5687M***
	820	12.5 × 20	0.110	1433	B41042A5827M***
	1000	12.5 × 25	0.090	1661	B41042A5108M***
	1200	12.5 × 25	0.080	1765	B41042A5128M***
	1500	12.5 × 31.5	0.072	1982	B41042A5158M***
	1800	12.5 × 35.5	0.062	2080	B41042A5188M***
	2200	12.5 × 40	0.056	2361	B41042A5228M***
	2700	16 × 31.5	0.050	2471	B41042A5278M***
	3300	16 × 35.5	0.045	2662	B41042A5338M***
	3900	16 × 40	0.040	2821	B41042A5398M***
4700	18 × 40	0.036	2965	B41042A5478M***	

*** = Version
 000 = for standard leads, bulk
 001 = for kinked leads, bulk
 002 = for cut leads, bulk
 016 = for taped leads, Ammo pack, lead spacing a = 2.0 mm
 007 = for taped leads, Ammo pack, lead spacing a = 2.5 mm
 006 = for taped leads, Ammo pack, lead spacing a = 3.5 mm
 008 = for taped leads, Ammo pack, lead spacing a = 5.0 mm

Please read *Cautions and warnings* and
Important notes at the end of this document.

Technical data and ordering codes

V _R V DC	C _R 120 Hz 20 °C μF	Case dimensions d × l mm	Z _{max} 100 kHz 20 °C Ω	I _{AC,R} 100 kHz 105 °C mA	Ordering code (composition see below)
35	22	5 × 11	1.500	161	B41042A7226M***
	27	5 × 11	1.300	182	B41042A7276M***
	33	6.3 × 11	1.200	227	B41042A7336M***
	39	6.3 × 11	0.830	246	B41042A7396M***
	47	6.3 × 11	0.720	271	B41042A7476M***
	56	6.3 × 11	0.520	298	B41042A7566M***
	68	6.3 × 15	0.470	372	B41042A7686M***
	82	6.3 × 15	0.420	418	B41042A7826M***
	100	8 × 11.5	0.390	463	B41042A7107M***
	120	10 × 12.5	0.340	551	B41042A7127M***
	150	10 × 12.5	0.300	599	B41042A7157M***
	180	10 × 16	0.260	731	B41042A7187M***
	220	10 × 16	0.230	796	B41042A7227M***
	270	10 × 20	0.210	986	B41042A7277M***
	330	10 × 20	0.180	1061	B41042A7337M***
	390	10 × 25	0.150	1222	B41042A7397M***
	470	10 × 31.5	0.120	1423	B41042A7477M***
	560	12.5 × 20	0.100	1431	B41042A7567M***
	680	12.5 × 25	0.085	1663	B41042A7687M***
	820	12.5 × 25	0.075	1765	B41042A7827M***
	1000	12.5 × 31.5	0.068	1982	B41042A7108M***
	1200	12.5 × 35.5	0.062	2184	B41042A7128M***
	1500	12.5 × 40	0.056	2362	B41042A7158M***
	1800	16 × 31.5	0.050	2475	B41042A7188M***
2200	16 × 35.5	0.045	2684	B41042A7228M***	
2700	16 × 40	0.040	2903	B41042A7278M***	
3300	18 × 40	0.036	3041	B41042A7338M***	

*** = Version
 000 = for standard leads, bulk
 001 = for kinked leads, bulk
 002 = for cut leads, bulk
 016 = for taped leads, Ammo pack, lead spacing a = 2.0 mm
 007 = for taped leads, Ammo pack, lead spacing a = 2.5 mm
 006 = for taped leads, Ammo pack, lead spacing a = 3.5 mm
 008 = for taped leads, Ammo pack, lead spacing a = 5.0 mm

Technical data and ordering codes

V _R V DC	C _R 120 Hz 20 °C μF	Case dimensions d × l mm	Z _{max} 100 kHz 20 °C Ω	I _{AC,R} 100 kHz 105 °C mA	Ordering code (composition see below)
50	0.47	5 × 11	7.000	23	B41042A6474M***
	0.68	5 × 11	6.000	29	B41042A6684M***
	1.0	5 × 11	4.900	37	B41042A6105M***
	1.5	5 × 11	4.600	47	B41042A6155M***
	2.2	5 × 11	4.200	57	B41042A6225M***
	3.3	5 × 11	3.900	68	B41042A6335M***
	4.7	5 × 11	3.600	82	B41042A6475M***
	6.8	5 × 11	3.200	93	B41042A6685M***
	10	5 × 11	2.700	116	B41042A6106M***
	12	5 × 11	2.500	127	B41042A6126M***
	15	5 × 11	2.300	148	B41042A6156M***
	18	5 × 11	2.100	157	B41042A6186M***
	22	6.3 × 11	1.900	196	B41042A6226M***
	27	6.3 × 11	1.500	216	B41042A6276M***
	33	6.3 × 11	1.100	241	B41042A6336M***
	39	6.3 × 11	1.000	263	B41042A6396M***
	47	6.3 × 15	0.900	332	B41042A6476M***
	56	6.3 × 15	0.800	361	B41042A6566M***
	68	8 × 11.5	0.700	415	B41042A6686M***
	82	10 × 12.5	0.600	501	B41042A6826M***
	100	10 × 16	0.500	623	B41042A6107M***
	120	10 × 16	0.420	675	B41042A6127M***
	150	10 × 20	0.350	821	B41042A6157M***
	180	10 × 20	0.310	893	B41042A6187M***
	220	10 × 25	0.270	1045	B41042A6227M***
	270	10 × 31.5	0.220	1203	B41042A6277M***
	330	10 × 31.5	0.180	1305	B41042A6337M***
	390	12.5 × 25	0.150	1441	B41042A6397M***
	470	12.5 × 25	0.120	1506	B41042A6477M***
	560	12.5 × 31.5	0.110	1682	B41042A6567M***
	680	12.5 × 35.5	0.094	1853	B41042A6687M***

*** = Version
 000 = for standard leads, bulk
 001 = for kinked leads, bulk
 002 = for cut leads, bulk
 016 = for taped leads, Ammo pack, lead spacing a = 2.0 mm
 007 = for taped leads, Ammo pack, lead spacing a = 2.5 mm
 006 = for taped leads, Ammo pack, lead spacing a = 3.5 mm
 008 = for taped leads, Ammo pack, lead spacing a = 5.0 mm

Single-ended capacitors
Low impedance – 105 °C

B41042

Technical data and ordering codes

V _R	C _R 120 Hz 20 °C μF	Case dimensions d × l mm	Z _{max} 100 kHz 20 °C Ω	I _{AC,R} 100 kHz 105 °C mA	Ordering code (composition see below)
50	820	12.5 × 40	0.088	2017	B41042A6827M***
	1000	16 × 31.5	0.076	2123	B41042A6108M***
	1200	16 × 35.5	0.072	2264	B41042A6128M***
	1500	16 × 40	0.065	2411	B41042A6158M***
	1800	18 × 35.5	0.058	2463	B41042A6188M***
	2200	18 × 40	0.050	2562	B41042A6228M***
63	10	5 × 11	3.600	136	B41042A8106M***
	12	5 × 11	3.200	147	B41042A8126M***
	15	6.3 × 11	2.800	185	B41042A8156M***
	18	6.3 × 11	2.400	199	B41042A8186M***
	22	6.3 × 11	2.100	217	B41042A8226M***
	27	6.3 × 11	1.900	242	B41042A8276M***
	33	6.3 × 15	1.700	306	B41042A8336M***
	39	6.3 × 15	1.500	332	B41042A8396M***
	47	8 × 11.5	1.200	367	B41042A8476M***
	56	10 × 12.5	1.100	451	B41042A8566M***
	68	10 × 12.5	0.900	503	B41042A8686M***
	82	10 × 16	0.800	605	B41042A8826M***
	100	10 × 20	0.650	751	B41042A8107M***
	120	10 × 20	0.580	823	B41042A8127M***
	150	10 × 25	0.520	954	B41042A8157M***
	180	10 × 31.5	0.420	1113	B41042A8187M***
	220	12.5 × 20	0.320	1142	B41042A8227M***
	270	12.5 × 25	0.280	1345	B41042A8277M***
	330	12.5 × 25	0.220	1421	B41042A8337M***
	390	12.5 × 31.5	0.190	1623	B41042A8397M***
	470	12.5 × 35.5	0.160	1785	B41042A8477M***
	560	12.5 × 40	0.140	1952	B41042A8567M***
	680	16 × 31.5	0.120	2053	B41042A8687M***
	820	16 × 35.5	0.110	2223	B41042A8827M***
1000	16 × 40	0.098	2374	B41042A8108M***	
1200	18 × 40	0.088	2511	B41042A8128M***	

*** = Version
 000 = for standard leads, bulk
 001 = for kinked leads, bulk
 002 = for cut leads, bulk
 016 = for taped leads, Ammo pack, lead spacing a = 2.0 mm
 007 = for taped leads, Ammo pack, lead spacing a = 2.5 mm
 006 = for taped leads, Ammo pack, lead spacing a = 3.5 mm
 008 = for taped leads, Ammo pack, lead spacing a = 5.0 mm

Please read *Cautions and warnings* and
Important notes at the end of this document.

Technical data and ordering codes

V _R V DC	C _R 120 Hz 20 °C μF	Case dimensions d × l mm	Z _{max} 100 kHz 20 °C Ω	I _{AC,R} 100 kHz 105 °C mA	Ordering code (composition see below)
80	4.7	5 × 11	8.500	92	B41042A0475M***
	6.8	5 × 11	5.500	111	B41042A0685M***
	10	6.3 × 11	3.800	152	B41042A0106M***
	12	6.3 × 11	3.400	164	B41042A0126M***
	15	6.3 × 11	3.000	189	B41042A0156M***
	18	6.3 × 11	2.600	205	B41042A0186M***
	22	6.3 × 15	2.200	226	B41042A0226M***
	27	6.3 × 15	2.000	256	B41042A0276M***
	33	8 × 11.5	1.800	307	B41042A0336M***
	39	10 × 12.5	1.600	381	B41042A0396M***
	47	10 × 12.5	1.300	410	B41042A0476M***
	56	10 × 16	1.200	510	B41042A0566M***
	68	10 × 20	1.000	636	B41042A0686M***
	82	10 × 20	0.850	676	B41042A0826M***
	100	10 × 25	0.700	839	B41042A0107M***
	120	10 × 31.5	0.620	1032	B41042A0127M***
	150	10 × 31.5	0.550	1070	B41042A0157M***
	180	12.5 × 25	0.450	1115	B41042A0187M***
	220	12.5 × 31.5	0.350	1433	B41042A0227M***
	270	12.5 × 31.5	0.300	1509	B41042A0277M***
330	12.5 × 35.5	0.240	1693	B41042A0337M***	
390	12.5 × 40	0.200	1828	B41042A0397M***	
470	16 × 31.5	0.170	1902	B41042A0477M***	
560	16 × 35.5	0.150	2080	B41042A0567M***	
680	16 × 40	0.130	2313	B41042A0687M***	
820	18 × 35.5	0.120	2357	B41042A0827M***	
1000	18 × 40	0.100	2518	B41042A0108M***	

*** = Version
 000 = for standard leads, bulk
 001 = for kinked leads, bulk
 002 = for cut leads, bulk
 016 = for taped leads, Ammo pack, lead spacing a = 2.0 mm
 007 = for taped leads, Ammo pack, lead spacing a = 2.5 mm
 006 = for taped leads, Ammo pack, lead spacing a = 3.5 mm
 008 = for taped leads, Ammo pack, lead spacing a = 5.0 mm

Taping, packing and lead configurations of single-ended capacitors

Single-ended capacitors are available taped in Ammo pack from diameter 4 to 10 mm as follows:

Lead spacing 2.0 mm ($\varnothing d = 4 \dots 5$ mm)

Last 3 digits of ordering code: 016

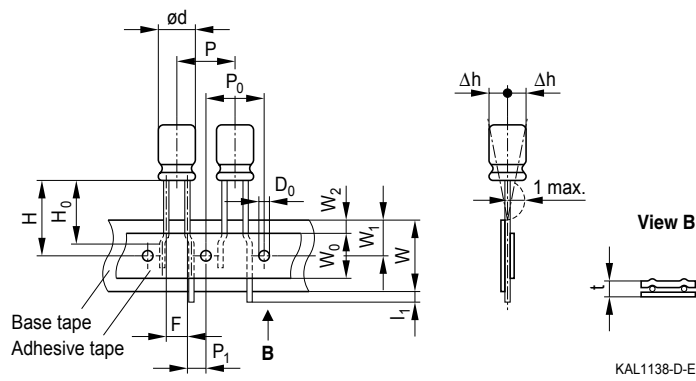
Dimensions in mm

$\varnothing d$	F	H	W	W_0	W_1	W_2	P	P_0	P_1	l_1	t	Δh	D_0
4 ... 5	2.0	18.5	18.0	7.0	9.0	3.0	12.7	12.7	5.10	1.0	0.7	1	4.0
	-0.2	± 0.75	± 0.5	min.	± 0.5	max.	± 1.0	± 0.3	± 0.7	max.	± 0.2	± 1.0	± 0.2

Lead spacing 2.5 mm ($\varnothing d = 4 \dots 6.3$ mm)

Last 3 digits of ordering code: 007

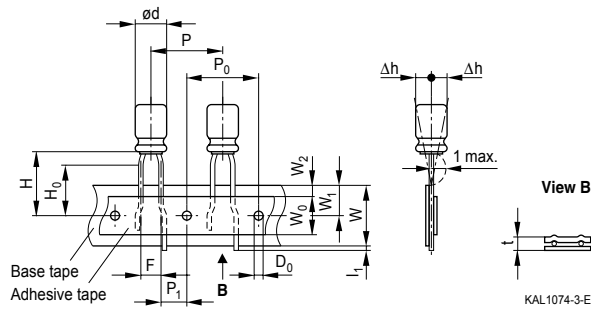
Dimensions in mm

$\varnothing d$	F	H	H ₀	W	W ₀	W ₁	W ₂	P	P ₀	P ₁	l ₁	t	Δh	D ₀
4 ... 6.3	2.5	18.5	16.0	18.0	7.0	9.0	3.0	12.7	12.7	5.10	1.0	0.7	0	4.0
Tolerance	-0.2	± 0.75	± 0.5	± 0.5	min.	± 0.5	max.	± 1.0	± 0.3	± 0.7	max.	± 0.2	± 1.0	± 0.2

Lead spacing 3.5 mm ($\varnothing d = 8$ mm)

Last 3 digits of ordering code: 006

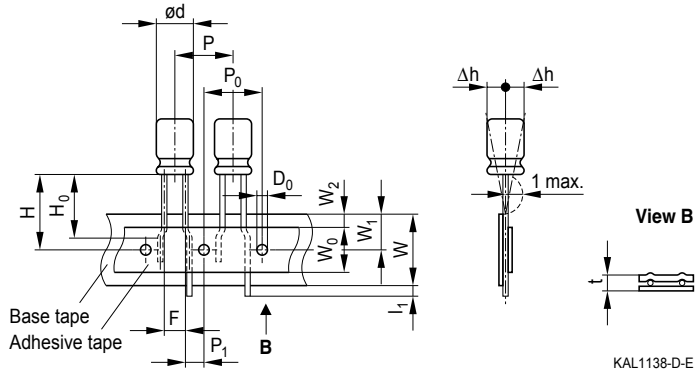

Dimensions in mm

$\varnothing d$	F	H	W	W ₀	W ₁	W ₂	P	P ₀	P ₁	l ₁	t	Δh	D ₀
8	3.5	18.5	18.0	10	9.0	3.0	12.7	12.7	5.10	1.0	0.7	1	4.0
Tolerance	± 0.5	± 0.75	± 0.5	min.	± 0.5	max.	± 1.0	± 0.3	± 0.7	max.	± 0.2	max.	± 0.2

 Please read *Cautions and warnings* and *Important notes* at the end of this document.

Lead spacing 5.0 mm ($\varnothing d = 4 \dots 8$ mm)

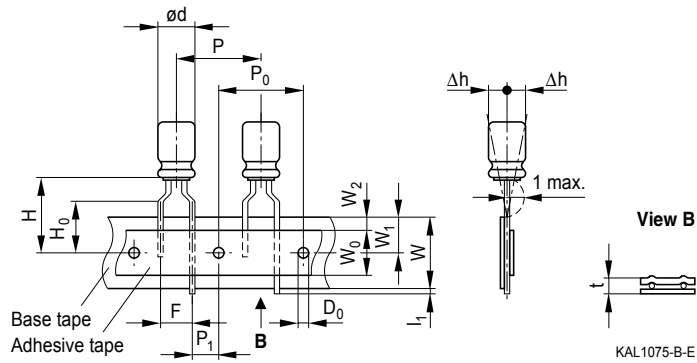
Last 3 digits of ordering code: 008



Lead spacing 5.0 mm ($\varnothing d = 10$ mm)

Last 3 digits of ordering code: 008

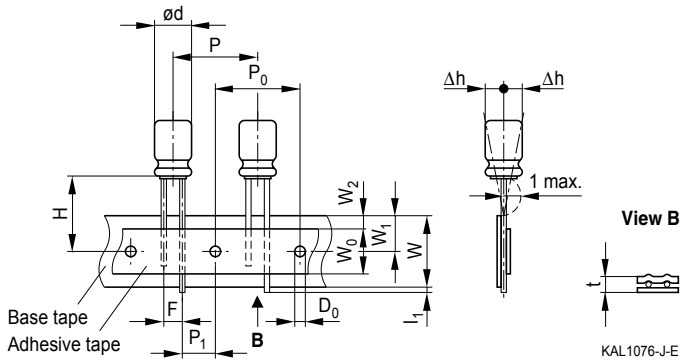

Dimensions in mm

$\varnothing d$	F	H	H ₀	W	W ₀	W ₁	W ₂	P	P ₀	P ₁	L ₁	t	Δh	D ₀
4 ... 6.3	5.0	18.5	16	18.0	7.0	9.0	3.0	12.7	12.7	3.85	1.0	0.6	2.0	4.0
8	5.0	18.5	16	18.0	10	9.0	3.0	12.7	12.7	3.85	1.0	0.6	2.0	4.0
10	5.0	18.5	—	18.0	12.5	9.0	3.0	12.7	12.7	3.85	1.0	0.6	2.0	4.0
Tolerance	+0.6 -0.2	±0.75	±0.5	+1.0 -0.5	+1.0 -0	±0.5	max.	±0.5	±0.3	±0.7	max.	+0.3 -0.2	max.	±0.2

Taping is available up to dimensions $d \times l = 10 \times 20$ mm. For $\varnothing 12.5$, 16 and 18 mm taping is not available.

Please read *Cautions and warnings* and *Important notes* at the end of this document.

Kinked or cut leads

Single-ended capacitors are available with kinked or cut leads. Other lead configurations also available on request.

Kinked leads

Last 3 digits of ordering code: 001

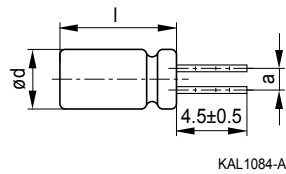
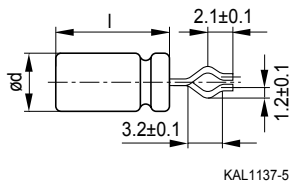

Case size d × l (mm)	a (mm)
4 × 7	1.5
5 × 7	2.0
5 × 11	2.0
6.3 × 7	2.5
6.3 × 11	2.5
6.3 × 15	2.5
8 × 7	3.5
8 × 11.5	3.5
8 × 15	3.5
8 × 20	3.5
10 × 12.5	5.0
10 × 16	5.0
10 × 20	5.0
10 × 25	5.0
10 × 31.5	5.0

Case size d × l (mm)	a (mm)
12.5 × 16	5.0
12.5 × 20	5.0
12.5 × 25	5.0
12.5 × 31.5	5.0
12.5 × 35.5	5.0
12.5 × 40	5.0
16 × 20	7.5
16 × 25	7.5
16 × 31.5	7.5
16 × 35.5	7.5
16 × 40	7.5
18 × 20	7.5
18 × 25	7.5
18 × 31.5	7.5
18 × 35.5	7.5
18 × 40	7.5

Please read *Cautions and warnings* and *Important notes* at the end of this document.

Cut leads

Last 3 digits of ordering code: 002

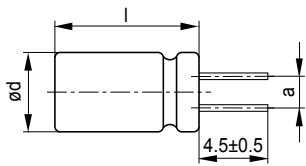

KAL1086-R

Case size $d \times l$ (mm)	a (mm)
4 × 7	1.5
5 × 7	2.0
5 × 11	2.0
6.3 × 7	2.5
6.3 × 11	2.5
6.3 × 15	2.5
8 × 7	3.5
8 × 11.5	3.5
8 × 15	3.5
8 × 20	5.0
10 × 12.5	5.0
10 × 16	5.0
10 × 20	5.0
10 × 25	5.0
10 × 31.5	5.0

Case size $d \times l$ (mm)	a (mm)
12.5 × 16	5.0
12.5 × 20	5.0
12.5 × 25	5.0
12.5 × 31.5	5.0
12.5 × 35.5	5.0
12.5 × 40	5.0
16 × 20	7.5
16 × 25	7.5
16 × 31.5	7.5
16 × 35.5	7.5
16 × 40	7.5
18 × 20	7.5
18 × 25	7.5
18 × 31.5	7.5
18 × 35.5	7.5
18 × 40	7.5

Cautions and warnings

General

Also see "Important notes" on page 23.

- 1 Aluminum electrolytic capacitors have a bi-polar structure. This is marked on the body of the capacitor. A capacitor must not be mounted with reversed polarity. The application of an AC or reverse voltage may cause a short circuit or damage the capacitor. Bi-polar capacitors must not be used in AC applications, where the polarity may be reversed in the circuits or is unknown.
- 2 The DC voltage applied to the capacitor terminal must not exceed its rated operating voltage, as this will result in a rapid increase of the leakage current and may damage the capacitor. It is recommended to operate the capacitor at 70–80% of its rated voltage to optimize its service life.
- 3 The ripple current applied to the capacitor must be within the permitted range. An excessive ripple current leads to impaired electrical properties and may damage the capacitor. Note that the sum of the peak values of the ripple voltage and the DC operating voltage must not exceed the rated DC voltage.
- 4 Capacitors must be used within their permitted range of operating temperature. Operation at room temperature optimizes their service life.
- 5 Capacitors with case diameter ≥ 8 mm are equipped with a safety vent. In capacitors fitted with a lead or soldering lug, the safety vent is usually located at the base of the case. It needs sufficient space around it to operate optimally. The following dimensions are recommended: for case diameter $d = 8$ to 16 mm, more than 2 mm; for $d = 18$ to 35 mm, more than 3 mm; and for $d = 42$ mm or more, more than 5 mm.
- 6 Capacitors should not be mounted with the safety vent face down on the board. Do not locate any wire or copper trace near the safety vent. Do not reverse the voltage, as this may result in excess pressure and the leakage of electrolyte.
- 7 Gas is released through the safety vent when the pressure inside the capacitor is too high. A gaseous liquid around the safety vent does not indicate a leakage of electrolyte.
- 8 The capacitor should be stored under conditions of normal temperature and in a non-acid, non-alkali environment of normal humidity. Exposure to high temperatures, for example under direct sunlight, will reduce its operating life. If the capacitor is stored in an environment containing acids or alkalis, the solderability of the leads may be affected.
- 9 The leakage current of an aluminum electrolytic capacitor may increase after a long period of storage. After such storage, the capacitor must be aged by applying the rated operating voltage for 6–8 hours before use.
- 10 Manual soldering:
 - a Soldering must be performed within the specified conditions.
Bit temperature: 350 °C; application time of soldering iron: 3 seconds.
 - b Ensure that the soldering iron does not touch any part of the capacitor body.

Cautions and warnings

- 11 Do not apply excessive force to the leads and terminals. Do not move the capacitor after soldering it onto the PC board and do not carry the PC board by gripping the capacitor. Observe the following rules to prevent undue stress to the capacitor:
 - a Do not tilt or bend the capacitor after soldering.
 - b Ensure that the terminal spacing matches the corresponding hole spacing on the PC board.
- 12 The aluminum case is not insulated from the cathode. Do not place a conductor under the aluminum capacitors on the PC board as this may cause a short circuit. The case and top of capacitors used in switched mode power supplies have a high-voltage-resistant heat shrink sleeve to ensure safe usage.
- 13 The leads of capacitors with a case diameter exceeding 14 mm cannot be used for fixing.

Important notes

The following applies to all products named in this publication:



1. Some parts of this publication contain **statements about the suitability of our products for certain areas of application**. These statements are based on our knowledge of typical requirements that are often placed on our products in the areas of application concerned. We nevertheless expressly point out **that such statements cannot be regarded as binding statements about the suitability of our products for a particular customer application**. As a rule we are either unfamiliar with individual customer applications or less familiar with them than the customers themselves. For these reasons, it is always ultimately incumbent on the customer to check and decide whether a product with the properties described in the product specification is suitable for use in a particular customer application.
2. We also point out that **in individual cases, a malfunction of electronic components or failure before the end of their usual service life cannot be completely ruled out in the current state of the art, even if they are operated as specified**. In customer applications requiring a very high level of operational safety and especially in customer applications in which the malfunction or failure of an electronic component could endanger human life or health (e.g. in accident prevention or life-saving systems), it must therefore be ensured by means of suitable design of the customer application or other action taken by the customer (e.g. installation of protective circuitry or redundancy) that no injury or damage is sustained by third parties in the event of malfunction or failure of an electronic component.
3. **The warnings, cautions and product-specific notes must be observed.**
4. In order to satisfy certain technical requirements, **some of the products described in this publication may contain substances subject to restrictions in certain jurisdictions (e.g. because they are classed as hazardous)**. Useful information on this will be found in our Material Data Sheets on the Internet (www.tdk-electronics.tdk.com/material). Should you have any more detailed questions, please contact our sales offices.
5. We constantly strive to improve our products. Consequently, **the products described in this publication may change from time to time**. The same is true of the corresponding product specifications. Please check therefore to what extent product descriptions and specifications contained in this publication are still applicable before or when you place an order.

We also **reserve the right to discontinue production and delivery of products**. Consequently, we cannot guarantee that all products named in this publication will always be available. The aforementioned does not apply in the case of individual agreements deviating from the foregoing for customer-specific products.
6. Unless otherwise agreed in individual contracts, **all orders are subject to our General Terms and Conditions of Supply**.
7. **Our manufacturing sites serving the automotive business apply the IATF 16949 standard**. The IATF certifications confirm our compliance with requirements regarding the quality management system in the automotive industry. Referring to customer requirements and customer specific requirements ("CSR") TDK always has and will continue to have the policy of respecting individual agreements. Even if IATF 16949 may appear to support the acceptance of unilateral requirements, we hereby like to emphasize that **only requirements mutually agreed upon can and will be implemented in our Quality Management System**. For clarification purposes we like to point out that obligations from IATF 16949 shall only become legally binding if individually agreed upon.
8. The trade names EPCOS, CeraCharge, CeraDiode, CeraLink, CeraPad, CeraPlas, CSMP, CTVS, DeltaCap, DigiSiMic, ExoCore, FilterCap, FormFit, LeaXield, MiniBlue, MiniCell, MKD, MKK, MotorCap, PCC, PhaseCap, PhaseCube, PhaseMod, PhiCap, PowerHap, PQSine, PQvar, SIFERRIT, SIFI, SIKOREL, SilverCap, SIMDAD, SiMic, SIMID, SineFormer, SIOV, ThermoFuse, WindCap are **trademarks registered or pending** in Europe and in other countries. Further information will be found on the Internet at www.tdk-electronics.tdk.com/trademarks.





Release 2018-10

Looking for pricing, stock, or lifecycle information?

Click below to explore more details on WIN SOURCE:

-  [View B41042A3187M on WIN SOURCE](#)
-  [EPCOS \(TDK\) Information](#)

Optimize Your Supply Chain with WIN SOURCE Solutions

-  Global Sourcing Solution
-  Obsolete Management
-  Cost Control Management
-  Shortage Management
-  Alternative Solution
-  Excess Inventory Management