



THE DATASHEET OF HMC626LP5E



Typical Applications

The HMC626LP5(E) is ideal for:

- IF & RF Applications
- Cellular/3G Infrastructure
- WiBro / WiMAX / 4G
- Microwave Radio & VSAT
- Test Equipment and Sensors

Features

- +8.5 dB to +40 dB Gain Control in 0.5 dB Steps
- High Output IP3: +36 dBm
- ±0.25 dB Typical Gain Step Error
- Single +5V Supply
- 32 Lead 5x5mm SMT Package: 25mm²

Functional Diagram

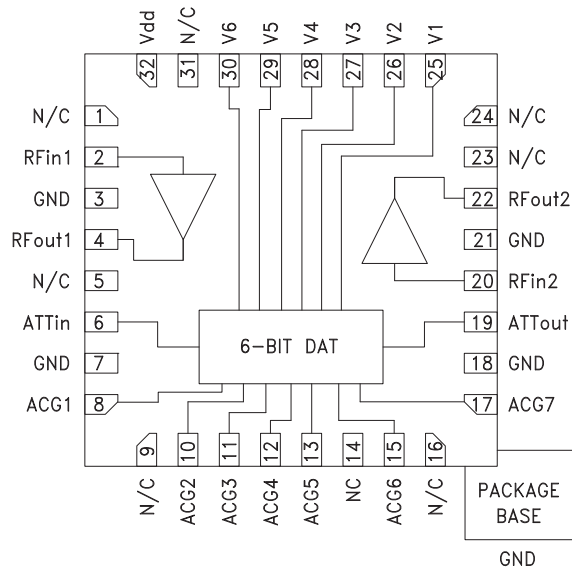

General Description

The HMC626LP5(E) is a digitally controlled variable gain amplifier which operates from DC to 1 GHz, and can be programmed to provide anywhere from 8.5 dB, to 40 dB of gain, in 0.5 dB steps. The HMC626LP5(E) delivers noise figure of 2.8 dB in its maximum gain state, with output IP3 of up to +36 dBm in any state. This single positive control line per bit digital VGA incorporates off chip AC ground capacitors for near DC operation, making it suitable for a wide variety of RF and IF applications. The HMC626LP5(E) is housed in a RoHS compliant 5x5 mm QFN leadless package, and requires no external matching components. A serial control version of this product is available as the HMC681LP5(E).

Electrical Specifications, $T_A = +25^\circ C$, $V_{dd} = V_s = +5V$, $V_{ctl} = 0 / +5V$

| Parameter | Frequency | Min. | Typ. | Max. | Units |
|--|---------------|---|------|------|-------|
| Gain (Maximum Gain State) | DC - 0.5 GHz | 37 | 42.5 | | dB |
| | 0.5 - 1.0 GHz | 30 | 35.0 | | dB |
| Gain Control Range | | | 31.5 | | dB |
| Input Return Loss | | | 20 | | dB |
| Output Return Loss | | | 15 | | dB |
| Gain Setting Accuracy: (Referenced to Maximum Gain State) All Gain States | 0.5 - 1.0 GHz | ± (0.15 + 3% of Relative Gain Setting) Max. | | | dB |
| Output Power for 1 dB Compression | DC - 1.0 GHz | | 20 | | dBm |
| Output Third Order Intercept Point (Two-Tone Output Power= 5 dBm Each Tone) | DC - 1.0 GHz | | 36 | | dBm |
| Noise Figure | DC - 1.0 GHz | | 2.8 | | dB |
| Switching Characteristics | | | | | |
| tRISE, tFALL (10/90% RF) | DC - 1.0 GHz | | 130 | | ns |
| tON, tOFF (50% CTL to 10/90% RF) | | | 140 | | ns |
| Total Supply Current | DC - 1.0 GHz | | 176 | 225 | mA |

For price, delivery, and to place orders, please contact Hittite Microwave Corporation:
 20 Alpha Road, Chelmsford, MA 01824 Phone: 978-250-3343 Fax: 978-250-3373
 Order On-line at www.hittite.com

**0.5 dB LSB GaAs MMIC 6-BIT DIGITAL
VARIABLE GAIN AMPLIFIER, DC - 1 GHz**

Gain vs. Frequency^[1]

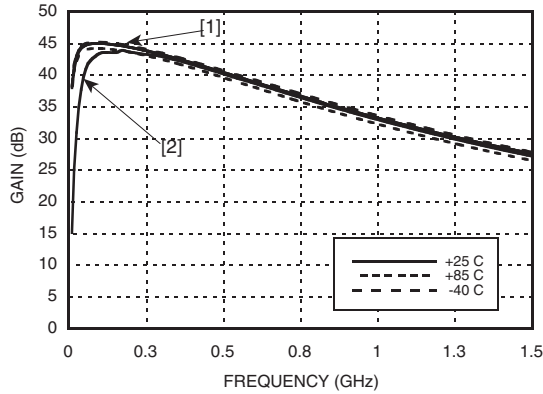

Relative Gain Setting

(Referenced to Maximum Gain State)
(Only Major States are Shown)

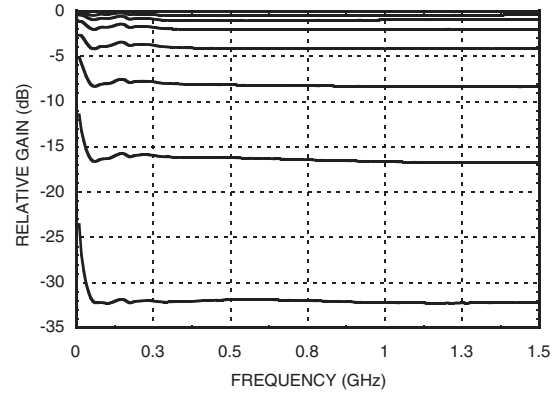

Input Return Loss^[1]

(Only Major States are Shown)

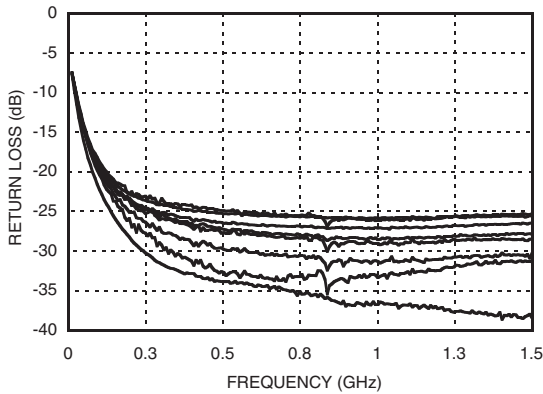

Output Return Loss^[1]

(Only Major States are Shown)

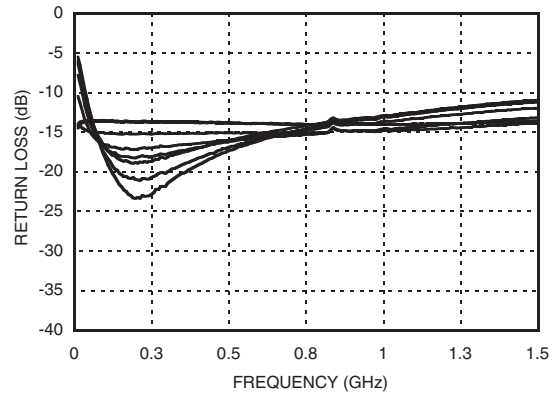

Input Return Loss^[2]

(Only Major States are Shown)

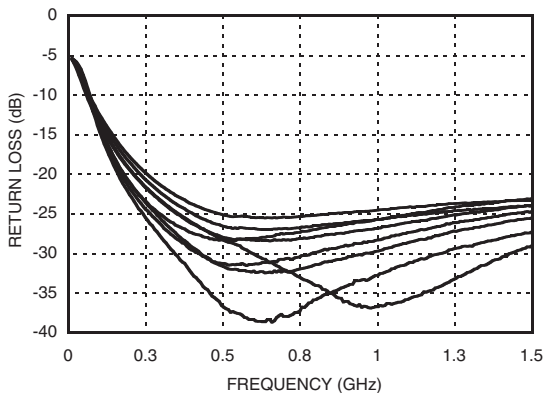

Output Return Loss^[2]

(Only Major States are Shown)

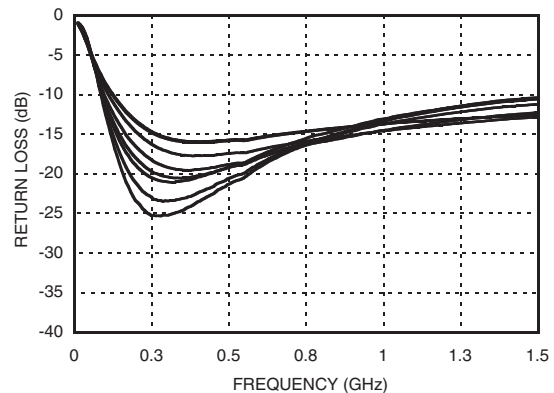

[1] Tested with broadband bias tee on output J2, C7, C8 = 10,000pF ; L1 = 680nH

[2] Data taken on eval board as described in data sheet



**0.5 dB LSB GaAs MMIC 6-BIT DIGITAL
VARIABLE GAIN AMPLIFIER, DC - 1 GHz**

Bit Error vs. Frequency^[2]
(Only Major States are Shown)

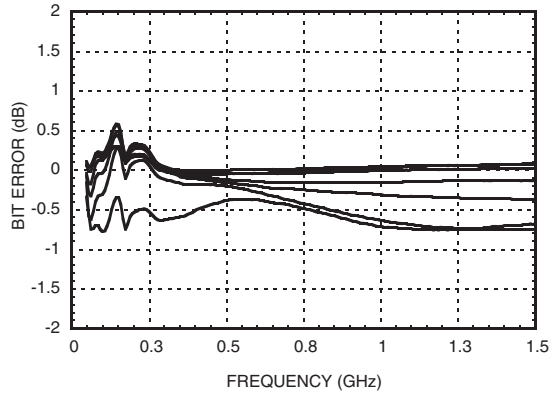

Bit Error vs. Relative Gain Setting^[2]

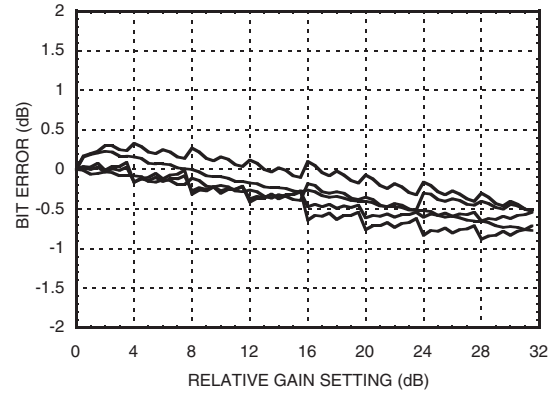

Relative Phase vs. Frequency^[2]
(Only Major States are Shown)

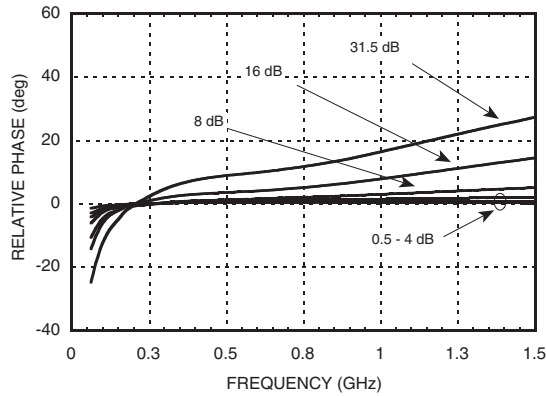

Step Error vs. Frequency^[2]
(Only Major States are Shown)

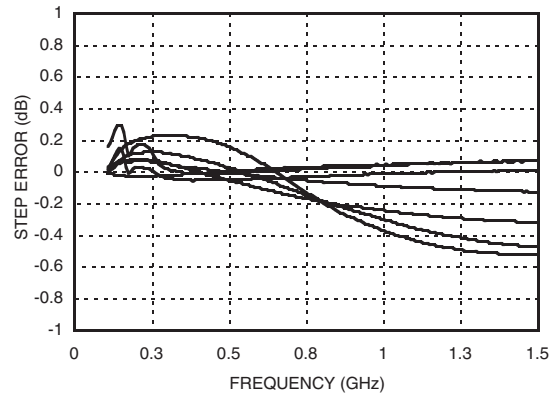

[1] Tested with broadband bias tee on output J2, C7, C8 = 10,000pF ; L1 = 680nH

[2] Data taken on eval board as described in data sheet



0.5 dB LSB GaAs MMIC 6-BIT DIGITAL VARIABLE GAIN AMPLIFIER, DC - 1 GHz

Bias Voltage & Current

| Vdd (V) | Idd (Typ.) (mA) |
|---------|-----------------|
| +4.5 | 4.7 |
| +5.0 | 5.0 |
| +5.5 | 5.3 |
| Vs (V) | Is (mA) |
| +5.0 | 176 |

Control Voltage Table

| State | Vdd = +3V | Vdd = +5V |
|-------|-------------------|-------------------|
| Low | 0 to 0.5V @ <1 μA | 0 to 0.8V @ <1 μA |
| High | 2 to 3V @ <1 μA | 2 to 5V @ <1 μA |

Truth Table

| Control Voltage Input | | | | | | Relative Gain Setting |
|-----------------------|-----------|------------|------------|------------|--------------|-----------------------|
| V1 16 dB | V2 8dB | V3 4 dB | V4 2 dB | V5 1 dB | V6 0.5 dB | |
| High | High | High | High | High | High | Reference 0 dB |
| High | High | High | High | High | Low | -0.5 dB |
| High | High | High | High | Low | High | -1 dB |
| High | High | High | Low | High | High | -2 dB |
| High | High | Low | High | High | High | -4 dB |
| High | Low | High | High | High | High | -8 dB |
| Low | High | High | High | High | High | -16 dB |
| Low | Low | Low | Low | Low | Low | -31.5 dB |

Any combination of the above states will provide a relative gain setting approximately equal to the sum of the bits selected.

0.5 dB LSB GaAs MMIC 6-BIT DIGITAL VARIABLE GAIN AMPLIFIER, DC - 1 GHz

Absolute Maximum Ratings

| | |
|--|------------------------|
| RF Input Power ^[1] (At Max Gain Setting) | -10.5 dBm (T = +85 °C) |
| Bias Voltage (Vdd) | +5.5 Vdc |
| Collector Bias Voltage (Vcc) | 5.5 Vdc |
| Channel/Junction Temperature | 150 °C |
| Continuous Pdiss (T = 85 °C) (derate 19.8 mW/°C above 85 °C) ^[1] | 1.29 W |
| Thermal Resistance | 50.8 °C/W |
| Storage Temperature | -65 to +150 °C |
| Operating Temperature | -40 to +85 °C |



ELECTROSTATIC SENSITIVE DEVICE
OBSERVE HANDLING PRECAUTIONS

[1] The Max RF Input Power Rating will increase by 0.5 dB for every 0.5 dB reduction in gain to a maximum RF Input Power of 10 dBm.

Outline Drawing

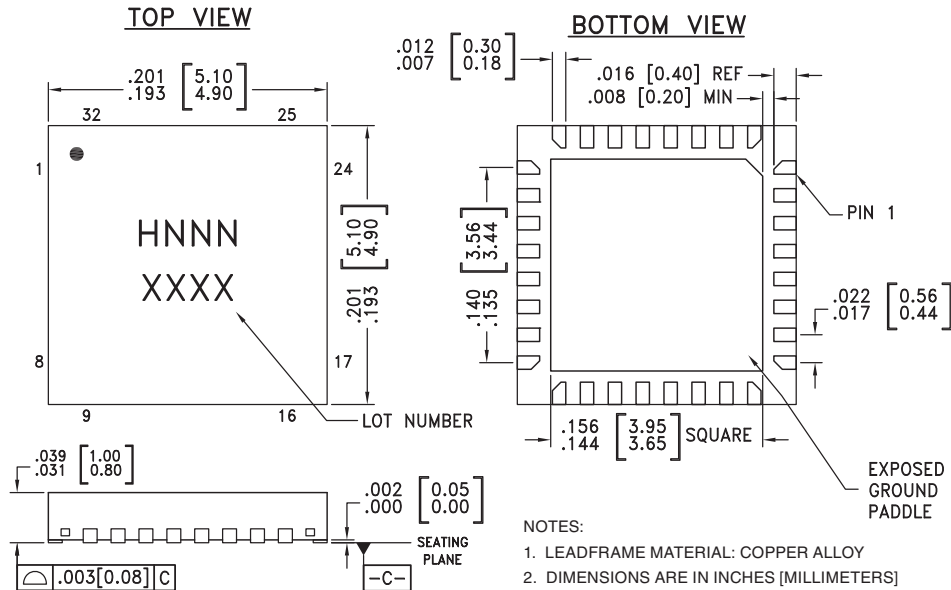

NOTES:

1. LEADFRAME MATERIAL: COPPER ALLOY
2. DIMENSIONS ARE IN INCHES [MILLIMETERS]
3. LEAD SPACING TOLERANCE IS NON-CUMULATIVE.
4. PAD BURR LENGTH SHALL BE 0.15mm MAXIMUM.
PAD BURR HEIGHT SHALL BE 0.05mm MAXIMUM.
5. PACKAGE WARP SHALL NOT EXCEED 0.05mm.
6. ALL GROUND LEADS AND GROUND PADDLE MUST BE SOLDERED TO PCB RF GROUND.
7. REFER TO HITTITE APPLICATION NOTE FOR SUGGESTED LAND PATTERN.

Package Information

| Part Number | Package Body Material | Lead Finish | MSL Rating | Package Marking ^[3] |
|-------------|--|---------------|---------------------|--------------------------------|
| HMC626LP5 | Low Stress Injection Molded Plastic | Sn/Pb Solder | MSL1 ^[1] | H626 XXXX |
| HMC626LP5E | RoHS-compliant Low Stress Injection Molded Plastic | 100% matte Sn | MSL1 ^[2] | H626 XXXX |

[1] Max peak reflow temperature of 235 °C



[2] Max peak reflow temperature of 260 °C

[3] 4-Digit lot number XXXX

For price, delivery, and to place orders, please contact Hittite Microwave Corporation:
20 Alpha Road, Chelmsford, MA 01824 Phone: 978-250-3343 Fax: 978-250-3373
Order On-line at www.hittite.com

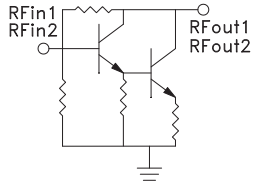

Pin Descriptions

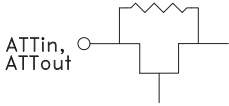
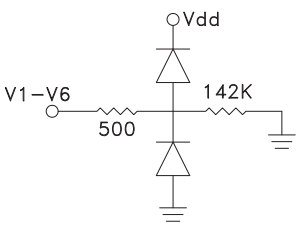
| Pin Number | Function | Description | Interface Schematic |
|-----------------------------|--|--|---|
| 1, 5, 9, 14, 16, 23, 24, 31 | N/C | These pins may be connected to RF/DC ground. Performance will not be affected. | |
| 2, 20 | RFin1, RFin2 | This pin is DC coupled. An off chip DC blocking capacitor is required. |  |
| 4, 22 | RFout1, RFout2 | RF output and DC bias (Vcc) for the output stage of the amplifiers. Amplifier bias provided via external bias tee as shown in application circuit. | |
| 3, 7, 18, 21 | GND | These pins and package bottom must be connected to RF/DC ground. |  |
| 6, 19 | ATTin, ATTout | These pins are DC coupled and matched to 50 Ohms. Blocking capacitors are required. Select value based on lowest frequency of operation. |  |
| 8, 10, 11, 12, 13, 15, 17 | ACG1, ACG2, ACG3, ACG4, ACG5, ACG6, ACG7 | External capacitors to ground is required. Select value for lowest frequency of operation. Place capacitor as close to pins as possible. | |
| 25 - 30 | V1 - V6 | See truth table, control voltage table and timing diagram. |  |
| 32 | Vdd | Supply voltage | |



0.5 dB LSB GaAs MMIC 6-BIT DIGITAL VARIABLE GAIN AMPLIFIER, DC - 1 GHz

Application Circuit

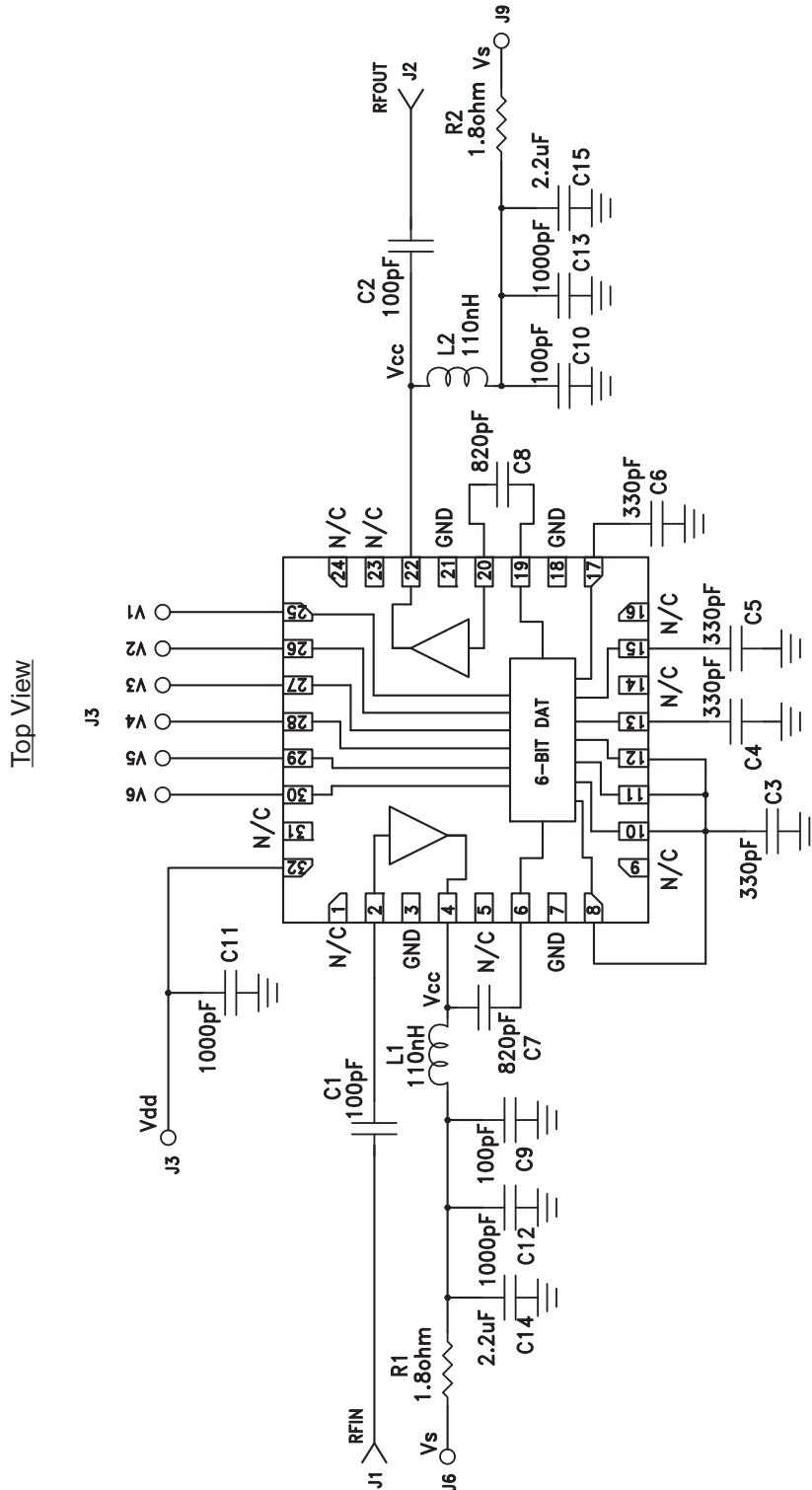



0.5 dB LSB GaAs MMIC 6-BIT DIGITAL VARIABLE GAIN AMPLIFIER, DC - 1 GHz

Evaluation PCB

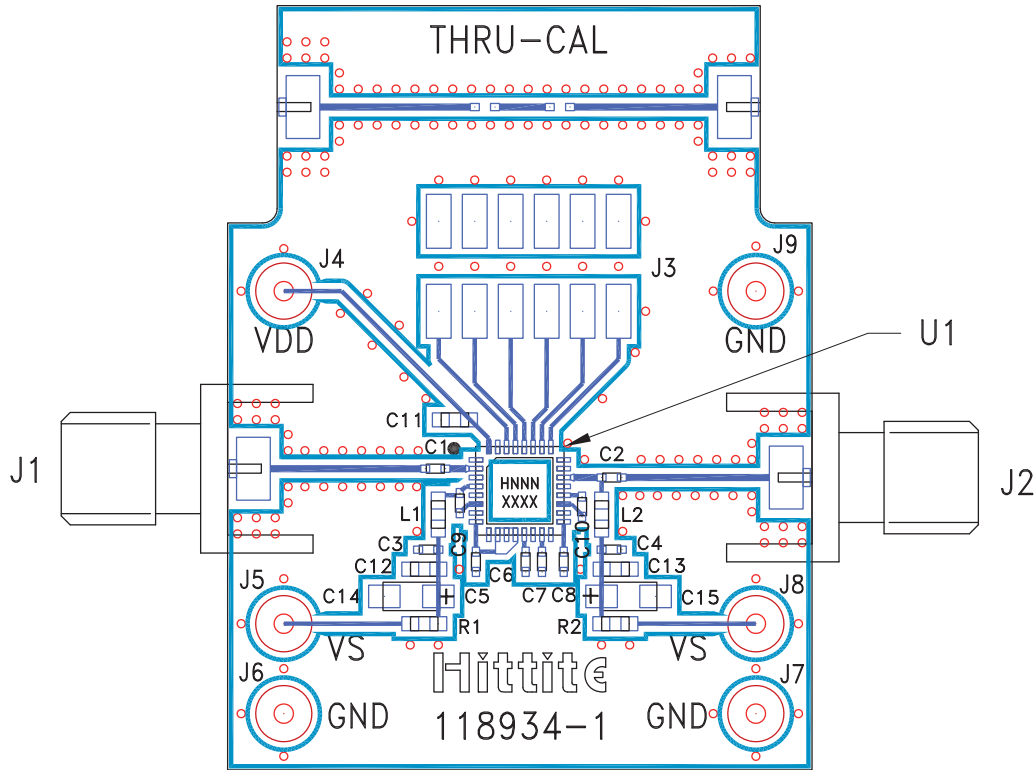

List of Materials for Evaluation PCB 117355 [1]

| Item | Description |
|-----------------|--------------------------------------|
| J1 - J2 | PCB Mount SMA Connector |
| J3 | 12 Pin DC Connector |
| J4 - J9 | DC Pin |
| C1, C2, C9, C10 | 820 pF Capacitor, 0402 Pkg. |
| C3, C4 | 100 pF Capacitor, 0402 Pkg. |
| C5 - C8 | 330 pF Capacitor, 0402 Pkg. |
| C11 - C13 | 1000 pF Capacitor, 0402 Pkg. |
| C14, C15 | 2.2 μ F Capacitor, CASE A Pkg. |
| R1, R2 | 1.8 Ohm Resistor, 0603 Pkg. |
| L1, L2 | 110 nH Inductor, 0603 Pkg. |
| U1 | HMC626LP5(E) Variable Gain Amplifier |
| PCB [2] | 118934 Evaluation PCB |



[1] Reference this number when ordering complete evaluation PCB

[2] Circuit Board Material: Arlon 25FR

The circuit board used in the final application should use RF circuit design techniques. Signal lines should have 50 ohm impedance while the package ground leads and exposed paddle should be connected directly to the ground plane similar to that shown. A sufficient number of via holes should be used to connect the top and bottom ground planes. The evaluation circuit board shown is available from Hittite upon request.

Looking for pricing, stock, or lifecycle information?

Click below to explore more details on WIN SOURCE:

-  [View HMC626LP5E on WIN SOURCE](#)
-  [Analog Devices Inc. Information](#)

Optimize Your Supply Chain with WIN SOURCE Solutions

-  Global Sourcing Solution
-  Obsolete Management
-  Cost Control Management
-  Shortage Management
-  Alternative Solution
-  Excess Inventory Management