



**THE DATASHEET OF  
TPS2513ADBVT**



## TPS251xx USB Dedicated Charging Port Controller

### 1 Features

- Supports USB DCP Shorting D+ Line to D– Line per USB Battery Charging Specification, Revision 1.2 (BC1.2)
- Supports Shorted Mode (Shorting D+ Line to D– Line) per Chinese Telecommunication Industry Standard YD/T 1591-2009
- Supports USB DCP Applying 2.7 V on D+ Line and 2 V on D– line (or USB DCP Applying 2 V on D+ Line and 2.7 V on D– Line) (TPS2513, TPS2514)
- Supports USB DCP Applying 2.7 V on D+ Line and 2.7 V on D– Line (TPS2513A, TPS2514A)
- Supports USB DCP Applying 1.2 V on D+ and D– Lines
- Automatically Switch D+ and D– Lines Connections for an Attached Device
- Dual USB Port Controller (TPS2513, TPS2513A)
- Single USB Port Controller (TPS2514, TPS2514A)
- Operating Range: 4.5 V to 5.5 V
- Available in SOT23-6 Package

### 2 Applications

- Vehicle USB Power Chargers
- AC-DC Adapters with USB Ports
- Other USB Chargers

### 3 Description

The TPS251xx devices are USB dedicated charging port (DCP) controllers. An auto-detect feature monitors USB data line voltage, and automatically provides the correct electrical signatures on the data lines to charge compliant devices among the following dedicated charging schemes:

1. Divider 1 DCP, required to apply 2 V and 2.7 V on the D+ and D– Lines respectively (TPS2513, TPS2514)
2. Divider 2 DCP, required to apply 2.7 V and 2 V on the D+ and D– Lines respectively (TPS2513, TPS2514)
3. Divider 3 DCP, required to apply 2.7 V and 2.7 V on the D+ and D– Lines respectively (TPS2513A, TPS2514A)
4. BC1.2 DCP, required to short the D+ Line to the D– Line
5. Chinese Telecom Standard YD/T 1591-2009 Shorted Mode, required to short the D+ Line to the D– Line
6. 1.2 V on both D+ and D– Lines

#### Device Information<sup>(1)</sup>

PART NUMBER	PACKAGE	BODY SIZE (NOM)
TPS2513, TPS2514	SOT-23 (6)	2.90 mm x 1.60 mm

(1) For all available packages, see the orderable addendum at the end of the datasheet.

#### Simplified Schematic

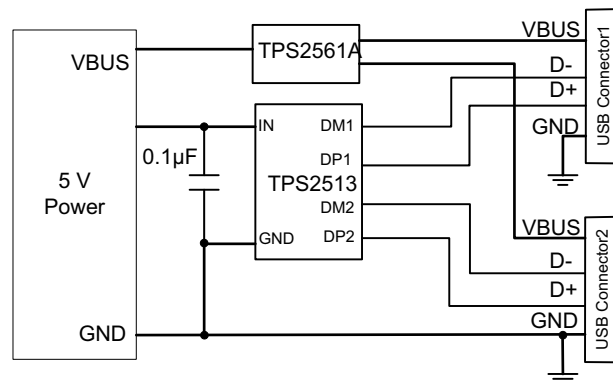

Copyright © 2016, Texas Instruments Incorporated



## Table of Contents

<b>1 Features</b> .....	<b>1</b>	8.4 Device Functional Modes .....	<b>12</b>
<b>2 Applications</b> .....	<b>1</b>	<b>9 Applications and Implementation</b> .....	<b>13</b>
<b>3 Description</b> .....	<b>1</b>	9.1 Application Information .....	<b>13</b>
<b>4 Revision History</b> .....	<b>2</b>	9.2 Typical Applications .....	<b>13</b>
<b>5 Device Options</b> .....	<b>3</b>	<b>10 Power Supply Recommendations</b> .....	<b>15</b>
<b>6 Pin Configuration and Functions</b> .....	<b>4</b>	<b>11 Layout</b> .....	<b>15</b>
<b>7 Specifications</b> .....	<b>5</b>	11.1 Layout Guidelines .....	<b>15</b>
7.1 Absolute Maximum Ratings .....	<b>5</b>	11.2 Layout Example .....	<b>15</b>
7.2 ESD Ratings .....	<b>5</b>	<b>12 Device and Documentation Support</b> .....	<b>16</b>
7.3 Recommended Operating Conditions .....	<b>5</b>	12.1 Related Links .....	<b>16</b>
7.4 Thermal Information .....	<b>5</b>	12.2 Receiving Notification of Documentation Updates .....	<b>16</b>
7.5 Electrical Characteristics .....	<b>6</b>	12.3 Community Resources .....	<b>16</b>
7.6 Typical Characteristics .....	<b>7</b>	12.4 Trademarks .....	<b>16</b>
<b>8 Detailed Description</b> .....	<b>9</b>	12.5 Electrostatic Discharge Caution .....	<b>16</b>
8.1 Overview .....	<b>9</b>	12.6 Glossary .....	<b>16</b>
8.2 Functional Block Diagrams .....	<b>10</b>	<b>13 Mechanical, Packaging, and Orderable Information</b> .....	<b>16</b>
8.3 Feature Description .....	<b>11</b>		

## 4 Revision History

NOTE: Page numbers for previous revisions may differ from page numbers in the current version.

<b>Changes from Revision B (September 2013) to Revision C</b>	<b>Page</b>
• Added ESD Rating table, Feature Description section, Device Functional Modes, Application and Implementation section, Power Supply Recommendations section, Layout section, Device and Documentation Support section, and Mechanical, Packaging, and Orderable Information section .....	<b>1</b>
• Changed DM1 output voltage parameter symbol in Electrical Characteristics From: $V_{DM1\_2V}$ To: $V_{DM1\_2.7V}$ .....	<b>6</b>
• Changed DM2 output voltage parameter symbol in Electrical Characteristics From: $V_{DM2\_2V}$ To: $V_{DM2\_2.7V}$ .....	<b>6</b>

<b>Changes from Revision A (May 2013) to Revision B</b>	<b>Page</b>
• Added TPS2513A and TPS2514A devices throughout data sheet .....	<b>1</b>
• Changed Feature list to specify TPS251, TPS2513A, TPS2514, and TPS2514A devices .....	<b>1</b>
• Changed list of charging scheme items in Description .....	<b>1</b>
• Changed Divider Mode section of the ELECTRICAL CHARACTERISTICS table to show values for the different devices .	<b>6</b>
• Changed Functional Block Diagram for TPS2513, TPS2513A .....	<b>10</b>
• Changed Functional Block Diagram for TPS2514, TPS2514A .....	<b>10</b>
• Changed section title From: Divider 1 (DCP Applying 2 V on D+ Line and 2.7 V on D– Line) or Divider 2 (DCP Applying 2.7 V on D+ Line and 2 V on D– Line) To: Divider DCP .....	<b>11</b>
• Changed text in the Divider DCP paragraph .....	<b>11</b>
• Added Divider 3 DCP image .....	<b>11</b>
• Changed the DCP Auto-Detect section .....	<b>12</b>

<b>Changes from Original (May 2013) to Revision A</b>	<b>Page</b>
• Changed the device From: Product Preview To: Production .....	<b>1</b>

## 5 Device Options

DEVICE	NUMBER OF CONTROLLER	CHARGING SCHEMES (DCP_AUTO)			1.2-V MODE (D+/D- SHORTED AND BIAS TO 1.2 V)	BC1.2 AND YD/T 1591-2009 MODE (D+/D- SHORTED)
		DIVIDER 1 (D+/D- = 2 V/2.7 V)	DIVIDER 2 (D+/D- = 2 V/2.7 V)	DIVIDER 3 (D+/D- = 2 V/2.7 V)		
TPS2513	Dual	Yes <sup>(1)</sup>	Yes	No	Yes	Yes
TPS2514	Single	Yes <sup>(1)</sup>	Yes	No		
TPS2513A	Dual	No	No	Yes		
TPS2514A	Single	No	No	Yes		

(1) See [Figure 16](#)

## 6 Pin Configuration and Functions

**TPS2513x DBV Package  
6-Pin SOT-23  
Top View**

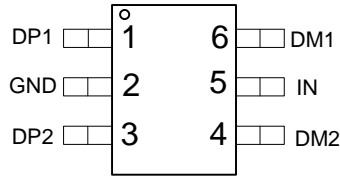

**Pin Functions: TPS2513x**

PIN		TYPE <sup>(1)</sup>	DESCRIPTION
NO.	NAME		
1	DP1	I/O	Connected to the D+ or D– line of USB connector, provide the correct voltage with attached portable equipment for DCP detection.
2	GND	G	Ground connection
3	DP2	I/O	Connected to the D+ or D– line of USB connector, provide the correct voltage with attached portable equipment for DCP detection.
4	DM2	I/O	Connected to the D+ or D– line of USB connector, provide the correct voltage with attached portable equipment for DCP detection.
5	IN	P	Power supply. Connect a ceramic capacitor with a value of 0.1- $\mu$ F or greater from the IN pin to GND as close to the device as possible.
6	DM1	I/O	Connected to the D+ or D– line of USB connector, provide the correct voltage with attached portable equipment for DCP detection.

(1) G = Ground, I = Input, O = Output, P = Power

**TPS2514x DBV Package  
6-Pin SOT-23  
Top View**

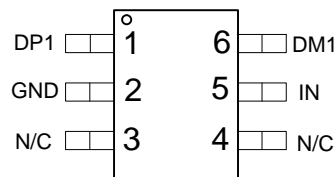

**Pin Functions: TPS2514x**

PIN		TYPE <sup>(1)</sup>	DESCRIPTION
NO.	NAME		
1	DP1	I/O	Connected to the D+ or D– line of USB connector, provide the correct voltage with attached portable equipment for DCP detection.
2	GND	G	Ground connection
3	N/C	—	No connect pin. Can be grounded or left floating.
4	N/C	—	No connect pin. Can be grounded or left floating.
5	IN	P	Power supply. Connect a ceramic capacitor with a value of 0.1- $\mu$ F or greater from the IN pin to GND as close to the device as possible.
6	DM1	I/O	Connected to the D+ or D– line of USB connector, provide the correct voltage with attached portable equipment for DCP detection.

(1) G = Ground, I = Input, O = Output, P = Power

## 7 Specifications

### 7.1 Absolute Maximum Ratings

over operating free-air temperature range (unless otherwise noted)<sup>(1)</sup>

		MIN	MAX	UNIT
Voltage	IN	-0.3	7	V
	DP1, DP2 output voltage, DM1, DM2 output voltage	-0.3	5.8	
	DP1, DP2 input voltage, DM1, DM2 input voltage	-0.3	5.8	
Continuous output sink current (DP1, DP2 input current, DM1, DM2 input current)			35	mA
Continuous output source current (DP1, DP2 output current, DM1, DM2 output current)			35	mA
Operating junction temperature, T <sub>J</sub>		-40	125	°C
Storage temperature, T <sub>stg</sub>		-65	150	°C

- (1) Stresses beyond those listed under *Absolute Maximum Ratings* may cause permanent damage to the device. These are stress ratings only, which do not imply functional operation of the device at these or any other conditions beyond those indicated under *Recommended Operating Conditions*. Exposure to absolute-maximum-rated conditions for extended periods may affect device reliability.

### 7.2 ESD Ratings

		VALUE	UNIT
V <sub>(ESD)</sub> Electrostatic discharge	Human-body model (HBM), per ANSI/ESDA/JEDEC JS-001 <sup>(1)</sup>	Pin 5	±2000
		Pins 1, 3, 4, 6	±6000
	Charged-device model (CDM), per JEDEC specification JESD22-C101 <sup>(2)</sup>		±500

- (1) JEDEC document JEP155 states that 500-V HBM allows safe manufacturing with a standard ESD control process.  
 (2) JEDEC document JEP157 states that 250-V CDM allows safe manufacturing with a standard ESD control process.

### 7.3 Recommended Operating Conditions

Voltages are referenced to GND (unless otherwise noted), positive current are into pins.

		MIN	MAX	UNIT
V <sub>IN</sub>	Input voltage of IN	4.5	5.5	V
V <sub>DP1</sub>	DP1 data line input voltage	0	5.5	V
V <sub>DM1</sub>	DM1 data line input voltage	0	5.5	V
I <sub>DP1</sub>	Continuous sink or source current		±10	mA
I <sub>DM1</sub>	Continuous sink or source current		±10	mA
V <sub>DP2</sub>	DP2 data line input voltage	0	5.5	V
V <sub>DM2</sub>	DM2 data line input voltage	0	5.5	V
I <sub>DP2</sub>	Continuous sink or source current		±10	mA
I <sub>DM2</sub>	Continuous sink or source current		±10	mA
T <sub>J</sub>	Operating junction temperature	-40	125	°C

### 7.4 Thermal Information

THERMAL METRIC <sup>(1)</sup>		TPS2513x, TPS2514x	UNIT
		DBV (SOT-23)	
		6 PINS	
R <sub>θJA</sub>	Junction-to-ambient thermal resistance	179.9	°C/W
R <sub>θJC(top)</sub>	Junction-to-case (top) thermal resistance	117.5	°C/W
R <sub>θJB</sub>	Junction-to-board thermal resistance	41.9	°C/W
Ψ <sub>JT</sub>	Junction-to-top characterization parameter	17.2	°C/W
Ψ <sub>JB</sub>	Junction-to-board characterization parameter	41.5	°C/W
R <sub>θJC(bot)</sub>	Junction-to-case (bottom) thermal resistance	—	°C/W

- (1) For more information about traditional and new thermal metrics, see the *IC Package Thermal Metrics* application report.

## 7.5 Electrical Characteristics

Conditions are  $-40^{\circ}\text{C} \leq (T_J = T_A) \leq 125^{\circ}\text{C}$  and  $4.5\text{ V} \leq V_{IN} \leq 5.5\text{ V}$ . Positive current are into pins. Typical values are at  $25^{\circ}\text{C}$ . All voltages are with respect to GND (unless otherwise noted).

PARAMETER		TEST CONDITIONS	MIN	TYP	MAX	UNIT
<b>UNDERVOLTAGE LOCKOUT</b>						
$V_{UVLO}$	IN rising UVLO threshold voltage		3.9	4.1	4.3	V
	Hysteresis <sup>(1)</sup>			100		mV
<b>SUPPLY CURRENT</b>						
$I_{IN}$	IN supply current	$4.5\text{ V} \leq V_{IN} \leq 5.5\text{ V}$		155	200	$\mu\text{A}$
<b>BC 1.2 DCP MODE (SHORT MODE)</b>						
$R_{DPM\_SHORT1}$	DP1 and DM1 shorting resistance	$V_{DP1} = 0.8\text{ V}, I_{DM1} = 1\text{ mA}$		157	200	$\Omega$
$R_{DCHG\_SHORT1}$	Resistance between DP1/DM1 and GND	$V_{DP1} = 0.8\text{ V}$	350	656	1150	k $\Omega$
$V_{DPL\_TH\_DETACH1}$	Voltage threshold on DP1 (under which the device goes back to divider mode)		310	330	350	mV
$V_{DPL\_TH\_DETACH\_HYS1}$	Hysteresis <sup>(1)</sup>			50		mV
$R_{DPM\_SHORT2}$	DP2 and DM2 shorting resistance	$V_{DP2} = 0.8\text{ V}, I_{DM2} = 1\text{ mA}$		157	200	$\Omega$
$R_{DCHG\_SHORT2}$	Resistance between DP2/DM2 and GND	$V_{DP2} = 0.8\text{ V}$	350	656	1150	k $\Omega$
$V_{DPL\_TH\_DETACH2}$	Voltage threshold on DP2 (under which the device goes back to divider mode)		310	330	350	mV
$V_{DPL\_TH\_DETACH\_HYS2}$	Hysteresis <sup>(1)</sup>			50		mV
<b>DIVIDER MODE (TPS2513, TPS2514)</b>						
$V_{DP1\_2.7V}$	DP1 output voltage	$V_{IN} = 5\text{ V}$	2.57	2.7	2.84	V
$V_{DM1\_2V}$	DM1 output voltage	$V_{IN} = 5\text{ V}$	1.9	2	2.1	V
$R_{DP1\_PAD1}$	DP1 output impedance	$I_{DP1} = -5\ \mu\text{A}$	24	30	36	k $\Omega$
$R_{DM1\_PAD1}$	DM1 output impedance	$I_{DM1} = -5\ \mu\text{A}$	24	30	36	k $\Omega$
$V_{DP2\_2.7V}$	DP2 output voltage	$V_{IN} = 5\text{ V}$	2.57	2.7	2.84	V
$V_{DM2\_2V}$	DM2 output voltage	$V_{IN} = 5\text{ V}$	1.9	2	2.1	V
$R_{DP2\_PAD1}$	DP2 output impedance	$I_{DP2} = -5\ \mu\text{A}$	24	30	36	k $\Omega$
$R_{DM2\_PAD1}$	DM2 output impedance	$I_{DM2} = -5\ \mu\text{A}$	24	30	36	k $\Omega$
<b>DIVIDER MODE (TPS2513A, TPS2514A)</b>						
$V_{DP1\_2.7V}$	DP1 output voltage	$V_{IN} = 5\text{ V}$	2.57	2.7	2.84	V
$V_{DM1\_2.7V}$	DM1 output voltage	$V_{IN} = 5\text{ V}$	2.57	2.7	2.84	V
$R_{DP1\_PAD1}$	DP1 output impedance	$I_{DP1} = -5\ \mu\text{A}$	24	30	36	k $\Omega$
$R_{DM1\_PAD1}$	DM1 output impedance	$I_{DM1} = -5\ \mu\text{A}$	24	30	36	k $\Omega$
$V_{DP2\_2.7V}$	DP2 output voltage	$V_{IN} = 5\text{ V}$	2.57	2.7	2.84	V
$V_{DM2\_2.7V}$	DM2 output voltage	$V_{IN} = 5\text{ V}$	2.57	2.7	2.84	V
$R_{DP2\_PAD1}$	DP2 output impedance	$I_{DP2} = -5\ \mu\text{A}$	24	30	36	k $\Omega$
$R_{DM2\_PAD1}$	DM2 output impedance	$I_{DM2} = -5\ \mu\text{A}$	24	30	36	k $\Omega$
<b>1.2 V / 1.2 V MODE</b>						
$V_{DP1\_1.2V}$	DP1 output voltage	$V_{IN} = 5\text{ V}$	1.12	1.2	1.28	V
$V_{DM1\_1.2V}$	DM1 output voltage	$V_{IN} = 5\text{ V}$	1.12	1.2	1.28	V
$R_{DM1\_PAD2}$	DP1 output impedance	$I_{DP1} = -5\ \mu\text{A}$	80	102	130	k $\Omega$
$R_{DP1\_PAD2}$	DM1 output impedance	$I_{DM1} = -5\ \mu\text{A}$	80	102	130	k $\Omega$
$V_{DP2\_1.2V}$	DP2 output voltage	$V_{IN} = 5\text{ V}$	1.12	1.2	1.28	V
$V_{DM2\_1.2V}$	DM2 output voltage	$V_{IN} = 5\text{ V}$	1.12	1.2	1.28	V
$R_{DP2\_PAD2}$	DP2 output impedance	$I_{DP2} = -5\ \mu\text{A}$	80	102	130	k $\Omega$
$R_{DM2\_PAD2}$	DM2 output impedance	$I_{DM2} = -5\ \mu\text{A}$	80	102	130	k $\Omega$

(1) Parameters provided for reference only, and do not constitute part of TI's published device specifications for purposes of TI's product warranty.

## 7.6 Typical Characteristics

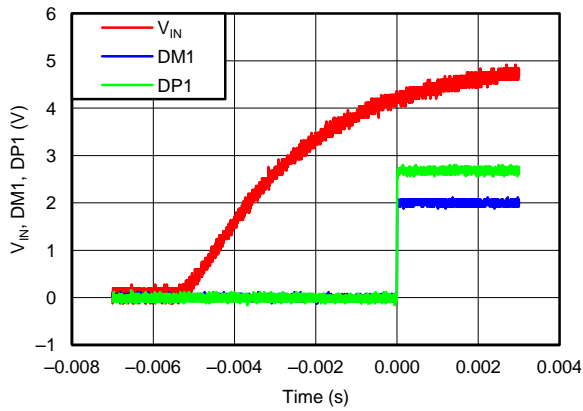

Figure 1. Power On (DM1 and DP1)

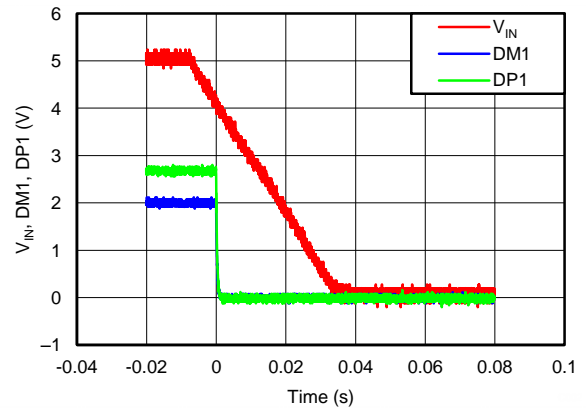

Figure 2. Power Off (DM1 and DP1)

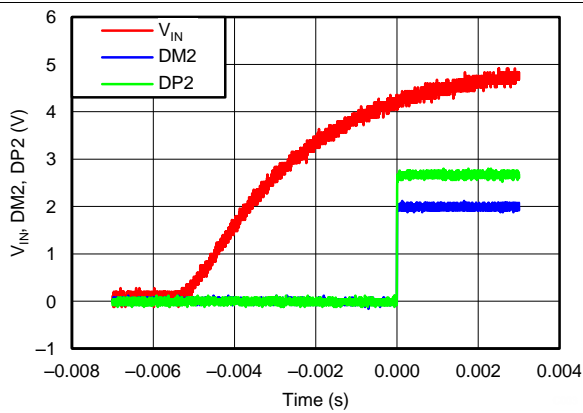

Figure 3. Power On (DM2 and DP2)

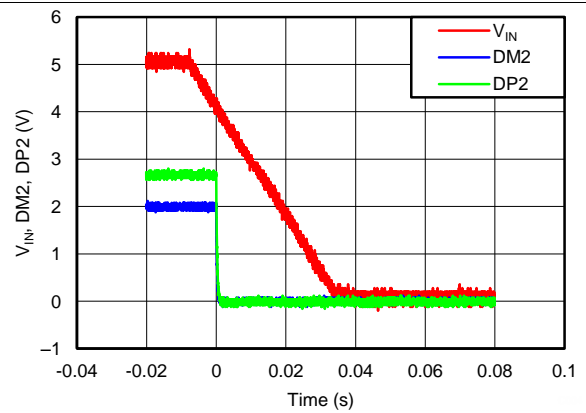

Figure 4. Power Off (DM2 and DP2)

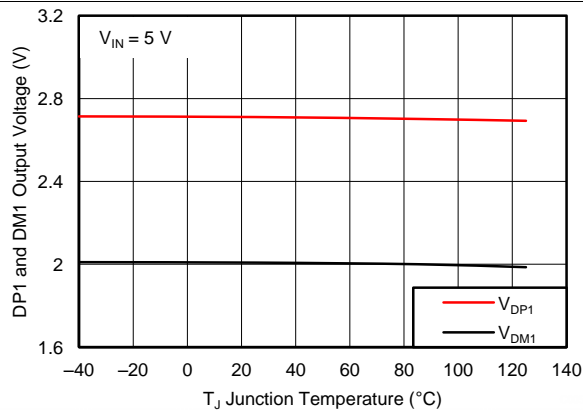

Figure 5. DP1 and DM1 Output Voltage vs Temperature

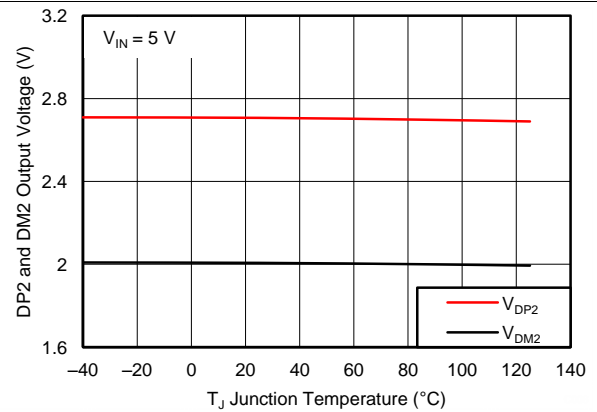
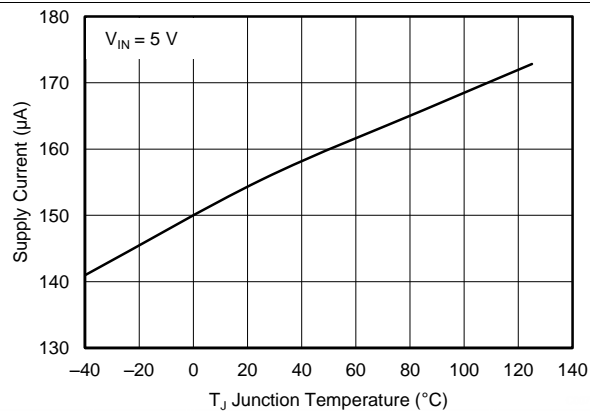

Figure 6. DP2 and DM2 Output Voltage vs Temperature

**Typical Characteristics (continued)**

**Figure 7. Supply Current vs Temperature**

## 8 Detailed Description

### 8.1 Overview

The following overview references various industry standards. TI always recommends consulting the latest standard to ensure the most recent and accurate information.

Rechargeable portable equipment requires an external power source to charge its batteries. USB ports are convenient locations for charging because of an available 5-V power source. Universally accepted standards are required to ensure host and client-side devices meet the power management requirements. Traditionally, USB host ports following the USB 2.0 Specification must provide at least 500 mA to downstream client-side devices. Because multiple USB devices can be attached to a single USB port through a bus-powered hub, it is the responsibility of the client-side device to negotiate the power allotment from the host to ensure the total current draw does not exceed 500 mA. In general, each USB device can subsequently request more current which is granted in steps of 100 mA, up 500 mA total. The host may grant or deny the request based on the available current.

Additionally, the success of the USB technology makes the micro-USB connector a popular choice for wall adapter cables. This allows a portable device to charge from both a wall adapter and USB port with only one connector.

One common difficulty has resulted from this. As USB charging has gained popularity, the 500-mA minimum defined by the USB 2.0 Specification or 900 mA defined in the USB 3.0 Specification, has become insufficient for many handsets, tablets and personal media players (PMP) which have a higher rated charging current. Wall adapters and car chargers can provide much more current than 500 mA or 900 mA to fast charge portable devices. Several new standards have been introduced defining protocol handshaking methods that allow host and client devices to acknowledge and draw additional current beyond the 500 mA (defined in the USB 2.0 Specification) or 900 mA (defined in the USB 3.0 Specification) minimum while using a single micro-USB input connector.

The devices support four of the most common protocols:

- USB Battery Charging Specification, Revision 1.2 (BC1.2)
- Chinese Telecommunications Industry Standard YD/T 1591-2009
- Divider mode
- 1.2 V on both D+ and D– lines

YD/T 1591-2009 is a subset of the BC1.2 specification supported by the vast majority of devices that implement USB charging. Divider and 1.2-V charging schemes are supported in devices from specific yet popular device makers. BC1.2 has three different port types, listed as follows.

- Standard downstream port (SDP)
- Charging downstream port (CDP)
- Dedicated charging port (DCP)

The BC1.2 Specification defines a charging port as a downstream facing USB port that provides power for charging portable equipment.

[Table 1](#) shows different port operating modes according to the BC1.2 Specification.

**Table 1. Operating Modes**

PORT TYPE	SUPPORTS USB 2.0 COMMUNICATION	MAXIMUM ALLOWABLE CURRENT DRAWN BY PORTABLE EQUIPMENT (A)
SDP (USB 2.0)	Yes	0.5
SDP (USB 3.0)	Yes	0.9
CDP	Yes	1.5
DCP	No	1.5



## 8.3 Feature Description

### 8.3.1 Dedicated Charging Port (DCP)

A dedicated charging port (DCP) is a downstream port on a device that outputs power through a USB connector but is not capable of enumerating a downstream device, which generally allows portable devices to fast charge at their maximum rated current. A USB charger is a device with a DCP, such as a wall adapter or car power adapter. A DCP is identified by the electrical characteristics of its data lines. The following DCP identification circuits are usually used to meet the handshaking detections of different portable devices.

### 8.3.2 Short the D+ Line to the D– Line

The USB BC1.2 Specification and the Chinese Telecommunications Industry Standard YD/T 1591-2009 define that the D+ and D– data lines must be shorted together with a maximum series impedance of 200  $\Omega$ . This is shown in [Figure 10](#).

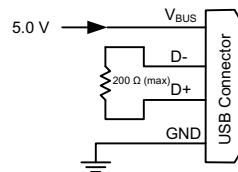

Figure 10. DCP Short Mode

### 8.3.3 Divider DCP

There are three charging schemes for divider DCP. They are named after Divider 1, Divider 2, and Divider 3 DCPs that are shown in [Figure 11](#), [Figure 12](#), and [Figure 13](#). The Divider 1 charging scheme is used for 5-W adapters, and applies 2 V to the D+ line and 2.7 V to the D– data line. The Divider 2 charging scheme is used for 10-W adapters, and applies 2.7 V on the D+ line and 2 V is applied on the D– line. The Divider 3 charging scheme is used for 12-W adapters, and applies 2.7 V on D+ and D– lines.

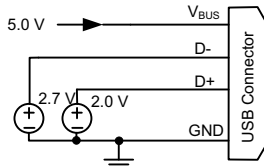

Figure 11. Divider 1 DCP

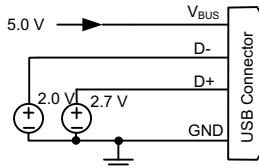

Figure 12. Divider 2 DCP

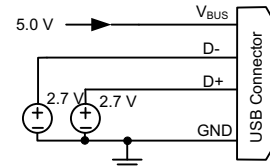

Figure 13. Divider 3 DCP

### 8.3.4 Applying 1.2 V to the D+ Line and 1.2 V to the D– Line

As shown in [Figure 14](#), some tablet USB chargers require 1.2 V on the shorted data lines of the USB connector. The maximum resistance between the D+ line and the D– line is 200  $\Omega$ .

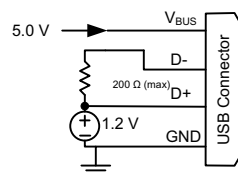

Figure 14. DCP Applying 1.2 V to the D+ Line and 1.2 V to the D– Line

The devices are USB dedicated charging port (DCP) controllers. Applications include vehicle power charger, wall adapters with USB DCP and other USB chargers. The device DCP controllers have the auto-detect feature that monitors the D+ and D– line voltages of the USB connector, providing the correct electrical signatures on the DP and DM pins for the correct detections of compliant portable devices to fast charge. These portable devices include smart phones, 5-V tablets and personal media players.

## Feature Description (continued)

### 8.3.5 DCP Auto-Detect

The devices integrate an auto-detect feature to support divider mode, short mode and 1.2 V / 1.2 V modes. If a divider device is attached, 2.7 V is applied to the DP pin and 2 V is applied to the DM pin. If a BC1.2-compliant device is attached, the TPS2513 and TPS2514 automatically switches into short mode. If a device compliant with the 1.2 V / 1.2 V charging scheme is attached, 1.2 V is applied on both the DP pin and the DM pin. The functional diagram of DCP auto-detect feature (DM1 and DP1) is shown in Figure 15. DCP auto-detect feature (DM2 and DP2 of TPS2513) has the same functional configuration. For TPS2513A and TPS2514A, the devices also have DCP auto-detect feature and the auto-detect have the same functional configuration expect for the default mode is Divider 3 (D+/D- = 2.7 V / 2.7 V).

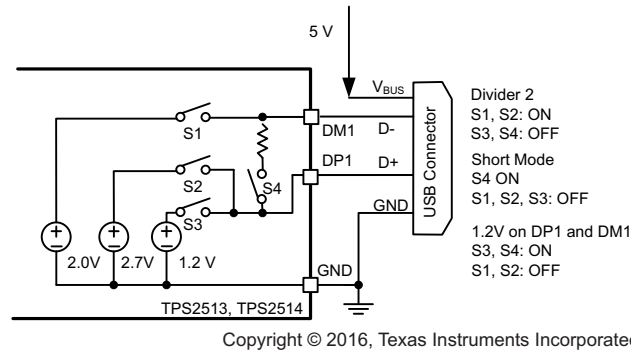

**Figure 15. TPS2513 and TPS2514 DCP Auto-Detect Functional Diagram**

### 8.3.6 Undervoltage Lockout (UVLO)

The undervoltage lockout (UVLO) circuit disables DP1, DM1, DP2 and DM2 output voltage until the input voltage reaches the UVLO turnon threshold. Built-in hysteresis prevents unwanted oscillations due to input voltage drop from large current surges.

## 8.4 Device Functional Modes

The devices operate in DCP mode and automatically monitor the voltage of the USB data lines, and provide the correct electronic signatures on the data lines to charge compliant devices.

## 9 Applications and Implementation

### NOTE

Information in the following applications sections is not part of the TI component specification, and TI does not warrant its accuracy or completeness. TI's customers are responsible for determining suitability of components for their purposes. Customers should validate and test their design implementation to confirm system functionality.

### 9.1 Application Information

The TPS251xx devices are USB dedicated charging port. The devices only provide the correct electrical signatures on the data lines of USB charger port and do not provide any power for the VBUS. Below is typical applications for USB charging ports.

### 9.2 Typical Applications

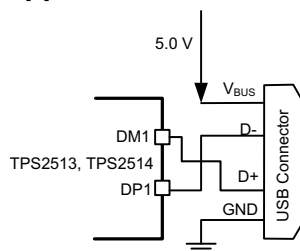

Copyright © 2016, Texas Instruments Incorporated

Figure 16. 5-W USB Charger Application

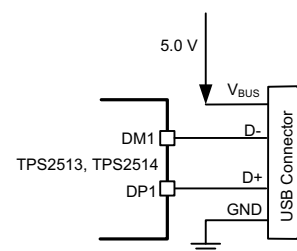

Copyright © 2016, Texas Instruments Incorporated

Figure 17. 10-W USB Charger Application

#### 9.2.1 Design Requirements

Table 2 lists the design parameters for this example.

Table 2. Design Parameters

PARAMETER	VALUE
Input voltage, $V_{(IN)}$	5 V
Output voltage, $V_{(DC)}$	5 V
Maximum continuous output current, $I_{(OUT)}$	2.5 A

#### 9.2.2 Detailed Design Procedure

##### 9.2.2.1 Divide Mode Selection of 5-W and 10-W USB Chargers

The TPS2513 and TPS2514 provide two types of connections between the DP pin and the DM pin and between the D+ data line and the D– data line of the USB connector for a 5-W USB charger and a 10-W USB charger with a single USB port. For 5-W USB charger, the DP1 pin is connected to the D– line and the DM1 pin is connected to the D+ line. This is shown in Figure 16. For 10-W USB charger, the DP1 pin is connected to the D+ line and the DM1 pin is connected to the D– line. This is shown in Figure 17. Table 3 shows different charging schemes for both 5-W and 10-W USB charger solutions. DP2 and DM2 of TPS2513 also provides this two types of connections.

Table 3. Charging Schemes for 5-W And 10-W USB Chargers

USB CHARGER TYPE	CONTAINING CHARGING SCHEMES		
5-W	Divider 1	1.2 V on both D+ and D– Lines	BC1.2 DCP
10-W	Divider 2	1.2 V on both D+ and D– Lines	BC1.2 DCP

### 9.2.3 Application Curves

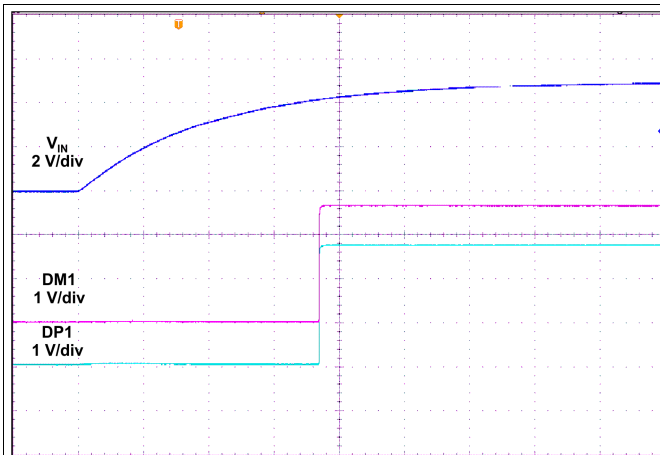

t - Time - 1 ms/div

Figure 18. POWER ON (DM1 and DP1)

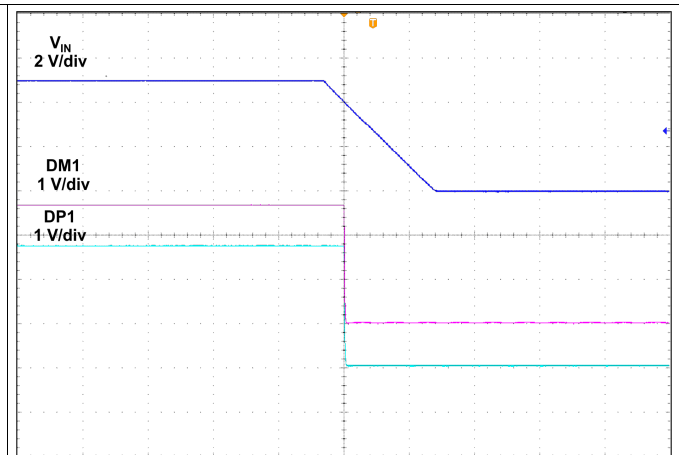

t - Time - 40 ms/div

Figure 19. POWER OFF (DM1 and DP1)

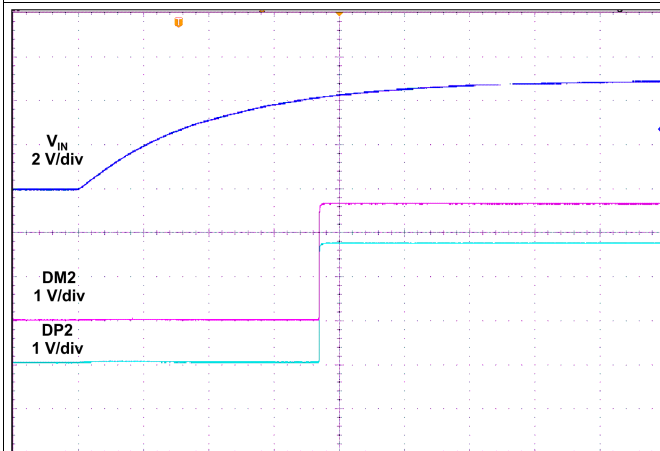

t - Time - 1 ms/div

Figure 20. POWER ON (DM2 and DP2)

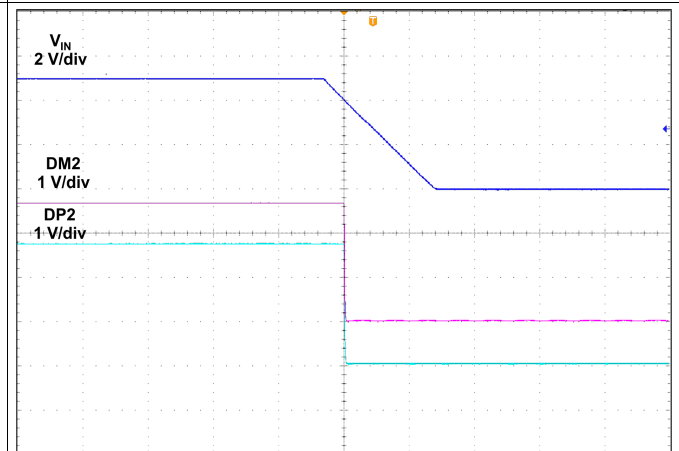

t - Time - 40 ms/div

Figure 21. POWER OFF (DM2 and DP2)

## 10 Power Supply Recommendations

The devices are designed for a supply-voltage range of  $4.5\text{ V} \leq V_{IN} \leq 5.5\text{ V}$ . If the input supply is placed more than a few inches from the device, an input ceramic bypass capacitor higher than  $0.1\text{ }\mu\text{F}$  is recommended. The undervoltage lockout (UVLO) circuit disables DP1, DM1, DP2, and DM2 output voltage until the input voltage reaches the UVLO turnon threshold.

## 11 Layout

### 11.1 Layout Guidelines

Place the devices near the USB output connector and place the  $0.1\text{-}\mu\text{F}$  bypass capacitor near the IN pin.

### 11.2 Layout Example

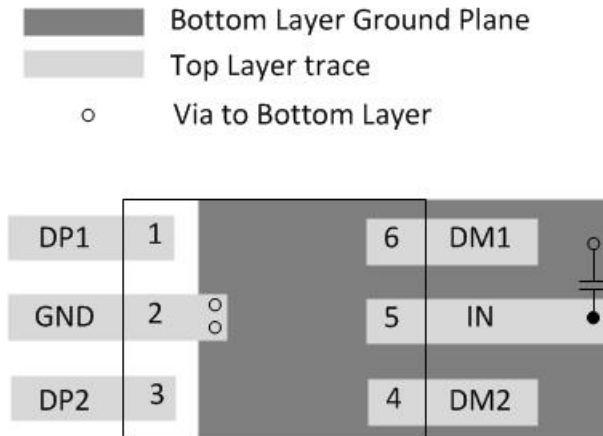

Figure 22. Layout Recommendation

## 12 Device and Documentation Support

### 12.1 Related Links

The table below lists quick access links. Categories include technical documents, support and community resources, tools and software, and quick access to sample or buy.

**Table 4. Related Links**

PARTS	PRODUCT FOLDER	SAMPLE & BUY	TECHNICAL DOCUMENTS	TOOLS & SOFTWARE	SUPPORT & COMMUNITY
TPS2513	<a href="#">Click here</a>	<a href="#">Click here</a>	<a href="#">Click here</a>	<a href="#">Click here</a>	<a href="#">Click here</a>
TPS2513A	<a href="#">Click here</a>	<a href="#">Click here</a>	<a href="#">Click here</a>	<a href="#">Click here</a>	<a href="#">Click here</a>
TPS2514	<a href="#">Click here</a>	<a href="#">Click here</a>	<a href="#">Click here</a>	<a href="#">Click here</a>	<a href="#">Click here</a>
TPS2514A	<a href="#">Click here</a>	<a href="#">Click here</a>	<a href="#">Click here</a>	<a href="#">Click here</a>	<a href="#">Click here</a>

### 12.2 Receiving Notification of Documentation Updates

To receive notification of documentation updates, navigate to the device product folder on ti.com. In the upper right corner, click on *Alert me* to register and receive a weekly digest of any product information that has changed. For change details, review the revision history included in any revised document.

### 12.3 Community Resources

The following links connect to TI community resources. Linked contents are provided "AS IS" by the respective contributors. They do not constitute TI specifications and do not necessarily reflect TI's views; see TI's [Terms of Use](#).

**TI E2E™ Online Community** *TI's Engineer-to-Engineer (E2E) Community*. Created to foster collaboration among engineers. At e2e.ti.com, you can ask questions, share knowledge, explore ideas and help solve problems with fellow engineers.

**Design Support** *TI's Design Support* Quickly find helpful E2E forums along with design support tools and contact information for technical support.

### 12.4 Trademarks

E2E is a trademark of Texas Instruments.  
All other trademarks are the property of their respective owners.

### 12.5 Electrostatic Discharge Caution



These devices have limited built-in ESD protection. The leads should be shorted together or the device placed in conductive foam during storage or handling to prevent electrostatic damage to the MOS gates.

### 12.6 Glossary

[SLYZ022](#) — *TI Glossary*.

This glossary lists and explains terms, acronyms, and definitions.

## 13 Mechanical, Packaging, and Orderable Information

The following pages include mechanical, packaging, and orderable information. This information is the most current data available for the designated devices. This data is subject to change without notice and revision of this document. For browser-based versions of this data sheet, refer to the left-hand navigation.

**PACKAGING INFORMATION**

Orderable Device	Status (1)	Package Type	Package Drawing	Pins	Package Qty	Eco Plan (2)	Lead/Ball Finish (6)	MSL Peak Temp (3)	Op Temp (°C)	Device Marking (4/5)	Samples
TPS2513ADBVR	ACTIVE	SOT-23	DBV	6	3000	Green (RoHS & no Sb/Br)	CU NIPDAU	Level-1-260C-UNLIM	-40 to 125	PB2Q	<a href="#">Samples</a>
TPS2513ADBVT	ACTIVE	SOT-23	DBV	6	250	Green (RoHS & no Sb/Br)	CU NIPDAU	Level-1-260C-UNLIM	-40 to 125	PB2Q	<a href="#">Samples</a>
TPS2513DBVR	ACTIVE	SOT-23	DBV	6	3000	Green (RoHS & no Sb/Br)	CU NIPDAU	Level-1-260C-UNLIM	-40 to 125	2513	<a href="#">Samples</a>
TPS2513DBVT	ACTIVE	SOT-23	DBV	6	250	Green (RoHS & no Sb/Br)	CU NIPDAU	Level-1-260C-UNLIM	-40 to 125	2513	<a href="#">Samples</a>
TPS2514ADBVR	ACTIVE	SOT-23	DBV	6	3000	Green (RoHS & no Sb/Br)	CU NIPDAU	Level-1-260C-UNLIM	-40 to 125	PB3Q	<a href="#">Samples</a>
TPS2514ADBVT	ACTIVE	SOT-23	DBV	6	250	Green (RoHS & no Sb/Br)	CU NIPDAU	Level-1-260C-UNLIM	-40 to 125	PB3Q	<a href="#">Samples</a>
TPS2514DBVR	ACTIVE	SOT-23	DBV	6	3000	Green (RoHS & no Sb/Br)	CU NIPDAU	Level-1-260C-UNLIM	-40 to 125	2514	<a href="#">Samples</a>
TPS2514DBVT	ACTIVE	SOT-23	DBV	6	250	Green (RoHS & no Sb/Br)	CU NIPDAU	Level-1-260C-UNLIM	-40 to 125	2514	<a href="#">Samples</a>

(1) The marketing status values are defined as follows:

**ACTIVE:** Product device recommended for new designs.

**LIFEBUY:** TI has announced that the device will be discontinued, and a lifetime-buy period is in effect.

**NRND:** Not recommended for new designs. Device is in production to support existing customers, but TI does not recommend using this part in a new design.

**PREVIEW:** Device has been announced but is not in production. Samples may or may not be available.

**OBSOLETE:** TI has discontinued the production of the device.

(2) Eco Plan - The planned eco-friendly classification: Pb-Free (RoHS), Pb-Free (RoHS Exempt), or Green (RoHS & no Sb/Br) - please check <http://www.ti.com/productcontent> for the latest availability information and additional product content details.

**TBD:** The Pb-Free/Green conversion plan has not been defined.

**Pb-Free (RoHS):** TI's terms "Lead-Free" or "Pb-Free" mean semiconductor products that are compatible with the current RoHS requirements for all 6 substances, including the requirement that lead not exceed 0.1% by weight in homogeneous materials. Where designed to be soldered at high temperatures, TI Pb-Free products are suitable for use in specified lead-free processes.

**Pb-Free (RoHS Exempt):** This component has a RoHS exemption for either 1) lead-based flip-chip solder bumps used between the die and package, or 2) lead-based die adhesive used between the die and leadframe. The component is otherwise considered Pb-Free (RoHS compatible) as defined above.

**Green (RoHS & no Sb/Br):** TI defines "Green" to mean Pb-Free (RoHS compatible), and free of Bromine (Br) and Antimony (Sb) based flame retardants (Br or Sb do not exceed 0.1% by weight in homogeneous material)

(3) MSL, Peak Temp. - The Moisture Sensitivity Level rating according to the JEDEC industry standard classifications, and peak solder temperature.

(4) There may be additional marking, which relates to the logo, the lot trace code information, or the environmental category on the device.

(5) Multiple Device Markings will be inside parentheses. Only one Device Marking contained in parentheses and separated by a "~" will appear on a device. If a line is indented then it is a continuation of the previous line and the two combined represent the entire Device Marking for that device.

(6) Lead/Ball Finish - Orderable Devices may have multiple material finish options. Finish options are separated by a vertical ruled line. Lead/Ball Finish values may wrap to two lines if the finish value exceeds the maximum column width.

**Important Information and Disclaimer:**The information provided on this page represents TI's knowledge and belief as of the date that it is provided. TI bases its knowledge and belief on information provided by third parties, and makes no representation or warranty as to the accuracy of such information. Efforts are underway to better integrate information from third parties. TI has taken and continues to take reasonable steps to provide representative and accurate information but may not have conducted destructive testing or chemical analysis on incoming materials and chemicals. TI and TI suppliers consider certain information to be proprietary, and thus CAS numbers and other limited information may not be available for release.

In no event shall TI's liability arising out of such information exceed the total purchase price of the TI part(s) at issue in this document sold by TI to Customer on an annual basis.

**OTHER QUALIFIED VERSIONS OF TPS2513A, TPS2514A :**

- Automotive: [TPS2513A-Q1](#), [TPS2514A-Q1](#)

NOTE: Qualified Version Definitions:

- Automotive - Q100 devices qualified for high-reliability automotive applications targeting zero defects

**TAPE AND REEL INFORMATION**

**QUADRANT ASSIGNMENTS FOR PIN 1 ORIENTATION IN TAPE**

\*All dimensions are nominal

Device	Package Type	Package Drawing	Pins	SPQ	Reel Diameter (mm)	Reel Width W1 (mm)	A0 (mm)	B0 (mm)	K0 (mm)	P1 (mm)	W (mm)	Pin1 Quadrant
TPS2513ADBVR	SOT-23	DBV	6	3000	178.0	9.0	3.23	3.17	1.37	4.0	8.0	Q3
TPS2513ADBVT	SOT-23	DBV	6	250	178.0	9.0	3.23	3.17	1.37	4.0	8.0	Q3
TPS2513DBVR	SOT-23	DBV	6	3000	178.0	9.0	3.23	3.17	1.37	4.0	8.0	Q3
TPS2513DBVT	SOT-23	DBV	6	250	180.0	8.4	3.2	3.2	1.4	4.0	8.0	Q3
TPS2513DBVT	SOT-23	DBV	6	250	178.0	9.0	3.23	3.17	1.37	4.0	8.0	Q3
TPS2514ADBVR	SOT-23	DBV	6	3000	178.0	9.0	3.23	3.17	1.37	4.0	8.0	Q3
TPS2514ADBVT	SOT-23	DBV	6	250	178.0	9.0	3.23	3.17	1.37	4.0	8.0	Q3
TPS2514DBVR	SOT-23	DBV	6	3000	180.0	8.4	3.2	3.2	1.4	4.0	8.0	Q3
TPS2514DBVT	SOT-23	DBV	6	250	180.0	8.4	3.2	3.2	1.4	4.0	8.0	Q3

**TAPE AND REEL BOX DIMENSIONS**

\*All dimensions are nominal

Device	Package Type	Package Drawing	Pins	SPQ	Length (mm)	Width (mm)	Height (mm)
TPS2513ADBVR	SOT-23	DBV	6	3000	180.0	180.0	18.0
TPS2513ADBVT	SOT-23	DBV	6	250	180.0	180.0	18.0
TPS2513DBVR	SOT-23	DBV	6	3000	180.0	180.0	18.0
TPS2513DBVT	SOT-23	DBV	6	250	210.0	185.0	35.0
TPS2513DBVT	SOT-23	DBV	6	250	180.0	180.0	18.0
TPS2514ADBVR	SOT-23	DBV	6	3000	180.0	180.0	18.0
TPS2514ADBVT	SOT-23	DBV	6	250	180.0	180.0	18.0
TPS2514DBVR	SOT-23	DBV	6	3000	210.0	185.0	35.0
TPS2514DBVT	SOT-23	DBV	6	250	210.0	185.0	35.0



# EXAMPLE BOARD LAYOUT

DBV0006A

SOT-23 - 1.45 mm max height

SMALL OUTLINE TRANSISTOR



LAND PATTERN EXAMPLE  
EXPOSED METAL SHOWN  
SCALE:15X



SOLDER MASK DETAILS

4214840/B 03/2018

NOTES: (continued)

- 6. Publication IPC-7351 may have alternate designs.
- 7. Solder mask tolerances between and around signal pads can vary based on board fabrication site.

# EXAMPLE STENCIL DESIGN

DBV0006A

SOT-23 - 1.45 mm max height

SMALL OUTLINE TRANSISTOR



SOLDER PASTE EXAMPLE  
BASED ON 0.125 mm THICK STENCIL  
SCALE:15X

4214840/B 03/2018

NOTES: (continued)

8. Laser cutting apertures with trapezoidal walls and rounded corners may offer better paste release. IPC-7525 may have alternate design recommendations.
9. Board assembly site may have different recommendations for stencil design.

## IMPORTANT NOTICE AND DISCLAIMER

TI PROVIDES TECHNICAL AND RELIABILITY DATA (INCLUDING DATASHEETS), DESIGN RESOURCES (INCLUDING REFERENCE DESIGNS), APPLICATION OR OTHER DESIGN ADVICE, WEB TOOLS, SAFETY INFORMATION, AND OTHER RESOURCES "AS IS" AND WITH ALL FAULTS, AND DISCLAIMS ALL WARRANTIES, EXPRESS AND IMPLIED, INCLUDING WITHOUT LIMITATION ANY IMPLIED WARRANTIES OF MERCHANTABILITY, FITNESS FOR A PARTICULAR PURPOSE OR NON-INFRINGEMENT OF THIRD PARTY INTELLECTUAL PROPERTY RIGHTS.

These resources are intended for skilled developers designing with TI products. You are solely responsible for (1) selecting the appropriate TI products for your application, (2) designing, validating and testing your application, and (3) ensuring your application meets applicable standards, and any other safety, security, or other requirements. These resources are subject to change without notice. TI grants you permission to use these resources only for development of an application that uses the TI products described in the resource. Other reproduction and display of these resources is prohibited. No license is granted to any other TI intellectual property right or to any third party intellectual property right. TI disclaims responsibility for, and you will fully indemnify TI and its representatives against, any claims, damages, costs, losses, and liabilities arising out of your use of these resources.

TI's products are provided subject to TI's Terms of Sale ([www.ti.com/legal/termsofsale.html](http://www.ti.com/legal/termsofsale.html)) or other applicable terms available either on [ti.com](http://ti.com) or provided in conjunction with such TI products. TI's provision of these resources does not expand or otherwise alter TI's applicable warranties or warranty disclaimers for TI products.

Mailing Address: Texas Instruments, Post Office Box 655303, Dallas, Texas 75265  
Copyright © 2019, Texas Instruments Incorporated

## Looking for pricing, stock, or lifecycle information?

Click below to explore more details on WIN SOURCE:

 [View TPS2513ADBVT on WIN SOURCE](#)

 [Texas Instruments](#) Information

## Optimize Your Supply Chain with WIN SOURCE Solutions

-  Global Sourcing Solution
-  Obsolete Management
-  Cost Control Management
-  Shortage Management
-  Alternative Solution
-  Excess Inventory Management