



THE DATASHEET OF DFR0208



TP4056 1A Standalone Linear Li-Ion Battery Charger with Thermal Regulation in SOP-8

DESCRIPTION

The TP4056 is a complete constant-current/constant-voltage linear charger for single cell lithium-ion batteries. Its SOP package and low external component count make the TP4056 ideally suited for portable applications. Furthermore, the TP4056 can work within USB and wall adapter.

No blocking diode is required due to the internal PMOSFET architecture and have prevent to negative Charge Current Circuit. Thermal feedback regulates the charge current to limit the die temperature during high power operation or high ambient temperature. The charge voltage is fixed at 4.2V, and the charge current can be programmed externally with a single resistor. The TP4056 automatically terminates the charge cycle when the charge current drops to 1/10th the programmed value after the final float voltage is reached.

TP4056 Other features include current monitor, under voltage lockout, automatic recharge and two status pin to indicate charge termination and the presence of an input voltage.

FEATURES

- Programmable Charge Current Up to 1000mA
- No MOSFET, Sense Resistor or Blocking Diode Required
- Complete Linear Charger in SOP-8 Package for Single Cell Lithium-Ion Batteries
- Constant-Current/Constant-Voltage
- Charges Single Cell Li-Ion Batteries Directly from USB Port
- Preset 4.2V Charge Voltage with 1.5% Accuracy
- Automatic Recharge
- two Charge Status Output Pins
- C/10 Charge Termination
- 2.9V Trickle Charge Threshold (TP4056)
- Soft-Start Limits Inrush Current
- Available Radiator in 8-Lead SOP Package, the Radiator need connect GND or impending

ABSOLUTE MAXIMUM RATINGS

- Input Supply Voltage(V_{CC}): $-0.3V \sim 8V$
- TEMP: $-0.3V \sim 10V$
- CE: $-0.3V \sim 10V$
- BAT Short-Circuit Duration: Continuous
- BAT Pin Current: 1200mA
- PROG Pin Current: 1200uA
- Maximum Junction Temperature: $145^{\circ}C$
- Operating Ambient Temperature Range: $-40^{\circ}C \sim 85^{\circ}C$
- Lead Temp.(Soldering, 10sec): $260^{\circ}C$

APPLICATIONS

- Cellular Telephones, PDAs, GPS
- Charging Docks and Cradles
- Digital Still Cameras, Portable Devices
- USB Bus-Powered Chargers,Chargers

PACKAGE/ORDER INFORMATION

SOP-8	
	ORDER PART NUMBER TP4056-42-SOP8-PP
	PART MARKING TP4056

Complete Charge Cycle (1000mAh Battery)

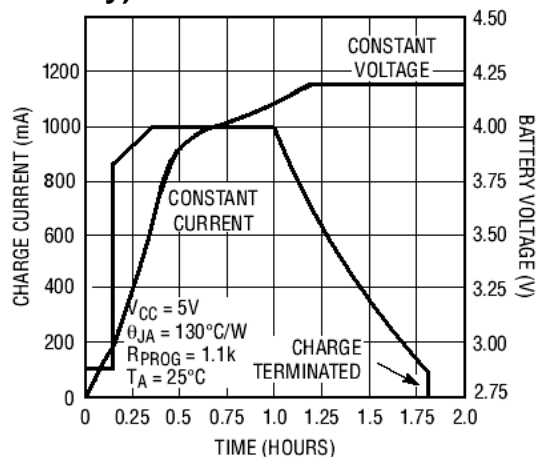

TEMP(Pin 1) :Temperature Sense Input Connecting TEMP pin to NTC thermistor's output in Lithium ion battery pack. If TEMP pin's voltage is below 45% or above 80% of supply voltage V_{IN} for more than 0.15S, this means that battery's temperature is too high or too low, charging is suspended. The temperature sense function can be disabled by grounding the TEMP pin.

PROG(Pin 2): Constant Charge Current Setting and Charge Current Monitor Pin charge current is set by connecting a resistor R_{ISET} from this pin to GND. When in precharge mode, the ISET pin's voltage is regulated to 0.2V. When in constant charge current mode, the ISET pin's voltage is regulated to 2V. In all modes during charging, the voltage on ISET pin can be used to measure the charge current as follows:

GND(Pin3): Ground Terminal

$$I_{BAT} = \frac{V_{PROG}}{R_{PROG}} \times 1200 \quad (V_{PROG}=1V)$$

Vcc(Pin 4): Positive Input Supply Voltage V_{IN} is the power supply to the internal circuit. When V_{IN} drops to within 30mv of the BAT pin voltage, TP4056 enters low power sleep mode, dropping BAT pin's current to less than 2uA.

BAT(Pin5): Battery Connection Pin. Connect the positive terminal of the battery to BAT pin. BAT pin draws less than 2uA current in chip disable mode or in sleep mode. BAT pin provides charge current to the battery and provides regulation voltage of 4.2V.

STDBY(Pin6): Open Drain Charge Status Output When the battery Charge Termination, the \overline{STDBY} pin is pulled low by an internal switch, otherwise \overline{STDBY} pin is in high impedance state.

CHRG (Pin7): Open Drain Charge Status Output When the battery is being charged, the \overline{CHRG} pin is pulled low by an internal switch, otherwise \overline{CHRG} pin is in high impedance state.

CE(Pin8): Chip Enable Input. A high input will put the device in the normal operating mode.

Pulling the CE pin to low level will put the YP4056 into disable mode. The CE pin can be driven by TTL or CMOS logic level.

ELECTRICAL CHARACTERISTICS

The ● denotes specifications which apply over the full operating temperature range, otherwise specifications are at $T_A=25^\circ\text{C}$, $V_{CC}=5V$, unless otherwise noted.

SYMBOL	PARAMETER	CONDITIONS	MIN	TYP	MAX	UNITS	
V_{CC}	Input Supply Voltage		● 4.0	5	8.0	V	
I_{CC}	Input Supply Current	Charge Mode, $R_{PROG} = 1.2k$	●	150	500	μA	
		StandbyMode(Charge Terminated)	●	55	100	μA	
		Shutdown Mode (R_{PROG} Not Connected, $V_{CC} < V_{BAT}$, or $V_{CC} < V_{UV}$)	●	55	100	μA	
V_{FLOAL}	Regulated Output (Float) Voltage	$0^\circ\text{C} \leq T_A \leq 85^\circ\text{C}$, $I_{BAT}=40\text{mA}$	4.137	4.2	4.263	V	
I_{BAT}	BAT Pin Current Text condition: $V_{BAT}=4.0V$	$R_{PROG} = 2.4k$, Current Mode	●	450	500	550	mA
		$R_{PROG} = 1.2k$, Current Mode	●	950	1000	1050	mA
		Standby Mode, $V_{BAT} = 4.2V$	●	0	-2.5	-6	μA
I_{TRIKL}	Trickle Charge Current	$V_{BAT} < V_{TRIKL}$, $R_{PROG}=1.2K$	● 120	130	140	mA	
V_{TRIKL}	Trickle Charge Threshold Voltage	$R_{PROG}=1.2K$, V_{BAT} Rising	2.8	2.9	3.0	V	
V_{TRHYS}	Trickle Charge Hysteresis Voltage	$R_{PROG}=1.2K$	60	80	100	mV	
T_{LIM}	Junction Temperature in Constant Temperature Mode			145		$^\circ\text{C}$	

indicator light state

Charge state	Red LED $\overline{\text{CHRG}}$	Green LED $\overline{\text{STDBY}}$
charging	bright	extinguish
Charge Termination	extinguish	bright
Vin too low; Temperature of battery too low or too high; no battery	extinguish	extinguish
BAT PIN Connect 10u Capacitance; No battery	Green LED bright, Red LED Coruscate T=1-4 S	

Rprog Current Setting

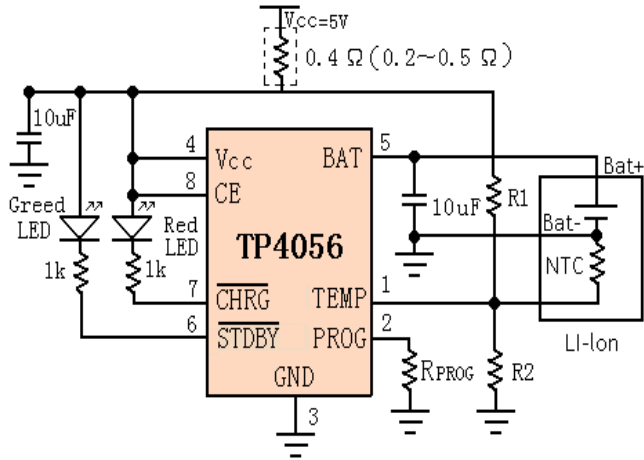

R _{PROG} (k)	I _{BAT} (mA)
10	130
5	250
4	300
3	400
2	580
1.66	690
1.5	780
1.33	900
1.2	1000

TYPICAL APPLICATIONS









Looking for pricing, stock, or lifecycle information?

Click below to explore more details on WIN SOURCE:

-  [View DFR0208 on WIN SOURCE](#)
-  [DFRobot Information](#)

Optimize Your Supply Chain with WIN SOURCE Solutions

-  Global Sourcing Solution
-  Obsolete Management
-  Cost Control Management
-  Shortage Management
-  Alternative Solution
-  Excess Inventory Management