



THE DATASHEET OF LMC6494AEM/NOPB



LMC6492 Dual/LMC6494 Quad CMOS Rail-to-Rail Input and Output Operational Amplifier

 Check for Samples: [LMC6492](#), [LMC6494](#)

FEATURES

(Typical Unless Otherwise Noted)

- Rail-to-Rail Input Common-Mode Voltage Range, Ensured Over Temperature
- Rail-to-Rail Output Swing within 20 mV of Supply Rail, 100 k Ω Load
- Operates from 5V to 15V Supply
- Excellent CMRR and PSRR 82 dB
- Ultra Low Input Current 150 fA
- High Voltage Gain ($R_L = 100\text{ k}\Omega$) 120 dB
- Low Supply Current (@ $V_S = 5\text{V}$) 500 $\mu\text{A}/\text{Amplifier}$
- Low Offset Voltage Drift 1.0 $\mu\text{V}/^\circ\text{C}$

APPLICATIONS

- Automotive Transducer Amplifier
- Pressure Sensor
- Oxygen Sensor
- Temperature Sensor
- Speed Sensor

Connection Diagram

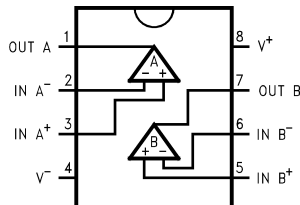

Figure 1. 8-Pin PDIP/SOIC - Top View

DESCRIPTION

The LMC6492/LMC6494 amplifiers were specifically developed for single supply applications that operate from -40°C to $+125^\circ\text{C}$. This feature is well-suited for automotive systems because of the wide temperature range. A unique design topology enables the LMC6492/LMC6494 common-mode voltage range to accommodate input signals beyond the rails. This eliminates non-linear output errors due to input signals exceeding a traditionally limited common-mode voltage range. The LMC6492/LMC6494 signal range has a high CMRR of 82 dB for excellent accuracy in non-inverting circuit configurations.

The LMC6492/LMC6494 rail-to-rail input is complemented by rail-to-rail output swing. This assures maximum dynamic signal range which is particularly important in 5V systems.

Ultra-low input current of 150 fA and 120 dB open loop gain provide high accuracy and direct interfacing with high impedance sources.

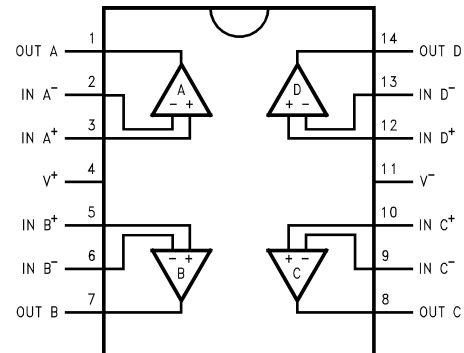

Figure 2. 14-Pin PDIP/SOIC - Top View



Please be aware that an important notice concerning availability, standard warranty, and use in critical applications of Texas Instruments semiconductor products and disclaimers thereto appears at the end of this data sheet.

All trademarks are the property of their respective owners.



These devices have limited built-in ESD protection. The leads should be shorted together or the device placed in conductive foam during storage or handling to prevent electrostatic damage to the MOS gates.

Absolute Maximum Ratings⁽¹⁾⁽²⁾

ESD Tolerance ⁽³⁾	2000V
Differential Input Voltage	±Supply Voltage
Voltage at Input/Output Pin	(V ⁺) + 0.3V, (V ⁻) - 0.3V
Supply Voltage (V ⁺ - V ⁻)	16V
Current at Input Pin	±5 mA
Current at Output Pin ⁽⁴⁾	±30 mA
Current at Power Supply Pin	40 mA
Lead Temp. (Soldering, 10 sec.)	260°C
Storage Temperature Range	-65°C to +150°C
Junction Temperature ⁽⁵⁾	150°C

- (1) Absolute Maximum Ratings indicate limits beyond which damage to the device may occur. Operating Ratings indicate conditions for which the device is intended to be functional, but specific performance is not ensured. For ensured specifications and the test conditions, see the Electrical Characteristics.
- (2) If Military/Aerospace specified devices are required, please contact the TI Sales Office/ Distributors for availability and specifications.
- (3) Human body model, 1.5 kΩ in series with 100 pF.
- (4) Applies to both single-supply and split-supply operation. Continuous short operation at elevated ambient temperature can result in exceeding the maximum allowed junction temperature at 150°C. Output currents in excess of ±30 mA over long term may adversely affect reliability.
- (5) The maximum power dissipation is a function of T_{J(max)}, θ_{JA} and T_A. The maximum allowable power dissipation at any ambient temperature is P_D = (T_{J(max)} - T_A)/θ_{JA}. All numbers apply for packages soldered directly into a PC board.

Operating Conditions⁽¹⁾

Supply Voltage		2.5V ≤ V ⁺ ≤ 15.5V
Junction Temperature Range	LMC6492AE, LMC6492BE	-40°C ≤ T _J ≤ +125°C
	LMC6494AE, LMC6494BE	-40°C ≤ T _J ≤ +125°C
Thermal Resistance (θ _{JA})	P Package, 8-Pin PDIP	108°C/W
	D Package, 8-Pin SOIC	171°C/W
	P Package, 14-Pin PDIP	78°C/W
	D Package, 14-Pin SOIC	118°C/W

- (1) Absolute Maximum Ratings indicate limits beyond which damage to the device may occur. Operating Ratings indicate conditions for which the device is intended to be functional, but specific performance is not ensured. For ensured specifications and the test conditions, see the Electrical Characteristics.

DC Electrical Characteristics

Unless otherwise specified, all limits specified for T_J = 25°C, V⁺ = 5V, V⁻ = 0V, V_{CM} = V_O = V⁺/2 and R_L > 1 MΩ. **Boldface** limits apply at the temperature extremes

Symbol	Parameter	Conditions	Typ ⁽¹⁾	LMC6492AE	LMC6492BE	Units
				LMC6494AE Limit ⁽²⁾	LMC6494BE Limit ⁽²⁾	
V _{OS}	Input Offset Voltage		0.11	3.0 3.8	6.0 6.8	mV max
TCV _{OS}	Input Offset Voltage Average Drift		1.0			µV/°C
I _B	Input Bias Current	See ⁽³⁾	0.15	200	200	pA max
I _{OS}	Input Offset Current	See ⁽³⁾	0.075	100	100	pA max
R _{IN}	Input Resistance		>10			Tera Ω

- (1) Typical Values represent the most likely parametric norm.
- (2) All limits are specified by testing or statistical analysis.
- (3) Specified limits are dictated by tester limits and not device performance. Actual performance is reflected in the typical value.

DC Electrical Characteristics (continued)

Unless otherwise specified, all limits specified for $T_J = 25^\circ\text{C}$, $V^+ = 5\text{V}$, $V^- = 0\text{V}$, $V_{\text{CM}} = V_O = V^+/2$ and $R_L > 1\text{M}\Omega$. **Boldface** limits apply at the temperature extremes

Symbol	Parameter	Conditions		Typ ⁽¹⁾	LMC6492AE LMC6494AE Limit ⁽²⁾	LMC6492BE LMC6494BE Limit ⁽²⁾	Units		
C_{IN}	Common-Mode Input Capacitance			3			pF		
CMRR	Common-Mode Rejection Ratio	$0\text{V} \leq V_{\text{CM}} \leq 15\text{V}$ $V^+ = 15\text{V}$		82	65 60	63 58	dB min		
		$0\text{V} \leq V_{\text{CM}} \leq 5\text{V}$		82	65 60	63 58			
+PSRR	Positive Power Supply Rejection Ratio	$5\text{V} \leq V^+ \leq 15\text{V}$, $V_O = 2.5\text{V}$		82	65 60	63 58	dB min		
-PSRR	Negative Power Supply Rejection Ratio	$0\text{V} \leq V^- \leq -10\text{V}$, $V_O = 2.5\text{V}$		82	65 60	63 58	dB min		
V_{CM}	Input Common-Mode Voltage Range	$V^+ = 5\text{V}$ and 15V For CMRR $\geq 50\text{ dB}$		$V^- - 0.3$	-0.25 0	-0.25 0	V max		
				$V^+ + 0.3$	$V^+ + 0.25$ V^+	$V^+ + 0.25$ V^+	V min		
A_V	Large Signal Voltage Gain	$R_L = 2\text{ k}\Omega$: ⁽⁴⁾	Sourcing	300			V/mV		
			Sinking	40			min		
V_O	Output Swing	$V^+ = 5\text{V}$ $R_L = 2\text{ k}\Omega$ to $V^+/2$		4.9	4.8 4.7	4.8 4.7	V min		
				0.1	0.18 0.24	0.18 0.24	V max		
				$V^+ = 5\text{V}$ $R_L = 600\Omega$ to $V^+/2$		4.7	4.5 4.24	4.5 4.24	V min
		0.3	0.5 0.65			0.5 0.65	V max		
		$V^+ = 15\text{V}$ $R_L = 2\text{ k}\Omega$ to $V^+/2$		14.7	14.4 14.0	14.4 14.0	V min		
				0.16	0.35 0.5	0.35 0.5	V max		
				$V^+ = 15\text{V}$ $R_L = 600\Omega$ to $V^+/2$		14.1	13.4 13.0	13.4 13.0	V min
		0.5	1.0 1.5			1.0 1.5	V max		
		I_{SC}	Output Short Circuit Current	Sourcing, $V_O = 0\text{V}$		25	16 10	16 10	mA min
				$V^+ = 5\text{V}$ Sinking, $V_O = 5\text{V}$		22	11 8	11 8	
		I_{SC}	Output Short Circuit Current	Sourcing, $V_O = 0\text{V}$		30	28 20	28 20	
				$V^+ = 15\text{V}$ Sinking, $V_O = 5\text{V}$ ⁽⁵⁾		30	30 22	30 22	

(4) $V^+ = 15\text{V}$, $V_{\text{CM}} = 7.5\text{V}$ and R_L connected to 7.5V . For Sourcing tests, $7.5\text{V} \leq V_O \leq 11.5\text{V}$. For Sinking tests, $3.5\text{V} \leq V_O \leq 7.5\text{V}$.

(5) Do not short circuit output to V^+ , when V^+ is greater than 13V or reliability will be adversely affected.

DC Electrical Characteristics (continued)

Unless otherwise specified, all limits specified for $T_J = 25^\circ\text{C}$, $V^+ = 5\text{V}$, $V^- = 0\text{V}$, $V_{\text{CM}} = V_O = V^+/2$ and $R_L > 1\text{ M}\Omega$. **Boldface** limits apply at the temperature extremes

Symbol	Parameter	Conditions	Typ ⁽¹⁾	LMC6492AE	LMC6492BE	Units
				LMC6494AE Limit ⁽²⁾	LMC6494BE Limit ⁽²⁾	
I _S	Supply Current	LMC6492	1.0	1.75	1.75	mA
		V ⁺ = +5V, V _O = V ⁺ /2		2.1	2.1	max
		LMC6492	1.3	1.95	1.95	mA
		V ⁺ = +15V, V _O = V ⁺ /2		2.3	2.3	max
		LMC6494	2.0	3.5	3.5	mA
V ⁺ = +5V, V _O = V ⁺ /2	4.2	4.2		max		
LMC6494	2.6	3.9	3.9	mA		
V ⁺ = +15V, V _O = V ⁺ /2		4.6	4.6	max		

AC Electrical Characteristics

Unless otherwise specified, all limits specified for $T_J = 25^\circ\text{C}$, $V^+ = 5\text{V}$, $V^- = 0\text{V}$, $V_{\text{CM}} = V_O = V^+/2$ and $R_L > 1\text{ M}\Omega$. **Boldface** limits apply at the temperature extremes

Symbol	Parameter	Conditions	Typ ⁽¹⁾	LMC6492AE	LMC6492BE	Units
				LMC6494AE Limit ⁽²⁾	LMC6494BE Limit ⁽²⁾	
SR	Slew Rate	See ⁽³⁾	1.3	0.7 0.5	0.7 0.5	V μ s min
GBW	Gain-Bandwidth Product	V ⁺ = 15V	1.5			MHz
ϕ_m	Phase Margin		50			Deg
G _m	Gain Margin		15			dB
	Amp-to-Amp Isolation	See ⁽⁴⁾	150			dB
e _n	Input-Referred Voltage Noise	F = 1 kHz V _{CM} = 1V	37			nV $\sqrt{\text{Hz}}$
i _n	Input-Referred Current Noise	F = 1 kHz	0.06			pA $\sqrt{\text{Hz}}$
T.H.D.	Total Harmonic Distortion	F = 1 kHz, A _V = -2 R _L = 10 k Ω , V _O = -4.1 V _{PP}	0.01			%
		F = 10 kHz, A _V = -2 R _L = 10 k Ω , V _O = 8.5 V _{PP} V ⁺ = 10V	0.01			

(1) Typical Values represent the most likely parametric norm.

(2) All limits are specified by testing or statistical analysis.

(3) V⁺ = 15V. Connected as voltage follower with 10V step input. Number specified is the slower of the positive and negative slew rates.

(4) Input referred, V⁺ = 15V and R_L = 100 k Ω connected to 7.5V. Each amp excited in turn with 1 kHz to produce V_O = 12 V_{PP}.

Typical Performance Characteristics

$V_S = +15V$, Single Supply, $T_A = 25^\circ C$ unless otherwise specified

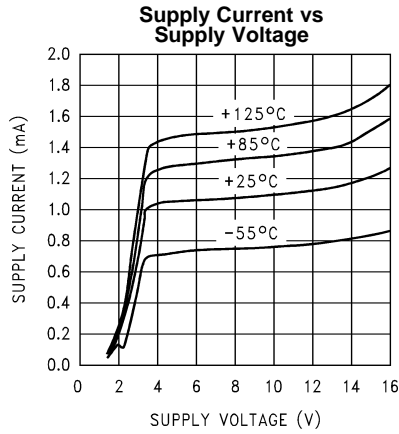

Figure 3.

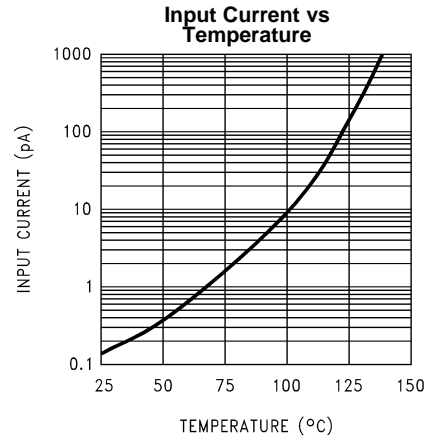

Figure 4.

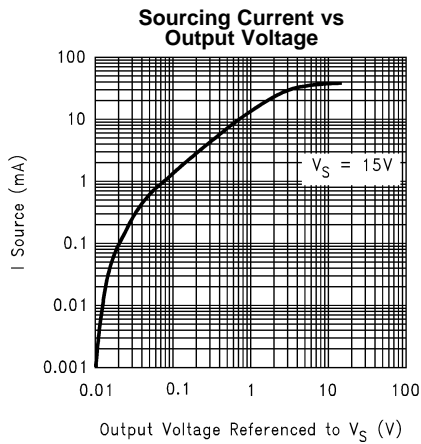

Figure 5.

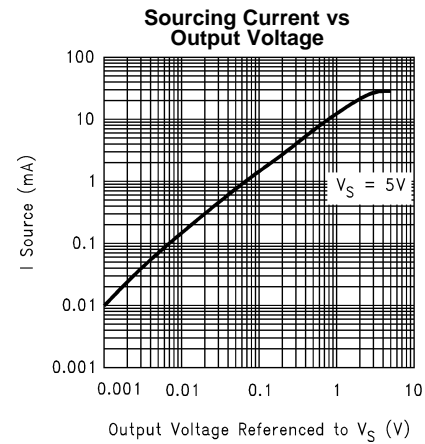

Figure 6.

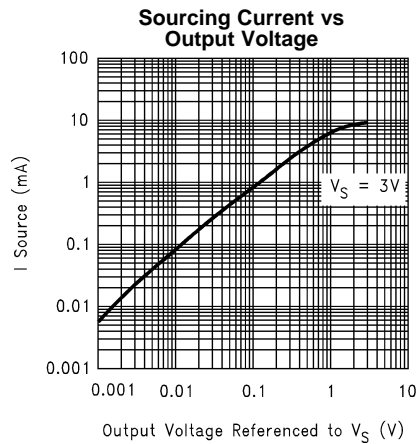

Figure 7.

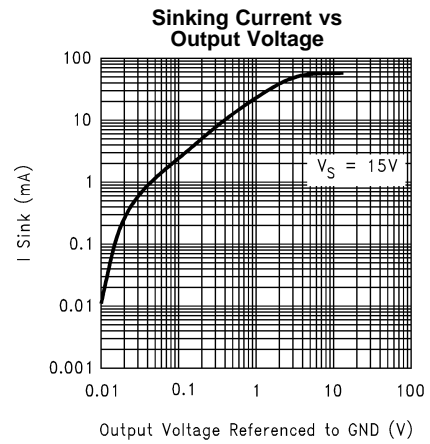

Figure 8.

Typical Performance Characteristics (continued)

$V_S = +15V$, Single Supply, $T_A = 25^\circ C$ unless otherwise specified

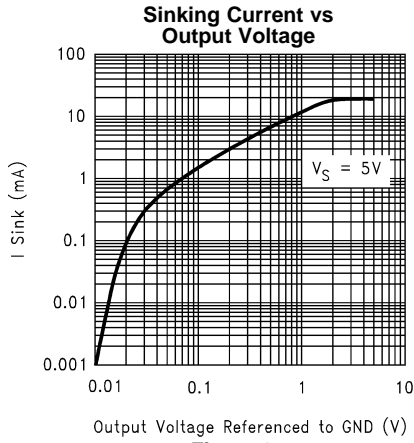

Figure 9.

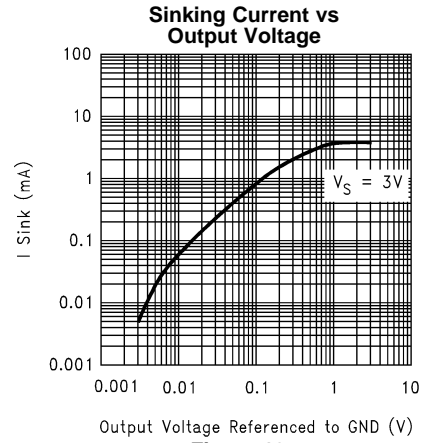

Figure 10.

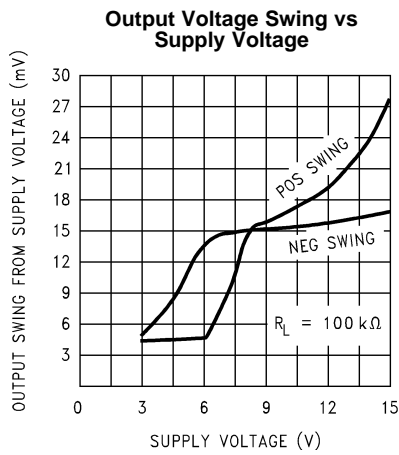

Figure 11.

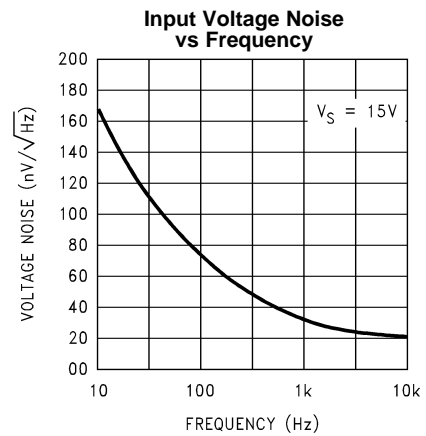

Figure 12.

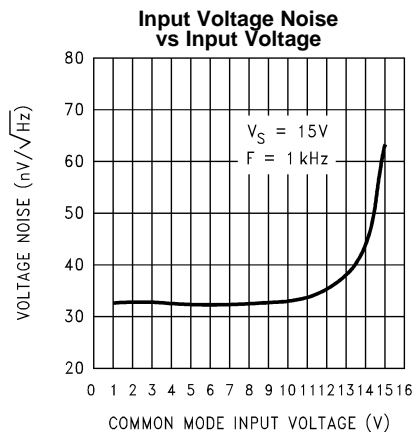

Figure 13.

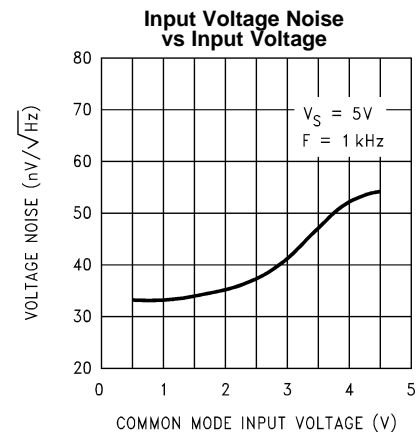

Figure 14.

Typical Performance Characteristics (continued)

$V_S = +15V$, Single Supply, $T_A = 25^\circ C$ unless otherwise specified

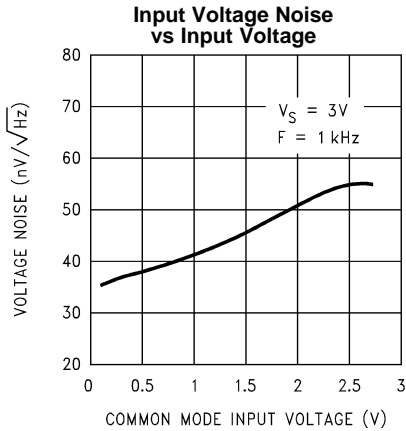

Figure 15.

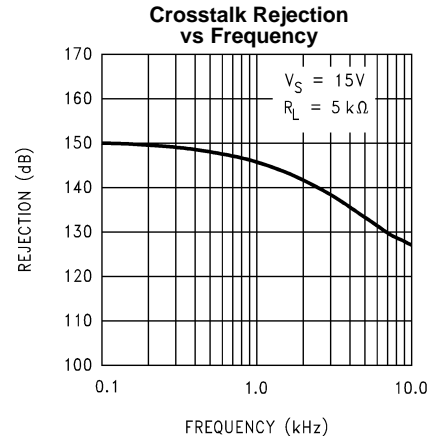

Figure 16.

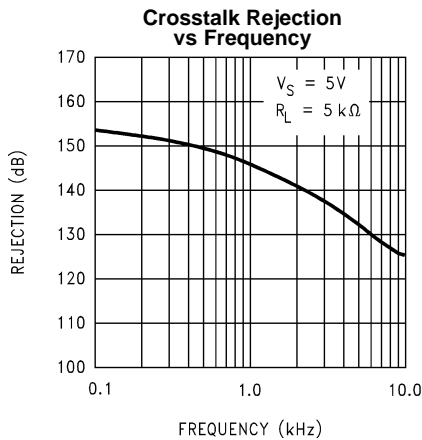

Figure 17.

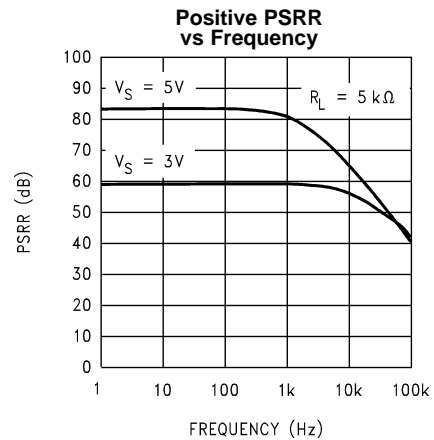

Figure 18.

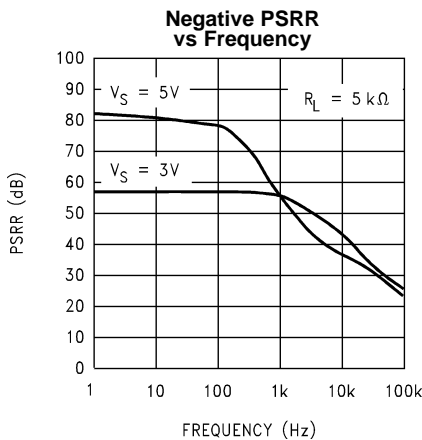

Figure 19.

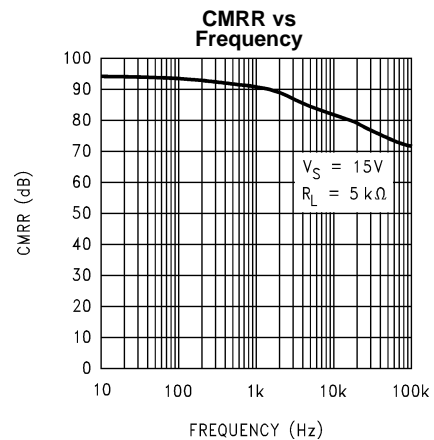

Figure 20.

Typical Performance Characteristics (continued)

$V_S = +15V$, Single Supply, $T_A = 25^\circ C$ unless otherwise specified

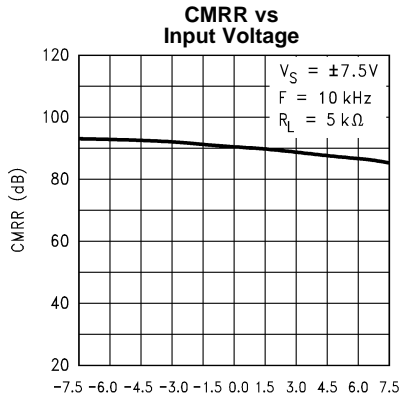

Figure 21.

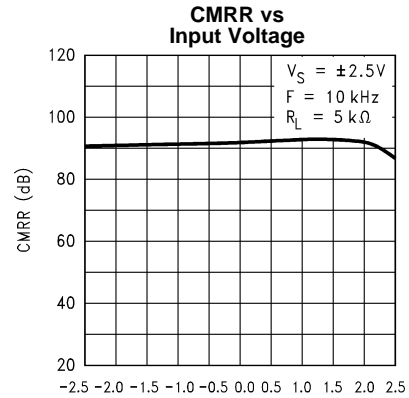

Figure 22.

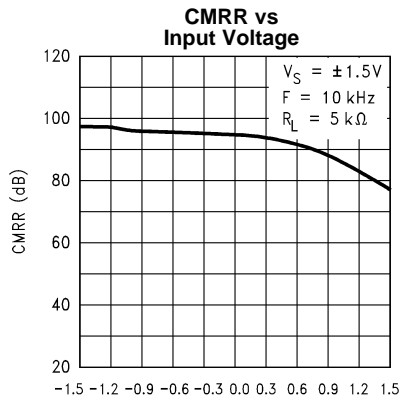

Figure 23.

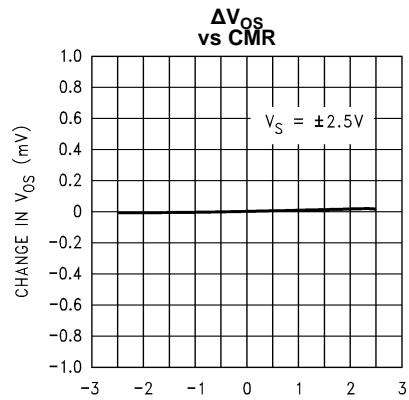

Figure 24.

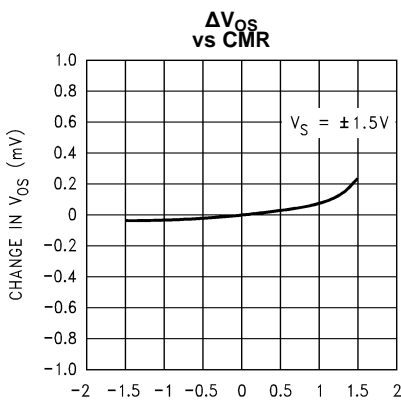

Figure 25.

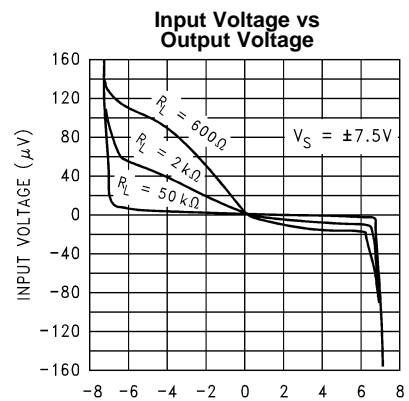

Figure 26.

Typical Performance Characteristics (continued)

$V_S = +15V$, Single Supply, $T_A = 25^\circ C$ unless otherwise specified

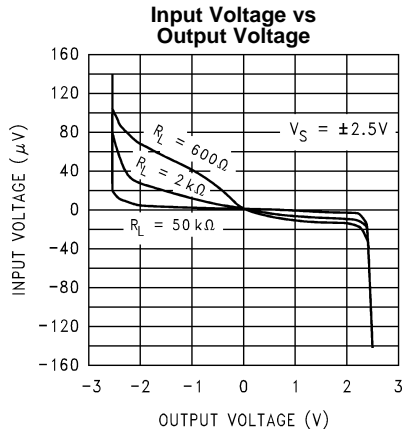

Figure 27.

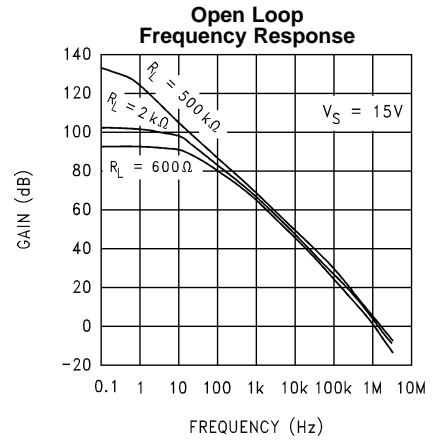

Figure 28.

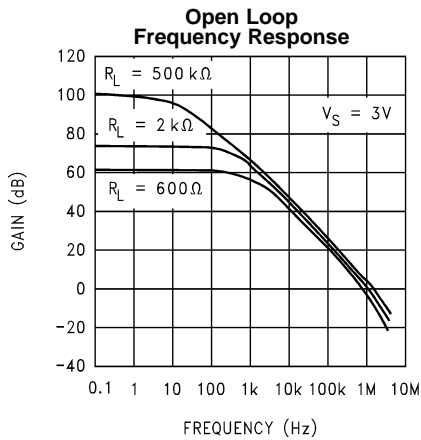

Figure 29.

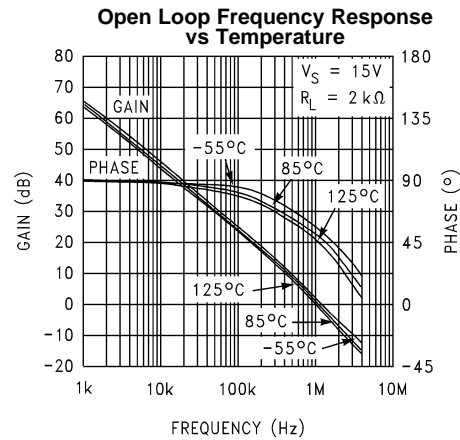

Figure 30.

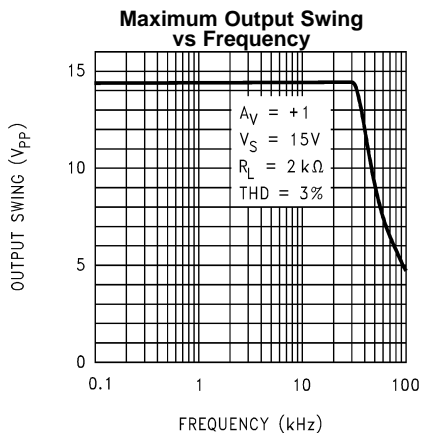

Figure 31.

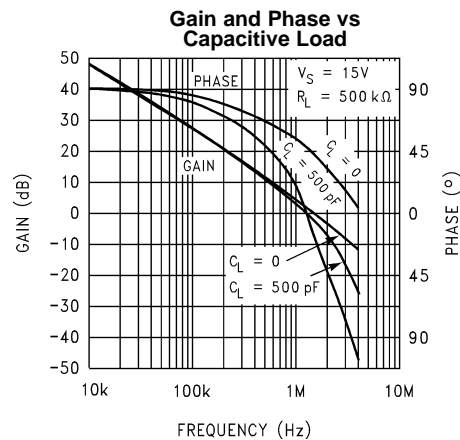

Figure 32.

Typical Performance Characteristics (continued)

$V_S = +15V$, Single Supply, $T_A = 25^\circ C$ unless otherwise specified

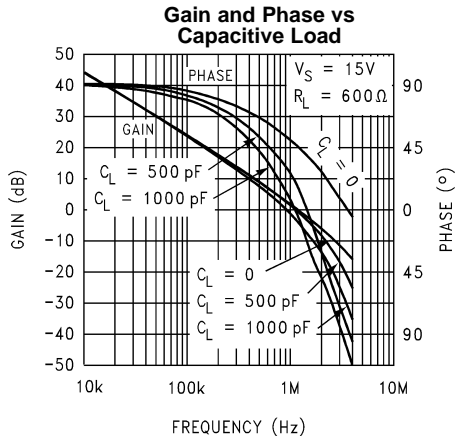

Figure 33.

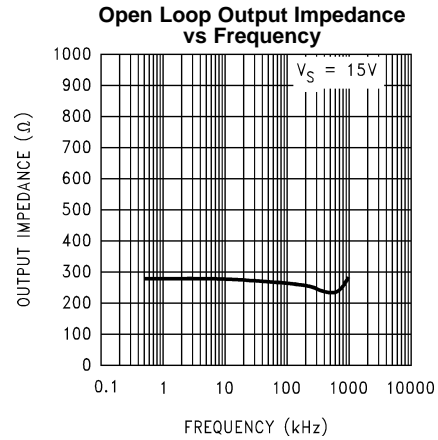

Figure 34.

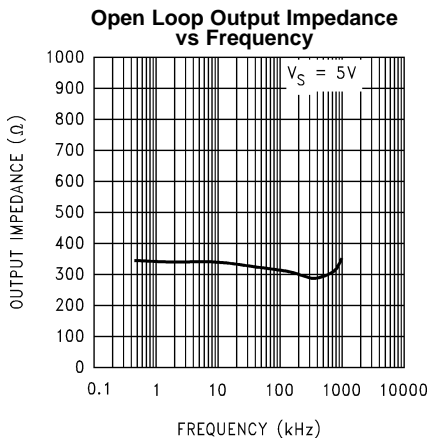

Figure 35.

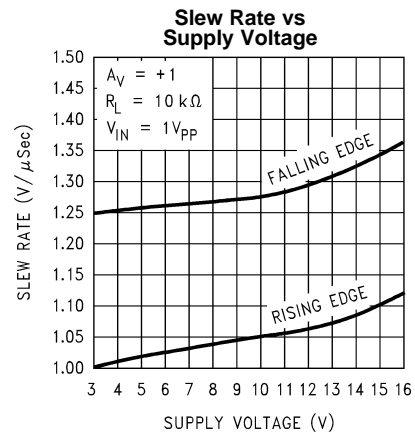

Figure 36.

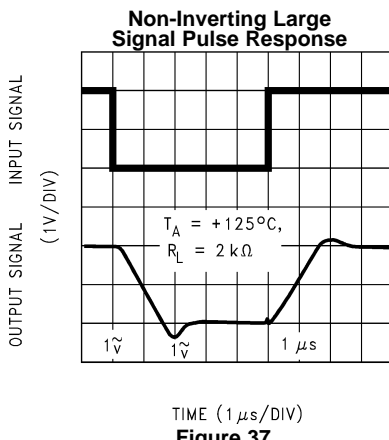

Figure 37.

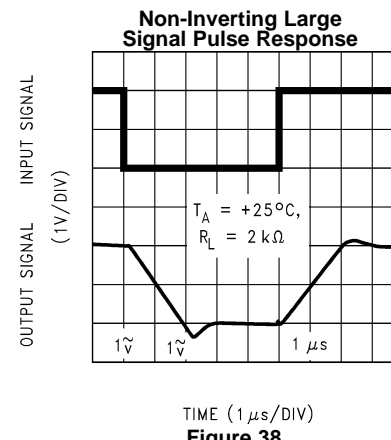
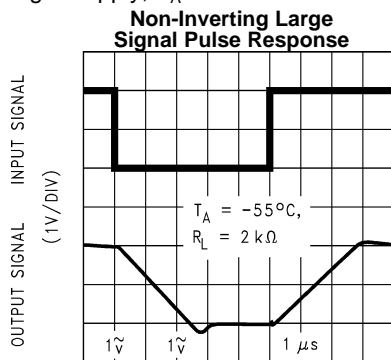

Figure 38.

Typical Performance Characteristics (continued)

$V_S = +15V$, Single Supply, $T_A = 25^\circ C$ unless otherwise specified



TIME (1 μs/DIV)
Figure 39.

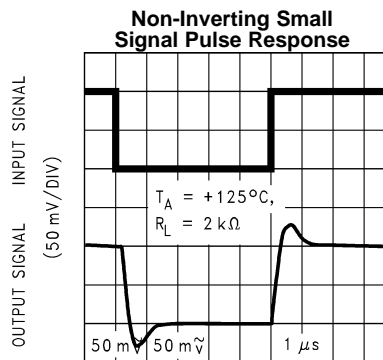

TIME (1 μs/DIV)
Figure 40.

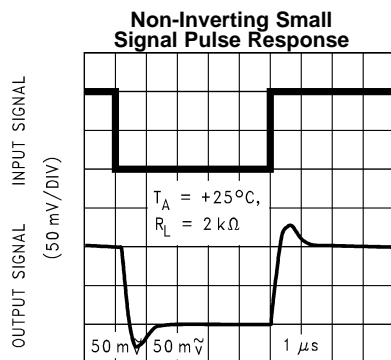

TIME (1 μs/DIV)
Figure 41.

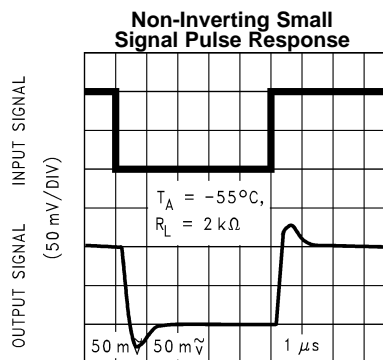

TIME (1 μs/DIV)
Figure 42.

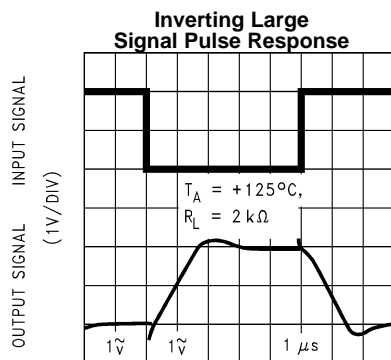

TIME (1 μs/DIV)
Figure 43.

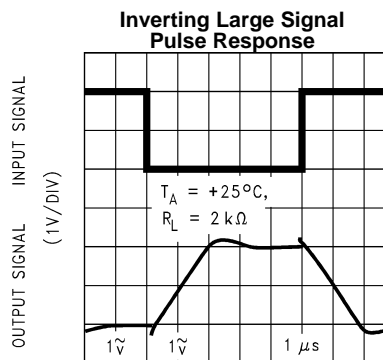

TIME (1 μs/DIV)
Figure 44.

Typical Performance Characteristics (continued)

$V_S = +15V$, Single Supply, $T_A = 25^\circ C$ unless otherwise specified

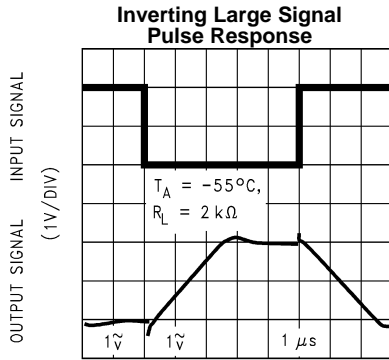

TIME (1 μs/DIV)
Figure 45.

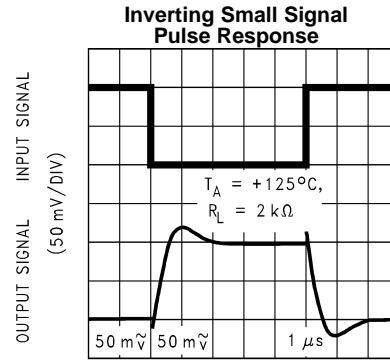

TIME (1 μs/DIV)
Figure 46.

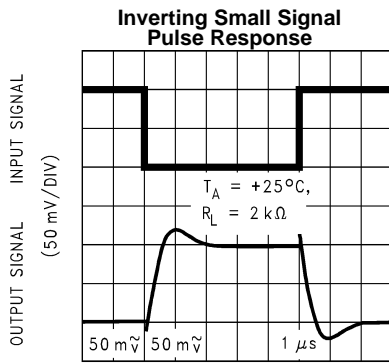

TIME (1 μs/DIV)
Figure 47.

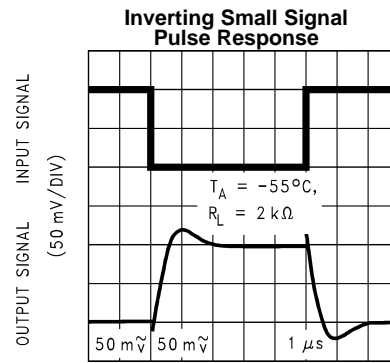

TIME (1 μs/DIV)
Figure 48.

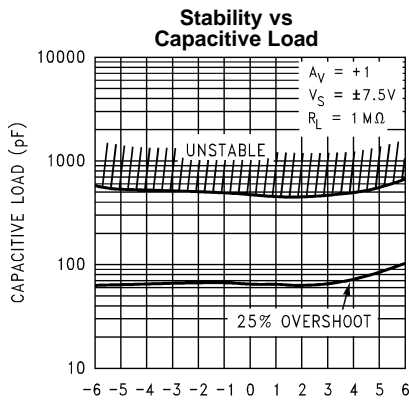

Figure 49.

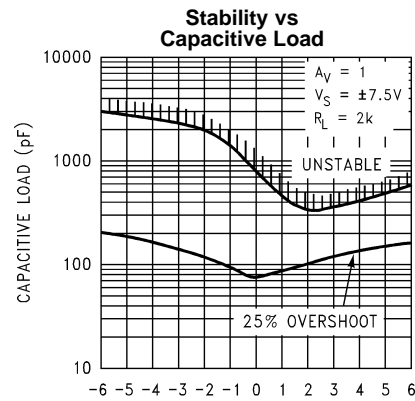

Figure 50.

Typical Performance Characteristics (continued)

V_S = +15V, Single Supply, T_A = 25°C unless otherwise specified

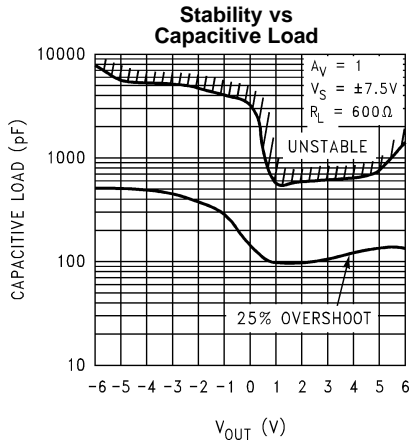

Figure 51.

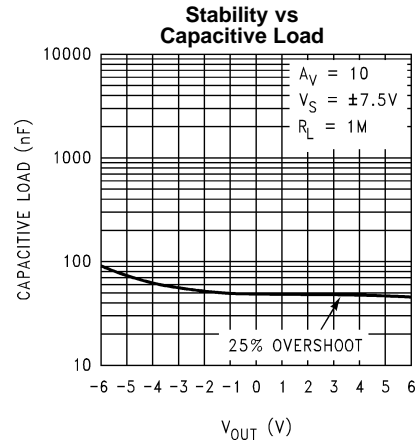

Figure 52.

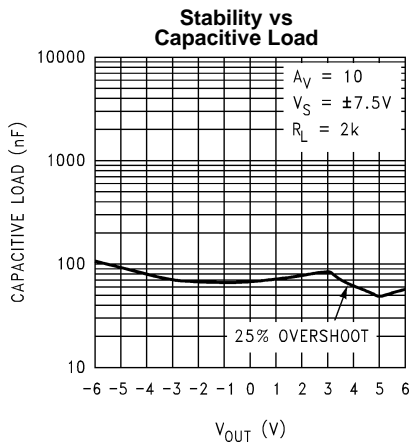

Figure 53.

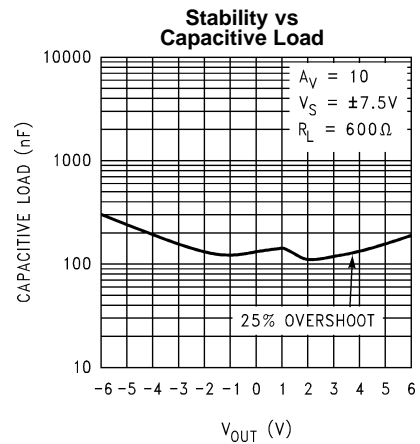

Figure 54.

APPLICATION HINTS

INPUT COMMON-MODE VOLTAGE RANGE

Unlike Bi-FET amplifier designs, the LMC6492/4 does not exhibit phase inversion when an input voltage exceeds the negative supply voltage. Figure 55 shows an input voltage exceeding both supplies with no resulting phase inversion on the output.

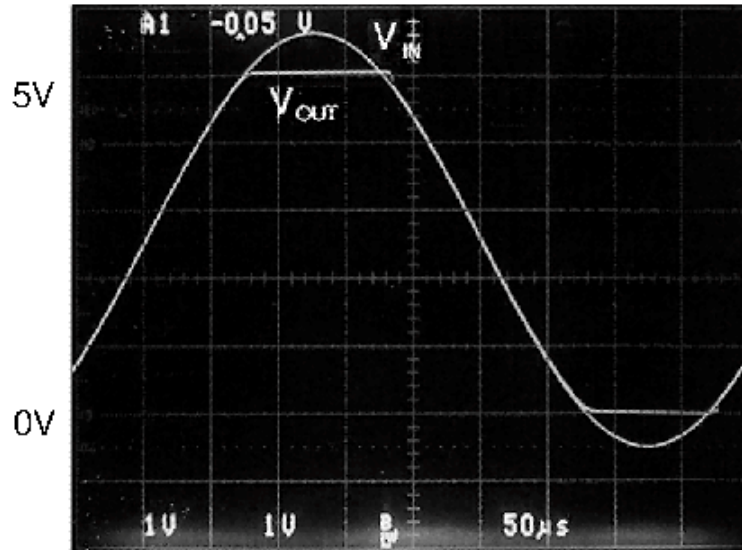

Figure 55. An Input Voltage Signal Exceeds the LMC6492/4 Power Supply Voltages with No Output Phase Inversion

The absolute maximum input voltage is 300 mV beyond either supply rail at room temperature. Voltages greatly exceeding this absolute maximum rating, as in Figure 56, can cause excessive current to flow in or out of the input pins possibly affecting reliability.

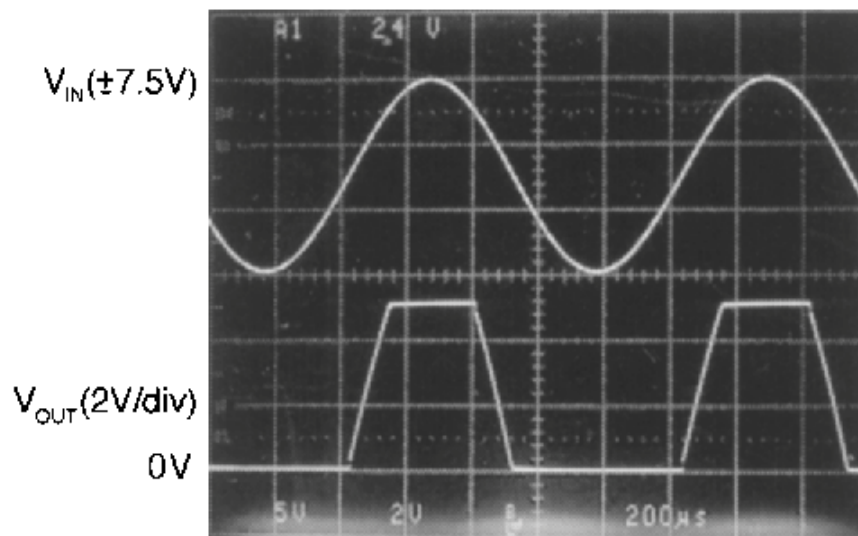

Figure 56. A ±7.5V Input Signal Greatly Exceeds the 5V Supply in Figure 57 Causing No Phase Inversion Due to R_i

Applications that exceed this rating must externally limit the maximum input current to ± 5 mA with an input resistor (R_I) as shown in Figure 57.

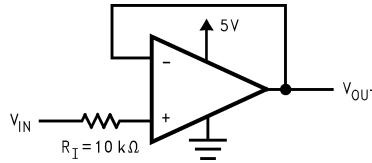

Figure 57. R_I Input Current Protection for Voltages Exceeding the Supply Voltages

RAIL-TO-RAIL OUTPUT

The approximate output resistance of the LMC6492/4 is 110 Ω sourcing and 80 Ω sinking at $V_S = 5V$. Using the calculated output resistance, maximum output voltage swing can be estimated as a function of load.

COMPENSATING FOR INPUT CAPACITANCE

It is quite common to use large values of feedback resistance for amplifiers with ultra-low input current, like the LMC6492/4.

Although the LMC6492/4 is highly stable over a wide range of operating conditions, certain precautions must be met to achieve the desired pulse response when a large feedback resistor is used. Large feedback resistors with even small values of input capacitance, due to transducers, photodiodes, and circuit board parasitics, reduce phase margins.

When high input impedances are demanded, guarding of the LMC6492/4 is suggested. Guarding input lines will not only reduce leakage, but lowers stray input capacitance as well. (See [Printed-Circuit-Board Layout for High Impedance Work](#)).

The effect of input capacitance can be compensated for by adding a capacitor, C_f , around the feedback resistors (as in Figure 55) such that:

$$\frac{1}{2\pi R_1 C_{IN}} \geq \frac{1}{2\pi R_2 C_f} \quad (1)$$

or

$$R_1 C_{IN} \leq R_2 C_f \quad (2)$$

Since it is often difficult to know the exact value of C_{IN} , C_f can be experimentally adjusted so that the desired pulse response is achieved. Refer to the LMC660 and LMC662 for a more detailed discussion on compensating for input capacitance.

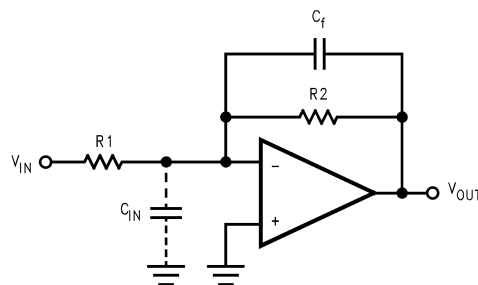

Figure 58. Cancelling the Effect of Input Capacitance

CAPACITIVE LOAD TOLERANCE

All rail-to-rail output swing operational amplifiers have voltage gain in the output stage. A compensation capacitor is normally included in this integrator stage. The frequency location of the dominant pole is affected by the resistive load on the amplifier. Capacitive load driving capability can be optimized by using an appropriate resistive load in parallel with the capacitive load (see [Typical Curves](#)).

Direct capacitive loading will reduce the phase margin of many op-amps. A pole in the feedback loop is created by the combination of the op-amp's output impedance and the capacitive load. This pole induces phase lag at the unity-gain crossover frequency of the amplifier resulting in either an oscillatory or underdamped pulse response. With a few external components, op amps can easily indirectly drive capacitive loads, as shown in [Figure 59](#).

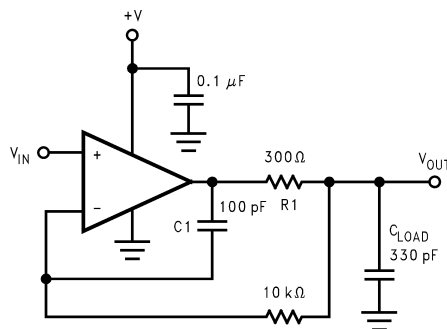

Figure 59. LMC6492/4 Noninverting Amplifier, Compensated to Handle Capacitive Loads

PRINTED-CIRCUIT-BOARD LAYOUT FOR HIGH-IMPEDANCE WORK

It is generally recognized that any circuit which must operate with less than 1000 pA of leakage current requires special layout of the PC board. When one wishes to take advantage of the ultra-low bias current of the LMC6492/4, typically 150 fA, it is essential to have an excellent layout. Fortunately, the techniques of obtaining low leakages are quite simple. First, the user must not ignore the surface leakage of the PC board, even though it may sometimes appear acceptably low, because under conditions of high humidity or dust or contamination, the surface leakage will be appreciable.

To minimize the effect of any surface leakage, lay out a ring of foil completely surrounding the LMC6492/4's inputs and the terminals of components connected to the op-amp's inputs, as in [Figure 60](#). To have a significant effect, guard rings should be placed on both the top and bottom of the PC board. This PC foil must then be connected to a voltage which is at the same voltage as the amplifier inputs, since no leakage current can flow between two points at the same potential. For example, a PC board trace-to-pad resistance of $10^{12}\Omega$, which is normally considered a very large resistance, could leak 5 pA if the trace were a 5V bus adjacent to the pad of the input.

This would cause a 33 times degradation from the LMC6492/4's actual performance. If a guard ring is used and held within 5 mV of the inputs, then the same resistance of $10^{11}\Omega$ will only cause 0.05 pA of leakage current. See [Figure 61](#) for typical connections of guard rings for standard op-amp configurations.

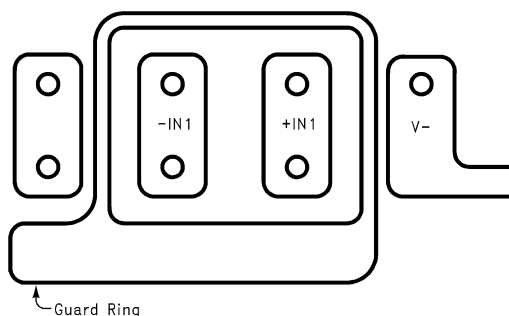

Figure 60. Examples of Guard Ring in PC Board Layout

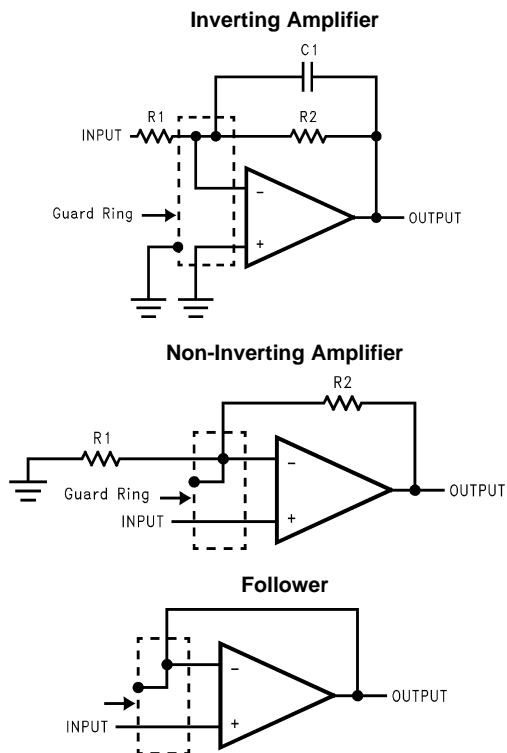
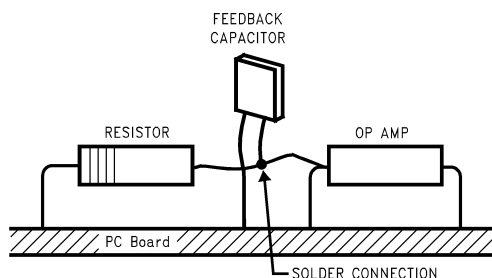

Figure 61. Typical Connections of Guard Rings

The designer should be aware that when it is inappropriate to lay out a PC board for the sake of just a few circuits, there is another technique which is even better than a guard ring on a PC board: Don't insert the amplifier's input pin into the board at all, but bend it up in the air and use only air as an insulator. Air is an excellent insulator. In this case you may have to forego some of the advantages of PC board construction, but the advantages are sometimes well worth the effort of using point-to-point up-in-the-air wiring. See Figure 62.



(Input pins are lifted out of PC board and soldered directly to components. All other pins connected to PC board).

Figure 62. Air Wiring

Application Circuits

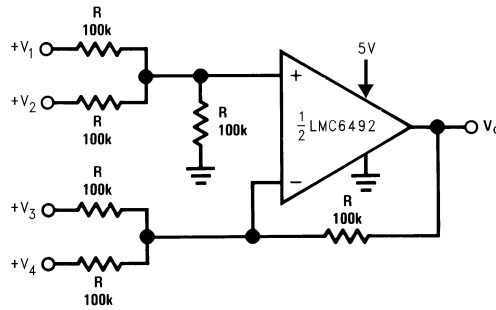

Where: $V_O = V_1 + V_2 - V_3 - V_4$
 $(V_1 + V_2 \geq (V_3 + V_4)$ to keep $V_O > 0V_{DC}$

Figure 63. DC Summing Amplifier ($V_{IN} \geq 0V_{DC}$ and $V_O \geq V_{DC}$)

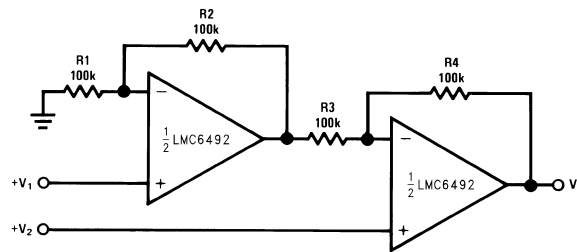

For

$$\frac{R1}{R2} = \frac{R4}{R3}$$

(CMRR depends on this resistor ratio match)

$$V_O = 1 + \frac{R4}{R3}(V_2 - V_1)$$

As shown: $V_O = 2(V_2 - V_1)$

Figure 64. High Input Z, DC Differential Amplifier

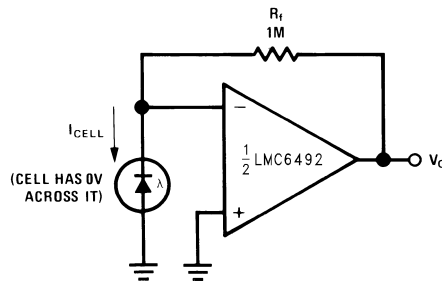
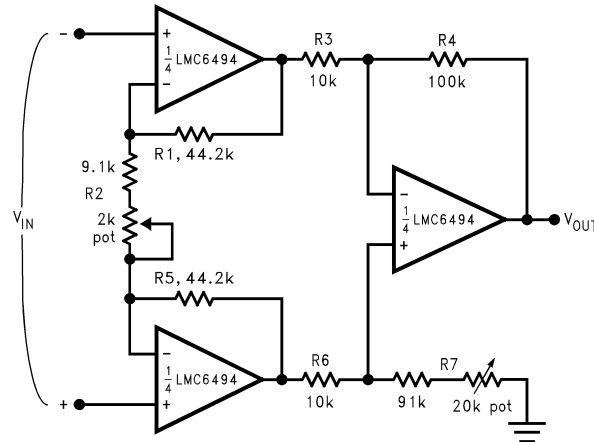

Figure 65. Photo Voltaic-Cell Amplifier



If $R_1 = R_5$, $R_3 = R_6$, and $R_4 = R_7$; then

$$\frac{V_{OUT}}{V_{IN}} = \frac{R_2 + 2R_1}{R_2} \times \frac{R_4}{R_3}$$

$\therefore A_v \approx 100$ for circuit shown ($R_2 = 9.3k$).

Figure 66. Instrumentation Amplifier

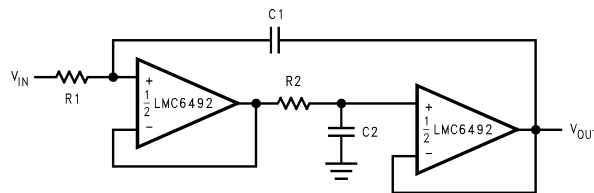

$$R_1 = R_2, C_1 = C_2; f = \frac{1}{2\pi R_1 C_1}; \text{Damping Factor} = \frac{1}{2} \sqrt{\frac{C_2}{C_1}} \sqrt{\frac{R_2}{R_1}}$$

Figure 67. Rail-to-Rail Single Supply Low Pass Filter

This low-pass filter circuit can be used as an anti-aliasing filter with the same supply as the A/D converter. Filter designs can also take advantage of the LMC6492/4 ultra-low input current. The ultra-low input current yields negligible offset error even when large value resistors are used. This in turn allows the use of smaller valued capacitors which take less board space and cost less.

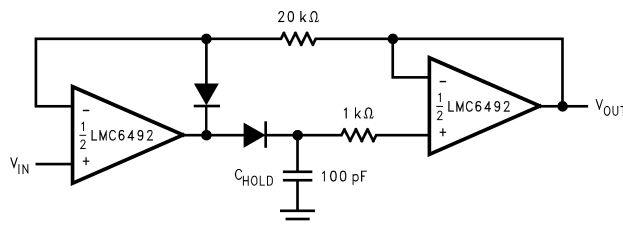
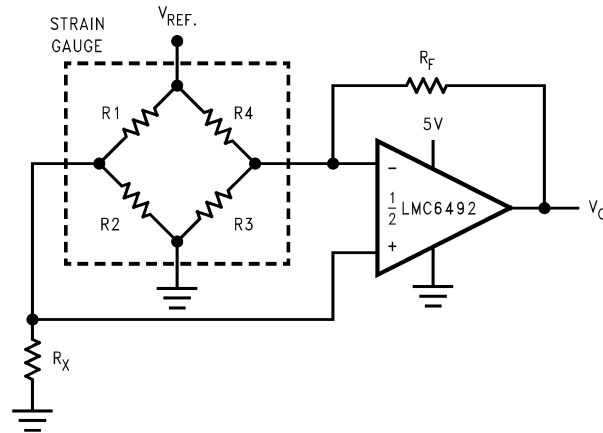

Figure 68. Low Voltage Peak Detector with Rail-to-Rail Peak Capture Range

Dielectric absorption and leakage is minimized by using a polystyrene or polypropylene hold capacitor. The droop rate is primarily determined by the value of C_H and diode leakage current. Select low-leakage current diodes to minimize drooping.



$$R_f = R_x$$

$$R_f \gg R_1, R_2, R_3, \text{ and } R_4$$

$$V_O = \left(\frac{R_2}{R_1 + R_2} - \frac{R_3}{R_4 + R_3} \right) \frac{R_f (R_3 + R_4)}{R_3 R_4} V_{REF}$$

Figure 69. Pressure Sensor

In a manifold absolute pressure sensor application, a strain gauge is mounted on the intake manifold in the engine unit. Manifold pressure causes the sensing resistors, R1, R2, R3 and R4 to change. The resistors change in a way such that R2 and R4 increase by the same amount R1 and R3 decrease. This causes a differential voltage between the input of the amplifier. The gain of the amplifier is adjusted by R_f.

Spice Macromodel

A spice macromodel is available for the LMC6492/4. This model includes accurate simulation of:

- Input common-mode voltage range
- Frequency and transient response
- GBW dependence on loading conditions
- Quiescent and dynamic supply current
- Output swing dependence on loading conditions

and many other characteristics as listed on the macromodel disk.

Contact your local Texas Instruments sales office to obtain an operational amplifier spice model library disk.

REVISION HISTORY

Changes from Revision C (March 2013) to Revision D	Page
• Changed layout of National Data Sheet to TI format	20

PACKAGING INFORMATION

Orderable Device	Status (1)	Package Type	Package Drawing	Pins	Package Qty	Eco Plan (2)	Lead/Ball Finish (6)	MSL Peak Temp (3)	Op Temp (°C)	Device Marking (4/5)	Samples
LMC6492AEM	NRND	SOIC	D	8	95	TBD	Call TI	Call TI	-40 to 125	LMC64 92AEM	
LMC6492AEM/NOPB	ACTIVE	SOIC	D	8	95	Green (RoHS & no Sb/Br)	CU SN	Level-1-260C-UNLIM	-40 to 125	LMC64 92AEM	Samples
LMC6492AEMX/NOPB	ACTIVE	SOIC	D	8	2500	Green (RoHS & no Sb/Br)	CU SN	Level-1-260C-UNLIM	-40 to 125	LMC64 92AEM	Samples
LMC6492BEM/NOPB	ACTIVE	SOIC	D	8	95	Green (RoHS & no Sb/Br)	CU SN	Level-1-260C-UNLIM	-40 to 125	LMC64 92BEM	Samples
LMC6492BEMX/NOPB	ACTIVE	SOIC	D	8	2500	Green (RoHS & no Sb/Br)	CU SN	Level-1-260C-UNLIM	-40 to 125	LMC64 92BEM	Samples
LMC6494AEM	NRND	SOIC	D	14	55	TBD	Call TI	Call TI	-40 to 125	LMC6494 AEM	
LMC6494AEM/NOPB	ACTIVE	SOIC	D	14	55	Green (RoHS & no Sb/Br)	CU SN	Level-1-260C-UNLIM	-40 to 125	LMC6494 AEM	Samples
LMC6494AEMX/NOPB	ACTIVE	SOIC	D	14	2500	Green (RoHS & no Sb/Br)	CU SN	Level-1-260C-UNLIM	-40 to 125	LMC6494 AEM	Samples
LMC6494BEM/NOPB	ACTIVE	SOIC	D	14	55	Green (RoHS & no Sb/Br)	CU SN	Level-1-260C-UNLIM	-40 to 125	LMC6494 BEM	Samples
LMC6494BEMX/NOPB	ACTIVE	SOIC	D	14	2500	Green (RoHS & no Sb/Br)	CU SN	Level-1-260C-UNLIM	-40 to 125	LMC6494 BEM	Samples

(1) The marketing status values are defined as follows:

ACTIVE: Product device recommended for new designs.

LIFEBUY: TI has announced that the device will be discontinued, and a lifetime-buy period is in effect.

NRND: Not recommended for new designs. Device is in production to support existing customers, but TI does not recommend using this part in a new design.

PREVIEW: Device has been announced but is not in production. Samples may or may not be available.

OBSELETE: TI has discontinued the production of the device.

(2) **RoHS:** TI defines "RoHS" to mean semiconductor products that are compliant with the current EU RoHS requirements for all 10 RoHS substances, including the requirement that RoHS substance do not exceed 0.1% by weight in homogeneous materials. Where designed to be soldered at high temperatures, "RoHS" products are suitable for use in specified lead-free processes. TI may reference these types of products as "Pb-Free".

RoHS Exempt: TI defines "RoHS Exempt" to mean products that contain lead but are compliant with EU RoHS pursuant to a specific EU RoHS exemption.

Green: TI defines "Green" to mean the content of Chlorine (Cl) and Bromine (Br) based flame retardants meet JS709B low halogen requirements of <=1000ppm threshold. Antimony trioxide based flame retardants must also meet the <=1000ppm threshold requirement.

(3) MSL, Peak Temp. - The Moisture Sensitivity Level rating according to the JEDEC industry standard classifications, and peak solder temperature.

(4) There may be additional marking, which relates to the logo, the lot trace code information, or the environmental category on the device.

(5) Multiple Device Markings will be inside parentheses. Only one Device Marking contained in parentheses and separated by a "~" will appear on a device. If a line is indented then it is a continuation of the previous line and the two combined represent the entire Device Marking for that device.

(6) Lead/Ball Finish - Orderable Devices may have multiple material finish options. Finish options are separated by a vertical ruled line. Lead/Ball Finish values may wrap to two lines if the finish value exceeds the maximum column width.

Important Information and Disclaimer:The information provided on this page represents TI's knowledge and belief as of the date that it is provided. TI bases its knowledge and belief on information provided by third parties, and makes no representation or warranty as to the accuracy of such information. Efforts are underway to better integrate information from third parties. TI has taken and continues to take reasonable steps to provide representative and accurate information but may not have conducted destructive testing or chemical analysis on incoming materials and chemicals. TI and TI suppliers consider certain information to be proprietary, and thus CAS numbers and other limited information may not be available for release.

In no event shall TI's liability arising out of such information exceed the total purchase price of the TI part(s) at issue in this document sold by TI to Customer on an annual basis.

TAPE AND REEL INFORMATION



QUADRANT ASSIGNMENTS FOR PIN 1 ORIENTATION IN TAPE



*All dimensions are nominal

Device	Package Type	Package Drawing	Pins	SPQ	Reel Diameter (mm)	Reel Width W1 (mm)	A0 (mm)	B0 (mm)	K0 (mm)	P1 (mm)	W (mm)	Pin1 Quadrant
LMC6492AEMX/NOPB	SOIC	D	8	2500	330.0	12.4	6.5	5.4	2.0	8.0	12.0	Q1
LMC6492BEMX/NOPB	SOIC	D	8	2500	330.0	12.4	6.5	5.4	2.0	8.0	12.0	Q1
LMC6494AEMX/NOPB	SOIC	D	14	2500	330.0	16.4	6.5	9.35	2.3	8.0	16.0	Q1
LMC6494BEMX/NOPB	SOIC	D	14	2500	330.0	16.4	6.5	9.35	2.3	8.0	16.0	Q1

TAPE AND REEL BOX DIMENSIONS

*All dimensions are nominal

Device	Package Type	Package Drawing	Pins	SPQ	Length (mm)	Width (mm)	Height (mm)
LMC6492AEMX/NOPB	SOIC	D	8	2500	367.0	367.0	35.0
LMC6492BEMX/NOPB	SOIC	D	8	2500	367.0	367.0	35.0
LMC6494AEMX/NOPB	SOIC	D	14	2500	367.0	367.0	35.0
LMC6494BEMX/NOPB	SOIC	D	14	2500	367.0	367.0	35.0

D (R-PDSO-G14)

PLASTIC SMALL OUTLINE



- NOTES:
- A. All linear dimensions are in inches (millimeters).
 - B. This drawing is subject to change without notice.
 - C. Body length does not include mold flash, protrusions, or gate burrs. Mold flash, protrusions, or gate burrs shall not exceed 0.006 (0,15) each side.
 - D. Body width does not include interlead flash. Interlead flash shall not exceed 0.017 (0,43) each side.
 - E. Reference JEDEC MS-012 variation AB.

D (R-PDSO-G14)

PLASTIC SMALL OUTLINE



4211283-3/E 08/12

- NOTES:
- All linear dimensions are in millimeters.
 - This drawing is subject to change without notice.
 - Publication IPC-7351 is recommended for alternate designs.
 - Laser cutting apertures with trapezoidal walls and also rounding corners will offer better paste release. Customers should contact their board assembly site for stencil design recommendations. Refer to IPC-7525 for other stencil recommendations.
 - Customers should contact their board fabrication site for solder mask tolerances between and around signal pads.



D0008A

PACKAGE OUTLINE

SOIC - 1.75 mm max height

SMALL OUTLINE INTEGRATED CIRCUIT



4214825/C 02/2019

NOTES:

1. Linear dimensions are in inches [millimeters]. Dimensions in parenthesis are for reference only. Controlling dimensions are in inches. Dimensioning and tolerancing per ASME Y14.5M.
2. This drawing is subject to change without notice.
3. This dimension does not include mold flash, protrusions, or gate burrs. Mold flash, protrusions, or gate burrs shall not exceed $.006$ [0.15] per side.
4. This dimension does not include interlead flash.
5. Reference JEDEC registration MS-012, variation AA.

EXAMPLE BOARD LAYOUT

D0008A

SOIC - 1.75 mm max height

SMALL OUTLINE INTEGRATED CIRCUIT



LAND PATTERN EXAMPLE
 EXPOSED METAL SHOWN
 SCALE:8X



SOLDER MASK DETAILS

4214825/C 02/2019

NOTES: (continued)

- 6. Publication IPC-7351 may have alternate designs.
- 7. Solder mask tolerances between and around signal pads can vary based on board fabrication site.

EXAMPLE STENCIL DESIGN

D0008A

SOIC - 1.75 mm max height

SMALL OUTLINE INTEGRATED CIRCUIT



SOLDER PASTE EXAMPLE
BASED ON .005 INCH [0.125 MM] THICK STENCIL
SCALE:8X

4214825/C 02/2019

NOTES: (continued)

8. Laser cutting apertures with trapezoidal walls and rounded corners may offer better paste release. IPC-7525 may have alternate design recommendations.
9. Board assembly site may have different recommendations for stencil design.

IMPORTANT NOTICE AND DISCLAIMER

TI PROVIDES TECHNICAL AND RELIABILITY DATA (INCLUDING DATASHEETS), DESIGN RESOURCES (INCLUDING REFERENCE DESIGNS), APPLICATION OR OTHER DESIGN ADVICE, WEB TOOLS, SAFETY INFORMATION, AND OTHER RESOURCES "AS IS" AND WITH ALL FAULTS, AND DISCLAIMS ALL WARRANTIES, EXPRESS AND IMPLIED, INCLUDING WITHOUT LIMITATION ANY IMPLIED WARRANTIES OF MERCHANTABILITY, FITNESS FOR A PARTICULAR PURPOSE OR NON-INFRINGEMENT OF THIRD PARTY INTELLECTUAL PROPERTY RIGHTS.

These resources are intended for skilled developers designing with TI products. You are solely responsible for (1) selecting the appropriate TI products for your application, (2) designing, validating and testing your application, and (3) ensuring your application meets applicable standards, and any other safety, security, or other requirements. These resources are subject to change without notice. TI grants you permission to use these resources only for development of an application that uses the TI products described in the resource. Other reproduction and display of these resources is prohibited. No license is granted to any other TI intellectual property right or to any third party intellectual property right. TI disclaims responsibility for, and you will fully indemnify TI and its representatives against, any claims, damages, costs, losses, and liabilities arising out of your use of these resources.

TI's products are provided subject to TI's Terms of Sale (www.ti.com/legal/termsofsale.html) or other applicable terms available either on ti.com or provided in conjunction with such TI products. TI's provision of these resources does not expand or otherwise alter TI's applicable warranties or warranty disclaimers for TI products.

Mailing Address: Texas Instruments, Post Office Box 655303, Dallas, Texas 75265
Copyright © 2019, Texas Instruments Incorporated

Looking for pricing, stock, or lifecycle information?

Click below to explore more details on WIN SOURCE:

 [View LMC6494AEM/NOPB on WIN SOURCE](#)

 [Texas Instruments](#) Information

Optimize Your Supply Chain with WIN SOURCE Solutions

-  Global Sourcing Solution
-  Obsolete Management
-  Cost Control Management
-  Shortage Management
-  Alternative Solution
-  Excess Inventory Management