



**THE DATASHEET OF
MAX208ECAG+T**





Evaluation Kit Available



Design Resources



Tools and Models



Support

Click [here](#) to ask an associate for production status of specific part numbers.

±15kV ESD-Protected, 5V RS-232 Transceivers

MAX202E–MAX213E, MAX232E/MAX241E

General Description

The MAX202E–MAX213E, MAX232E, and MAX241E are a family of RS-232 and V.28 transceivers with high ±15kV ESD HBM protection and integrated charge pump circuitry for single +5V supply operation. The various combinations of features are outlined in the *Selector Guide*. The drivers and receivers for all ten devices meet all EIA/TIA-232E and CCITT V.28 specifications at data rates up to 120kbps when loaded.

The MAX211E/MAX213E/MAX241E are available in 28-pin SO and SSOP packages. The MAX202E/MAX232E come in 16-pin TSSOP, narrow SO, wide SO, and DIP packages. The MAX203E comes in a 20-pin DIP/SO package, and needs no external charge-pump capacitors. The MAX205E comes in a 24-pin wide DIP package, and also eliminates external charge-pump capacitors.

Applications

- Battery-Powered Equipment
- Hand-Held Equipment
- Portable Diagnostics Equipment

Benefits and Features

- Saves Board Space
 - Integrated High ±15kV HBM ESD Protection
 - Integrated Charge Pump Circuitry
 - Eliminates the Need for a Bipolar ±12V Supply
 - Enables Single Supply Operation From +5V Supply
 - Integrated 0.1µF Capacitors (MAX203E, MAX205E)
 - 24 pin SSOP Package Saves up to 40% Versus SO Package
- Saves Power for Reduced Power Requirements
 - 1µA Shutdown Mode
 - 15µA Shutdown Mode for MAX213E

Ordering Information

PART	TEMP RANGE	PIN-PACKAGE
MAX202ECE	0°C to +70°C	16 Plastic DIP
MAX202ECSE	0°C to +70°C	16 Narrow SO

Ordering Information continued at end of data sheet.

Pin Configurations and Typical Operating Circuits appear at end of data sheet.

AutoShutdown and UCSP are trademarks of Maxim Integrated Products, Inc.

Selector Guide

PART	NO. OF RS-232 DRIVERS	NO. OF RS-232 RECEIVERS	RECEIVERS ACTIVE IN SHUTDOWN	NO. OF EXTERNAL CAPACITORS (µF)	LOW-POWER SHUTDOWN	TTL TRI-STATE
MAX202E	2	2	0	4 (0.1)	No	No
MAX203E	2	2	0	None	No	No
MAX205E	5	5	0	None	Yes	Yes
MAX206E	4	3	0	4 (0.1)	Yes	Yes
MAX207E	5	3	0	4 (0.1)	No	No
MAX208E	4	4	0	4 (0.1)	No	No
MAX211E	4	5	0	4 (0.1)	Yes	Yes
MAX213E	4	5	2	4 (0.1)	Yes	Yes
MAX232E	2	2	0	4 (1)	No	No
MAX241E	4	5	0	4 (1)	Yes	Yes

19-0175; Rev 8; 1/21

MAX202E–MAX213E, MAX232E/MAX241E

±15kV ESD-Protected,
5V RS-232 Transceivers

Absolute Maximum Ratings

V _{CC}	-0.3V to +6V	20-Pin Plastic DIP (derate 11.11mW/°C above +70°C).....	889mW
V+.....	(V _{CC} - 0.3V) to +14V	20-Pin SO (derate 10.00mW/°C above +70°C).....	800mW
V-.....	-14V to +0.3V	24-Pin Narrow Plastic DIP	
Input Voltages		(derate 13.33mW/°C above +70°C).....	1.07W
T_IN.....	-0.3V to (V+ + 0.3V)	24-Pin Wide Plastic DIP	
R_IN.....	±30V	(derate 14.29mW/°C above +70°C).....	1.14W
Output Voltages		24-Pin SO (derate 11.76mW/°C above +70°C).....	941mW
T_OUT.....	(V- - 0.3V) to (V+ + 0.3V)	24-Pin SSOP (derate 8.00mW/°C above +70°C).....	640mW
R_OUT.....	-0.3V to (V _{CC} + 0.3V)	28-Pin SO (derate 12.50mW/°C above +70°C).....	1W
Short-Circuit Duration, T_OUT.....	Continuous	28-Pin SSOP (derate 9.52mW/°C above +70°C).....	762mW
Continuous Power Dissipation (T _A = +70°C)		Operating Temperature Ranges	
16-Pin Plastic DIP (derate 10.53mW/°C above +70°C)...	842mW	MAX2__EC__.....	0°C to +70°C
16-Pin Narrow SO (derate 8.70mW/°C above +70°C).....	696mW	MAX2__EE__.....	-40°C to +85°C
16-Pin Wide SO (derate 9.52mW/°C above +70°C)...	762mW	Storage Temperature Range.....	65°C to +165°C
16-Pin TSSOP (derate 9.4mW/°C above +70°C).....	755mW	Lead Temperature (soldering, 10s).....	+300°C

Stresses beyond those listed under "Absolute Maximum Ratings" may cause permanent damage to the device. These are stress ratings only, and functional operation of the device at these or any other conditions beyond those indicated in the operational sections of the specifications is not implied. Exposure to absolute maximum rating conditions for extended periods may affect device reliability.

Electrical Characteristics

(V_{CC} = +5V ±10% for MAX202E/206E/208E/211E/213E/232E/241E; V_{CC} = +5V ±5% for MAX203E/205E/207E; C1–C4 = 0.1µF for MAX202E/206E/207E/208E/211E/213E; C1–C4 = 1µF for MAX232E/241E; T_A = T_{MIN} to T_{MAX}; unless otherwise noted. Typical values are at T_A = +25°C.)

PARAMETER	SYMBOL	CONDITIONS	MIN	TYP	MAX	UNITS
DC CHARACTERISTICS						
V _{CC} Supply Current	I _{CC}	No load, T _A = +25°C	MAX202E/203E	8	15	mA
			MAX205E–208E	11	20	
			MAX211E/213E	14	20	
			MAX232E	5	10	
			MAX241E	7	15	
Shutdown Supply Current		T _A = +25°C, Figure 1	MAX205E/206E	1	10	µA
			MAX211E/241E	1	10	
			MAX213E	15	50	
LOGIC						
Input Pullup Current		T_IN = 0V (MAX205E–208E/211E/213E/241E)		15	200	µA
Input Leakage Current		T_IN = 0V to V _{CC} (MAX202E/203E/232E)			±10	µA
Input Threshold Low	V _{IL}	T_IN; EN, $\overline{\text{SHDN}}$ (MAX213E) or $\overline{\text{EN}}$, SHDN (MAX205E–208E/211E/241E)			0.8	V
Input Threshold High	V _{IH}	T_IN	2.0			V
		EN, $\overline{\text{SHDN}}$ (MAX213E) or $\overline{\text{EN}}$, SHDN (MAX205E–208E/211E/241E)	2.4			
Output-Voltage Low	V _{OL}	R_OUT; I _{OUT} = 3.2mA (MAX202E/203E/232E) or I _{OUT} = 1.6mA (MAX205E/208E/211E/213E/241E)			0.4	V
Output-Voltage High	V _{OH}	R_OUT; I _{OUT} = -1.0mA	3.5	V _{CC} - 0.4		V
Output Leakage Current		$\overline{\text{EN}} = V_{CC}$, EN = 0V, 0V ≤ R _{OUT} ≤ V _{CC} , MAX205E–208E/211E/213E/241E outputs disabled		±0.05	±10	µA

MAX202E–MAX213E, MAX232E/MAX241E

±15kV ESD-Protected,
5V RS-232 Transceivers

Electrical Characteristics (continued)

($V_{CC} = +5V \pm 10\%$ for MAX202E/206E/208E/211E/213E/232E/241E; $V_{CC} = +5V \pm 5\%$ for MAX203E/205E/207E; C1–C4 = 0.1 μ F for MAX202E/206E/207E/208E/211E/213E; C1–C4 = 1 μ F for MAX232E/241E; $T_A = T_{MIN}$ to T_{MAX} ; unless otherwise noted. Typical values are at $T_A = +25^\circ\text{C}$.)

PARAMETER	SYMBOL	CONDITIONS	MIN	TYP	MAX	UNITS	
EIA/TIA-232E RECEIVER INPUTS							
Input Voltage Range			-30		30	V	
Input Threshold Low		$T_A = +25^\circ\text{C}$, $V_{CC} = 5V$	All parts, normal operation		0.8	1.2	V
			MAX213E, $\overline{\text{SHDN}} = 0V$, $\text{EN} = V_{CC}$		0.6	1.5	
Input Threshold High		$T_A = +25^\circ\text{C}$, $V_{CC} = 5V$	All parts, normal operation		1.7	2.4	V
			MAX213E (R4, R5), $\overline{\text{SHDN}} = 0V$, $\text{EN} = V_{CC}$		1.5	2.4	
Input Hysteresis		$V_{CC} = 5V$, no hysteresis in shutdown	0.2	0.5	1.0	V	
Input Resistance		$T_A = +25^\circ\text{C}$, $V_{CC} = 5V$	3	5	7	k Ω	
EIA/TIA-232E TRANSMITTER OUTPUTS							
Output Voltage Swing		All drivers loaded with 3k Ω to ground (Note 1)	±5	±9		V	
Output Resistance		$V_{CC} = V_+ = V_- = 0V$, $V_{OUT} = \pm 2V$	300			Ω	
Output Short-Circuit Current				±10	±60	mA	
TIMING CHARACTERISTICS							
Maximum Data Rate		$R_L = 3k\Omega$ to 7k Ω , $C_L = 50pF$ to 1000pF, one transmitter switching	120			kbps	
Receiver Propagation Delay	t_{PLHR} , t_{PHLR}	$C_L = 150pF$	All parts, normal operation		0.5	10	μ s
			MAX213E (R4, R5), $\overline{\text{SHDN}} = 0V$, $\text{EN} = V_{CC}$		4	40	
Receiver Output Enable Time		MAX205E/206E/211E/213E/241E normal operation, Figure 2		600		ns	
Receiver Output Disable Time		MAX205E/206E/211E/213E/241E normal operation, Figure 2		200		ns	
Transmitter Propagation Delay	t_{PLHT} , t_{PHLT}	$R_L = 3k\Omega$, $C_L = 2500pF$, all transmitters loaded		2		μ s	
Transition-Region Slew Rate		$T_A = +25^\circ\text{C}$, $V_{CC} = 5V$, $R_L = 3k\Omega$ to 7k Ω , $C_L = 50pF$ to 1000pF, measured from -3V to +3V or +3V to -3V, Figure 3	3	6	30	V/ μ s	
ESD PERFORMANCE: TRANSMITTER OUTPUTS, RECEIVER INPUTS							
ESD-Protection Voltage		Human Body Model		±15		kV	
		IEC1000-4-2, Contact Discharge		±8			
		IEC1000-4-2, Air-Gap Discharge		±15			

Note 1: MAX211EE_ _ tested with $V_{CC} = +5V \pm 5\%$.

Typical Operating Characteristics

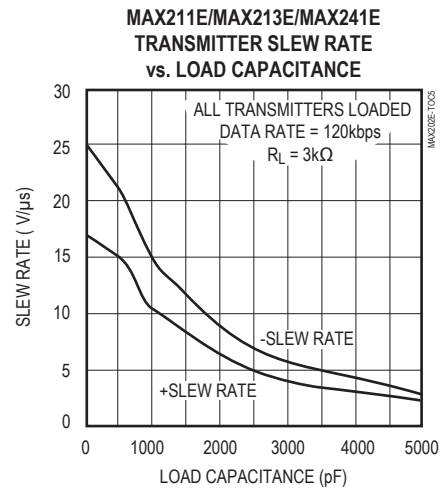
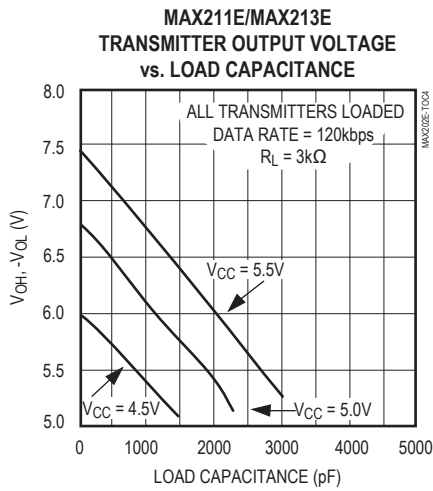
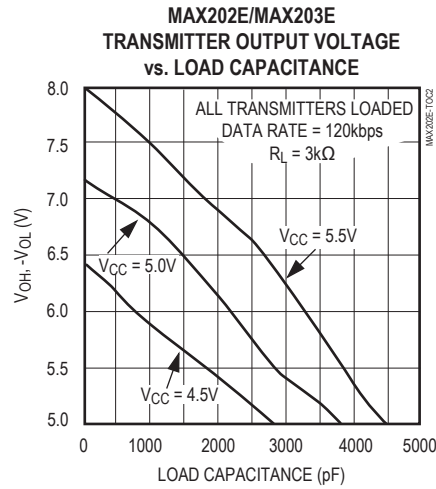

Typical Operating Characteristics (continued)

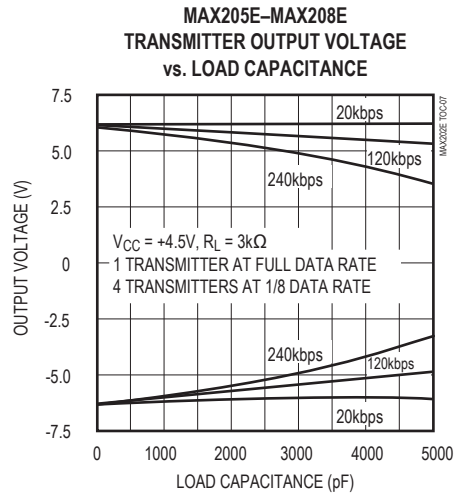

MAX202E–MAX213E, MAX232E/MAX241E

±15kV ESD-Protected,
5V RS-232 Transceivers

Pin Descriptions

MAX202E/MAX232E

PIN		NAME	FUNCTION
DIP/SO/TSSOP	LCC		
1, 3	2, 4	C1+, C1-	Terminals for Positive Charge-Pump Capacitor
2	3	V+	+2V _{CC} Voltage Generated by the Charge Pump
4, 5	5, 7	C2+, C2-	Terminals for Negative Charge-Pump Capacitor
6	8	V	-2V _{CC} Voltage Generated by the Charge Pump
7, 14	9, 18	T_OUT	RS-232 Driver Outputs
8, 13	10, 17	R_IN	RS-232 Receiver Inputs
9, 12	12, 15	R_OUT	RS-232 Receiver Outputs
10, 11	13, 14	T_IN	RS-232 Driver Inputs
15	19	GND	Ground
16	20	V _{CC}	+4.5V to +5.5V Supply-Voltage Input
—	1, 6, 11, 16	N.C.	No Connection—Not Internally Connected

MAX203E

PIN		NAME	FUNCTION
DIP	SO		
1, 2	1, 2	T_IN	RS-232 Driver Inputs
3, 20	3, 20	R_OUT	RS-232 Receiver Outputs
4, 19	4, 19	R_IN	RS-232 Receiver Inputs
5, 18	5, 18	T_OUT	RS-232 Transmitter Outputs
6, 9	6, 9	GND	Ground
7	7	V _{CC}	+4.5V to +5.5V Supply-Voltage Input
8	13	C1+	Make no connection to this pin.
10, 16	11, 16	C2-	Connect pins together.
12, 17	10, 17	V-	-2V _{CC} Voltage Generated by the Charge Pump. Connect pins together.
13	14	C1-	Make no connection to this pin.
14	8	V+	+2V _{CC} Voltage Generated by the Charge Pump
11, 15	12, 15	C2+	Connect pins together.

MAX205E

PIN	NAME	FUNCTION
1–4, 19	T_OUT	RS-232 Driver Outputs
5, 10, 13, 18, 24	R_IN	RS-232 Receiver Inputs
6, 9, 14, 17, 23	R_OUT	TTL/CMOS Receiver Outputs. All receivers are inactive in shutdown.
7, 8, 15, 16, 22	T_IN	TTL/CMOS Driver Inputs. Internal pullups to V _{CC} .
11	GND	Ground
12	V _{CC}	+4.75V to +5.25V Supply Voltage
20	$\overline{\text{EN}}$	Receiver Enable—Active Low
21	SHDN	Shutdown Control—Active High

Pin Descriptions (continued)

MAX206E

PIN	NAME	FUNCTION
1, 2, 3, 24	T_OUT	RS-232 Driver Outputs
4, 16, 23	R_IN	RS-232 Receiver Inputs
5, 17, 22	R_OUT	TTL/CMOS Receiver Outputs. All receivers are inactive in shutdown.
6, 7, 18, 19	T_IN	TTL/CMOS Driver Inputs. Internal pullups to V _{CC} .
8	GND	Ground
9	V _{CC}	+4.5V to +5.5V Supply Voltage
10, 12	C1+, C1-	Terminals for Positive Charge-Pump Capacitor
11	V+	+2V _{CC} Generated by the Charge Pump
13, 14	C2+, C2-	Terminals for Negative Charge-Pump Capacitor
15	V-	-2V _{CC} Generated by the Charge Pump
20	EN	Receiver Enable—Active Low
21	SHDN	Shutdown Control—Active High

MAX207E

PIN	NAME	FUNCTION
1, 2, 3, 20, 24	T_OUT	RS-232 Driver Outputs
4, 16, 23	R_IN	RS-232 Receiver Inputs
5, 17, 22	R_OUT	TTL/CMOS Receiver Outputs. All receivers are inactive in shutdown.
6, 7, 18, 19, 21	T_IN	TTL/CMOS Driver Inputs. Internal pullups to V _{CC} .
8	GND	Ground
9	V _{CC}	+4.75V to +5.25V Supply Voltage
10, 12	C1+, C1-	Terminals for Positive Charge-Pump Capacitor
11	V+	+2V _{CC} Generated by the Charge Pump
13, 14	C2+, C2-	Terminals for Negative Charge-Pump Capacitor
15	V-	-2V _{CC} Generated by the Charge Pump

MAX208E

PIN	NAME	FUNCTION
1, 2, 20, 24	T_OUT	RS-232 Driver Outputs
3, 7, 16, 23	R_IN	RS-232 Receiver Inputs
4, 6, 17, 22	R_OUT	TTL/CMOS Receiver Outputs. All receivers are inactive in shutdown.
5, 18, 19, 21	T_IN	TTL/CMOS Driver Inputs. Internal pullups to V _{CC} .
8	GND	Ground
9	V _{CC}	+4.5V to +5.5V Supply Voltage
10, 12	C1+, C1-	Terminals for Positive Charge-Pump Capacitor
11	V+	+2V _{CC} Generated by the Charge Pump
13, 14	C2+, C2-	Terminals for Negative Charge-Pump Capacitor
15	V-	-2V _{CC} Generated by the Charge Pump

Pin Descriptions (continued)

MAX211E/MAX213E/MAX241E

PIN	NAME	FUNCTION
1, 2, 3, 28	VT_OUT	RS-232 Driver Outputs
4, 9, 18, 23, 27	R_IN	RS-232 Receiver Inputs
5, 8, 19, 22, 26	R_OUT	TTL/CMOS Receiver Outputs. For the MAX213E, receivers R4 and R5 are active in shutdown mode when EN = 1. For the MAX211E and MAX241E, all receivers are inactive in shutdown.
6, 7, 20, 21	T_IN	TTL/CMOS Driver Inputs. Only the MAX211E, MAX213E, and MAX241E have internal pullups to V _{CC} .
10	GND	Ground
11	V _{CC}	+4.5V to +5.5V Supply Voltage
12, 14	C1+, C1-	Terminals for Positive Charge-Pump Capacitor
13	V+	+2V _{CC} Voltage Generated by the Charge Pump
15, 16	C2+, C2-	Terminals for Negative Charge-Pump Capacitor
17	V-	-2V _{CC} Voltage Generated by the Charge Pump
24	$\overline{\text{EN}}$	Receiver Enable—Active Low (MAX211E, MAX241E)
	EN	Receiver Enable—Active High (MAX213E)
25	SHDN	Shutdown Control—Active High (MAX211E, MAX241E)
	$\overline{\text{SHDN}}$	Shutdown Control—Active Low (MAX213E)



Figure 1. Shutdown-Current Test Circuit (MAX206E, MAX211E/MAX213E/MAX241E)



Figure 2. Receiver Output Enable and Disable Timing (MAX205E/MAX206E/MAX211E/MAX213E/MAX241E)



Figure 3. Transition Slew-Rate Circuit

Detailed Description

The MAX202E–MAX213E, MAX232E/MAX241E consist of three sections: charge-pump voltage converters, drivers (transmitters), and receivers. These E versions provide extra protection against ESD. They survive ±15kV discharges to the RS-232 inputs and outputs, tested using the Human Body Model. When tested according to IEC1000-4-2, they survive ±8kV contact-discharges and ±15kV air-gap discharges. The rugged E versions are intended for use in harsh environments or applications where the RS-232 connection is frequently changed (such as notebook computers). The standard (non-“E”) MAX202, MAX203, MAX205–MAX208, MAX211, MAX213, MAX232, and MAX241 are recommended for applications where cost is critical.

+5V to ±10V Dual Charge-Pump Voltage Converter

The +5V to ±10V conversion is performed by dual charge-pump voltage converters (Figure 4). The first charge-pump converter uses capacitor C1 to double the +5V into +10V, storing the +10V on the output filter capacitor, C3.

The second uses C2 to invert the +10V into -10V, storing the -10V on the V- output filter capacitor, C4.

In shutdown mode, V+ is internally connected to V_{CC} by a 1kΩ pull-down resistor, and V- is internally connected to ground by a 1kΩ pull up resistor.

RS-232 Drivers

With V_{CC} = 5V, the typical driver output voltage swing is ±8V when loaded with a nominal 5kΩ RS-232 receiver. The output swing is guaranteed to meet EIA/TIA-232E and V.28 specifications that call for ±5V minimum output levels under worst-case conditions. These include a 3kΩ load, minimum V_{CC}, and maximum operating temperature. The open-circuit output voltage swings from (V+ - 0.6V) to V-.

Input thresholds are CMOS/TTL compatible. The unused drivers' inputs on the MAX205E–MAX208E, MAX211E, MAX213E, and MAX241E can be left unconnected because 400kΩ pull up resistors to V_{CC} are included on-chip. Since all drivers invert, the pull up resistors force the unused drivers' outputs low. The MAX202E, MAX203E, and MAX232E do not have pull up resistors on the transmitter inputs.



Figure 4. Charge-Pump Diagram

When in low-power shutdown mode, the MAX205E/MAX206E/MAX211E/MAX213E/MAX241E driver outputs are turned off and draw only leakage currents—even if they are back-driven with voltages between 0V and 12V. Below -0.5V in shutdown, the transmitter output is diode-clamped to ground with a 1kΩ series impedance.

RS-232 Receivers

The receivers convert the RS-232 signals to CMOS-logic output levels. The guaranteed 0.8V and 2.4V receiver input thresholds are significantly tighter than the ±3V thresholds required by the EIA/TIA-232E specification. This allows the receiver inputs to respond to TTL/CMOS-logic levels, as well as RS-232 levels.

The guaranteed 0.8V input low threshold ensures that receivers shorted to ground have a logic 1 output. The 5kΩ input resistance to ground ensures that a receiver with its input left open will also have a logic 1 output.

Receiver inputs have approximately 0.5V hysteresis. This provides clean output transitions, even with slow rise/fall-time signals with moderate amounts of noise and ringing.

In shutdown, the MAX213E's R4 and R5 receivers have no hysteresis.

Shutdown and Enable Control (MAX205E/MAX206E/MAX211E/ MAX213E/MAX241E)

In shutdown mode, the charge pumps are turned off, V+ is pulled down to V_{CC}, V- is pulled to ground, and the transmitter outputs are disabled. This reduces supply current typically to 1μA (15μA for the MAX213E). The time required to exit shutdown is under 1ms, as shown in Figure 5.

Receivers

All MAX213E receivers, except R4 and R5, are put into a high-impedance state in shutdown mode (see Tables 1a and 1b). The MAX213E's R4 and R5 receivers still function in shutdown mode. These two awake-in-shutdown receivers can monitor external activity while maintaining minimal power consumption.

The enable control is used to put the receiver outputs into a high-impedance state, to allow wire-OR connection of two EIA/TIA-232E ports (or ports of different types) at the UART. It has no effect on the RS-232 drivers or the charge pumps.

Note: The enable control pin is active low for the MAX211E/MAX241E (EN), but is active high for the MAX213E (EN). The shutdown control pin is active

MAX202E–MAX213E, MAX232E/MAX241E

±15kV ESD-Protected,
5V RS-232 Transceivers

high for the MAX205E/MAX206E/MAX211E/MAX241E (SHDN), but is active low for the MAX213E ($\overline{\text{SHDN}}$).

The MAX213E's receiver propagation delay is typically 0.5µs in normal operation. In shutdown mode, propagation delay increases to 4µs for both rising and falling transitions. The MAX213E's receiver inputs have approximately 0.5V hysteresis, except in shutdown, when receivers R4 and R5 have no hysteresis.

When entering shutdown with receivers active, R4 and R5 are not valid until 80µs after $\overline{\text{SHDN}}$ is driven low. When coming out of shutdown, all receiver outputs are invalid until the charge pumps reach nominal voltage levels (less than 2ms when using 0.1µF capacitors).

±15kV ESD Protection

As with all Maxim devices, ESD-protection structures are incorporated on all pins to protect against electro-static discharges encountered during handling and assembly. The driver outputs and receiver inputs have extra protection against static electricity. Maxim's engineers developed state-of-the-art structures to protect these pins against ESD of ±15kV without damage. The ESD structures withstand high ESD in all states: normal operation, shutdown, and powered down. After an ESD event, Maxim's E versions keep working without latchup, whereas competing RS-232 products can latch and must be powered down to remove latchup.

ESD protection can be tested in various ways; the transmitter outputs and receiver inputs of this product family are characterized for protection to the following limits:

- 1) ±15kV using the Human Body Model
- 2) ±8kV using the contact-discharge method specified in IEC1000-4-2
- 3) ±15kV using IEC1000-4-2's air-gap method.

ESD Test Conditions

ESD performance depends on a variety of conditions. Contact Maxim for a reliability report that documents test set-up, test methodology, and test results.

Human Body Model

Figure 6a shows the Human Body Model, and Figure 6b shows the current waveform it generates when discharged into a low impedance. This model consists of a 100pF capacitor charged to the ESD voltage of interest, which is then discharged into the test device through a 1.5kΩ resistor.



Figure 5. MAX211E V+ and V- when Exiting Shutdown (0.1µF capacitors)

**Table 1a. MAX205E/MAX206E/MAX211E/
MAX241E Control Pin Configurations**

SHDN	$\overline{\text{EN}}$	OPERATION STATUS	Tx	Rx
0	0	Normal Operation	All Active	All Active
0	1	Normal Operation	All Active	All High-Z
1	X	Shutdown	All High-Z	All High-Z

X = Don't care.

Table 1b. MAX213E Control Pin Configurations

$\overline{\text{SHDN}}$	EN	OPERATION STATUS	Tx 1–4	Rx	
				1–3	4, 5
0	0	Shutdown	All High-Z	High-Z	High-Z
0	1	Shutdown	All High-Z	High-Z	Active*
1	0	Normal Operation	All Active	High-Z	High-Z
1	1	Normal Operation	All Active	Active	Active

*Active = active with reduced performance



Figure 6a. Human Body ESD Test Model

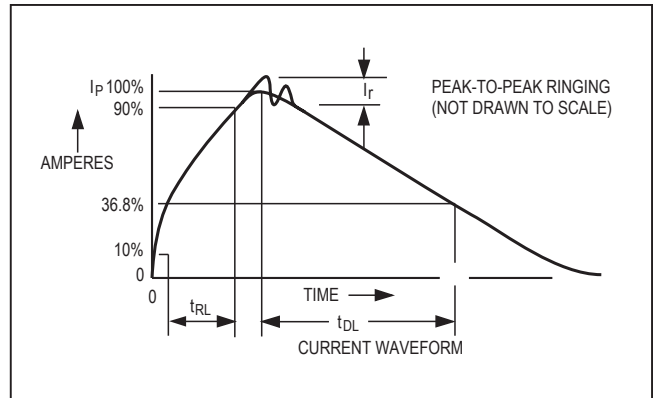

Figure 6b. Human Body Model Current Waveform



Figure 7a. IEC1000-4-2 ESD Test Model

IEC1000-4-2

The IEC1000-4-2 standard covers ESD testing and performance of finished equipment; it does not specifically refer to integrated circuits. The MAX202E/MAX203E–MAX213E, MAX232E/MAX241E help you design equipment that meets level 4 (the highest level) of IEC1000-4-2, without the need for additional ESD-protection components.

The major difference between tests done using the Human Body Model and IEC1000-4-2 is higher peak current in IEC1000-4-2, because series resistance is lower in the IEC1000-4-2 model. Hence, the ESD withstand voltage measured to IEC1000-4-2 is generally lower than that measured using the Human Body Model. Figure 7b shows the current waveform for the 8kV IEC1000-4-2 level-four ESD contact-discharge test.

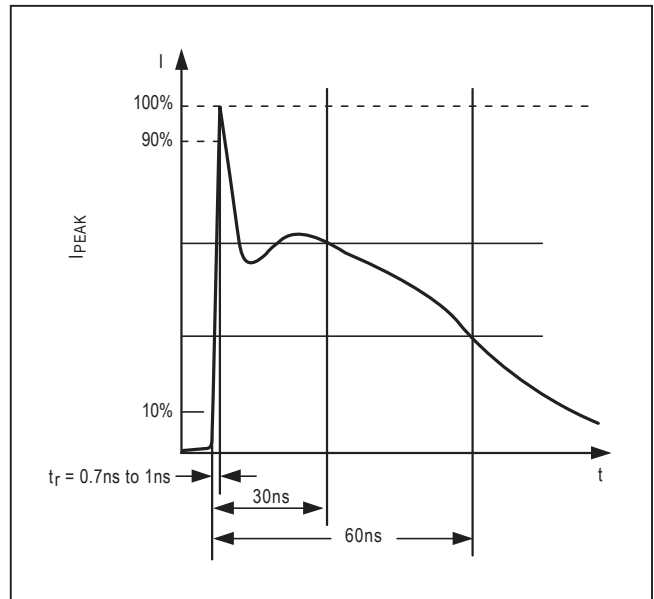

Figure 7b. IEC1000-4-2 ESD Generator Current Waveform

The air-gap test involves approaching the device with a charged probe. The contact-discharge method connects the probe to the device before the probe is energized.

Machine Model

The Machine Model for ESD tests all pins using a 200pF storage capacitor and zero discharge resistance. Its objective is to emulate the stress caused by contact that occurs with handling and assembly during manufacturing. Of course, all pins require this protection during manufacturing, not just RS-232 inputs and outputs. Therefore, after PC board assembly, the Machine Model is less relevant to I/O ports.

Applications Information

Capacitor Selection

The capacitor type used for C1–C4 is not critical for proper operation. The MAX202E, MAX206–MAX208E, MAX211E, and MAX213E require 0.1µF capacitors, and the MAX232E and MAX241E require 1µF capacitors, although in all cases capacitors up to 10µF can be used without harm. Ceramic, aluminum-electrolytic, or tantalum capacitors are suggested for the 1µF capacitors, and ceramic dielectrics are suggested for the 0.1µF capacitors. When using the minimum recommended capacitor values, make sure the capacitance value does not degrade excessively as the operating temperature varies. If in doubt, use capacitors with a larger (e.g., 2x) nominal value. The capacitors' effective series resistance (ESR), which usually rises at low temperatures, influences the amount of ripple on V+ and V-.

Use larger capacitors (up to 10µF) to reduce the output impedance at V+ and V-. This can be useful when “stealing” power from V+ or from V-. The MAX203E and MAX205E have internal charge-pump capacitors.

Bypass V_{CC} to ground with at least 0.1µF. In applications sensitive to power-supply noise generated by the charge pumps, decouple V_{CC} to ground with a capacitor the same size as (or larger than) the charge-pump capacitors (C1–C4).

V+ and V- as Power Supplies

A small amount of power can be drawn from V+ and V-, although this will reduce both driver output swing and noise margins. Increasing the value of the charge-pump capacitors (up to 10µF) helps maintain performance when power is drawn from V+ or V-.

Driving Multiple Receivers

Each transmitter is designed to drive a single receiver. Transmitters can be paralleled to drive multiple receivers.

Driver Outputs when Exiting Shutdown

The driver outputs display no ringing or undesirable transients as they come out of shutdown.

High Data Rates

These transceivers maintain the RS-232 ±5.0V minimum driver output voltages at data rates of over 120kbps. For data rates above 120kbps, refer to the Transmitter Output Voltage vs. Load Capacitance graphs in the *Typical Operating Characteristics*. Communication at these high rates is easier if the capacitive loads on the transmitters are small; i.e., short cables are best.

Table 2. Summary of EIA/TIA-232E, V.28 Specifications

PARAMETER		CONDITIONS	EIA/TIA-232E, V.28 SPECIFICATIONS
Driver Output Voltage	0 Level	3kΩ to 7kΩ load	+5V to +15V
	1 Level	3kΩ to 7kΩ load	-5V to -15V
Driver Output Level, Max		No load	±25V
Data Rate		3kΩ ≤ R _L ≤ 7kΩ, C _L ≤ 2500pF	Up to 20kbps
Receiver Input Voltage	0 Level		+3V to +15V
	1 Level		-3V to -15V
Receiver Input Level			±25V
Instantaneous Slew Rate, Max		3kΩ ≤ R _L ≤ 7kΩ, C _L ≤ 2500pF	30V/µs
Driver Output Short-Circuit Current, Max			100mA
Transition Rate on Driver Output		V.28	1ms or 3% of the period
		EIA/TIA-232E	4% of the period
Driver Output Resistance		-2V < V _{OUT} < +2V	300Ω

MAX202E–MAX213E, MAX232E/MAX241E

±15kV ESD-Protected,
5V RS-232 Transceivers

**Table 3. DB9 Cable Connections
Commonly Used for EIA/TIA-232E and
V.24 Asynchronous Interfaces**

PIN	EIA/TIA-232E, V.28 SPECIFICATIONS	
1	Received Line Signal Detector (sometimes called Carrier Detect, DCD)	Handshake from DCE
2	Receive Data (RD)	Data from DCE
3	Transmit Data (TD)	Data from DTE
4	Data Terminal Ready	Handshake from DTE
5	Signal Ground	Reference point for Signals
6	Data Set Ready (DSR)	Handshake from DCE
7	Request to Send (RTS)	Handshake from DTE
8	Clear to Send (CTS)	Handshake from DCE
9	Ring Indicator	Handshake from DCE

Pin Configurations and Typical Operating Circuits (continued)



**MAX202E-MAX213E,
MAX232E/MAX241E**

**±15kV ESD-Protected,
5V RS-232 Transceivers**

Pin Configurations and Typical Operating Circuits (continued)



Pin Configurations and Typical Operating Circuits (continued)



Pin Configurations and Typical Operating Circuits (continued)



**MAX202E-MAX213E,
MAX232E/MAX241E**

**±15kV ESD-Protected,
5V RS-232 Transceivers**

Pin Configurations and Typical Operating Circuits (continued)

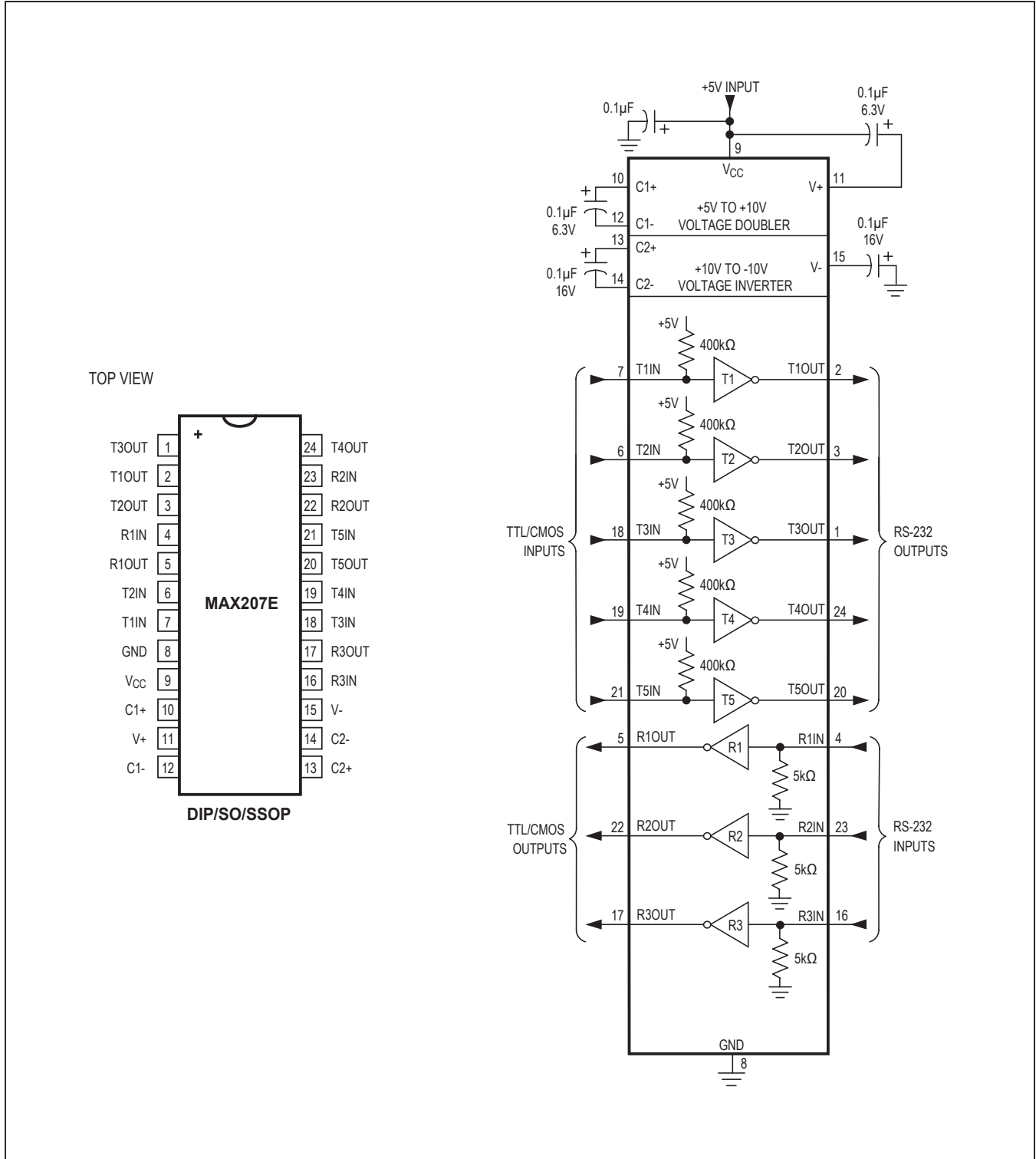

**MAX202E-MAX213E,
MAX232E/MAX241E**

**±15kV ESD-Protected,
5V RS-232 Transceivers**

Pin Configurations and Typical Operating Circuits (continued)

TOP VIEW



**MAX202E–MAX213E,
MAX232E/MAX241E**

**±15kV ESD-Protected,
5V RS-232 Transceivers**

Pin Configurations and Typical Operating Circuits (continued)

TOP VIEW



() ARE FOR MAX213E ONLY
* 1.0μF CAPACITORS, MAX241E ONLY

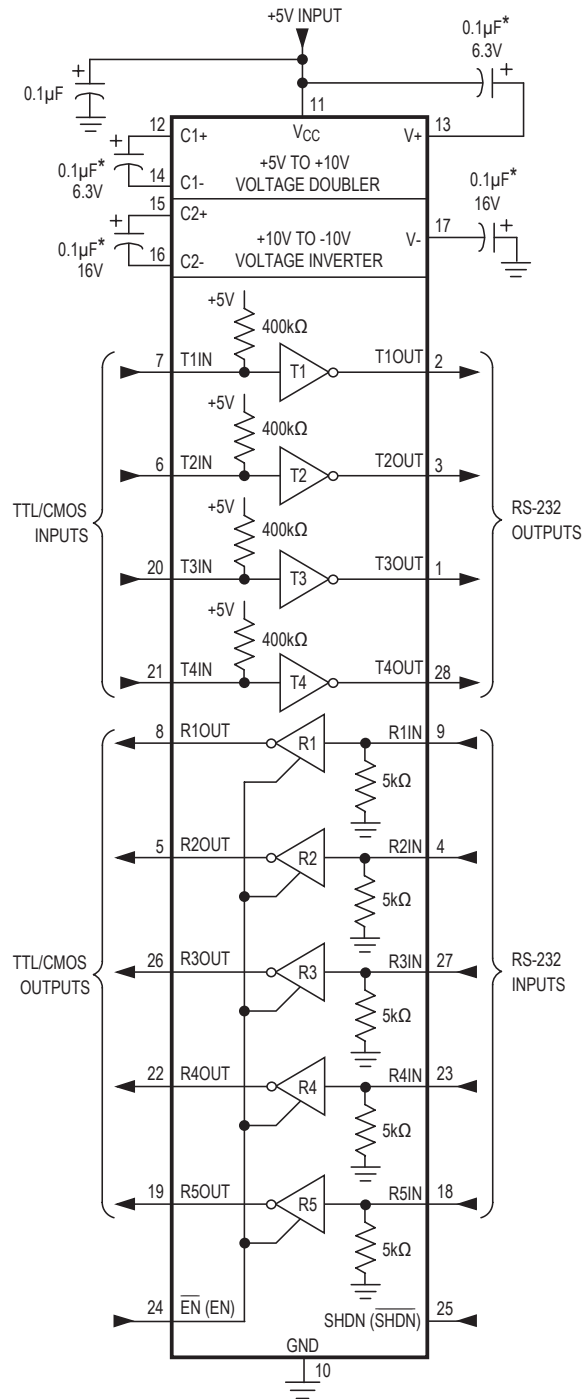

**MAX202E–MAX213E,
MAX232E/MAX241E**

**±15kV ESD-Protected,
5V RS-232 Transceivers**

Ordering Information (continued)

PART	TEMP RANGE	PIN-PACKAGE
MAX202ECUE	0°C to +70°C	16 TSSOP
MAX202ECWE	0°C to +70°C	16 Wide SO
MAX202EC/D	0°C to +70°C	Dice*
MAX202EEPE	-40°C to +85°C	16 Plastic DIP
MAX202EESE	-40°C to +85°C	16 Narrow SO
MAX202EEUE	-40°C to +85°C	16 TSSOP
MAX202EEWE	-40°C to +85°C	16 Wide SO
MAX203ECPP	0°C to +70°C	20 Plastic DIP
MAX203ECWP	0°C to +70°C	20 SO
MAX203EEPP	-40°C to +85°C	20 Plastic DIP
MAX203EEWP	-40°C to +85°C	20 SO
MAX205ECPG	0°C to +70°C	24 Wide Plastic DIP
MAX205EEPG	-40°C to +85°C	24 Wide Plastic DIP
MAX206ECNG	0°C to +70°C	24 Narrow Plastic DIP
MAX206ECWG	0°C to +70°C	24 SO
MAX206ECAG	0°C to +70°C	24 SSOP
MAX206EENG	-40°C to +85°C	24 Narrow Plastic DIP
MAX206EEWG	-40°C to +85°C	24 SO
MAX206EEAG	-40°C to +85°C	24 SSOP
MAX207ECNG	0°C to +70°C	24 Narrow Plastic DIP
MAX207ECWG	0°C to +70°C	24 SO
MAX207ECAG	0°C to +70°C	24 SSOP
MAX207EENG	-40°C to +85°C	24 Narrow Plastic DIP
MAX207EEWG	-40°C to +85°C	24 SO
MAX207EEAG	-40°C to +85°C	24 SSOP

PART	TEMP RANGE	PIN-PACKAGE
MAX208ECNG	0°C to +70°C	24 Narrow Plastic DIP
MAX208ECWG	0°C to +70°C	24 SO
MAX208ECAG	0°C to +70°C	24 SSOP
MAX208EENG	-40°C to +85°C	24 Narrow Plastic DIP
MAX208EEWG	-40°C to +85°C	24 SO
MAX208EEAG	-40°C to +85°C	24 SSOP
MAX211ECWI	0°C to +70°C	28 SO
MAX211ECAI	0°C to +70°C	28 SSOP
MAX211EEWI	-40°C to +85°C	28 SO
MAX211EEAI	-40°C to +85°C	28 SSOP
MAX213ECWI	0°C to +70°C	28 SO
MAX213ECAI	0°C to +70°C	28 SSOP
MAX213EEWI	-40°C to +85°C	28 SO
MAX213EEAI	-40°C to +85°C	28 SSOP
MAX232ECPE	0°C to +70°C	16 Plastic DIP
MAX232ECSE	0°C to +70°C	16 Narrow SO
MAX232ECWE	0°C to +70°C	16 Wide SO
MAX232EC/D	0°C to +70°C	Dice*
MAX232EEPE	-40°C to +85°C	16 Plastic DIP
MAX232EESE	-40°C to +85°C	16 Narrow SO
MAX232EEWE	-40°C to +85°C	16 Wide SO
MAX241ECWI	0°C to +70°C	28 SO
MAX241ECAI	0°C to +70°C	28 SSOP
MAX241EEWI	-40°C to +85°C	28 SO
MAX241EEAI	-40°C to +85°C	28 SSOP

*Dice are specified at $T_A = +25^\circ\text{C}$.

MAX202E-MAX213E, MAX232E/MAX241E

±15kV ESD-Protected,
5V RS-232 Transceivers

Package Information

For the latest package outline information and land patterns (footprints), go to www.maximintegrated.com/packages. Note that a "+", "#", or "-" in the package code indicates RoHS status only. Package drawings may show a different suffix character, but the drawing pertains to the package regardless of RoHS status.



MAX202E-MAX213E, MAX232E/MAX241E

±15kV ESD-Protected,
5V RS-232 Transceivers

Package Information (continued)

For the latest package outline information and land patterns (footprints), go to www.maximintegrated.com/packages. Note that a "+", "#", or "-" in the package code indicates RoHS status only. Package drawings may show a different suffix character, but the drawing pertains to the package regardless of RoHS status.

DIM	INCHES		MILLIMETERS	
	MIN	MAX	MIN	MAX
A	0.068	0.078	1.73	1.99
A1	0.002	0.008	0.05	0.21
b	0.010	0.015	0.25	0.38
c	0.004	0.008	0.09	0.20
D	SEE VARIATIONS			
E	0.205	0.212	5.20	5.38
e	0.0256	BSC	0.65	BSC
H	0.301	0.311	7.65	7.90
L	0.025	0.037	0.63	0.95
α	0°	8°	0°	8°

D	INCHES		MILLIMETERS		N	PKG CODE
	MIN	MAX	MIN	MAX		
D	0.239	0.249	6.07	6.33	16L	A16-2, A16-3
D	0.278	0.289	7.07	7.33	20L	A20-1, A20-2, A20-5
D	0.317	0.328	8.07	8.33	24L	A24-1, A24-2, A24-3
D	0.397	0.407	10.07	10.33	28L	A28-1, A28-2, A28-3, A28-4, A28M-2, A28M-3

NOTES:

1. ALL DIMENSIONS ARE IN MILLIMETERS UNLESS OTHERWISE SPECIFIED.
2. MATERIAL MUST COMPLY WITH BANNED AND RESTRICTED SUBSTANCES SPEC # 10-0131.
3. D & E DO NOT INCLUDE MOLD FLASH.
4. MOLD FLASH OR PROTRUSIONS NOT TO EXCEED .15 MM (.006").
5. MEETS JEDEC MO-150.
6. LEADS TO BE COPLANAR WITHIN 0.10 MM.
7. ALL DIMENSIONS APPLY TO BOTH LEADED (-) AND PbFREE (+) PKG. CODES.

-DRAWING NOT TO SCALE-

TITLE: PACKAGE OUTLINE, SSOP 5.3mm BODY			
APPROVAL	DOCUMENT CONTROL NO. 21-0056	REV. C	1/1

MAX202E-MAX213E, MAX232E/MAX241E

±15kV ESD-Protected,
5V RS-232 Transceivers

Package Information (continued)

For the latest package outline information and land patterns (footprints), go to www.maximintegrated.com/packages. Note that a "+", "#", or "-" in the package code indicates RoHS status only. Package drawings may show a different suffix character, but the drawing pertains to the package regardless of RoHS status.

COMMON DIMENSIONS

SYMBOL	INCHES		MM	
	MIN.	MAX.	MIN.	MAX.
A	.093	.104	2.35	2.65
A1	.004	.012	0.10	0.30
b	.014	.019	0.35	0.49
c	.009	.013	0.23	0.32
E	.291	.299	7.40	7.60
e	.050	BSC	1.27	BSC
H	.394	.419	10.00	10.65
L	.016	.050	0.40	1.27

VARIATION A

SYMBOL	INCHES		MM	
	MIN.	MAX.	MIN.	MAX.
D	.398	.413	10.10	10.50
N	16			
MS013	AA			
PKG. CODE	W16-1, W16-2, W16-3, W16-6, W16-7, W16-4F, W16-H2, W16WH2, W16M-3, W16M-6, W16M-9, W16M-10			

VARIATION B

SYMBOL	INCHES		MM	
	MIN.	MAX.	MIN.	MAX.
D	.447	.463	11.35	11.75
N	18			
MS013	AB			
PKG. CODE	W18-1, W18-2			

VARIATION C

SYMBOL	INCHES		MM	
	MIN.	MAX.	MIN.	MAX.
D	.496	.512	12.60	13.00
N	20			
MS013	AC			
PKG. CODE	W20-1, W20-2, W20-3, W20-H2, W20WH2, W20M-1, W20M-3			

VARIATION D

SYMBOL	INCHES		MM	
	MIN.	MAX.	MIN.	MAX.
D	.598	.614	15.20	15.60
N	24			
MS013	AD			
PKG. CODE	W24-1, W24-2, W24-3, W24-4, W24-6, W24-7, W24-10			

VARIATION E

SYMBOL	INCHES		MM	
	MIN.	MAX.	MIN.	MAX.
D	.697	.713	17.70	18.10
N	28			
MS013	AE			
PKG. CODE	W28-1, W28-2, W28-3, W28-5, W28-6, W28M-1, W28M-2, W28M-3			

NOTES:

- ALL DIMENSIONS ARE IN MILLIMETERS UNLESS OTHERWISE SPECIFIED.
- MATERIAL MUST COMPLY WITH BANNED AND RESTRICTED SUBSTANCES SPEC # 10-0131.
- DIMENSIONS D AND E DO NOT INCLUDE MOLD FLASH.
- MOLD FLASH OR PROTRUSIONS NOT TO EXCEED 0.15mm (.006").
- LEADS TO BE COPLANAR WITHIN 0.10mm (.004").
- MEETS JEDEC MS013.
- N = NUMBER OF PINS.
- ALL DIMENSIONS APPLY TO BOTH LEADED (-) AND PbFREE (+) PKG. CODES.

—DRAWING NOT TO SCALE—

TITLE:
PACKAGE OUTLINE,
SOIC .300"

APPROVAL	DOCUMENT CONTROL NO. 21-0042	REV. G	1/1
----------	---------------------------------	-----------	-----

MAX202E–MAX213E, MAX232E/MAX241E

±15kV ESD-Protected,
5V RS-232 Transceivers

Package Information (continued)

For the latest package outline information and land patterns (footprints), go to www.maximintegrated.com/packages. Note that a “+”, “#”, or “-” in the package code indicates RoHS status only. Package drawings may show a different suffix character, but the drawing pertains to the package regardless of RoHS status.

COMMON DIMENSIONS						
SYMBOL	INCHES			MM		
	MIN.	TYP.*	MAX.	MIN.	TYP.*	MAX.
A	.053	.061	.069	1.35	1.55	1.75
A1	.004	.007	.010	0.10	0.18	0.25
b	.014	.017	.019	0.35	0.42	0.49
c	.007	.009	.010	0.19	0.22	0.25
E	.150	.154	.157	3.80	3.90	4.00
e	.050 BSC			1.27 BSC		
H	.228	.236	.244	5.80	6.00	6.20
L	.016	.033	.050	0.40	0.84	1.27
α	0°	4°	8°	0°	4°	8°
h	0.01	0.015	0.019	0.25	0.38	0.5

* Typical value provided for reference only. This is not a specification.

VARIATION A						
SYMBOL	INCHES			MM		
	MIN.	TYP.*	MAX.	MIN.	TYP.*	MAX.
D	.189	.193	.197	4.80	4.90	5.00
N	8					
MS012	AA					
PKG. CODE	S8+2, S8+2C, S8+4, S8+5, S8+6F, S8+7F, S8+8F, S8+10F, S8+11F, S8+16F, S8+19F, S8+20, S8+21, S8MK+1, S8M+5, S8MS+22, S8+22, S8+23, S8MS+23, S8MS+24					

VARIATION B						
SYMBOL	INCHES			MM		
	MIN.	TYP.*	MAX.	MIN.	TYP.*	MAX.
D	.337	.341	.344	8.55	8.65	8.75
N	14					
MS012	AB					
PKG. CODE	S14+1, S14+1C, S14+4, S14+5, S14+6, S14M+4, S14M+5, S14M+6, S14M+7					

VARIATION C						
SYMBOL	INCHES			MM		
	MIN.	TYP.*	MAX.	MIN.	TYP.*	MAX.
D	.386	.390	.394	9.80	9.90	10.00
N	16					
MS012	AC					
PKG. CODE	S16+1, S16+1C, S16+3, S16+5, S16+6, S16+8, S16+7F, S16+9F, S16+10F, S16M+3, S16M+6, S16M+11, S16MS+12					

NOTES:

- ALL DIMENSIONS ARE IN MILLIMETERS UNLESS OTHERWISE SPECIFIED.
- MATERIAL MUST COMPLY WITH BANNED AND RESTRICTED SUBSTANCES SPEC # 10–0131.
- DIMENSIONS D AND E DO NOT INCLUDE MOLD PROTRUSION. ALLOWABLE MOLD PROTRUSION IS 0.15 MM (.006") PER SIDE.
- LEADS TO BE COPLANAR WITHIN 0.10mm (.004").
- MEETS JEDEC MS012
- ALL DIMENSIONS APPLY TO BOTH LEADED (-) AND PbFREE (+) PKG. CODES.

–DRAWING NOT TO SCALE–

maxim
integrated.

TITLE: PACKAGE OUTLINE, 8L, 14L, 16L SOIC .150 INCH			
APPROVAL KAI LIU	DOCUMENT CONTROL NO. 21-0041	REV. T	1/1



Revision History

REVISION NUMBER	REVISION DATE	DESCRIPTION	PAGES CHANGED
8	1/21	Updated <i>Package information</i>	25



Looking for pricing, stock, or lifecycle information?

Click below to explore more details on WIN SOURCE:

-  [View MAX208ECAG+T on WIN SOURCE](#)
-  [Maxim Integrated Information](#)

Optimize Your Supply Chain with WIN SOURCE Solutions

-  Global Sourcing Solution
-  Obsolete Management
-  Cost Control Management
-  Shortage Management
-  Alternative Solution
-  Excess Inventory Management