



**THE DATASHEET OF
HTSW-103-07-G-S**



DO NOT SCALE FROM THIS PRINT

HTSW-XXX-XX-XXX-X-XX-XX-XX

TABLE 2	
BODY SPECIFICATION	
ROW/OPTION	USE BODY
-S, -S-NA/-NE	HTSW-50-S-LCP
-S-RA/-S-RE	HTSW-50-SRA-LCP
-D, -D-NA/NE	HTSW-50-D-LCP
-D-RA	HTSW-50-DRA-LCP
-T, -T-NA/-NE	HTSW-50-T-LCP
-T-RA, -Q-RA	HTSW-50-TRA-LCP
-Q	HTSW-50-T-LCP

TERMINAL SPACE SPEC
 -1= .100 [2.54] (FILL EVERY POSITION)
 -2= .200 [5.08] (FILL EVERY OTHER POSITION STARTING WITH THE 1st AND ENDING WITH THE LAST POSITION IN BODY)

NUMBER OF POSITIONS PER ROW
 -1: -01 THRU -50
 "A"= NUMBER OF POS x .100[2.54]
 -2: -02 THRU -25
 "A"= (NUMBER OF POS x .200[5.08])-.100[2.54]

LEAD STYLE
 SEE TABLE 1, SHT 6

OPTION 3
 *-MW: METAL WASHER (STRAIGHT TAIL OPTION ONLY) (AVAILABLE ON 05, 06, 07, 08, 16, 17, 18, 22, 23,24, 25, 41 & 42 LEAD STYLES ONLY) (N/A WITH -LC OPTION. 20 POS MIN, 30 POS MAX. SEE FIG 6, SHT 5)

OPTION 2
 -POLARIZING SPECIFICATION
 XXX INDICATES POS TO BE OMITTED

OPTION 1
 -BLANK: STRAIGHT (SEE FIG 1, SHT 2)
 -RA: RIGHT ANGLE (SEE TABLE 3 & 4, FIG 5, SHT 4)
 -RE: EXTENDED RIGHT ANGLE (SEE TABLE 3 & 4, FIG 5, SHT 4) (SINGLE ROW ONLY)
 -NA: RA OPTION WITH STRAIGHT OPTION BODY (SEE TABLE 3 & 4, FIG 5, SHT 4)
 -NE: RE OPTION WITH STRAIGHT OPTION BODY (SEE TABLE 3 & 4, FIG 5, SHT 4)
 -LC: LOCKING CLIP (4 POS MINIMUM; ONLY AVAILABLE ON: LEAD STYLES -08 THRU -13 & -22, WITH ROW OPTIONS -S & -D; N/A WITH -MW, -RA OR -RE OPTIONS; SEE FIG 2, SHT 2)
 -LA: -RA OPTION WITH -LL OPTION (SEE SHT 3)
 -LL: LOCKING LEAD (SEE FIG 4, SHT 3) (N/A WITH -RE OR -NE OPTIONS) (N/A IN SINGLE ROW, 1 OR 2 POSITIONS)

ROW SPECIFICATION (SEE TABLE 2)
 -S: SINGLE
 -D: DOUBLE
 -T: TRIPLE
 -Q: TRIPLE ROW, FILL OUTER ROWS ONLY

PLATING SPECIFICATIONS
 -G: 10µ" GOLD IN CONTACT AREA, 3µ" GOLD ON TAIL
 -T: MATTE TIN CONTACT AND TAIL
 -S: 30µ" SELECTIVE GOLD IN CONTACT AREA, MATTE TIN ON TAIL
 -H: 30µ" HEAVY GOLD IN CONTACT AREA, 3µ" GOLD ON TAIL
 -L: 10µ" LIGHT SELECTIVE GOLD IN CONTACT AREA, MATTE TIN ON TAIL
 -F: 3µ" FLASH SELECTIVE GOLD IN CONTACT AREA, MATTE TIN ON TAIL
 -E: 50µ" EXTRA HEAVY GOLD IN CONTACT AREA, 3µ" GOLD ON TAIL (AVAILABLE ON LEAD STYLES -07, -08, -09 STRAIGHT AND -08-D-RA)
 -TL: TIN/LEAD (90/10 ±5%) CONTACT AND TAIL, (AVAILABLE ONLY ON LEAD STYLES -07, -08 & -09)
 -TM: MATTE TIN CONTACT AND TAIL
 -SM: 30µ" SELECTIVE GOLD IN CONTACT AREA, MATTE TIN ON TAIL
 -LM: 10µ" LIGHT SELECTIVE GOLD IN CONTACT AREA, MATTE TIN ON TAIL
 -FM: 3µ" FLASH SELECTIVE GOLD IN CONTACT AREA, MATTE TIN ON TAIL
 -STL: 30µ" SELECTIVE GOLD IN CONTACT AREA, TIN/LEAD (90/10 ±5%) TAIL
 -LTL: 10µ" LIGHT SELECTIVE GOLD IN CONTACT AREA, TIN/LEAD (90/10 +/-5%) TAIL, (AVAILABLE ONLY ON LEAD STYLE -15)
 -SS: 30µ" STRIPE SELECTIVE GOLD IN CONTACT AREA, MATTE TIN ON TAIL, (SEE NOTE 9)

*** - MW OPTION, DO NOT DESIGN IN. SAMTEC WILL ONLY SUPPORT EXISTING BUSINESS 2/12/02.**

CRITICAL DIMENSION INSPECTION INSTRUCTION TABLE	
ASSEMBLY OPERATION	IN-PROCESS INSPECTION
FILL	C1
MULTI-CUT	C2
RIGHT ANGLE	C4
RIGHT ANGLE	C5
RIGHT ANGLE	C6
CRIMP	C7
CPCs INTENTIONALLY DELETED:	C3

NOTES:

- ⊙ REPRESENTS CRITICAL DIMENSION FOR STATISTICAL PROCESS CONTROL.
- MINIMUM TERMINAL PUSHOUT FORCE: 3 LBS.
- MAXIMUM HEIGHT VARIATION: .005[.127] (N/A ON -RA TAIL).
- ASSEMBLE GOLD PLATE END AS SHOWN IN FIG 1.
- STYLE -26: ROUND END OF PIN TO APPEAR ON BOTTOM (SEE FIG 7, SHT 6).
- MINIMUM GOLD PLATED CONTACT AREA: .165[4.19] REF; PINS -18, -21 & -25: .050[1.27] REF.
- CRIMP TWO PINS CLOSEST TO CENTER OF THE PART IF THERE IS A POLARIZED POSITION IN THE MIDDLE/CENTER.
- MAXIMUM CUT FLASH: .010 [.25].
- SS PLATING OPTION ONLY AVAILABLE ON -07, -08, -09 STRAIGHT AND -08 -RA LEAD STYLES. MATES WITH SSQ, SSW, SSM, BCS, ESQ & ESW.
- MEASURE FROM THE BEND RADIUS OF THE TERMINALS.
- ORIENTATE PINS TO PREVENT BANDOLIER MARKS FROM SHOWING IN THE POST AREA. (SEE TABLE 6, SHT 7).

UNLESS OTHERWISE SPECIFIED, DIMENSIONS ARE IN INCHES. TOLERANCES ARE: DECIMALS ANGLES .XX: ±.01 [.25] 2° .XXX: ±.005 [.13] .XXXX: ±.0020 [.051]	PROPRIETARY NOTE THIS DOCUMENT CONTAINS CONFIDENTIAL AND PROPRIETARY INFORMATION AND ALL DESIGN, MANUFACTURING, REPRODUCTION, USE, PATENT RIGHTS AND SALES RIGHTS ARE EXPRESSLY RESERVED BY SAMTEC, INC. THIS DOCUMENT SHALL NOT BE DISCLOSED, IN WHOLE OR PART, TO ANY UNAUTHORIZED PERSON OR ENTITY NOR REPRODUCED, TRANSFERRED OR INCORPORATED IN ANY OTHER PROJECT IN ANY MANNER WITHOUT THE EXPRESS WRITTEN CONSENT OF SAMTEC, INC.	 520 PARK EAST BLVD, NEW ALBANY, IN 47150 PHONE: 812-944-6733 FAX: 812-948-5047 e-Mail: info@SAMTEC.com code 55322
MATERIAL: DO NOT SCALE DRAWING SHEET SCALE: 3.5:1 INSULATOR: LCP, UL-94-V-0 COLOR: NATURAL	DESCRIPTION: .025 SQ POST HI-TEMP TERMINAL STRIP ASSEMBLY DWG. NO. HTSW-XXX-XX-XXX-X-XX-XX-XX BY: PURVIS 02/17/87 SHEET 1 OF 7	

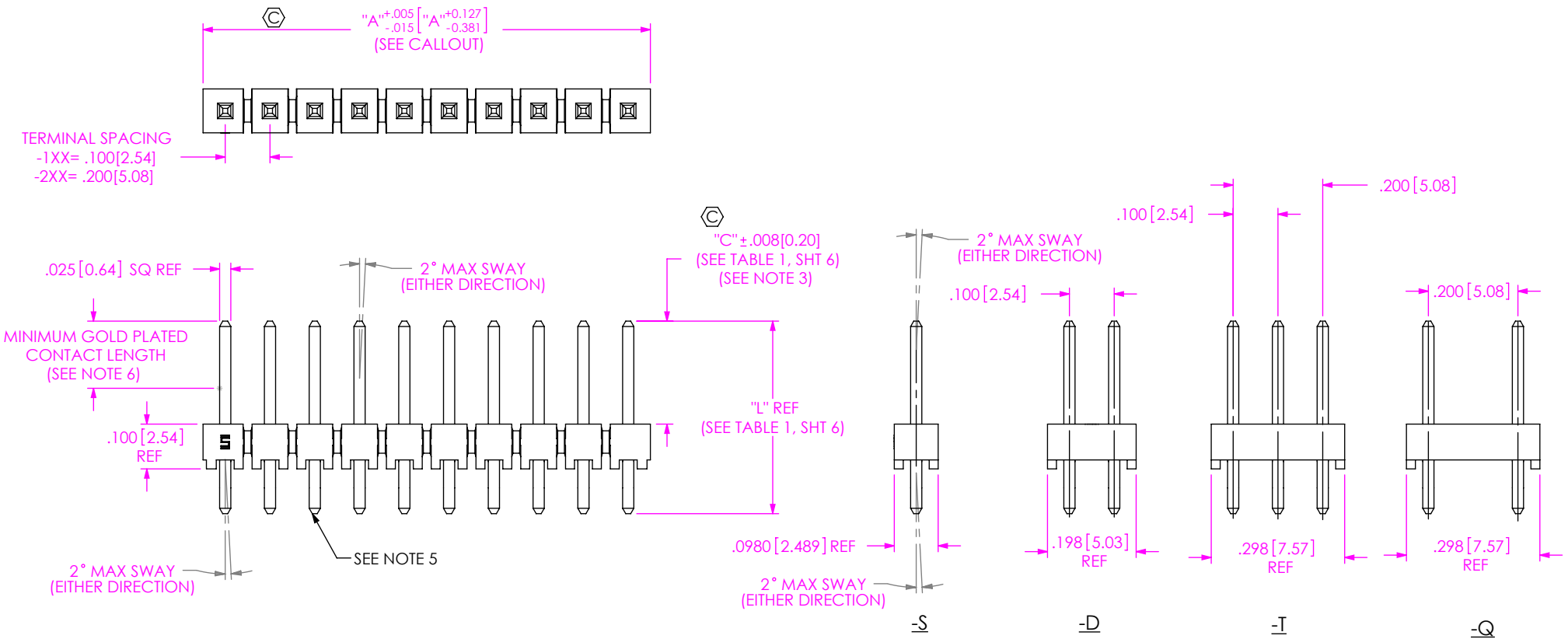

FIG 1
HTSW-110-07-XXX-D SHOWN

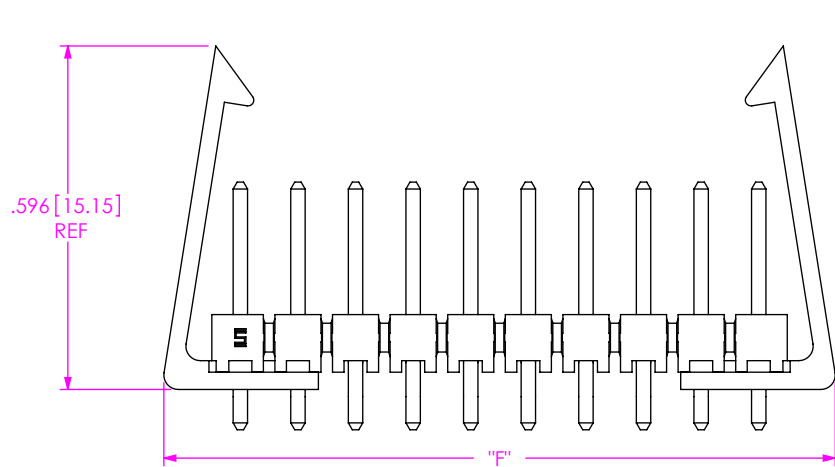

FIG 2: LOCKING CLIP
HTSW-110-07-XXX-D-LC SHOWN
(DIFFERENT AS SHOWN, OTHERWISE
SAME AS FIG 1)

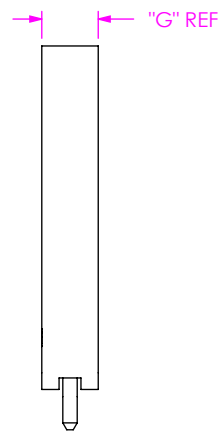

TABLE 5: -LC OPTION			
ROW	"F" $\pm .015$ [.38]	"G"	LATCH
-D	"A" $\pm .210$ [2.67]	.198[5.03]	LTC-02
-S	"A" $\pm .150$ [3.81]	.098[2.49]	LTC-01

F:\DWG\MISC\MKTG\HTSW-XXX-XX-XXX-X-XX-XX-MKT.SLDDRW

PROPRIETARY NOTE
THIS DOCUMENT CONTAINS CONFIDENTIAL AND PROPRIETARY INFORMATION AND ALL DESIGN, MANUFACTURING, REPRODUCTION, USE, PATENT RIGHTS AND SALES RIGHTS ARE EXPRESSLY RESERVED BY SAMTEC, INC. THIS DOCUMENT SHALL NOT BE DISCLOSED, IN WHOLE OR PART, TO ANY UNAUTHORIZED PERSON OR ENTITY NOR REPRODUCED, TRANSFERRED OR INCORPORATED IN ANY OTHER PROJECT IN ANY MANNER WITHOUT THE EXPRESS WRITTEN CONSENT OF SAMTEC, INC.

DO NOT SCALE DRAWING

SHEET SCALE: 3:1



520 PARK EAST BLVD, NEW ALBANY, IN 47150
PHONE: 812-944-6733 FAX: 812-948-5047
e-Mail info@SAMTEC.com code 55322

DESCRIPTION:
.025 SQ POST HI-TEMP TERMINAL STRIP ASSEMBLY

DWG. NO.
HTSW-XXX-XX-XXX-X-XX-XX-XX

BY: PURVIS 02/17/87 SHEET 2 OF 7

FIG 3
 TERMINAL SPACING
 (DIFFERENT AS SHOWN, OTHERWISE SAME AS FIG 1)

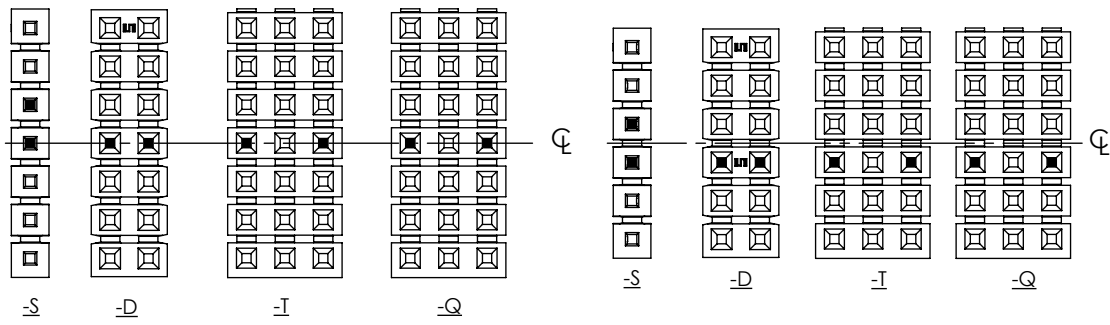
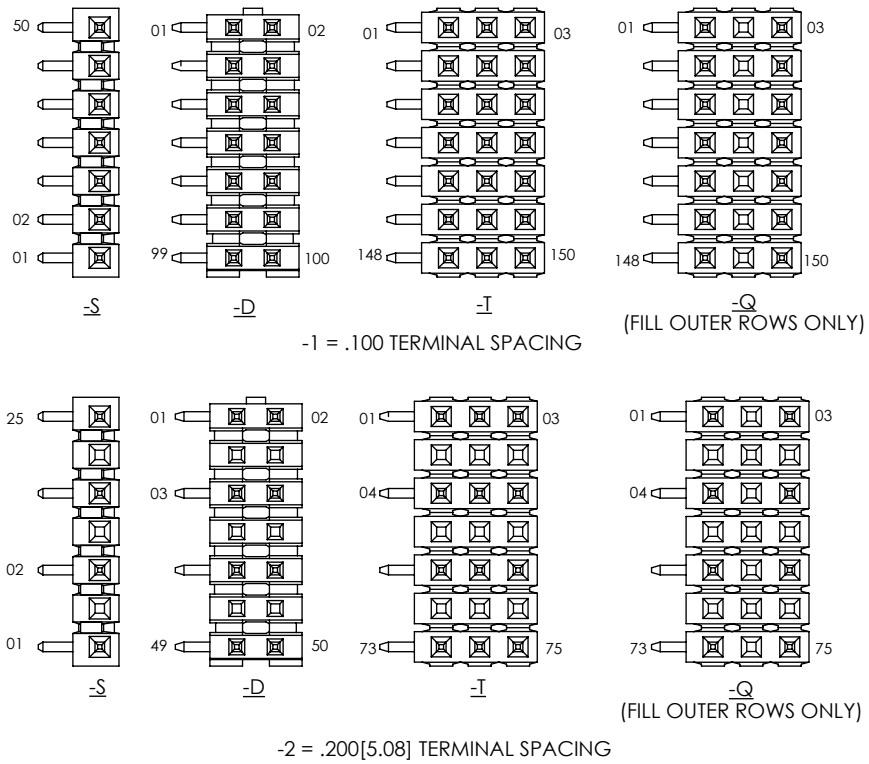

STRAIGHT VERSION
 ODD POSITIONS

STRAIGHT VERSION
 EVEN POSITIONS

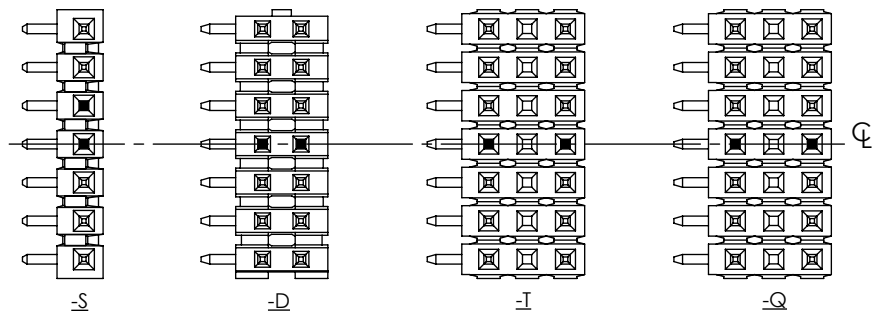

RIGHT ANGLE VERSION
 ODD POSITIONS

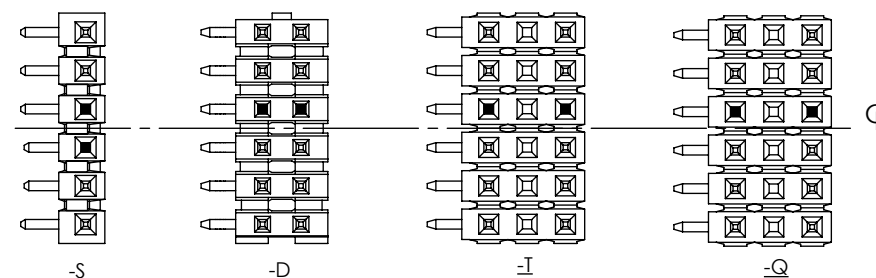

RIGHT ANGLE VERSION
 EVEN POSITIONS

-LL: LOCKING LEAD

■ = CRIMP LOCATION

TWO CENTER MOST PINS TO BE CRIMPED AS SHOWN.

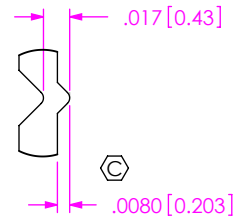
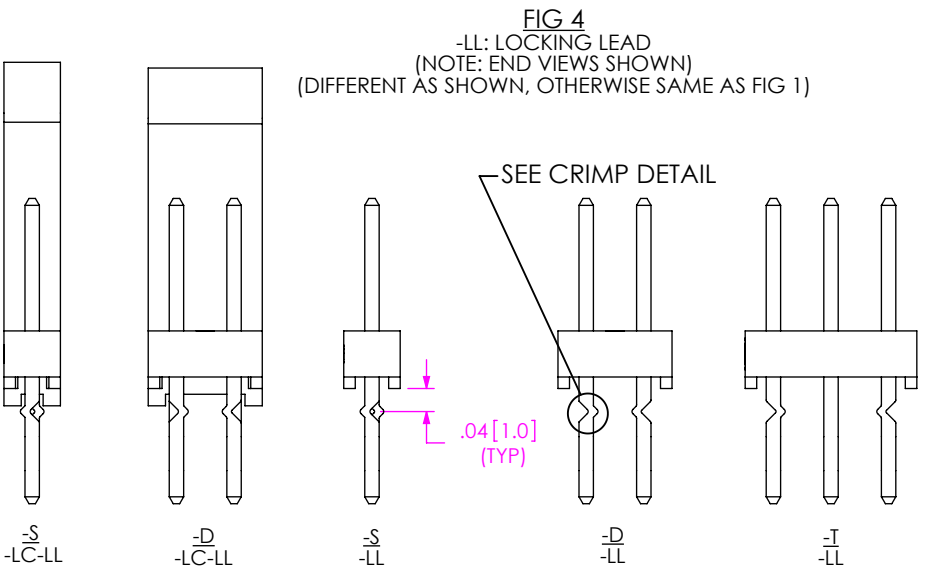

CRIMP DETAIL
 SCALE: 2X
 [TYP- ALL CRIMPS]

PROPRIETARY NOTE
 THIS DOCUMENT CONTAINS CONFIDENTIAL AND PROPRIETARY INFORMATION AND ALL DESIGN, MANUFACTURING, REPRODUCTION, USE, PATENT RIGHTS AND SALES RIGHTS ARE EXPRESSLY RESERVED BY SAMTEC, INC. THIS DOCUMENT SHALL NOT BE DISCLOSED, IN WHOLE OR PART, TO ANY UNAUTHORIZED PERSON OR ENTITY NOR REPRODUCED, TRANSFERRED OR INCORPORATED IN ANY OTHER PROJECT IN ANY MANNER WITHOUT THE EXPRESS WRITTEN CONSENT OF SAMTEC, INC.

DO NOT SCALE DRAWING
 SHEET SCALE: 3:1



DESCRIPTION:
 .025 SQ POST HI-TEMP TERMINAL STRIP ASSEMBLY
 DWG. NO.
HTSW-XXX-XX-XXX-X-XX-XX-XX
 BY: PURVIS 02/17/87 SHEET 3 OF 7

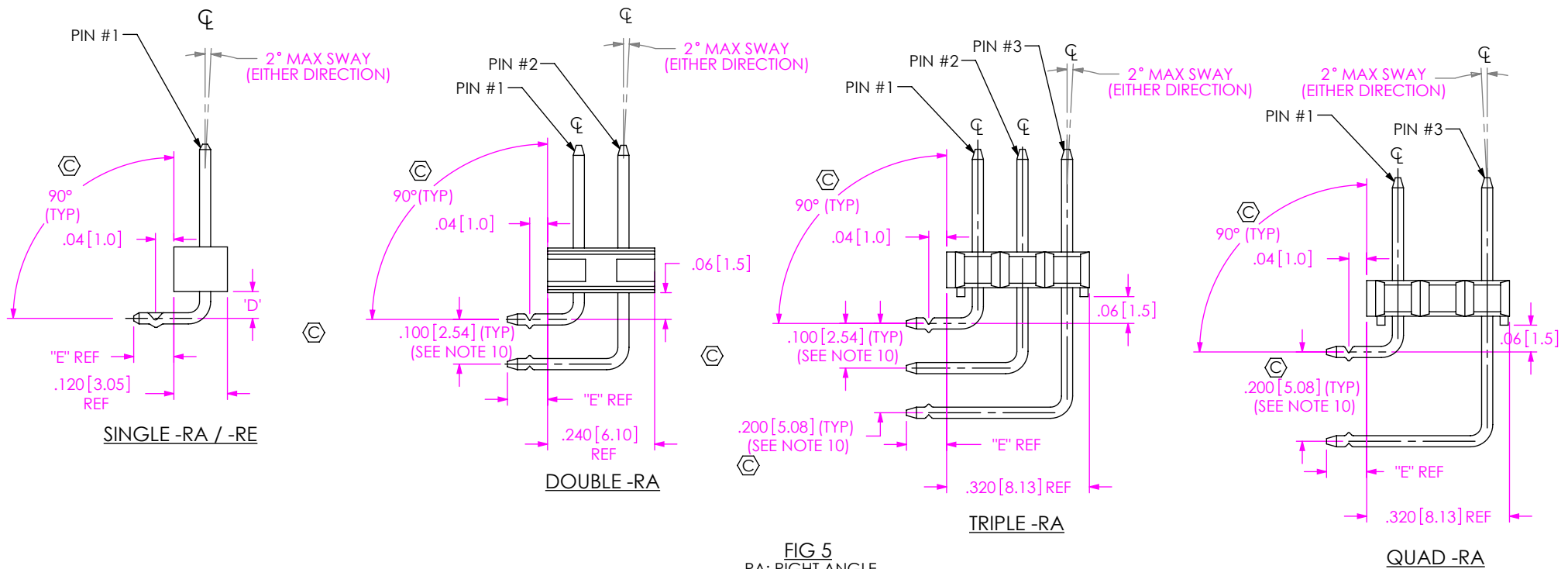

FIG 5
 -RA: RIGHT ANGLE
 (-LA OPTION IS SHOWN ON ALL -RA VIEWS FOR DIMENSIONAL PURPOSES)
 (SEE CRIMP DETAIL VIEW, SHT 3)
 (DIFFERENT AS SHOWN, OTHERWISE SAME AS FIG 1)

TABLE 4 - "E"

LEAD STYLE	RA SINGLE	RE SINGLE	RA DOUBLE	RA TRIPLE	NA SINGLE	NE SINGLE	NA DOUBLE	NA TRIPLE
08	.090 [2.29]	N/A	.090 [2.29]	.090 [2.29]	.109 [2.77]	N/A	.109 [2.77]	.109 [2.77]
09	.290 [7.37]	.190 [4.83]	.290 [7.37]	.290 [7.37]	.309 [7.85]	.209 [5.31]	.309 [7.85]	.309 [7.85]
10	.390 [9.91]	.290 [7.37]	.390 [9.91]	.390 [9.91]	.409 [10.39]	.309 [7.85]	.409 [10.39]	.409 [10.39]
11	.490 [12.45]	.390 [9.91]	.490 [12.45]	.490 [12.45]	.509 [12.93]	.409 [10.39]	.509 [12.93]	.509 [12.93]
12	.590 [14.99]	.490 [12.45]	.590 [14.99]	.590 [14.99]	.609 [15.47]	.509 [12.93]	.609 [15.47]	.609 [15.47]
13	.790 [20.07]	.690 [17.53]	.790 [20.07]	N/A	.809 [20.55]	.709 [18.01]	.809 [20.55]	N/A
16	.200 [5.08]	.100 [2.54]	.200 [5.08]	.200 [5.08]	.219 [5.56]	.119 [3.02]	.219 [5.56]	.219 [5.56]
21	.990 [25.15]	.890 [22.61]	N/A	N/A	1.009 [25.63]	.909 [23.09]	N/A	N/A
22	.190 [4.83]	.090 [2.29]	.190 [4.83]	.190 [4.83]	.209 [5.31]	.109 [2.77]	.209 [5.31]	.209 [5.31]
25	.100 [2.54]	N/A	.100 [2.54]	.100 [2.54]	.119 [3.02]	N/A	.119 [3.02]	.119 [3.02]
27	.890 [22.61]	.790 [20.07]	N/A	N/A	.909 [23.09]	.809 [20.55]	N/A	N/A
28	.690 [17.53]	.590 [14.99]	.690 [17.53]	N/A	.709 [18.01]	.609 [15.47]	.709 [18.01]	N/A
29	.800 [20.32]	N/A	N/A	N/A	.819 [20.80]	N/A	N/A	N/A
30	.600 [15.24]	N/A	.600 [15.24]	N/A	.619 [15.72]	N/A	.619 [15.72]	N/A

TABLE 3	
-XX	"D"
-RA / -NA	.06 [1.5]
-RE / -NE	.16 [4.1]

PROPRIETARY NOTE
 THIS DOCUMENT CONTAINS CONFIDENTIAL AND PROPRIETARY INFORMATION AND ALL DESIGN, MANUFACTURING, REPRODUCTION, USE, PATENT RIGHTS AND SALES RIGHTS ARE EXPRESSLY RESERVED BY SAMTEC, INC. THIS DOCUMENT SHALL NOT BE DISCLOSED, IN WHOLE OR PART, TO ANY UNAUTHORIZED PERSON OR ENTITY NOR REPRODUCED, TRANSFERRED OR INCORPORATED IN ANY OTHER PROJECT IN ANY MANNER WITHOUT THE EXPRESS WRITTEN CONSENT OF SAMTEC, INC.

DO NOT SCALE DRAWING

SHEET SCALE: 4:1



520 PARK EAST BLVD, NEW ALBANY, IN 47150
 PHONE: 812-944-6733 FAX: 812-948-5047
 e-Mail info@SAMTEC.com code 55322

DESCRIPTION:
 .025 SQ POST HI-TEMP TERMINAL STRIP ASSEMBLY

DWG. NO.
HTSW-XXX-XX-XXX-X-XX-XX-XX

BY: PURVIS 02/17/87 SHEET 4 OF 7

- MW OPTION, DO NOT DESIGN IN. SAMTEC WILL ONLY SUPPORT EXISTING BUSINESS 2/12/02.

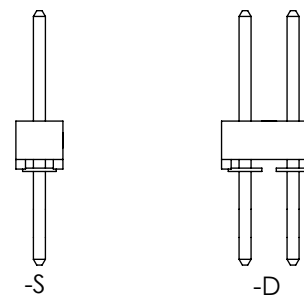
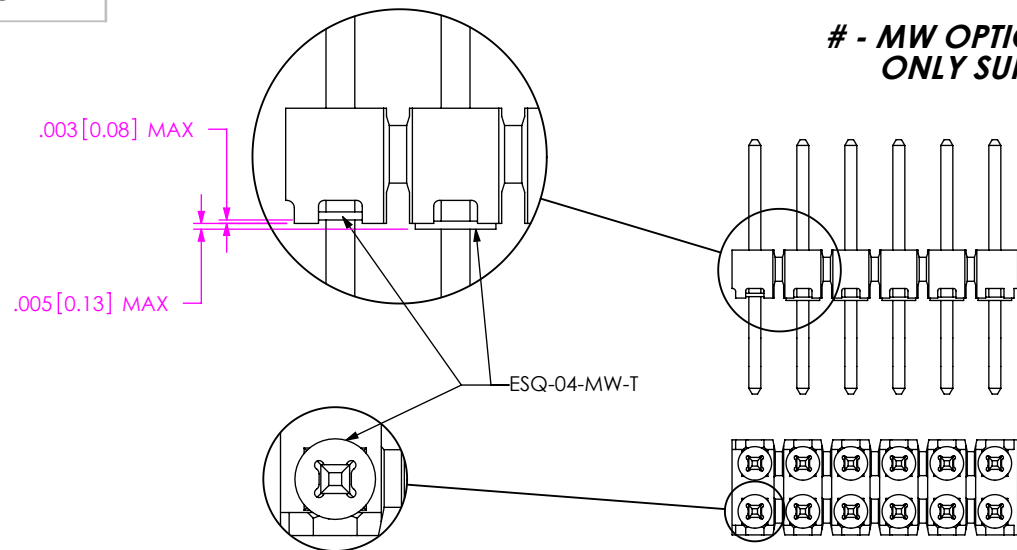
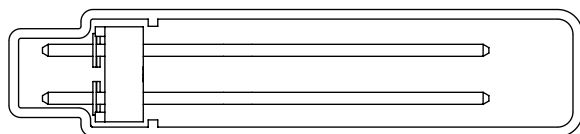
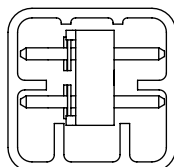

FIG 6
*-MW: METAL WASHER
(ONE PER POSITION)

-MW OPTION TUBE TABLE			
STYLE	ROW	TUBE	PLUG
-XX	-S	PT-1-24-02-04	TP-24
-08 -16 -22 -25	-D	PT-1-24-03-29	TP-07
-05 -17 -18 -23 -24 -41 -42	-D	PT-1-24-08-03	TP-03
-06	-D	PT-1-24-01-63	TP-24-02
-07	-D	PT-1-24-01-22	TP-03
-XX	-T/-Q	PT-1-24-07-51	TP-07



PT-1-24-08-03



PT-1-24-01-63

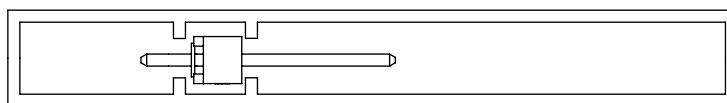

PT-1-24-02-04

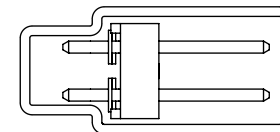

PT-1-24-01-22

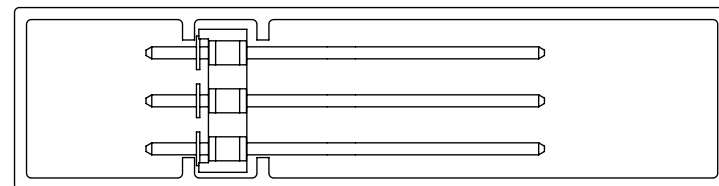

PT-1-24-07-51

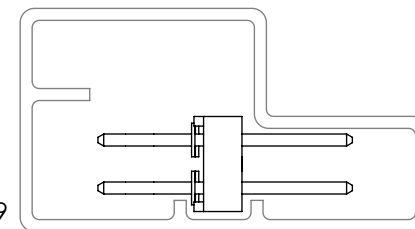

PT-1-24-03-29

PROPRIETARY NOTE
THIS DOCUMENT CONTAINS CONFIDENTIAL AND PROPRIETARY INFORMATION AND ALL DESIGN, MANUFACTURING, REPRODUCTION, USE, PATENT RIGHTS AND SALES RIGHTS ARE EXPRESSLY RESERVED BY SAMTEC, INC. THIS DOCUMENT SHALL NOT BE DISCLOSED, IN WHOLE OR PART, TO ANY UNAUTHORIZED PERSON OR ENTITY NOR REPRODUCED, TRANSFERRED OR INCORPORATED IN ANY OTHER PROJECT IN ANY MANNER WITHOUT THE EXPRESS WRITTEN CONSENT OF SAMTEC, INC.

DO NOT SCALE DRAWING

SHEET SCALE: 2.5:1

samtec

520 PARK EAST BLVD, NEW ALBANY, IN 47150
PHONE: 812-944-6733 FAX: 812-948-5047
e-Mail info@SAMTEC.com code 55322

DESCRIPTION:
.025 SQ POST HI-TEMP TERMINAL STRIP ASSEMBLY

DWG. NO.
HTSW-XXX-XX-XXX-X-XX-XX-XX

BY: PURVIS 02/17/87 SHEET 5 OF 7

TABLE 1
TERMINAL SPECIFICATIONS

TERMINAL SPEC	PIN #1	"L"	PIN #2 (2)	PIN #3	"C"
-05 (3)	T-1S6-21-XXX-2	.335 [8.51]	N/A	N/A	.105 [2.67] (5)
-06 (3)	T-1S6-18-XXX-2	.300 [7.62]	N/A	N/A	.105 [2.67] (5)
-07 (3)	T-1S6-07-XXX-2	.430 [10.92]	N/A	N/A	.230 [5.84] (5)
-08 (4)	T-1S6-08-XXX-2	.530 [13.46]	T-1S6-09-XXX-2	T-1S6-11-XXX-2	.230 [5.84] (5) (6) (7)
-09	T-1S6-09-XXX-2	.730 [18.54]	T-1S6-11-XXX-2	T-1S6-20-XXX-2	.230 [5.84] (6)
-10	T-1S6-10-XXX-2	.830 [21.08]	T-1S6-12-XXX-2	T-1S6-13-XXX-2	.230 [5.84]
-11	T-1S6-11-XXX-2	.930 [23.62]	T-1S6-20-XXX-2	T-1S6-19-XXX-2	.230 [5.84]
-12	T-1S6-12-XXX-2	1.030 [26.16]	T-1S6-13-XXX-2	T-1S6-14-XXX-2	.230 [5.84]
-13	T-1S6-13-XXX-2	1.230 [31.24]	T-1S6-14-XXX-2	N/A	.230 [5.84]
-14 (3)	T-1S6-08-XXX-2	.530 [13.46]	N/A	N/A	.320 [8.13] (5)
-15 (3)	T-1S6-09-XXX-2	.730 [18.54]	N/A	N/A	.520 [13.21] (5)
-16	T-1S6-09-XXX-2	.730 [18.54]	T-1S6-11-XXX-2	T-1S6-20-XXX-2	.320 [8.13] (5) (6)
-17 (3)	T-1S6-10-XXX-2	.830 [21.08]	N/A	N/A	.620 [15.75] (5)
-18 (3)	T-1S6-11-XXX-2	.930 [23.62]	N/A	N/A	.720 [18.29] (5)
-19 (3)	T-1S6-12-XXX-2	1.030 [26.16]	N/A	N/A	.820 [20.83] (5)
-20 (3)	T-1S6-13-XXX-2	1.230 [31.24]	N/A	N/A	1.020 [25.91] (5)
-21	T-1S6-14-XXX-2	1.430 [36.32]	N/A	N/A	1.220 [30.99] (5)
-21 (1)	T-1S6-14-XXX-2	1.430 [36.32]	N/A	N/A	.230 [5.84]
-22	T-1S6-15-XXX-2	.630 [16.00]	T-1S6-10-XXX-2	T-1S6-12-XXX-2	.230 [5.84] (5) (6)
-23 (3)	T-1S6-16-XXX-2	.445 [11.30]	N/A	N/A	.230 [5.84] (5)
-24 (3)	T-1S6-17-XXX-2	.480 [12.19]	N/A	N/A	.265 [6.73] (5)
-25 (4)	T-1S6-15-XXX-2	.630 [16.00]	T-1S6-10-XXX-2	T-1S6-12-XXX-2	.320 [8.13] (5) (6)
*-26 (3)	T-1RS7-01-XXX-2	.456 [11.58]	N/A	N/A	.230 [5.84]
-27	T-1S6-19-XXX-2	1.330 [33.78]	N/A	N/A	.230 [5.84]
-28	T-1S6-20-XXX-2	1.130 [28.70]	T-1S6-19-XXX-2	N/A	.230 [5.84]
-29 (4)	T-1S6-19-XXX-2	1.330 [33.78]	N/A	N/A	.320 [8.13]
-30 (4)	T-1S6-20-XXX-2	1.130 [28.70]	T-1S6-19-XXX-2	N/A	.320 [8.13]
-41	T-1S6-25-XXX-2	.365 [9.27]	N/A	N/A	.230 [5.84]
-42	T-1S6-26-XXX-2	.470 [11.94]	N/A	N/A	.320 [8.13]

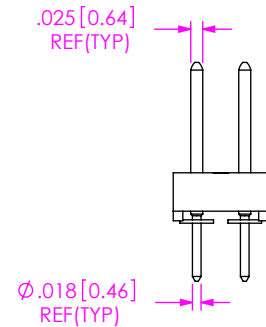

FIG 7
-26 LEAD STYLE
(SAME AS FIG 1, DIFFERENT AS SHOWN)

- (1) WITH -RA or -RE OPTION
 - (2) OMIT WITH -Q ROW SPECIFICATION
 - (3) NOT AVAILABLE IN -RA OR -RE OPTION.
 - (4) NOT AVAILABLE IN -RE OPTION.
 - (5) AVAILABLE IN -LL OPTION.
 - (6) AVAILABLE IN -LA OPTION.
 - (7) ON STYLE -08 -RA & -LA OPTIONS ONLY; 'C' = .230+.005/-.008 [5.84+.13/-.20]
- *SQUARE END OF PIN(T-1RS7-01-XXX-2)SHOULD BE LOCATED AT "C" DIMENSION DURING FILL PROCESS.
(SEE FIG 7)

PROPRIETARY NOTE
THIS DOCUMENT CONTAINS CONFIDENTIAL AND PROPRIETARY INFORMATION AND ALL DESIGN, MANUFACTURING, REPRODUCTION, USE, PATENT RIGHTS AND SALES RIGHTS ARE EXPRESSLY RESERVED BY SAMTEC, INC. THIS DOCUMENT SHALL NOT BE DISCLOSED, IN WHOLE OR PART, TO ANY UNAUTHORIZED PERSON OR ENTITY NOR REPRODUCED, TRANSFERRED OR INCORPORATED IN ANY OTHER PROJECT IN ANY MANNER WITHOUT THE EXPRESS WRITTEN CONSENT OF SAMTEC, INC.

DO NOT SCALE DRAWING

SHEET SCALE: 3.5:1



520 PARK EAST BLVD, NEW ALBANY, IN 47150
PHONE: 812-944-6733 FAX: 812-948-5047
e-Mail info@SAMTEC.com code 55322

DESCRIPTION:
.025 SQ POST HI-TEMP TERMINAL STRIP ASSEMBLY

DWG. NO.
HTSW-XXX-XX-XXX-X-XX-XX-XX

BY: PURVIS 02/17/87 SHEET 6 OF 7

TABLE 6 (-T PLATING ONLY)

LEAD STYLE	NUMBER OF BAND MARKS ALLOWED IN POST AREA			LEAD STYLE	NUMBER OF BAND MARKS ALLOWED IN POST AREA		
	PIN #1	PIN #2	PIN #3		PIN #1	PIN #2	PIN #3
*-05	*0	N/A	N/A	*-17	2	N/A	N/A
-06	1	N/A	N/A	*-18	2	N/A	N/A
-07	1	N/A	N/A	*-19	2	N/A	N/A
-08	0	0	0	*-20	2	N/A	N/A
-08 RA	0	0	0	*-21	2	N/A	N/A
-09	0	0	0	-21-RA	0	N/A	N/A
-09 RA	0	0	0	-21-RE	0	N/A	N/A
-09-RE	0	0	0	-22	0	0	0
-10	0	0	0	-22-RA	0	0	0
-10-RA	0	0	0	-22-RE	0	0	0
-10-RE	0	0	0	-23	1	N/A	N/A
-11	0	0	0	-24	1	N/A	N/A
-11-RA	0	0	0	-25	1	1	1
-11-RE	0	0	0	*-25-RA	1	0	0
-12	0	0	0	*-26	1	N/A	N/A
-12-RA	0	0	0	*-27	0	N/A	N/A
-12-RE	0	0	0	*-27-RA	0	N/A	N/A
-13	0	0	N/A	*-27-RE	0	N/A	N/A
-13-RA	0	0	N/A	*-28	0	0	N/A
-13-RE	0	0	N/A	*-28-RA	0	0	N/A
-14	1	N/A	N/A	*-28-RE	0	0	N/A
*-15	2	N/A	N/A	*-29	1	N/A	N/A
*-16	1	1	1	*-29-RA	1	N/A	N/A
*-16-RA	1	1	1	*-30	1	1	N/A
*-16-RE	1	1	1	*-30-RA	1	1	N/A

* PINS TO BE FLIPPED OPPOSITE OF SELECTIVE PLATING BEFORE BEING INSERTED

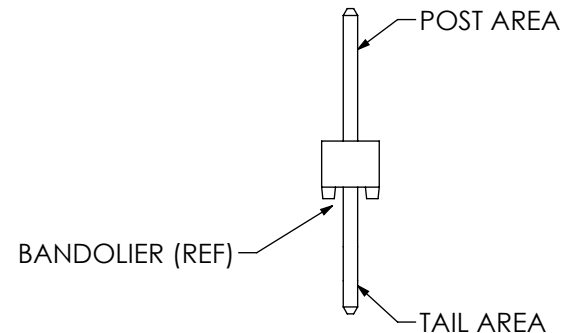

IN PROCESS 1
(SAME AS FIG. 1, DIFFERENT AS SHOWN)
-T PLATING ONLY

• PROPRIETARY NOTE •
THIS DOCUMENT CONTAINS CONFIDENTIAL AND PROPRIETARY INFORMATION AND ALL DESIGN, MANUFACTURING, REPRODUCTION, USE, PATENT RIGHTS AND SALES RIGHTS ARE EXPRESSLY RESERVED BY SAMTEC, INC. THIS DOCUMENT SHALL NOT BE DISCLOSED, IN WHOLE OR PART, TO ANY UNAUTHORIZED PERSON OR ENTITY NOR REPRODUCED, TRANSFERRED OR INCORPORATED IN ANY OTHER PROJECT IN ANY MANNER WITHOUT THE EXPRESS WRITTEN CONSENT OF SAMTEC, INC.

DO NOT SCALE DRAWING

SHEET SCALE: 3:1



520 PARK EAST BLVD, NEW ALBANY, IN 47150
PHONE: 812-944-6733 FAX: 812-948-5047
e-Mail info@SAMTEC.com code 55322

DESCRIPTION:
.025 SQ POST HI-TEMP TERMINAL STRIP ASSEMBLY

DWG. NO.
HTSW-XXX-XX-XXX-X-XX-XX-XX

BY: PURVIS 02/17/87 SHEET 7 OF 7

Looking for pricing, stock, or lifecycle information?

Click below to explore more details on WIN SOURCE:

 [View HTSW-103-07-G-S on WIN SOURCE](#)

 [Samtec Inc. Information](#)

Optimize Your Supply Chain with WIN SOURCE Solutions

-  Global Sourcing Solution
-  Obsolete Management
-  Cost Control Management
-  Shortage Management
-  Alternative Solution
-  Excess Inventory Management