



**THE DATASHEET OF
TCLAMP1202P.TGT**



PROTECTION PRODUCTS

Description

TClamp®1202P provides dedicated surge and ESD protection for RS-485 and other 12V lines in industrial applications. It features high surge current capability of 100A ($t_p=8/20\mu s$) and low clamping voltage making them ideal for use in harsh transient environments.

This device is designed to replace multiple discrete components by integrating low capacitance, surgerated compensation diodes with a high power transient voltage suppressor (TVS). Capacitance is limited to 12pF maximum to ensure correct signal transmission on high-speed lines. Each TClamp1202P may be used to protect up to two lines. A voltage bus operating up to 12V can also be optionally protected.

The TClamp1202P is in a 5-pin SLP2020P5 package, measuring 2.0 x 2.0mm with a nominal height of 0.60mm. The flow-through package design simplifies PCB layout.

Features

- Transient protection for high-speed data lines to **IEC 61000-4-2 (ESD) 20kV (air), 15kV (contact)**
- **IEC 61000-4-4 (EFT) 40A (5/50ns)**
- **IEC 61000-4-5 (Lightning) 100A (8/20 μs)**
- Array of surge rated diodes with internal TVS Diode
- Protects up to two lines
- Low capacitance: (<12pF)
- Operating voltage: 12V
- Low leakage current
- Solid-state silicon-avalanche technology

Mechanical Characteristics

- SLP2020P5 Package
- Pb-Free, Halogen Free, RoHS/WEEE Compliant
- Lead Finish: NiPdAu
- Molding Compound Flammability Rating: UL 94V-0
- Marking : Marking code + Date Code
- Packaging : Tape and Reel

Applications

- RS-485 Surge Protection
- RS-422 Surge Protection
- Industrial Equipment
- Remote Meter Readers
- Automatic Teller Machines
- Digital Surveillance Cameras
- CAN-bus

Functional Circuit Diagram

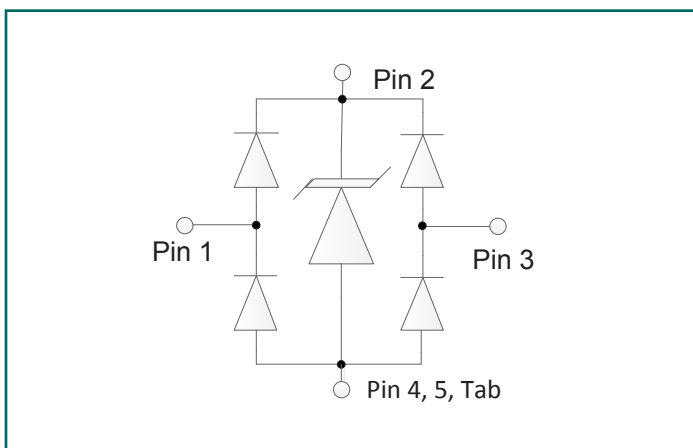

Package Configuration

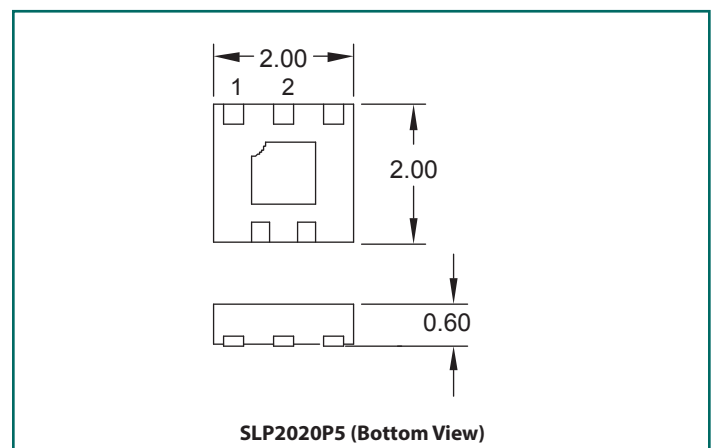

Absolute Maximum Rating

Rating	Symbol	Value	Units
Peak Pulse Power ($t_p = 10/1000\mu s$), $T=25^\circ C$	P_{PK}	300	W
Peak Pulse Current ($t_p = 10/1000\mu s$), $T=25^\circ C$	I_{PP}	12	A
Peak Pulse Current ($t_p = 8/20\mu s$), $T=25^\circ C$	I_{PP}	100	A
ESD per IEC 61000-4-2 (Air) ⁽²⁾ ESD per IEC 61000-4-2 (Contact) ⁽²⁾	V_{ESD}	± 20 ± 15	kV
Operating Temperature	T_J	-55 to +125	$^\circ C$
Storage Temperature	T_{STG}	-55 to +150	$^\circ C$

Electrical Characteristics (T=25°C unless otherwise specified)

Parameter	Symbol	Conditions	Min.	Typ.	Max.	Units
Reverse Stand-Off Voltage	V_{RWM}				12	V
Reverse Breakdown Voltage	V_{BR}	$I_t = 1mA$ Pins 1, 2 or 3 to Pins 4, 5 and Tab ⁴	13.3	15	18.5	V
Reverse Leakage Current	I_R	$V_{RWM} = 12V$ Pins 1, 2 or 3 to Pins 4, 5 and Tab ⁴	$T = 25^\circ C$		0.1	μA
			$T = 125^\circ C$		0.5	
Clamping Voltage	V_C	$t_p = 10/1000\mu s$ Pins 1, 2 or 3 to Pins 4, 5 and Tab ⁴			25	V
Clamping Voltage	V_C	$t_p = 8/20\mu s$ Pins 1, 2 or 3 to Pins 4, 5 and Tab ⁴			40	V
Dynamic Resistance ^{2,3}	R_{DYN}	$t_p = 0.2/100ns$ Pin 1 and 4		0.11		Ω
Junction Capacitance	C_J	$V_R = 0V, f = 1MHz$ Pins 1 or 3 to Pins 4, 5 and Tab ⁴			12	pF

Notes

- 1) Measured with a 40dB attenuator, 50 Ohm scope input impedance, 2GHz bandwidth. ESD gun return path connected to ESD ground plane.
- 2) Transmission Line Pulse Test (TLP) Settings: $t_p = 100ns$, $t_r = 0.2ns$, I_{TLP} and V_{TLP} averaging window: $t_1 = 70ns$ to $t_2 = 90ns$.
- 3) Dynamic resistance calculated from $I_{TLP} = 4A$ to $I_{TLP} = 16A$
- 4) Pin 4, 5 and center tab are internally connected.

Typical Characteristics

Non-Repetitive Peak Pulse Power vs. Pulse Time (VBus Pin1)

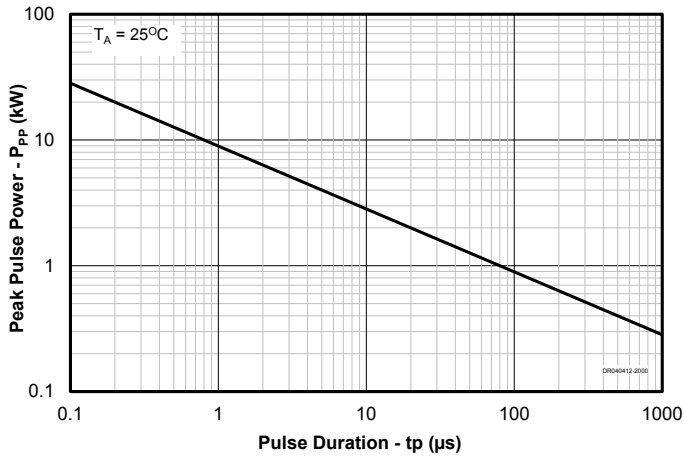

Capacitance vs. Reverse Voltage (Data Line Pins 1 and 3)

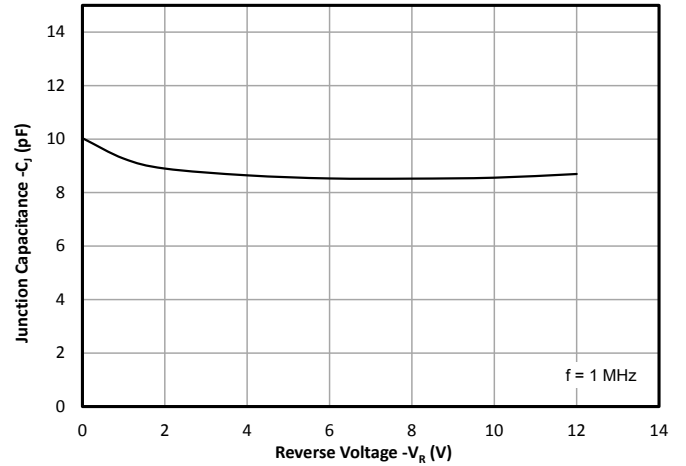

Clamping Voltage vs. Peak Pulse Current ($t_p = 10/1000\mu\text{s}$)

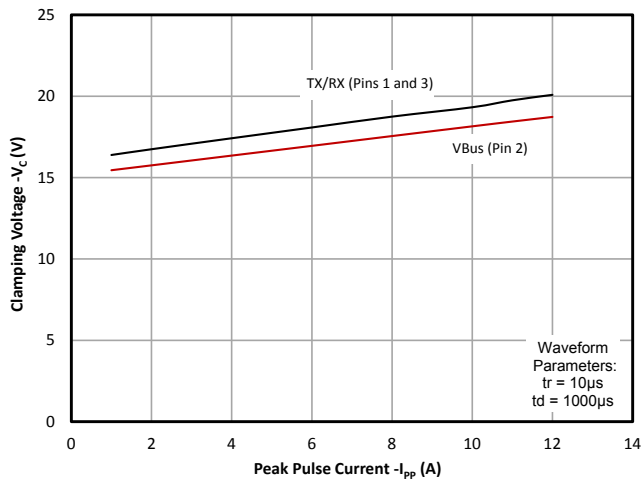

Clamping Voltage vs. Peak Pulse Current ($t_p = 8/20\mu\text{s}$)

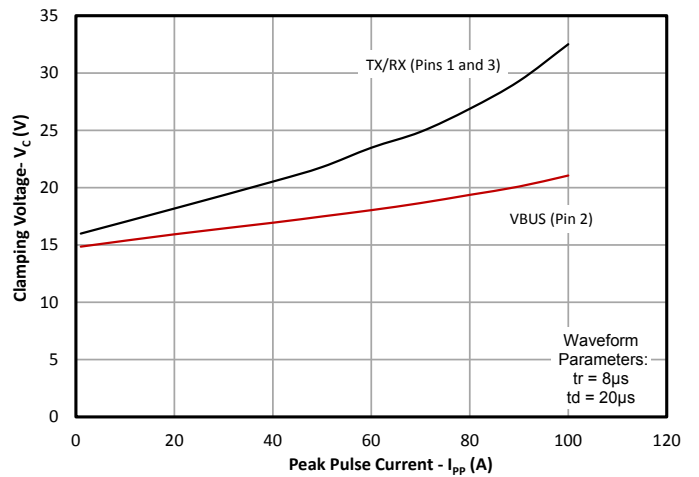

Forward Voltage vs. Peak Pulse Current ($t_p = 8/20\mu\text{s}$)

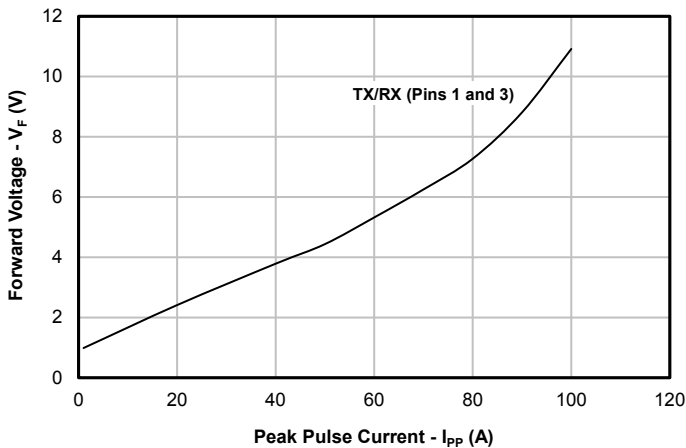

TLP Characteristic (Data Line Pins 1 and 3)

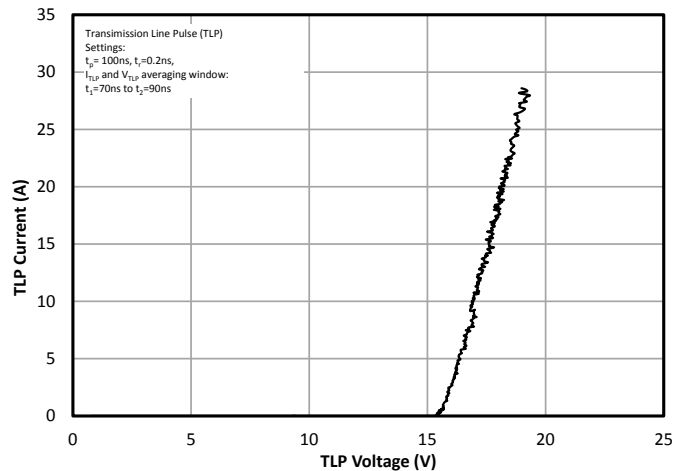

Typical Characteristics (Continued)

**ESD Clamping (8kV Contact per IEC 61000-4-2)
(Data Line Pins 1 and 3)**

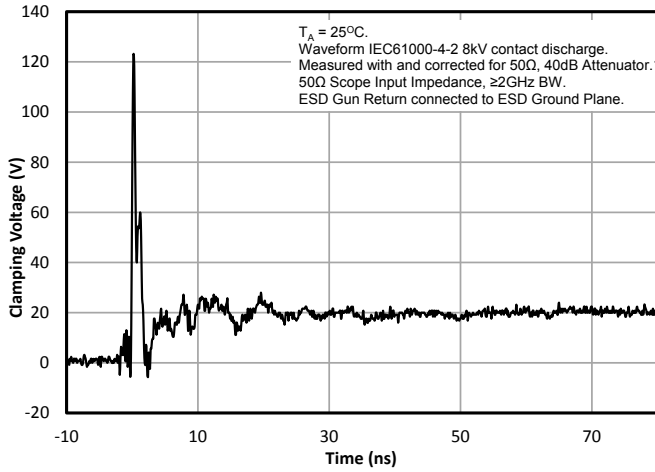

**ESD Clamping (-8kV Contact per IEC 61000-4-2)
(Data Line Pins 1 and 3)**

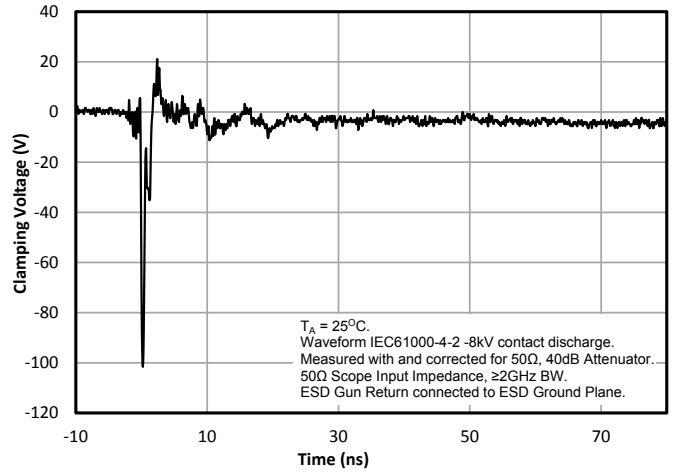

**ESD Clamping (8kV Contact per IEC 61000-4-2)
(VBus Pin 2)**

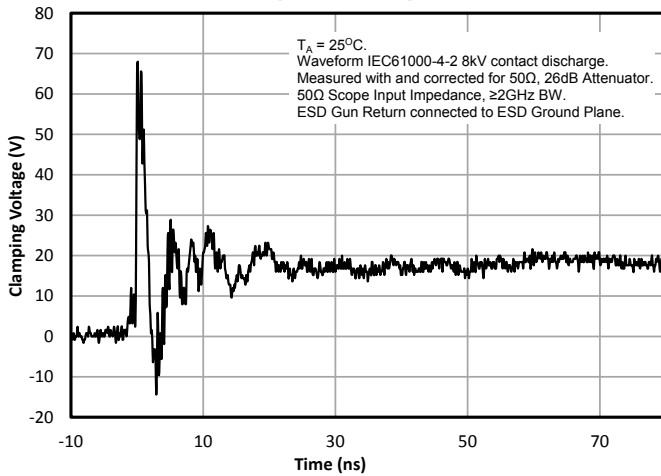

**ESD Clamping (-8kV Contact per IEC 61000-4-2)
(VBus Pin 2)**

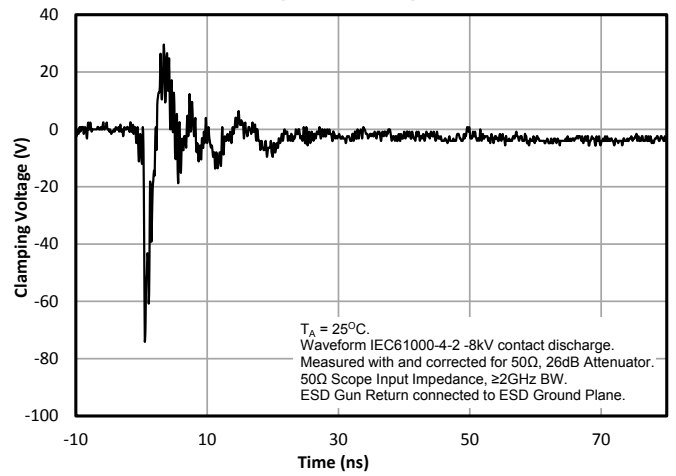

**Typical Insertion Loss S21
(Data Line Pins 1 and 3)**

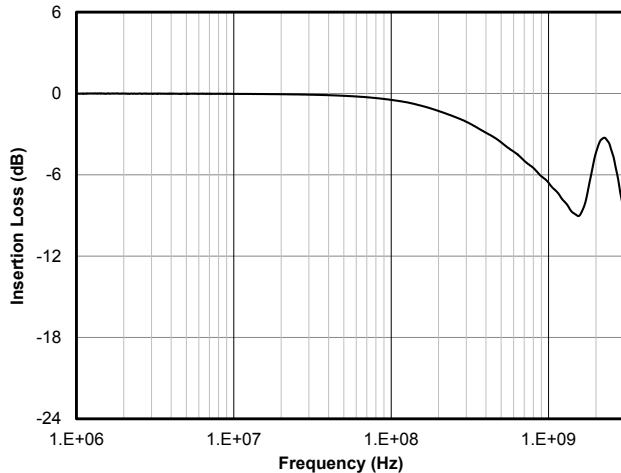

**Analog Crosstalk
(Pin1 to 3)**

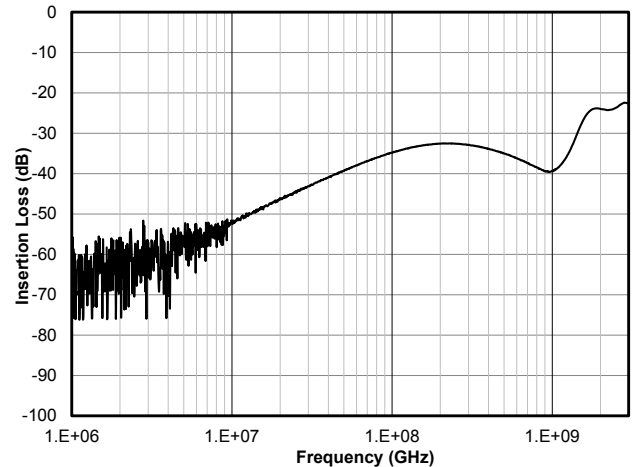

Application Information

Device Connection for Protection of RS-485 Interfaces

EIA RS-485 specifies a $\pm 7V$ ground difference between devices on the bus. This permits the bus voltage to range from +12V (5V + 7V) to -7V (0 - 7V). Because of this requirement, each TClamp1202P can be configured to protect one line for common mode surges or one line pair for differential surges. The example below illustrates how to connect the TClamp1202P for common mode and differential

mode protection on an RS-485 interface. For common mode protection, one of the TClamp1202P data pins (pin 1 or 3) is connected to the TX/RX line and the other is connected to ground. Pins 4 and 5 as well as the center tab are not connected. This effectively makes the device look like a bidirectional 12V TVS to the circuit. For differential mode protection, each of the device data pins (1 and 3) are connected to the transceiver RX/TX pins as shown. Again, Pins 4, 5 and the center tab are not connected.

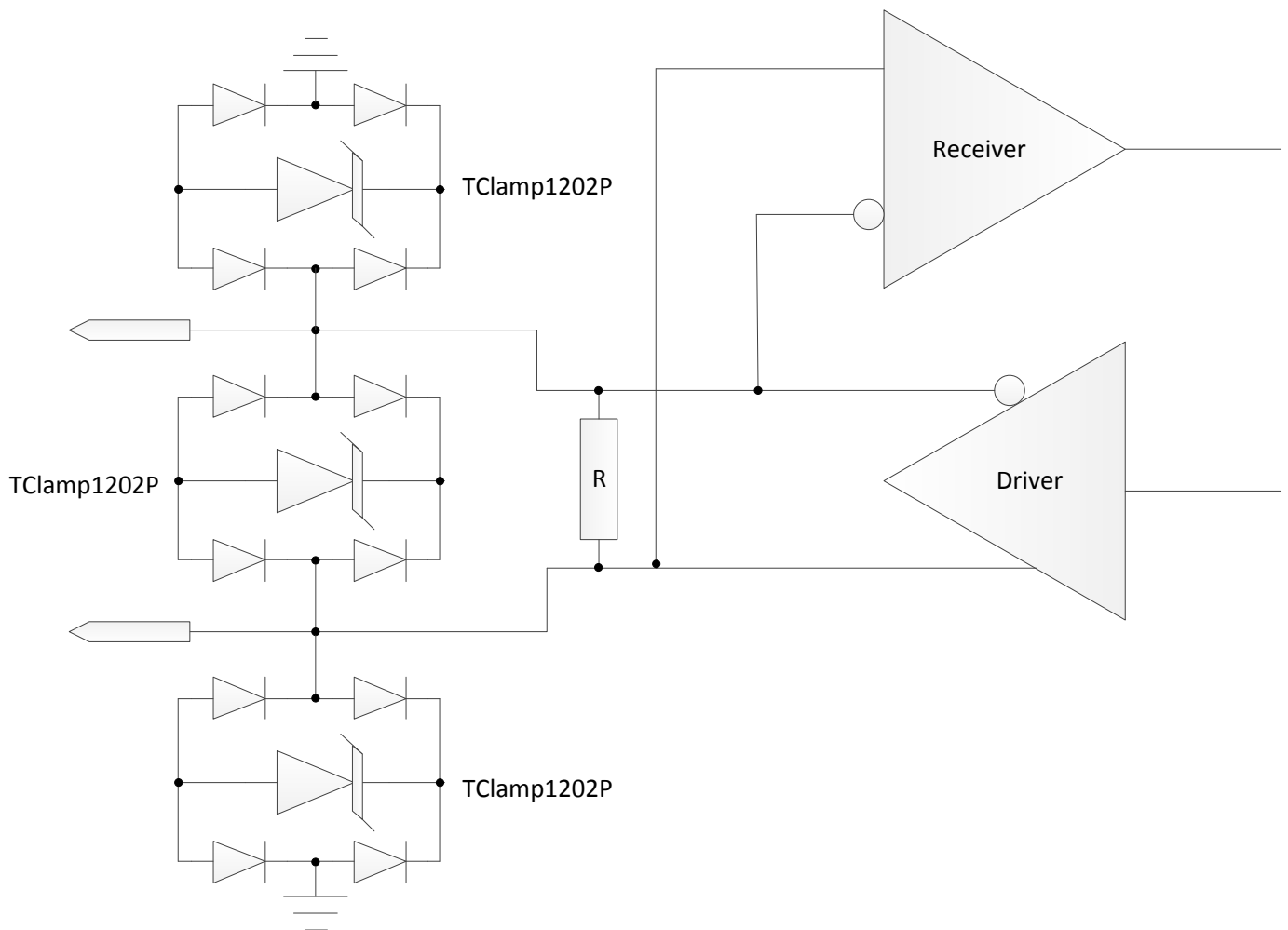

RS-485 Common Mode and Differential Mode Surge Protection

Outline Drawing - SLP2020P5

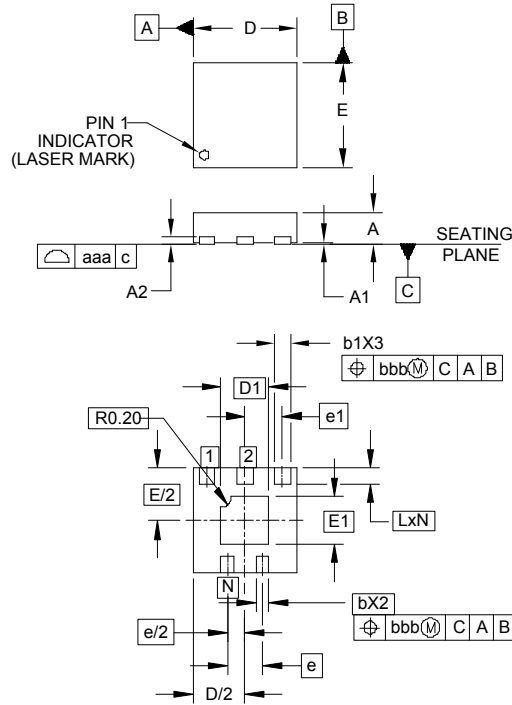

DIMENSIONS			
DIM	MILLIMETERS		
	MIN	NOM	MAX
A	0.50	0.60	0.65
A1	0.00	0.03	0.05
A2	(0.127)		
b	0.20	0.25	0.30
b1	0.25	0.30	0.35
D	1.90	2.00	2.10
D1	0.775	0.925	1.025
E	1.90	2.00	2.10
E1	0.75	0.90	1.00
e	0.675 BSC		
e1	0.725 BSC		
L	0.25	0.30	0.35
N	5		
aaa	0.08		
bbb	0.08		

NOTES:

1. CONTROLLING DIMENSIONS ARE IN MILLIMETERS (ANGLES IN DEGREES).
2. COPLANARITY APPLIES TO THE EXPOSED PAD AS WELL AS THE TERMINALS.

Land Pattern - SLP2020P5

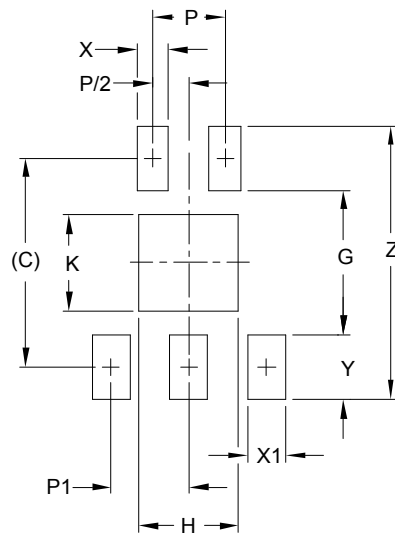

DIMENSIONS	
DIM	MILLIMETERS
C	(1.95)
G	1.35
H	0.925
K	0.900
P	0.675
P1	0.725
X	0.30
X1	0.35
Y	0.60
Z	2.55

NOTES:

1. CONTROLLING DIMENSIONS ARE IN MILLIMETERS (ANGLES IN DEGREES).
2. THIS LAND PATTERN IS FOR REFERENCE PURPOSES ONLY. CONSULT YOUR MANUFACTURING GROUP TO ENSURE YOUR COMPANY'S MANUFACTURING GUIDELINES ARE MET.

Marking Code

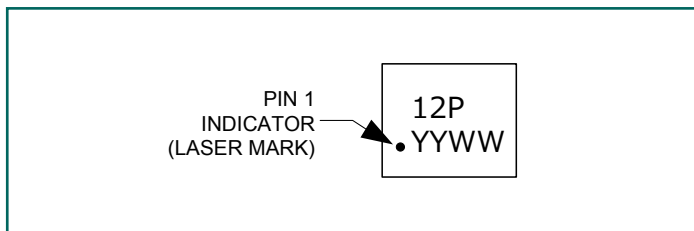

Note: YYWW = Alphanumeric character date code

Tape and Reel Specification

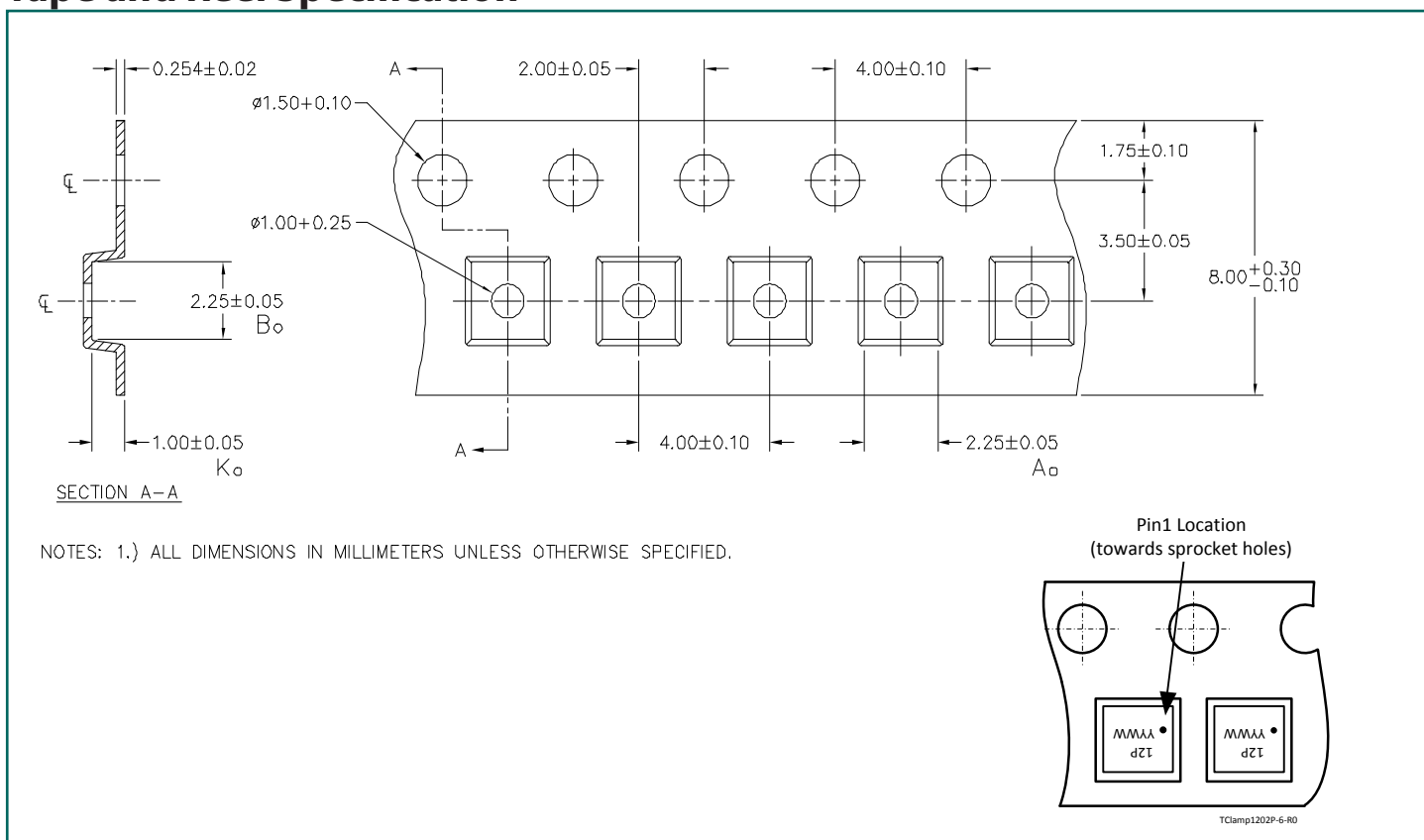

Ordering Information

Part Number	Qty per Reel	Reel Size
TClamp1202P.TGT	10,000	13"



IMPORTANT NOTICE

Information relating to this product and the application or design described herein is believed to be reliable, however such information is provided as a guide only and Semtech assumes no liability for any errors in this document, or for the application or design described herein. Semtech reserves the right to make changes to the product or this document at any time without notice. Buyers should obtain the latest relevant information before placing orders and should verify that such information is current and complete. Semtech warrants performance of its products to the specifications applicable at the time of sale, and all sales are made in accordance with Semtech's standard terms and conditions of sale.

SEMTECH PRODUCTS ARE NOT DESIGNED, INTENDED, AUTHORIZED OR WARRANTED TO BE SUITABLE FOR USE IN LIFE-SUPPORT APPLICATIONS, DEVICES OR SYSTEMS, OR IN NUCLEAR APPLICATIONS IN WHICH THE FAILURE COULD BE REASONABLY EXPECTED TO RESULT IN PERSONAL INJURY, LOSS OF LIFE OR SEVERE PROPERTY OR ENVIRONMENTAL DAMAGE. INCLUSION OF SEMTECH PRODUCTS IN SUCH APPLICATIONS IS UNDERSTOOD TO BE UNDERTAKEN SOLELY AT THE CUSTOMER'S OWN RISK. Should a customer purchase or use Semtech products for any such unauthorized application, the customer shall indemnify and hold Semtech and its officers, employees, subsidiaries, affiliates, and distributors harmless against all claims, costs damages and attorney fees which could arise.

The Semtech name and logo are registered trademarks of the Semtech Corporation. All other trademarks and trade names mentioned may be marks and names of Semtech or their respective companies. Semtech reserves the right to make changes to, or discontinue any products described in this document without further notice. Semtech makes no warranty, representation or guarantee, express or implied, regarding the suitability of its products for any particular purpose. All rights reserved.



© Semtech 2015

Contact Information

Semtech Corporation
200 Flynn Road, Camarillo, CA 93012
Phone: (805) 498-2111, Fax: (805) 498-3804
www.semtech.com

Looking for pricing, stock, or lifecycle information?

Click below to explore more details on WIN SOURCE:

-  [View TCLAMP1202P.TGT on WIN SOURCE](#)
-  [Semtech Corporation](#) Information

Optimize Your Supply Chain with WIN SOURCE Solutions

-  Global Sourcing Solution
-  Obsolete Management
-  Cost Control Management
-  Shortage Management
-  Alternative Solution
-  Excess Inventory Management