

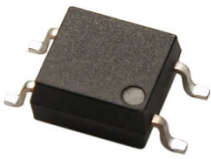

**THE DATASHEET OF
EL357NE(TA)-G**



4 PIN SOP PHOTOTRANSISTOR PHOTOCOUPLER EL357N-G Series



Schematic

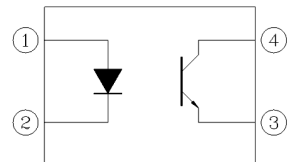

Pin Configuration

1. Anode
2. Cathode
3. Emitter
4. Collector

Features:

- Halogens free
- Current transfer ratio
(CTR: 50~600% at $I_F = 5\text{mA}$, $V_{CE} = 5\text{V}$)
- High isolation voltage between input and output (Viso=3750 V rms)
- Compact 4 Pin SOP with a 2.0 mm profile
- Pb free and RoHS compliant.
- UL approved (No. E214129)
- VDE approved (No. 132249)
- SEMKO approved
- NEMKO approved
- DEMKO approved
- FIMKO approved
- CSA approved (No. 1408633)

Description

The EL357N-G series contains an infrared emitting diode, optically coupled to a phototransistor detector.

The devices in a 4-pin small outline SMD package.

Applications

- DC-DC Converters
- Programmable controllers
- Telecommunication equipments
- Signal transmission between circuits of different potentials and impedances

Absolute Maximum Ratings (Ta=25°C)

	Parameter	Symbol	Rating	Unit
Input	Forward current	I_F	50	mA
	Peak forward current (1 us, pulse)	I_{FP}	1	A
	Reverse voltage	V_R	6	V
	Power dissipation Derating factor (about Ta=100°C)	P_D	70 2.9	mW mW/°C
Output	Power dissipation Derating factor (above Ta = 70°C)	P_C	150 3.7	mW mW/°C
	Collector current	I_C	50	mA
	Collector-Emitter voltage	V_{CEO}	80	V
	Emitter-Collector voltage	V_{ECO}	7	V
	Total Power Dissipation	P_{TOT}	200	mW
Isolation Voltage*1	V_{ISO}	3750	V rms	
Operating temperature	T_{OPR}	-55 ~ +110	°C	
Storage temperature	T_{STG}	-55 ~ +125	°C	
Soldering Temperature*2	T_{SOL}	260	°C	

Notes:

*1 AC for 1 minute, R.H.= 40 ~ 60% R.H. In this test, pins 1, 2 are shorted together, and pins 3, 4 are shorted together.

*2 For 10 seconds

Electro-Optical Characteristics (Ta=25°C unless specified otherwise)

Input

Parameter	Symbol	Min.	Typ.	Max.	Unit	Condition
Forward voltage	V_F	-	1.2	1.4	V	$I_F = 20\text{mA}$
Reverse current	I_R	-	-	10	μA	$V_R = 4\text{V}$
Input capacitance	C_{in}	-	30	250	pF	$V = 0, f = 1\text{kHz}$

Output

Parameter	Symbol	Min	Typ.	Max.	Unit	Condition
Collector-Emitter dark current	I_{CEO}	-	-	100	nA	$V_{CE} = 20\text{V}, I_F = 0\text{mA}$
Collector-Emitter breakdown voltage	BV_{CEO}	80	-	-	V	$I_C = 0.1\text{mA}$
Emitter-Collector breakdown voltage	BV_{ECO}	7	-	-	V	$I_E = 0.01\text{mA}$

Transfer Characteristics (Ta=25°C unless specified otherwise)

Parameter	Symbol	Min	Typ.	Max.	Unit	Condition
Current Transfer ratio	EL357N	50	-	600	%	$I_F = 5\text{mA}, V_{CE} = 5\text{V}$
	EL357NA	80	-	160		
	EL357NB	130	-	260		
	EL357NC	200	-	400		
	EL357ND	300	-	600		
	EL357NE	100	-	200		
	EL357NF	150	-	300		
Collector-Emitter saturation voltage	$V_{CE(sat)}$	-	0.1	0.2	V	$I_F = 20\text{mA}, I_C = 1\text{mA}$
Isolation resistance	R_{IO}	5×10^{10}	-	-	Ω	$V_{IO} = 500\text{Vdc}, 40\sim 60\% \text{ R.H.}$
Floating capacitance	C_{IO}	-	0.6	1.0	pF	$V_{IO} = 0, f = 1\text{MHz}$
Rise time	t_r	-	3	18	μs	$V_{CE} = 2\text{V}, I_C = 2\text{mA}, R_L = 100\Omega$
Fall time	t_f	-	4	18		

* Typical values at $T_a = 25^\circ\text{C}$

Typical Electro-Optical Characteristics Curves

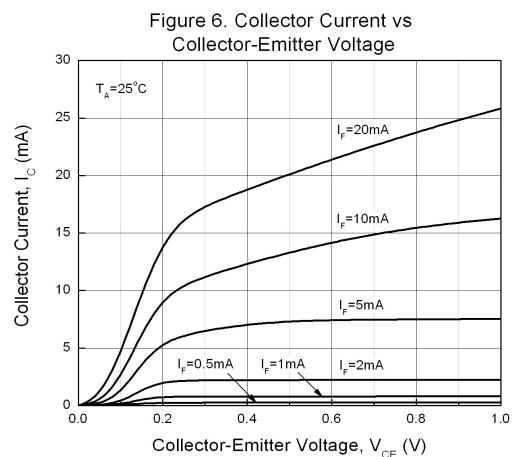
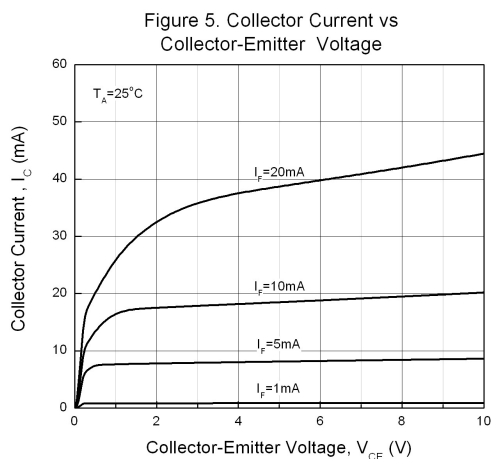
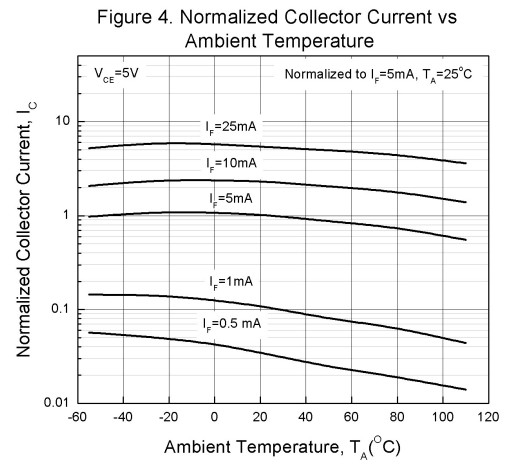
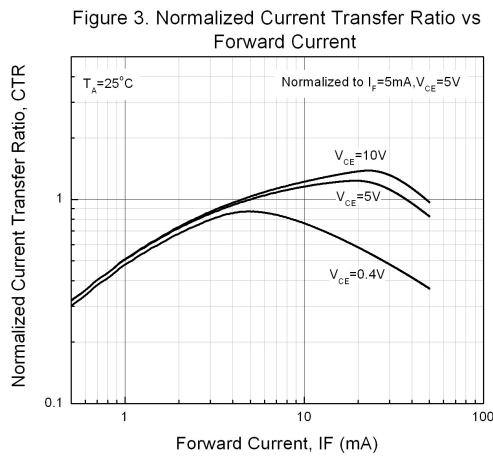
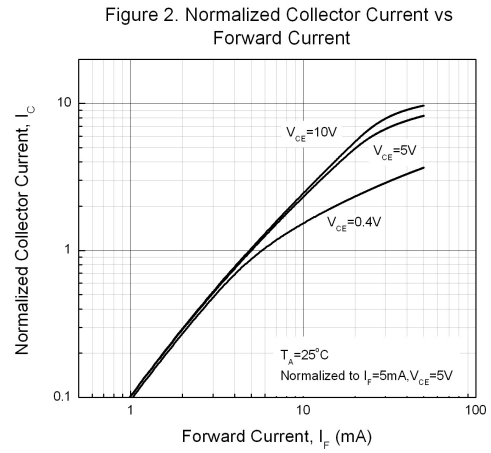
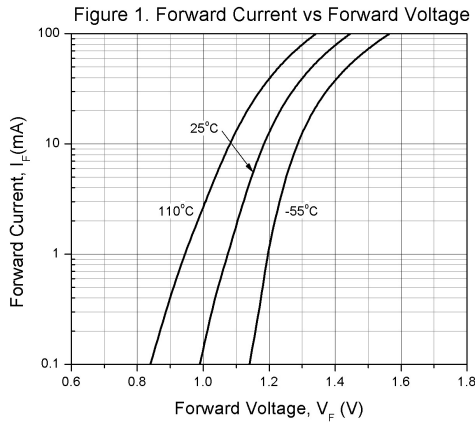

Figure 7. Collector Dark Current vs Ambient Temperature

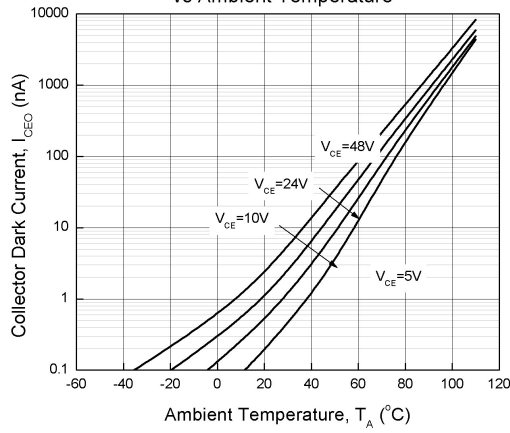

Figure 8. Switching Time vs Load Resistance

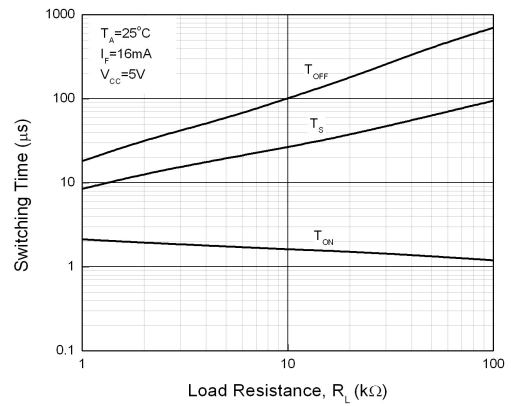

Figure 9. Collector-Emitter Saturation Voltage vs Ambient Temperature

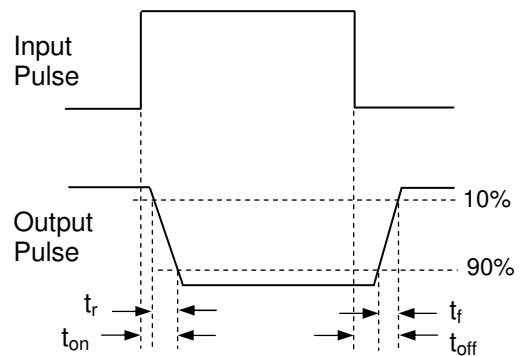
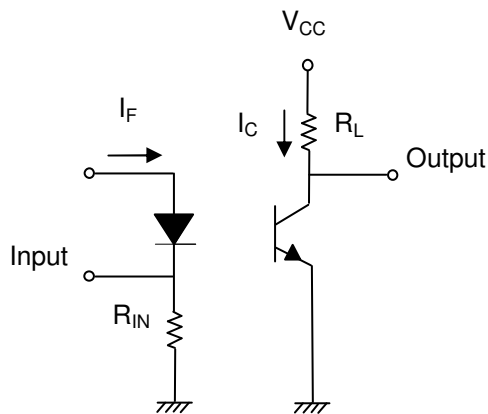
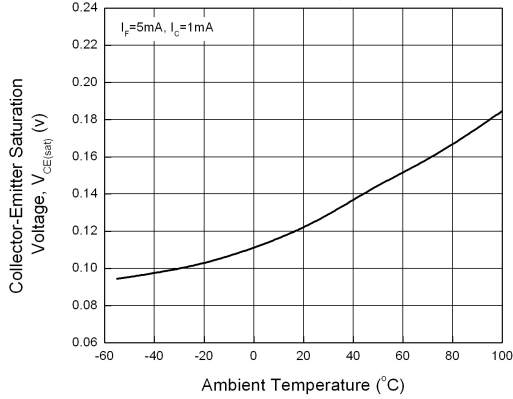

Figure 10. Switching Time Test Circuit & Waveforms

Order Information

Part Number

EL357N(X)(Y)-VG

Note

- X = CTR Rank (A, B, C, D, E, For none)
- Y = Tape and reel option (TA, TB, or none).
- V = VDE (option)
- G = Halogens free

Option	Description	Packing quantity
None	Standard SMD option	100 units per tube
-V	Standard SMD option + VDE	100 units per tube
(TA)	TA Tape & reel option	3000 units per reel
(TB)	TB Tape & reel option	3000 units per reel
(TA)-V	TA Tape & reel option + VDE	3000 units per reel
(TB)-V	TB Tape & reel option + VDE	3000 units per reel

Package Dimension (Dimensions in mm)

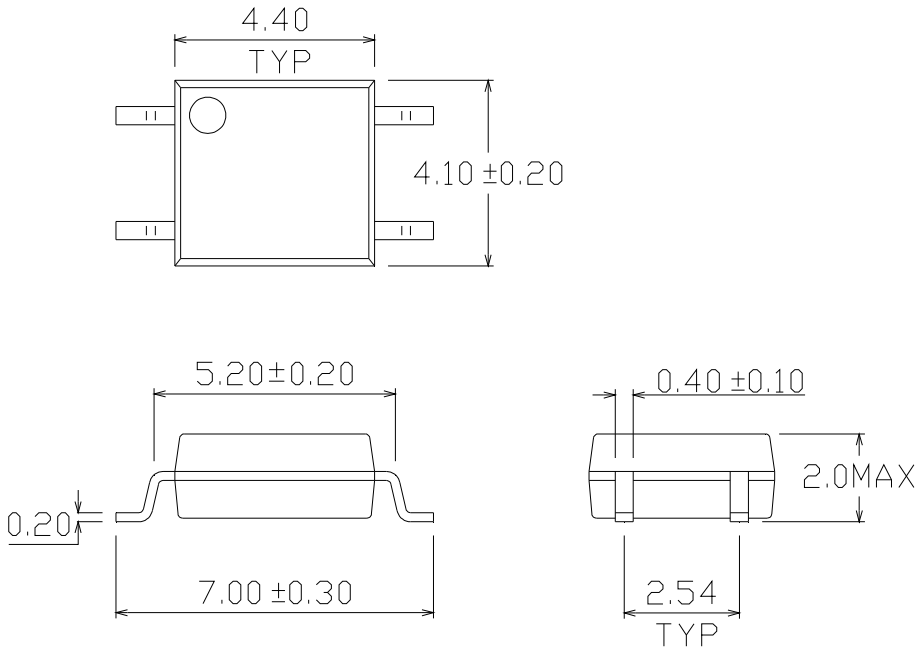

Recommended pad layout for surface mount leadform

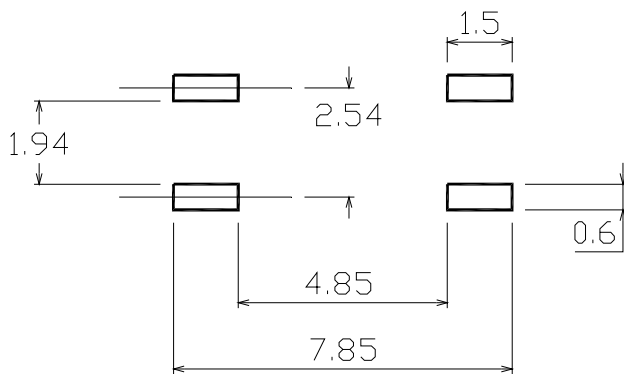

Device Marking



Notes

EL	denotes Everlight
357N	denotes Device Number
R	denotes CTR Rank
Y	denotes 1 digit Year code
WW	denotes 2 digit Week code
V	denotes VDE approved (optional)

Tape & Reel Packing Specifications

Option TA

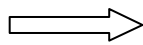
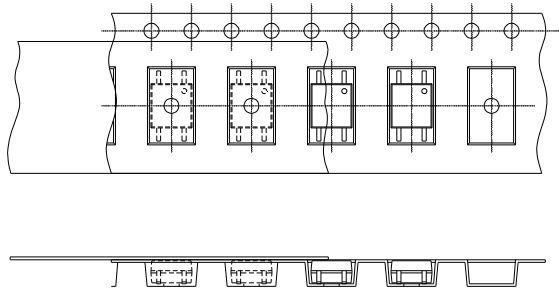

Direction of feed from reel

Option TB

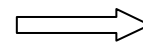
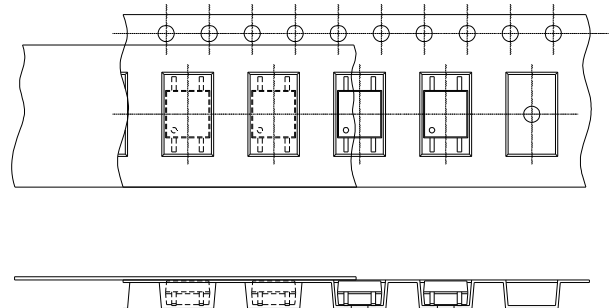

Direction of feed from reel

Tape dimensions

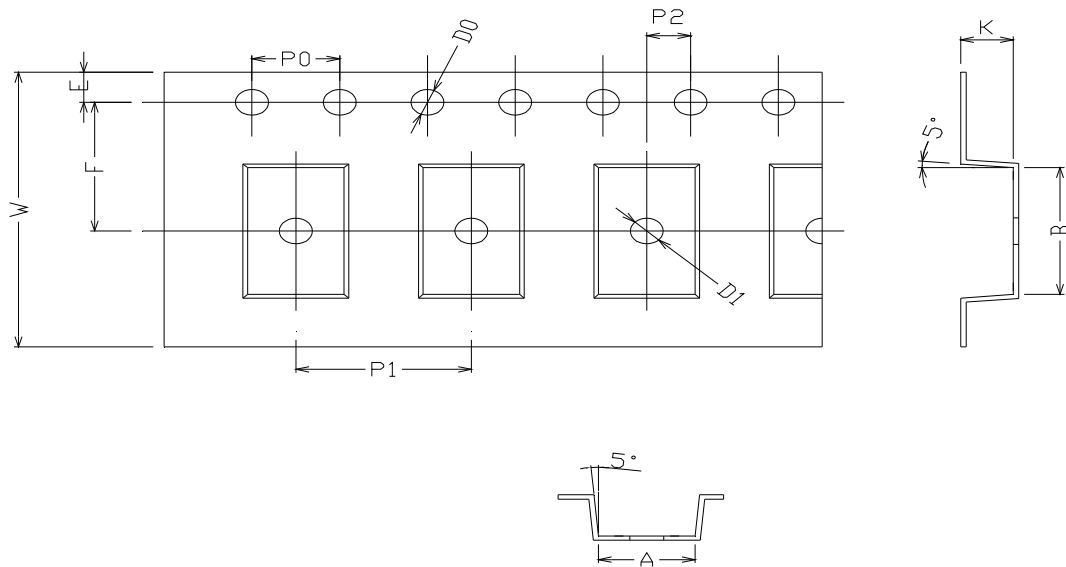

Dimension No.	A	B	Do	D1	E	F
Dimension (mm)	4.4 ± 0.1	7.4 ± 0.1	1.5 + 0.1/-0	1.5 ± 0.1	1.75 ± 0.1	7.5 ± 0.1
Dimension No.	Po	P1	P2	t	W	K
Dimension (mm)	4.0 ± 0.15	8.0 ± 0.1	2.0 ± 0.1	0.25 ± 0.03	16.0 ± 0.2	2.4 ± 0.1

Precautions for Use

1. Soldering Condition

1.1 (A) Maximum Body Case Temperature Profile for evaluation of Reflow Profile

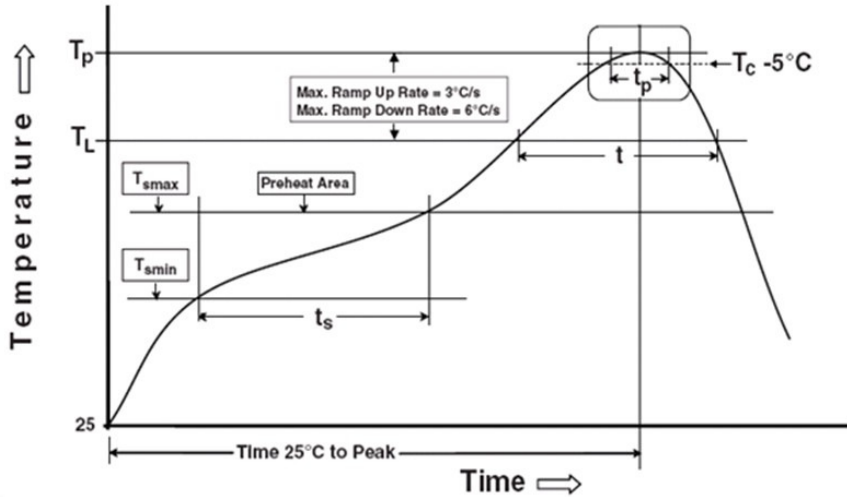

Note:

Reference: IPC/JEDEC J-STD-020D

Preheat

Temperature min (T_{smin})	150 °C
Temperature max (T_{smax})	200 °C
Time (T_{smin} to T_{smax}) (t_s)	60-120 seconds
Average ramp-up rate (T_{smax} to T_p)	3 °C/second max

Other



Liquidus Temperature (T_L)	217 °C
Time above Liquidus Temperature (t_L)	60-100 sec
Peak Temperature (T_P)	260 °C
Time within 5 °C of Actual Peak Temperature: $T_P - 5^\circ\text{C}$	30 s
Ramp- Down Rate from Peak Temperature	6 °C /second max.
Time 25 °C to peak temperature	8 minutes max.
Reflow times	3 times

DISCLAIMER

1. Above specification may be changed without notice. EVERLIGHT will reserve authority on material change for above specification.
2. When using this product, please observe the absolute maximum ratings and the instructions for using outlined in these specification sheets. EVERLIGHT assumes no responsibility for any damage resulting from use of the product which does not comply with the absolute maximum ratings and the instructions included in these specification sheets.
3. These specification sheets include materials protected under copyright of EVERLIGHT corporation. Please don't reproduce or cause anyone to reproduce them without EVERLIGHT's consent.

Looking for pricing, stock, or lifecycle information?

Click below to explore more details on WIN SOURCE:

-  [View EL357NE\(TA\)-G on WIN SOURCE](#)
-  [Everlight Electronics Co Ltd Information](#)

Optimize Your Supply Chain with WIN SOURCE Solutions

-  Global Sourcing Solution
-  Obsolete Management
-  Cost Control Management
-  Shortage Management
-  Alternative Solution
-  Excess Inventory Management