

! Partly to Be Discontinued
Last time buy: September 30, 2019

For board-to-board | For board-to-FPC

Narrow pitch connectors (0.4mm pitch)

P4



• Without soldering terminals



! **• With soldering terminals**



RoHS compliant

FEATURES

1. 0.4 mm pitch and mated heights of 1.5 mm, 2.0 mm, 2.5 mm, 3.0 mm and 3.5 mm.
2. Strong resistance to adverse environments! Utilizes **“TOUGH CONTACT”** construction for high contact reliability.
3. Constructed with impact dispersion keys inside the body to disperse shocks when dropped.



A high level of shock resistance is ensured by dispersing impact over the four locations where the socket indentations and header protrusions are mated together.

Note: The following number of pins are not supported due to suction surface factors.

- Without soldering terminals: 18 pins or less

4. Construction makes designing devices easier.

The lower connector bottom surface construction prevents contact and shorts between the PCB and metal terminals. This enables freedom in pattern wiring, helping to make PCB's smaller.



5. Contributes to improved mating
1) Guides are provided to take up any position shift and facilitate insertion.

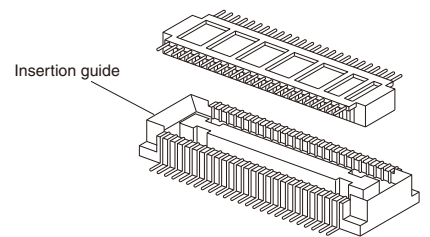

2) Simple lock structure provides tactile feedback to ensure excellent mating/unmating operation feel.

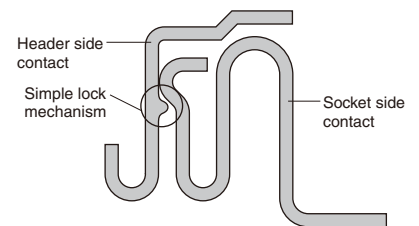

6. Design facilitates efficient mounting.

Features a terminal flatness of 0.08 mm, construction resistant to creeping flux, and design that allows visual inspection of the soldered part.

! **7. Connectors for inspection available**

APPLICATIONS

- Mobile devices, such as cellular phones, digital still cameras and digital video cameras.
- Board-to-board connection in measuring devices and industrial equipment, etc.
- Consumer equipment such as handheld terminals

ORDERING INFORMATION

AXK **G**

7: Narrow Pitch Connector P4 (0.4 mm pitch) Socket
8: Narrow Pitch Connector P4 (0.4 mm pitch) Header

Number of pins (2 digits)

Mated height

<Socket>

1: For mated height 1.5 mm

2: For mated height 2.0 mm

3: For mated height 2.5 mm and 3.0 mm

4: For mated height 3.5 mm

<Header>

1: For mated height 1.5 mm, 2.0 mm and 2.5 mm

2: For mated height 3.0 mm and 3.5 mm

Functions

2: With soldering terminals, without positioning bosses

4: Without soldering terminals, without positioning bosses

Surface treatment (Contact portion / Terminal portion)

<Socket>

7: Ni plating on base, Au plating on surface (for Ni barrier available)

<Header>

5: Ni plating on base, Au plating on surface

Other specifications

<Header>

W: V notch

Packing

G: 3,000 pieces embossed tape and plastic reel × 2*

Notes: 1. Only a socket of mated height 3.5 mm: 2,000 pieces embossed tape and plastic reel × 2.

2. Please note that the models with a soldering terminals (8th digit of part number is "2") and those without a soldering terminals (8th digit of part number is "4") are shaped differently and are not compatible.

PRODUCT TYPES

1. Without soldering terminals

Mated height	Number of pins	Part number		Packing	
		Socket	Header	Inner carton	Outer carton
1.5 mm	14	AXK714147G	AXK814145WG	3,000 pieces	6,000 pieces
	20	AXK720147G	AXK820145WG		
	! 22	AXK722147G	AXK822145WG		
	24	AXK724147G	AXK824145WG		
	26	AXK726147G	AXK826145WG		
	30	AXK730147G	AXK830145WG		
	! 34	AXK734147G	AXK834145WG		
	40	AXK740147G	AXK840145WG		
	! 44	AXK744147G	AXK844145WG		
	50	AXK750147G	AXK850145WG		
	! 54	AXK754147G	AXK854145WG		
	60	AXK760147G	AXK860145WG		
	! 64	AXK764147G	AXK864145WG		
	70	AXK770147G	AXK870145WG		
2.0 mm	80	AXK780147G	AXK880145WG		
	100	AXK700147G	AXK800145WG		
	14	AXK714247G	AXK814145WG		
	20	AXK720247G	AXK820145WG		
	24	AXK724247G	AXK824145WG		
	26	AXK726247G	AXK826145WG		
	30	AXK730247G	AXK830145WG		
	40	AXK740247G	AXK840145WG		
2.5 mm	50	AXK750247G	AXK850145WG		
	60	AXK760247G	AXK860145WG		
	70	AXK770247G	AXK870145WG		
	80	AXK780247G	AXK880145WG		
	14	AXK714347G	AXK814145WG		
	20	AXK720347G	AXK820145WG		
	24	AXK724347G	AXK824145WG		
	30	AXK730347G	AXK830145WG		
3.0 mm	40	AXK740347G	AXK840145WG		
	50	AXK750347G	AXK850145WG		
	60	AXK760347G	AXK860145WG		
	70	AXK770347G	AXK870145WG		
	80	AXK780347G	AXK880145WG		
	20	AXK720347G	AXK820245WG		
3.5 mm	24	AXK724347G	AXK824245WG		
	30	AXK730347G	AXK830245WG		
	40	AXK740347G	AXK840245WG		
	50	AXK750347G	AXK850245WG		
	60	AXK760347G	AXK860245WG		
3.5 mm	80	AXK780347G	AXK880245WG		
	20	AXK720447G	AXK820245WG	Socket: 2,000 pieces Header: 3,000 pieces	Socket: 4,000 pieces Header: 6,000 pieces
	30	AXK730447G	AXK830245WG		
40	AXK740447G	AXK840245WG			

Note: Regarding ordering units; During production: Please make orders in 1-reel units.
For samples, please contact our sales office.

2. With soldering terminals

Mated height	Number of pins	Part number		Packing	
		Socket	Header	Inner carton	Outer carton
1.5 mm	10	AXK710127G	AXK810125WG	3,000 pieces	6,000 pieces
	34	AXK734127G	AXK834125WG		
	40	AXK740127G	AXK840125WG		
2.0 mm	34	AXK734227G	AXK834125WG		
2.5 mm	12	AXK712327G	AXK812125WG		
	20	AXK720327G	AXK820125WG		
	32	AXK732327G	AXK832125WG		
	40	AXK740327G	AXK840125WG		
3.0 mm	20	AXK720327G	AXK820225WG		
	36	AXK736327G	AXK836225WG		
	60	AXK760327G	AXK860225WG		
	70	AXK770327G	AXK870225WG		
3.5 mm	80	AXK780327G	AXK880225WG	Socket: 2,000 pieces Header: 3,000 pieces	Socket: 4,000 pieces Header: 6,000 pieces
	60	AXK760427G	AXK860225WG		
	70	AXK770427G	AXK870225WG		
	80	AXK780427G	AXK880225WG		

Note: Regarding ordering units; During production: Please make orders in 1-reel units.
 For samples, please contact our sales office.

SPECIFICATIONS

1. Characteristics

Item	Specifications	Conditions																			
Electrical characteristics	Rated current	0.3A/pin contact (Max. 5 A at total pin contacts)																			
	Rated voltage	60V AC/DC																			
	Dielectric strength	150V AC for 1 min.	Detection current: 1mA																		
	Insulation resistance	Min. 1,000MΩ (initial)	Using 250V DC megger (applied for 1 min.)																		
	Contact resistance	Max. 70mΩ	Based on the contact resistance measurement method specified by JIS C 5402.																		
Mechanical characteristics	Composite insertion force	Max. 0.981N/pin contact × pin contacts (initial)																			
	Composite removal force	Min. 0.0588N/pin contact × pin contacts (Mated height 1.5 mm) Min. 0.118N/pin contact × pin contacts (Mated height 2.0 ~ 3.5 mm)																			
	Post holding force	Min. 0.981N/pin contact	Measuring the maximum force. As the contact is axially pull out.																		
Environmental characteristics	Ambient temperature	-55°C to +85°C	No icing or condensation.																		
	Soldering heat resistance	Max. peak temperature of 260°C (on the surface of the PC board around the connector terminals) 300°C within 5 sec. 350°C within 3 sec.	Infrared reflow soldering Soldering iron																		
	Storage temperature	-55°C to +85°C (product only) -40°C to +50°C (emboss packing)	No icing or condensation.																		
	Thermal shock resistance (header and socket mated)	5 cycles, insulation resistance min. 100MΩ, contact resistance max. 70mΩ	Conformed to MIL-STD-202F, method 107G <table border="1"> <thead> <tr> <th>Order</th> <th>Temperature (°C)</th> <th>Time (minutes)</th> </tr> </thead> <tbody> <tr> <td>1</td> <td>-55_{±3}</td> <td>30</td> </tr> <tr> <td>2</td> <td>∅</td> <td>Max. 5</td> </tr> <tr> <td>3</td> <td>85_{±3}</td> <td>30</td> </tr> <tr> <td>4</td> <td>∅</td> <td>Max. 5</td> </tr> <tr> <td></td> <td>-55_{±3}</td> <td></td> </tr> </tbody> </table>	Order	Temperature (°C)	Time (minutes)	1	-55 _{±3}	30	2	∅	Max. 5	3	85 _{±3}	30	4	∅	Max. 5		-55 _{±3}	
	Order	Temperature (°C)	Time (minutes)																		
	1	-55 _{±3}	30																		
	2	∅	Max. 5																		
	3	85 _{±3}	30																		
4	∅	Max. 5																			
	-55 _{±3}																				
Humidity resistance (header and socket mated)	120 hours, insulation resistance min. 100MΩ, contact resistance max. 70mΩ	Conformed to IEC60068-2-78 Bath temperature 40°C±2°C, humidity 90% to 95% R.H.																			
Saltwater spray resistance (header and socket mated)	24 hours, insulation resistance min. 100MΩ, contact resistance max. 70mΩ	Conformed to IEC60068-2-11 Bath temperature 35°C±2°C, saltwater concentration 5%±1%																			
H ₂ S resistance (header and socket mated)	48 hours, contact resistance max. 70mΩ	Bath temperature 40°C±2°C, gas concentration 3 ppm ±1 ppm, humidity 75% to 80% R.H.																			
Lifetime characteristics	Insertion and removal life	50 times Repeated insertion and removal speed of max. 200 times/hours																			
Unit weight	Mated height 1.5mm, 20 pin contacts; Socket: 0.04g Header: 0.02g																				

2. Material and surface treatment

Part name	Material	Surface treatment
Molded portion	LCP resin (UL94V-0)	—
Contact/Post	Copper alloy	Contact portion: Ni plating on base, Au plating on surface Terminal portion: Ni plating on base, Au plating on surface (Except for thick of terminal) However, upper terminal of Ni barrier production: Exposed over Ni The area adjacent to the terminal of the sockets on models with Ni barrier is exposed to Ni on base.
Soldering terminals portion	Copper alloy	Ni plating on base, Sn plating on surface (Except for front terminal)

DIMENSIONS (Unit: mm)

The CAD data of the products with a **CAD Data** mark can be downloaded from: <http://industrial.panasonic.com/ac/e/>

1. Without Soldering Terminals

Socket (Mated height: 1.5 mm, 2.0 mm, 2.5 mm, 3.0 mm and 3.5 mm)

CAD Data



Max. 18 pin contacts

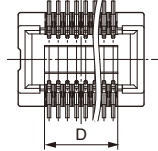

General tolerance: ± 0.2

Dimension table (mm)

Number of pins/ dimension	A	B	C	D
14	5.10	2.40	—	2.80
20	6.30	3.60	1.60	—
22	6.70	4.00	2.00	—
24	7.10	4.40	2.40	—
26	7.50	4.80	2.80	—
30	8.30	5.60	3.60	—
34	9.10	6.40	4.40	—
40	10.30	7.60	5.60	—
44	11.10	8.40	6.40	—
50	12.30	9.60	7.60	—
54	13.10	10.40	8.40	—
60	14.30	11.60	9.60	—
64	15.10	12.40	10.40	—
70	16.30	13.60	11.60	—
80	18.30	15.60	13.60	—
100	22.30	19.60	17.60	—

Mated height/dimension	E
1.5mm	1.50
2.0mm	1.92
2.5mm, 3.0mm	2.42
3.5mm	2.92

Header (Mated height: 1.5 mm, 2.0 mm, 2.5 mm, 3.0 mm and 3.5 mm)

CAD Data



Max. 18 pin contacts

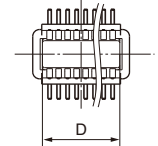

General tolerance: ± 0.2

Dimension table (mm)

Number of pins/ dimension	A	B	C	D
14	3.90	2.40	—	3.04
20	5.10	3.60	1.60	—
22	5.50	4.00	2.00	—
24	5.90	4.40	2.40	—
26	6.30	4.80	2.80	—
30	7.10	5.60	3.60	—
34	7.90	6.40	4.40	—
40	9.10	7.60	5.60	—
44	9.90	8.40	6.40	—
50	11.10	9.60	7.60	—
54	11.90	10.40	8.40	—
60	13.10	11.60	9.60	—
64	13.90	12.40	10.40	—
70	15.10	13.60	11.60	—
80	17.10	15.60	13.60	—
100	21.10	19.60	17.60	—

Mated height/dimension	E	F
1.5mm, 2.0mm, 2.5mm	1.31	1.20
3.0mm, 3.5mm	2.26	1.26

Socket and Header are mated

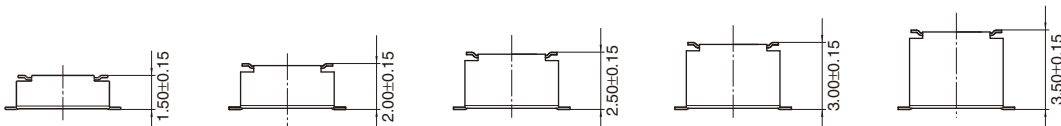

2. With Soldering Terminals

Socket (Mated height: 1.5 mm, 2.0 mm, 2.5 mm, 3.0 mm and 3.5 mm)

CAD Data



Dimension table (mm)

Number of pins/ dimension	A	B	C	D	E
10	5.90	1.60	—	4.60	2.00
12	6.30	2.00	—	5.00	2.40
20	7.90	3.60	—	6.60	2.40
32	10.30	6.00	3.20	9.00	—
34	10.70	6.40	3.60	9.40	—
36	11.10	6.80	4.00	9.40	—
40	11.90	7.60	4.80	10.60	—
60	15.90	11.60	8.80	14.60	—
70	17.90	13.60	10.80	16.60	—
80	19.90	15.60	12.80	18.60	—

Mated height/dimension	F
1.5mm	1.50
2.0mm	1.92
2.5mm, 3.0mm	2.42
3.5mm	2.92

General tolerance: ±0.2

Header (Mated height: 1.5 mm, 2.0 mm, 2.5 mm, 3.0 mm and 3.5 mm)

CAD Data

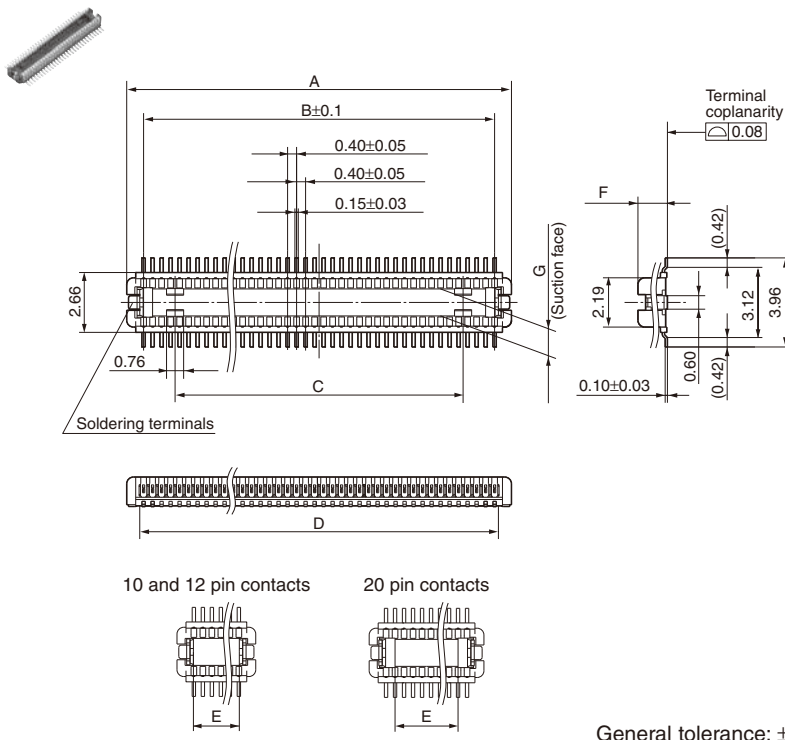

Dimension table (mm)

Number of pins/ dimension	A	B	C	D	E
10	3.10	1.60	—	1.94	1.64
12	3.50	2.00	—	2.34	2.04
20	5.10	3.60	—	3.94	2.80
32	7.50	6.00	3.20	6.34	—
34	7.90	6.40	3.60	6.74	—
36	8.30	6.80	4.00	7.14	—
40	9.10	7.60	4.80	7.94	—
60	13.10	11.60	8.80	11.94	—
70	15.10	13.60	10.80	13.94	—
80	17.10	15.60	12.80	15.94	—

Mated height/dimension	F	G
1.5mm, 2.0mm, 2.5mm	1.31	1.20
3.0mm, 3.5mm	2.26	1.26

General tolerance: ±0.2

Socket and Header are mated.



EMBOSSED TAPE DIMENSIONS (unit: mm)

• Tape dimensions (Conforming to JIS C 0806:1990.
However, some tapes have mounting hole pitches that do not comply with the standard.)

• Plastic reel dimensions (Conforming to EIAJ ET-7200B)



Dimension table (mm)

1. Without Soldering Terminals

Mated height	Number of pins		Type of taping	A	B	C	D	Quantity per reel
	Socket	Header						
Common for socket and header: 1.5 mm, 2.0 mm, 2.5 mm and 3.0 mm Header: 3.5 mm	Max. 18	Max. 18	Tape I	16.0	—	7.5	17.4	3,000
	20 to 70	20 to 70	Tape I	24.0	—	11.5	25.4	3,000
Header: 3.5 mm	80 to 100	80 to 100	Tape II	32.0	28.4	14.2	33.4	3,000
Socket: 3.5 mm	20 to 40		Tape I	24.0	—	11.5	25.4	2,000

2. With Soldering Terminals

Mated height	Number of pins		Type of taping	A	B	C	D	Quantity per reel
	Socket	Header						
Common for socket and header: 1.5 mm, 2.0 mm, 2.5 mm and 3.0 mm Header: 3.5 mm	Max. 18	Max. 18	Tape I	16.0	—	7.5	17.4	3,000
	20 to 60	20 to 70	Tape I	24.0	—	11.5	25.4	3,000
Header: 3.5 mm	70 to 80	80	Tape II	32.0	28.4	14.2	33.4	3,000
Socket: 3.5 mm	60		Tape I	24.0	—	11.5	25.4	2,000
	70 to 80		Tape II	32.0	28.4	14.2	33.4	2,000

3. Connector orientation with respect to direction of progress of embossed tape

1) Without soldering terminals



2) With soldering terminals

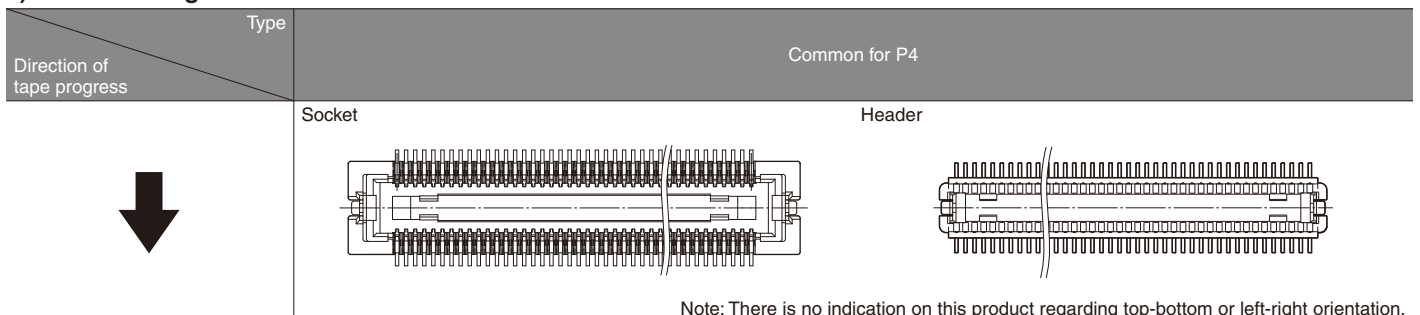

For board-to-board	For board-to-FPC
Connectors for inspection usage (0.4mm pitch)	
P4	



RoHS compliant

FEATURES

- 1. 3,000 mating and unmating cycles**
- 2. Same external dimensions and foot pattern as standard type.**
- 3. Improved mating**
Insertion and removal easy due to a reduction in mating retention force. This is made possible by a simple locking structure design.

APPLICATIONS

Ideal for module unit inspection and equipment assembly inspection
Note: Mating retention force cannot be warranted. Please avoid using for applications other than inspection.

TABLE OF PRODUCT TYPES

☆: Available for sale

Product name	Number of pins																	
	10	12	14	20	22	24	26	30	34	40	44	50	54	60	64	70	80	100
P4 for inspection without soldering terminals			☆	☆	☆	☆	☆	☆	☆	☆	☆	☆	☆	☆	☆	☆	☆	☆
P4 for inspection with soldering terminals	☆	☆		☆					☆	☆				☆			☆	

- Notes:
1. You can use with each mated height in common.
 2. Please inquire about number of pins other than those shown above.
 3. Please inquire with us regarding availability.
 4. Please keep the minimum order quantities no less than 50 pieces per lot.
 5. Please inquire if further information is needed.

PRODUCT TYPES

Specifications		Part No.	Specifications		Part No.
Socket	Without soldering terminals	AXK7E**46G	Header	Without soldering terminals	AXK8E**46WG
	With soldering terminals	AXK7E**26G		With soldering terminals	AXK8E**26WG

Note: When placing an order, substitute the "*" (asterisk) in the above part number with the number of pins for the specific connector.

NOTES

1. As shown below, excess force during insertion may result in damage to the connector or removal of the solder. Also, to prevent connector damage please confirm the correct position before mating connectors.



2. Keep the PC board warp no more than 0.03 mm in relation to the overall length of the connector.



3. Recommended PC board and metal mask patterns

Connectors are mounted with high pitch density, intervals of 0.35 mm, 0.4 mm or 0.5 mm.

In order to reduce solder and flux rise, solder bridges and other issues make sure the proper levels of solder is used. The figures to the right are recommended metal mask patterns. Please use them as a reference.

1) Without soldering terminals
Socket
Recommended PC board pattern (TOP VIEW)



Recommended metal mask pattern
Metal mask thickness: When 150 μm
(Opening area ratio: 40%)



Recommended metal mask pattern
Metal mask thickness: When 120 μm
(Opening area ratio: 50%)



Header
Recommended PC board pattern (TOP VIEW)



Recommended metal mask pattern
Metal mask thickness: When 150 μm
(Opening area ratio: 32%)

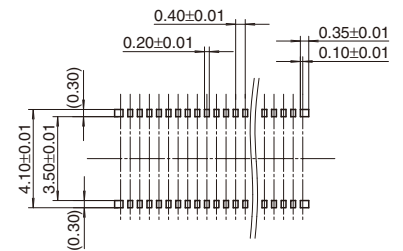

Recommended metal mask pattern
Metal mask thickness: When 120 μm
(Opening area ratio: 40%)

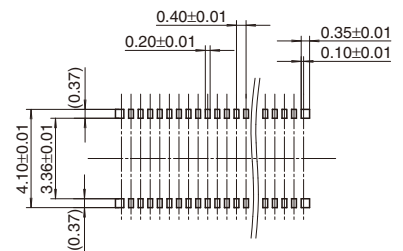

2) With soldering terminals

Socket

Recommended PC board pattern (TOP VIEW)

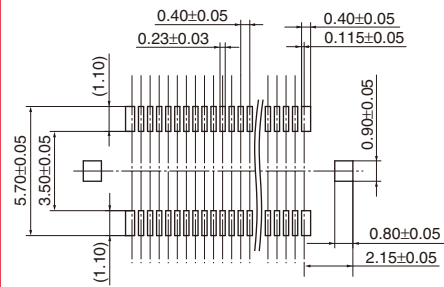

Recommended metal mask pattern

Metal mask thickness: When 150 μm
(Terminal portion opening area ratio: 40%)
(Metal portion opening area ratio: 65%)

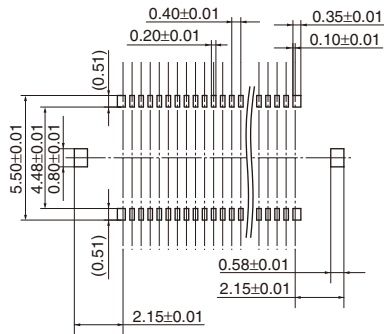

Recommended metal mask pattern

Metal mask thickness: When 120 μm
(Terminal portion opening area ratio: 50%)
(Metal portion opening area ratio: 80%)

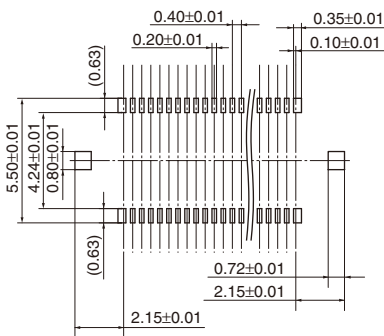

Header

Recommended PC board pattern (TOP VIEW)

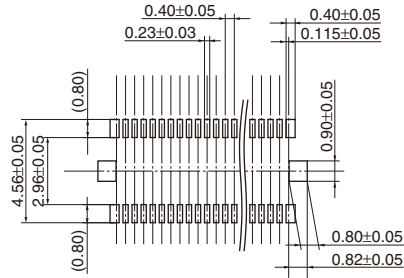

Recommended metal mask pattern

Metal mask thickness: When 150 μm
(Terminal portion opening area ratio: 32%)
(Metal portion opening area ratio: 65%)

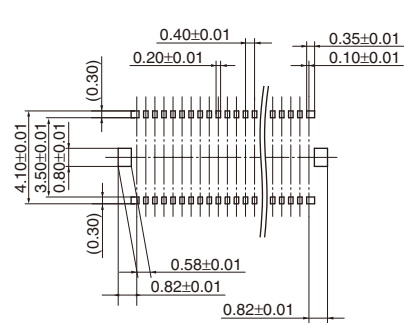

Recommended metal mask pattern

Metal mask thickness: When 120 μm
(Terminal portion opening area ratio: 40%)
(Metal portion opening area ratio: 80%)

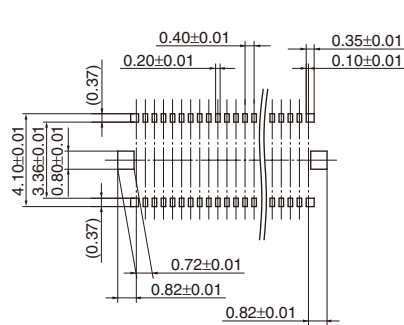

Please refer to the latest product specifications when designing your product.

Notes on Using Narrow pitch Connectors/ High Current Connectors

About safety remarks

Observe the following safety remarks to prevent accidents and injuries.

- 1) Do not use these connectors beyond the specification sheets. The usage outside of specified rated current, dielectric strength, and environmental conditions and so on may cause circuitry damage via abnormal heating, smoke, and fire.
- 2) In order to avoid accidents, your thorough specification review is appreciated. Please contact our sales office if your usage is out of the specifications. Otherwise, Panasonic Corporation cannot guarantee the quality and reliability.

- 3) Panasonic Corporation is consistently striving to improve quality and reliability. However, the fact remains that electrical components and devices generally cause failures at a given statistical probability. Furthermore, their durability varies with use environments or use conditions. In this respect, please check for actual electrical components and devices under actual conditions before use. Continued usage in a state of degraded condition may cause the deteriorated insulation, thus result in abnormal heat, smoke or firing. Please carry out safety design and periodic maintenance including redundancy design, design for fire spread prevention, and design for malfunction prevention so that no accidents resulting in injury or death, fire accidents, or social damage will be caused as a result of failure of the products or ending life of the products.

Regarding the design of devices and PC board patterns

- 1) When using the board to board connectors, do not connect a pair of board with multiple connectors. Otherwise, misaligned connector positions may cause mating failure or product breakage.
- 2) With mounting equipment, there may be up to a ± 0.2 to 0.3 mm error in positioning. Be sure to design PC boards and patterns while taking into consideration the performance and abilities of the required equipment.
- 3) Some connectors have tabs embossed on the body to aid in positioning. When using these connectors, make sure that the PC board is designed with positioning holes to match these tabs.
- 4) To ensure the required mechanical strength when soldering the connector terminals, make sure the PC board meets recommended PC board pattern design dimensions given.
- 5) PC board
Control the thicknesses of the cover lay and adhesive to prevent poor soldering. This connector has no stand-off. Therefore, minimize the thickness of the cover lay, etc. so as to prevent the occurrence of poor soldering.
- 6) For all connectors of the narrow pitch series, to prevent the PC board from coming off during vibrations or impacts, and to prevent loads from falling directly on the soldered portions, be sure to design some means to fix the PC board in place.
Example) Secure in place with screws

- 7) When mounting connectors on a FPC
 - When the connector soldered to FPC is mated or unmated, solder detachment may occur by the force to the terminals. Connector handling is recommended in the condition when the reinforcing plate is attached to the backside of FPC where the connector is mounted. The external dimension of the reinforcing plate is recommended to be larger than the dimension of "Recommended PC board pattern" (extended dimension of one side is approximately 0.5 to 1.0 mm). The materials and thickness of the reinforcing plate are glass epoxy or polyimide (thickness 0.2 to 0.3 mm) or SUS (thickness 0.1 to 0.2 mm).
 - As this connector has temporary locking structure, the connector mating may be separated by the dropping impact depend on the size, weight or bending force of the FPC. Please consider the measures at usage to prevent the mating separation.
- 8) The narrow pitch connector series is designed to be compact and thin. Although ease of handling has been taken into account, take care when mating the connectors, as displacement or angled mating could damage or deform the connector.



When connecting PC boards, take appropriate measures to prevent the connector from coming off.

Regarding the selection of the connector placement machine and the mounting procedures

- 1) Select the placement machine taking into consideration the connector height, required positioning accuracy, and packaging conditions.
- 2) Be aware that if the chucking force of the placement machine is too great, it may deform the shape of the connector body or connector terminals.
- 3) Be aware that during mounting, external forces may be applied to the connector contact surfaces and terminals and cause deformations.
- 4) Depending on the size of the connector being used, self alignment may not be possible. In such cases, be sure to carefully position the terminal with the PC board pattern.

- 5) The positioning bosses give an approximate alignment for positioning on the PC board. For accurate positioning of the connector when mounting it to the PC board, we recommend using an automatic positioning machine.
- 6) In case of dry condition, please note the occurrence of static electricity. The product may be adhered to the embossed carrier tape or the cover tape in dry condition. Recommended humidity is from 40 to 60%RH and please remove static electricity by ionizer in manufacturing process.

Regarding soldering

Reflow soldering

- 1) Measure the recommended profile temperature for reflow soldering by placing a sensor on the PC board near the connector surface or terminals. (Please refer to the specification for detail because the temperature setting differs by products.)
- 2) As for cream solder printing, screen printing is recommended.
- 3) When setting the screen opening area and PC board foot pattern area, refer the recommended PC board pattern and window size of metal mask on the specification sheet, and make sure that the size of board pattern and metal mask at the base of the terminals are not increased.
- 4) Please pay attentions not to provide too much solder. It makes miss mating because of interference at soldering portion when mating.



- 5) When mounting on both sides of the PC board and the connector is mounting on the underside, use adhesives or other means to ensure the connector is properly fixed to the PC board. (Double reflow soldering on the same side is possible.)
- 6) The condition of solder or flux rise and wettability varies depending on the type of solder and flux. Solder and flux characteristics should be taken into consideration and also set the reflow temperature and oxygen level.

- 7) Do not use resin-containing solder. Otherwise, the contacts might be firmly fixed.
- 8) Soldering conditions
Please use the reflow temperature profile conditions recommended below for reflow soldering. Please contact our sales office before using a temperature profile other than that described below (e.g. lead-free solder)



For products other than the ones above, please refer to the latest product specifications.

- 9) The temperature profiles given in this catalog are values measured when using the connector on a resin-based PC board. When performed reflow soldering on a metal board (iron, aluminum, etc.) or a metal table to mount on a FPC, make sure there is no deformation or discoloration of the connector before mounting.
- 10) Please contact our sales office when using a screen-printing thickness other than that recommended.

Hand soldering

- 1) Set the soldering iron so that the tip temperature is less than that given in the table below.

Table A

Product name	Soldering iron temperature
SMD type connectors all products	300°C within 5 sec. 350°C within 3 sec.

- 2) Do not allow flux to spread onto the connector leads or PC board. This may lead to flux rising up to the connector inside.
- 3) Touch the soldering iron to the foot pattern. After the foot pattern and connector terminal are heated, apply the solder wire so it melts at the end of the connector terminals.



- 4) Be aware that soldering while applying a load on the connector terminals may cause improper operation of the connector.
- 5) Thoroughly clean the soldering iron.
- 6) Flux from the solder wire may get on the contact surfaces during soldering operations. After soldering, carefully check the contact surfaces and clean off any solder before use.
- 7) These connector is low profile type. If too much solder is supplied for hand soldering, It makes miss mating because of interference at soldering portion. Please pay attentions.

Solder reworking

- 1) Finish reworking in one operation.
- 2) In case of soldering rework of bridges. Do not use supplementary solder flux. Doing so may cause contact problems by flux.
- 3) Keep the soldering iron tip temperature below the temperature given in Table A.

Handling single components

- 1) Make sure not to drop or allow parts to fall from work bench.
- 2) Excessive force applied to the terminals could cause warping, come out, or weaken the adhesive strength of the solder. Handle with care.

- 3) Do not insert or remove the connector when it is not soldered. Forcibly applied external pressure on the terminals can weaken the adherence of the terminals to the molded part or cause the terminals to lose their evenness.

Precautions for mating

This product is designed with ease of handling. However, in order to prevent the deformation or damage of contacts and molding, take care and do not mate the connectors as shown right.



Cleaning flux from PC board

There is no need to clean this product. If cleaning it, pay attention to the following points to prevent the negative effect to the product.

- 1) Keep the cleaning solvent clean and prevent the connector contacts from contamination.
- 2) Some cleaning solvents are strong and they may dissolve the molded part and characters, so pure water passed liquid solvent is recommended.

Handling the PC board

Handling the PC board after mounting the connector

When cutting or bending the PC board after mounting the connector, be careful that the soldered sections are subjected to excessive force.

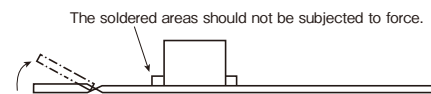

Storage of connectors

- 1) To prevent problems from voids or air pockets due to heat of reflow soldering, avoid storing the connectors in areas of high humidity.
- 2) Depending on the connector type, the color of the connector may vary from connector to connector depending on when it is produced. Some connectors may change color slightly if subjected to ultraviolet rays during storage. This is normal and will not affect the operation of the connector.

- 3) When storing the connectors with the PC boards assembled and components already set, be careful not to stack them up so the connectors are subjected to excessive forces.
- 4) Avoid storing the connectors in locations with excessive dust. The dust may accumulate and cause improper connections at the contact surfaces.

Other Notes

- 1) Do not remove or insert the electrified connector (in the state of carrying current or applying voltage).
- 2) Dropping of the products or rough mishandling may bend or damage the terminals and possibly hinder proper reflow soldering.
- 3) Before soldering, try not to insert or remove the connector more than absolutely necessary.

- 4) When coating the PC board after soldering the connector to prevent the deterioration of insulation, perform the coating in such a way so that the coating does not get on the connector.
- 5) There may be variations in the colors of products from different production lots. This is normal.
- 6) The connectors are not meant to be used for switching.
- 7) Product failures due to condensation are not covered by warranty.

Regarding sample orders to confirm proper mounting

When ordering samples to confirm proper mounting with the placement machine, connectors are delivered in 50-piece units in the condition given right. Consult a sale representative for ordering sample units.

Condition when delivered from manufacturing



Embossed tape amount required for the mounting

Required number of products for sample production (Unit 50 pcs.)



Please refer to the latest product specifications when designing your product.

Please contact

Panasonic Corporation

Electromechanical Control Business Division



■ 1006, Oaza Kadoma, Kadoma-shi, Osaka 571-8506, Japan
industrial.panasonic.com/ac/e/

Panasonic®

©Panasonic Corporation 2018

Looking for pricing, stock, or lifecycle information?

Click below to explore more details on WIN SOURCE:

-  [View AXK750247G on WIN SOURCE](#)
-  [Panasonic Information](#)

Optimize Your Supply Chain with WIN SOURCE Solutions

-  Global Sourcing Solution
-  Obsolete Management
-  Cost Control Management
-  Shortage Management
-  Alternative Solution
-  Excess Inventory Management