

1. Overview

1.1 Features

The R8C/36C Group of single-chip MCUs incorporates the R8C CPU core, employing sophisticated instructions for a high level of efficiency. With 1 Mbyte of address space, and it is capable of executing instructions at high speed. In addition, the CPU core boasts a multiplier for high-speed operation processing.

Power consumption is low, and the supported operating modes allow additional power control. These MCUs are designed to maximize EMI/EMS performance.

Integration of many peripheral functions, including multifunction timer and serial interface, reduces the number of system components.

The R8C/36C Group has data flash (1 KB × 4 blocks) with the background operation (BGO) function.

1.1.1 Applications

Electronic household appliances, office equipment, audio equipment, consumer equipment, etc.

1.1.2 Specifications

Tables 1.1 and 1.2 outline the Specifications for R8C/36C Group.

Table 1.1 Specifications for R8C/36C Group (1)

| Item | Function | Specification |
|--------------------------------|---------------------------|--|
| CPU | Central processing unit | R8C CPU core <ul style="list-style-type: none"> • Number of fundamental instructions: 89 • Minimum instruction execution time: <ul style="list-style-type: none"> 50 ns ($f(XIN) = 20$ MHz, $VCC = 2.7$ to 5.5 V) 200 ns ($f(XIN) = 5$ MHz, $VCC = 1.8$ to 5.5 V) • Multiplier: 16 bits \times 16 bits \rightarrow 32 bits • Multiply-accumulate instruction: 16 bits \times 16 bits + 32 bits \rightarrow 32 bits • Operation mode: Single-chip mode (address space: 1 Mbyte) |
| Memory | ROM, RAM, Data flash | Refer to Table 1.3 Product List for R8C/36C Group |
| Power Supply Voltage Detection | Voltage detection circuit | <ul style="list-style-type: none"> • Power-on reset • Voltage detection 3 (detection level of voltage detection 0 and voltage detection 1 selectable) |
| I/O Ports | Programmable I/O ports | <ul style="list-style-type: none"> • Input-only: 1 pin • CMOS I/O ports: 59, selectable pull-up resistor • High current drive ports: 59 |
| Clock | Clock generation circuits | <ul style="list-style-type: none"> • 4 circuits: XIN clock oscillation circuit, XCIN clock oscillation circuit (32 kHz), High-speed on-chip oscillator (with frequency adjustment function), Low-speed on-chip oscillator • Oscillation stop detection: XIN clock oscillation stop detection function • Frequency divider circuit: Dividing selectable 1, 2, 4, 8, and 16 • Low power consumption modes: <ul style="list-style-type: none"> Standard operating mode (high-speed clock, low-speed clock, high-speed on-chip oscillator, low-speed on-chip oscillator), wait mode, stop mode |
| | | Real-time clock (timer RE) |
| Interrupts | | <ul style="list-style-type: none"> • Interrupt Vectors: 69 • External: 9 sources ($\overline{INT} \times 5$, key input $\times 4$) • Priority levels: 7 levels |
| Watchdog Timer | | <ul style="list-style-type: none"> • 14 bits \times 1 (with prescaler) • Reset start selectable • Low-speed on-chip oscillator for watchdog timer selectable |
| DTC (Data Transfer Controller) | | <ul style="list-style-type: none"> • 1 channel • Activation sources: 39 • Transfer modes: 2 (normal mode, repeat mode) |
| Timer | Timer RA | 8 bits \times 1 (with 8-bit prescaler) Timer mode (period timer), pulse output mode (output level inverted every period), event counter mode, pulse width measurement mode, pulse period measurement mode |
| | Timer RB | 8 bits \times 1 (with 8-bit prescaler) Timer mode (period timer), programmable waveform generation mode (PWM output), programmable one-shot generation mode, programmable wait one-shot generation mode |
| | Timer RC | 16 bits \times 1 (with 4 capture/compare registers) Timer mode (input capture function, output compare function), PWM mode (output 3 pins), PWM2 mode (PWM output pin) |
| | Timer RD | 16 bits \times 2 (with 4 capture/compare registers) Timer mode (input capture function, output compare function), PWM mode (output 6 pins), reset synchronous PWM mode (output three-phase waveforms (6 pins), sawtooth wave modulation), complementary PWM mode (output three-phase waveforms (6 pins), triangular wave modulation), PWM3 mode (PWM output 2 pins with fixed period) |

Table 1.2 Specifications for R8C/36C Group (2)

| Item | Function | Specification |
|---|--------------|---|
| Timer | Timer RE | 8 bits × 1 Real-time clock mode (count seconds, minutes, hours, days of week), output compare mode |
| | Timer RF | 16 bits × 1 Input capture mode (input capture circuit), output compare mode (output compare circuit) |
| | Timer RG | 16 bits × 1 (with 2 capture/compare registers) Timer mode (input capture function, output compare function), PWM mode (output 1 pin), phase counting mode (available automatic measurement for the counts of 2-phase encoder) |
| Serial Interface | UART0, UART1 | Clock synchronous serial I/O/UART × 2 channel |
| | UART2 | Clock synchronous serial I/O, UART, I ² C mode (I ² C bus), multiprocessor communication function |
| Synchronous Serial Communication Unit (SSU) | | 1 (shared with I ² C bus) |
| I ² C bus | | 1 (shared with SSU) |
| LIN Module | | Hardware LIN: 1 (timer RA, UART0) |
| A/D Converter | | 10-bit resolution × 12 channels, includes sample and hold function, with sweep mode |
| D/A Converter | | 8-bit resolution × 2 circuits |
| Comparator B | | 2 circuits |
| Flash Memory | | <ul style="list-style-type: none"> • Programming and erasure voltage: VCC = 2.7 to 5.5 V • Programming and erasure endurance: 10,000 times (data flash) 1,000 times (program ROM) • Program security: ROM code protect, ID code check • Debug functions: On-chip debug, on-board flash rewrite function • Background operation (BGO) function (data flash) |
| Operating Frequency/Supply Voltage | | f(XIN) = 20 MHz (VCC = 2.7 to 5.5 V) f(XIN) = 5 MHz (VCC = 1.8 to 5.5 V) |
| Current consumption | | Typ. 7.0 mA (VCC = 5.0 V, f(XIN) = 20 MHz) Typ. 3.5 mA (VCC = 3.0 V, f(XIN) = 10 MHz) Typ. 4.0 μA (VCC = 3.0 V, wait mode (f(XCIN) = 32 kHz)) Typ. 2.0 μA (VCC = 3.0 V, stop mode) |
| Operating Ambient Temperature | | −20 to 85°C (N version) −40 to 85°C (D version) ⁽¹⁾ |
| Package | | 64-pin LQFP <ul style="list-style-type: none"> • Package code: PLQP0064KB-A (previous code: 64P6Q-A) • Package code: PLQP0064GA-A (previous code: 64P6U-A) 64-pin TQFP <ul style="list-style-type: none"> • Package code: PTQP0064LB-A |

Note:

1. Specify the D version if D version functions are to be used.

1.2 Product List

Tables 1.3 and 1.4 list Product List for R8C/36C Group. Figure 1.1 shows a Part Number, Memory Size, and Package of R8C/36C Group.

Table 1.3 Product List for R8C/36C Group (1)

Current of Nov 2010

| Part No. | ROM Capacity | | RAM Capacity | Package Type | Remarks | |
|---------------------|--------------|-------------|--------------|--------------|--|--|
| | Program ROM | Data flash | | | | |
| R5F21364CNFP | 16 Kbytes | 1 Kbyte × 4 | 1.5 Kbytes | PLQP0064KB-A | N version | |
| R5F21365CNFP | 24 Kbytes | 1 Kbyte × 4 | 2 Kbytes | PLQP0064KB-A | | |
| R5F21366CNFP | 32 Kbytes | 1 Kbyte × 4 | 2.5 Kbytes | PLQP0064KB-A | | |
| R5F21367CNFP | 48 Kbytes | 1 Kbyte × 4 | 4 Kbytes | PLQP0064KB-A | | |
| R5F21368CNFP | 64 Kbytes | 1 Kbyte × 4 | 6 Kbytes | PLQP0064KB-A | | |
| R5F2136ACNFP | 96 Kbytes | 1 Kbyte × 4 | 8 Kbytes | PLQP0064KB-A | | |
| R5F2136CCNFP | 128 Kbytes | 1 Kbyte × 4 | 10 Kbytes | PLQP0064KB-A | | |
| R5F21364CNFA | 16 Kbytes | 1 Kbyte × 4 | 1.5 Kbytes | PLQP0064GA-A | | |
| R5F21365CNFA | 24 Kbytes | 1 Kbyte × 4 | 2 Kbytes | PLQP0064GA-A | | |
| R5F21366CNFA | 32 Kbytes | 1 Kbyte × 4 | 2.5 Kbytes | PLQP0064GA-A | | |
| R5F21367CNFA | 48 Kbytes | 1 Kbyte × 4 | 4 Kbytes | PLQP0064GA-A | | |
| R5F21368CNFA | 64 Kbytes | 1 Kbyte × 4 | 6 Kbytes | PLQP0064GA-A | | |
| R5F2136ACNFA | 96 Kbytes | 1 Kbyte × 4 | 8 Kbytes | PLQP0064GA-A | | |
| R5F2136CCNFA | 128 Kbytes | 1 Kbyte × 4 | 10 Kbytes | PLQP0064GA-A | | |
| R5F21364CNFB (D) | 16 Kbytes | 1 Kbyte × 4 | 1.5 Kbytes | PTQP0064LB-A | | |
| R5F21365CNFB (D) | 24 Kbytes | 1 Kbyte × 4 | 2 Kbytes | PTQP0064LB-A | | |
| R5F21366CNFB (D) | 32 Kbytes | 1 Kbyte × 4 | 2.5 Kbytes | PTQP0064LB-A | | |
| R5F21367CNFB (D) | 48 Kbytes | 1 Kbyte × 4 | 4 Kbytes | PTQP0064LB-A | | |
| R5F21368CNFB (D) | 64 Kbytes | 1 Kbyte × 4 | 6 Kbytes | PTQP0064LB-A | | |
| R5F2136ACNFB (D) | 96 Kbytes | 1 Kbyte × 4 | 8 Kbytes | PTQP0064LB-A | | |
| R5F2136CCNFB (D) | 128 Kbytes | 1 Kbyte × 4 | 10 Kbytes | PTQP0064LB-A | | |
| R5F21364CNXXXFP | 16 Kbytes | 1 Kbyte × 4 | 1.5 Kbytes | PLQP0064KB-A | N version Factory programming product (1) | |
| R5F21365CNXXXFP | 24 Kbytes | 1 Kbyte × 4 | 2 Kbytes | PLQP0064KB-A | | |
| R5F21366CNXXXFP | 32 Kbytes | 1 Kbyte × 4 | 2.5 Kbytes | PLQP0064KB-A | | |
| R5F21367CNXXXFP | 48 Kbytes | 1 Kbyte × 4 | 4 Kbytes | PLQP0064KB-A | | |
| R5F21368CNXXXFP | 64 Kbytes | 1 Kbyte × 4 | 6 Kbytes | PLQP0064KB-A | | |
| R5F2136ACNXXXFP | 96 Kbytes | 1 Kbyte × 4 | 8 Kbytes | PLQP0064KB-A | | |
| R5F2136CCNXXXFP | 128 Kbytes | 1 Kbyte × 4 | 10 Kbytes | PLQP0064KB-A | | |
| R5F21364CNXXXFA | 16 Kbytes | 1 Kbyte × 4 | 1.5 Kbytes | PLQP0064GA-A | | |
| R5F21365CNXXXFA | 24 Kbytes | 1 Kbyte × 4 | 2 Kbytes | PLQP0064GA-A | | |
| R5F21366CNXXXFA | 32 Kbytes | 1 Kbyte × 4 | 2.5 Kbytes | PLQP0064GA-A | | |
| R5F21367CNXXXFA | 48 Kbytes | 1 Kbyte × 4 | 4 Kbytes | PLQP0064GA-A | | |
| R5F21368CNXXXFA | 64 Kbytes | 1 Kbyte × 4 | 6 Kbytes | PLQP0064GA-A | | |
| R5F2136ACNXXXFA | 96 Kbytes | 1 Kbyte × 4 | 8 Kbytes | PLQP0064GA-A | | |
| R5F2136CCNXXXFA | 128 Kbytes | 1 Kbyte × 4 | 10 Kbytes | PLQP0064GA-A | | |
| R5F21364CNXXXFB (D) | 16 Kbytes | 1 Kbyte × 4 | 1.5 Kbytes | PTQP0064LB-A | | |
| R5F21365CNXXXFB (D) | 24 Kbytes | 1 Kbyte × 4 | 2 Kbytes | PTQP0064LB-A | | |
| R5F21366CNXXXFB (D) | 32 Kbytes | 1 Kbyte × 4 | 2.5 Kbytes | PTQP0064LB-A | | |
| R5F21367CNXXXFB (D) | 48 Kbytes | 1 Kbyte × 4 | 4 Kbytes | PTQP0064LB-A | | |
| R5F21368CNXXXFB (D) | 64 Kbytes | 1 Kbyte × 4 | 6 Kbytes | PTQP0064LB-A | | |
| R5F2136ACNXXXFB (D) | 96 Kbytes | 1 Kbyte × 4 | 8 Kbytes | PTQP0064LB-A | | |
| R5F2136CCNXXXFB (D) | 128 Kbytes | 1 Kbyte × 4 | 10 Kbytes | PTQP0064LB-A | | |

(D): Under development

Note:

1. The user ROM is programmed before shipment.

Table 1.4 Product List for R8C/36C Group (2)

Current of Nov 2010

| Part No. | ROM Capacity | | RAM Capacity | Package Type | Remarks | |
|---------------------|--------------|-------------|--------------|--------------|-----------|-----------------------------|
| | Program ROM | Data flash | | | | |
| R5F21364CDFP | 16 Kbytes | 1 Kbyte × 4 | 1.5 Kbytes | PLQP0064KB-A | D version | |
| R5F21365CDFP | 24 Kbytes | 1 Kbyte × 4 | 2 Kbytes | PLQP0064KB-A | | |
| R5F21366CDFP | 32 Kbytes | 1 Kbyte × 4 | 2.5 Kbytes | PLQP0064KB-A | | |
| R5F21367CDFP | 48 Kbytes | 1 Kbyte × 4 | 4 Kbytes | PLQP0064KB-A | | |
| R5F21368CDFP | 64 Kbytes | 1 Kbyte × 4 | 6 Kbytes | PLQP0064KB-A | | |
| R5F2136ACDFP | 96 Kbytes | 1 Kbyte × 4 | 8 Kbytes | PLQP0064KB-A | | |
| R5F2136CCDFP | 128 Kbytes | 1 Kbyte × 4 | 10 Kbytes | PLQP0064KB-A | | |
| R5F21364CDFA | 16 Kbytes | 1 Kbyte × 4 | 1.5 Kbytes | PLQP0064GA-A | | |
| R5F21365CDFA | 24 Kbytes | 1 Kbyte × 4 | 2 Kbytes | PLQP0064GA-A | | |
| R5F21366CDFA | 32 Kbytes | 1 Kbyte × 4 | 2.5 Kbytes | PLQP0064GA-A | | |
| R5F21367CDFA | 48 Kbytes | 1 Kbyte × 4 | 4 Kbytes | PLQP0064GA-A | | |
| R5F21368CDFA | 64 Kbytes | 1 Kbyte × 4 | 6 Kbytes | PLQP0064GA-A | | |
| R5F2136ACDFA | 96 Kbytes | 1 Kbyte × 4 | 8 Kbytes | PLQP0064GA-A | | |
| R5F2136CCDFA | 128 Kbytes | 1 Kbyte × 4 | 10 Kbytes | PLQP0064GA-A | | |
| R5F21364CDFB (D) | 16 Kbytes | 1 Kbyte × 4 | 1.5 Kbytes | PTQP0064LB-A | | |
| R5F21365CDFB (D) | 24 Kbytes | 1 Kbyte × 4 | 2 Kbytes | PTQP0064LB-A | | |
| R5F21366CDFB (D) | 32 Kbytes | 1 Kbyte × 4 | 2.5 Kbytes | PTQP0064LB-A | | |
| R5F21367CDFB (D) | 48 Kbytes | 1 Kbyte × 4 | 4 Kbytes | PTQP0064LB-A | | |
| R5F21368CDFB (D) | 64 Kbytes | 1 Kbyte × 4 | 6 Kbytes | PTQP0064LB-A | | |
| R5F2136ACDFB (D) | 96 Kbytes | 1 Kbyte × 4 | 8 Kbytes | PTQP0064LB-A | | |
| R5F2136CCDFB (D) | 128 Kbytes | 1 Kbyte × 4 | 10 Kbytes | PTQP0064LB-A | | |
| R5F21364CDXXXFP | 16 Kbytes | 1 Kbyte × 4 | 1.5 Kbytes | PLQP0064KB-A | N version | Factory programming product |
| R5F21365CDXXXFP | 24 Kbytes | 1 Kbyte × 4 | 2 Kbytes | PLQP0064KB-A | | |
| R5F21366CDXXXFP | 32 Kbytes | 1 Kbyte × 4 | 2.5 Kbytes | PLQP0064KB-A | | |
| R5F21367CDXXXFP | 48 Kbytes | 1 Kbyte × 4 | 4 Kbytes | PLQP0064KB-A | | |
| R5F21368CDXXXFP | 64 Kbytes | 1 Kbyte × 4 | 6 Kbytes | PLQP0064KB-A | | |
| R5F2136ACDXXXFP | 96 Kbytes | 1 Kbyte × 4 | 8 Kbytes | PLQP0064KB-A | | |
| R5F2136CCDXXXFP | 128 Kbytes | 1 Kbyte × 4 | 10 Kbytes | PLQP0064KB-A | | |
| R5F21364CDXXXFA | 16 Kbytes | 1 Kbyte × 4 | 1.5 Kbytes | PLQP0064GA-A | | |
| R5F21365CDXXXFA | 24 Kbytes | 1 Kbyte × 4 | 2 Kbytes | PLQP0064GA-A | | |
| R5F21366CDXXXFA | 32 Kbytes | 1 Kbyte × 4 | 2.5 Kbytes | PLQP0064GA-A | | |
| R5F21367CDXXXFA | 48 Kbytes | 1 Kbyte × 4 | 4 Kbytes | PLQP0064GA-A | | |
| R5F21368CDXXXFA | 64 Kbytes | 1 Kbyte × 4 | 6 Kbytes | PLQP0064GA-A | | |
| R5F2136ACDXXXFA | 96 Kbytes | 1 Kbyte × 4 | 8 Kbytes | PLQP0064GA-A | | |
| R5F2136CCDXXXFA | 128 Kbytes | 1 Kbyte × 4 | 10 Kbytes | PLQP0064GA-A | | |
| R5F21364CDXXXFB (D) | 16 Kbytes | 1 Kbyte × 4 | 1.5 Kbytes | PTQP0064LB-A | | |
| R5F21365CDXXXFB (D) | 24 Kbytes | 1 Kbyte × 4 | 2 Kbytes | PTQP0064LB-A | | |
| R5F21366CDXXXFB (D) | 32 Kbytes | 1 Kbyte × 4 | 2.5 Kbytes | PTQP0064LB-A | | |
| R5F21367CDXXXFB (D) | 48 Kbytes | 1 Kbyte × 4 | 4 Kbytes | PTQP0064LB-A | | |
| R5F21368CDXXXFB (D) | 64 Kbytes | 1 Kbyte × 4 | 6 Kbytes | PTQP0064LB-A | | |
| R5F2136ACDXXXFB (D) | 96 Kbytes | 1 Kbyte × 4 | 8 Kbytes | PTQP0064LB-A | | |
| R5F2136CCDXXXFB (D) | 128 Kbytes | 1 Kbyte × 4 | 10 Kbytes | PTQP0064LB-A | | |

(D): Under development

Note:

1. The user ROM is programmed before shipment.

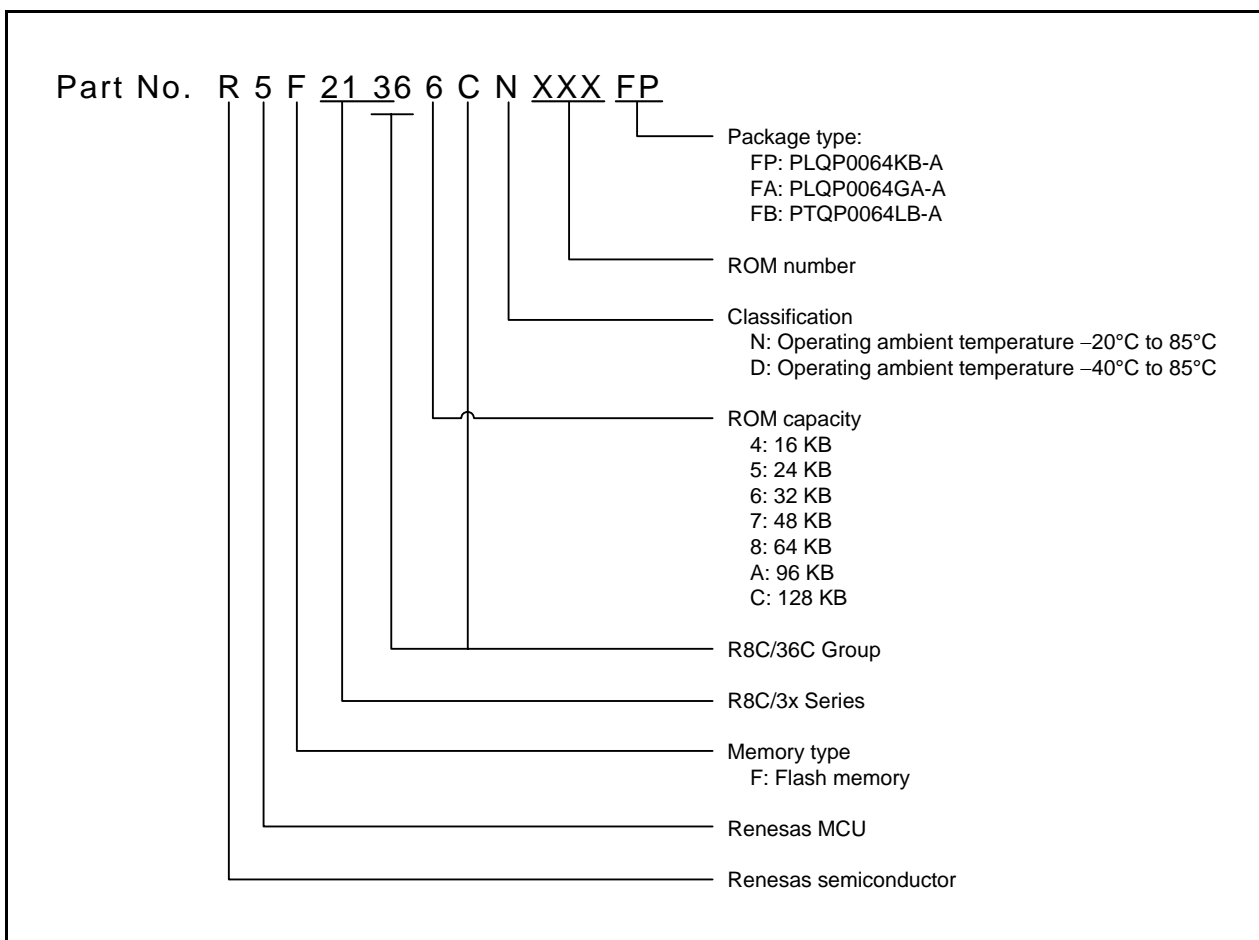

Figure 1.1 Part Number, Memory Size, and Package of R8C/36C Group

1.3 Block Diagram

Figure 1.2 shows a Block Diagram.

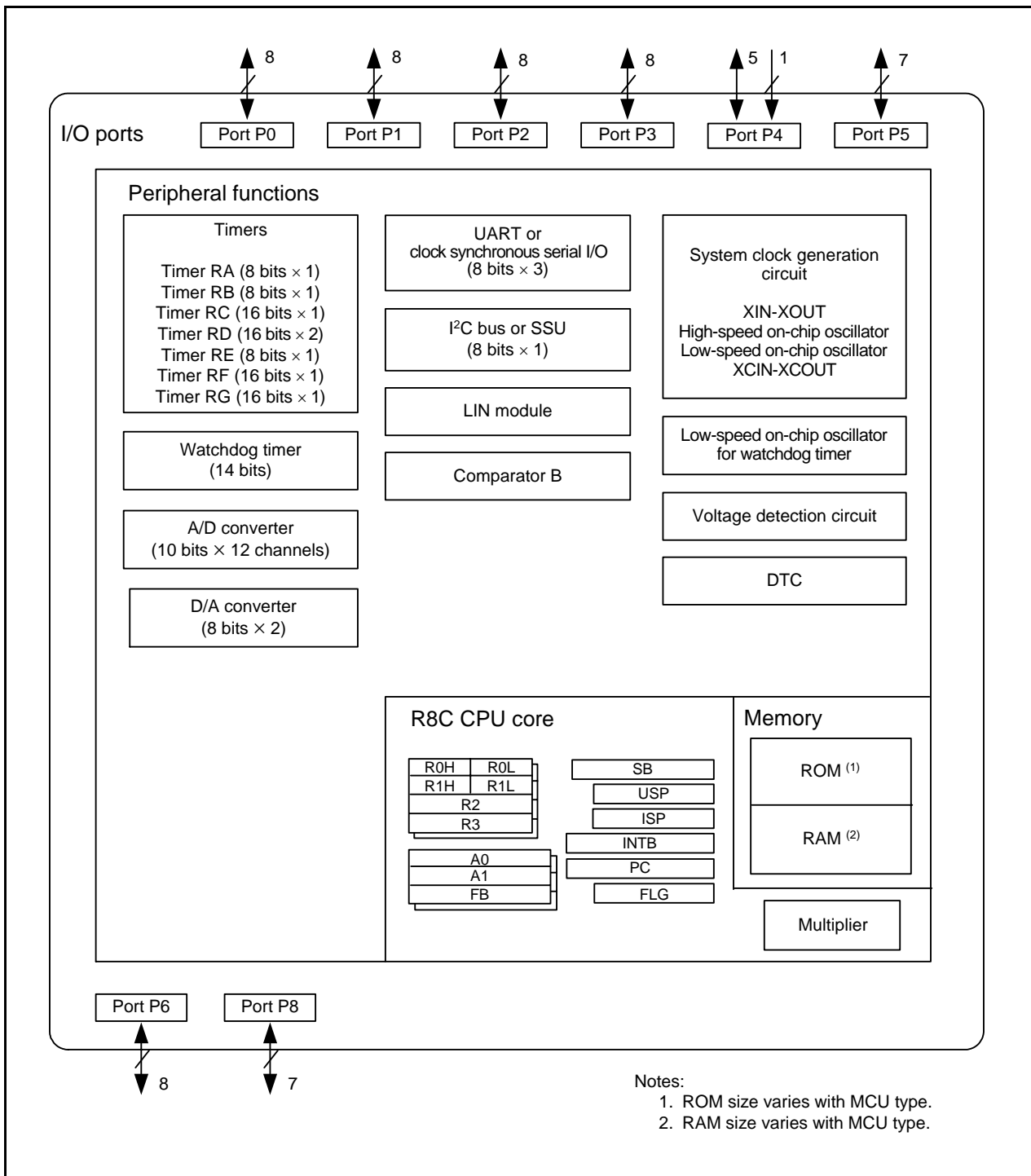

Figure 1.2 Block Diagram

1.4 Pin Assignment

Figure 1.3 shows Pin Assignment (Top View). Tables 1.5 and 1.6 outline the Pin Name Information by Pin Number.

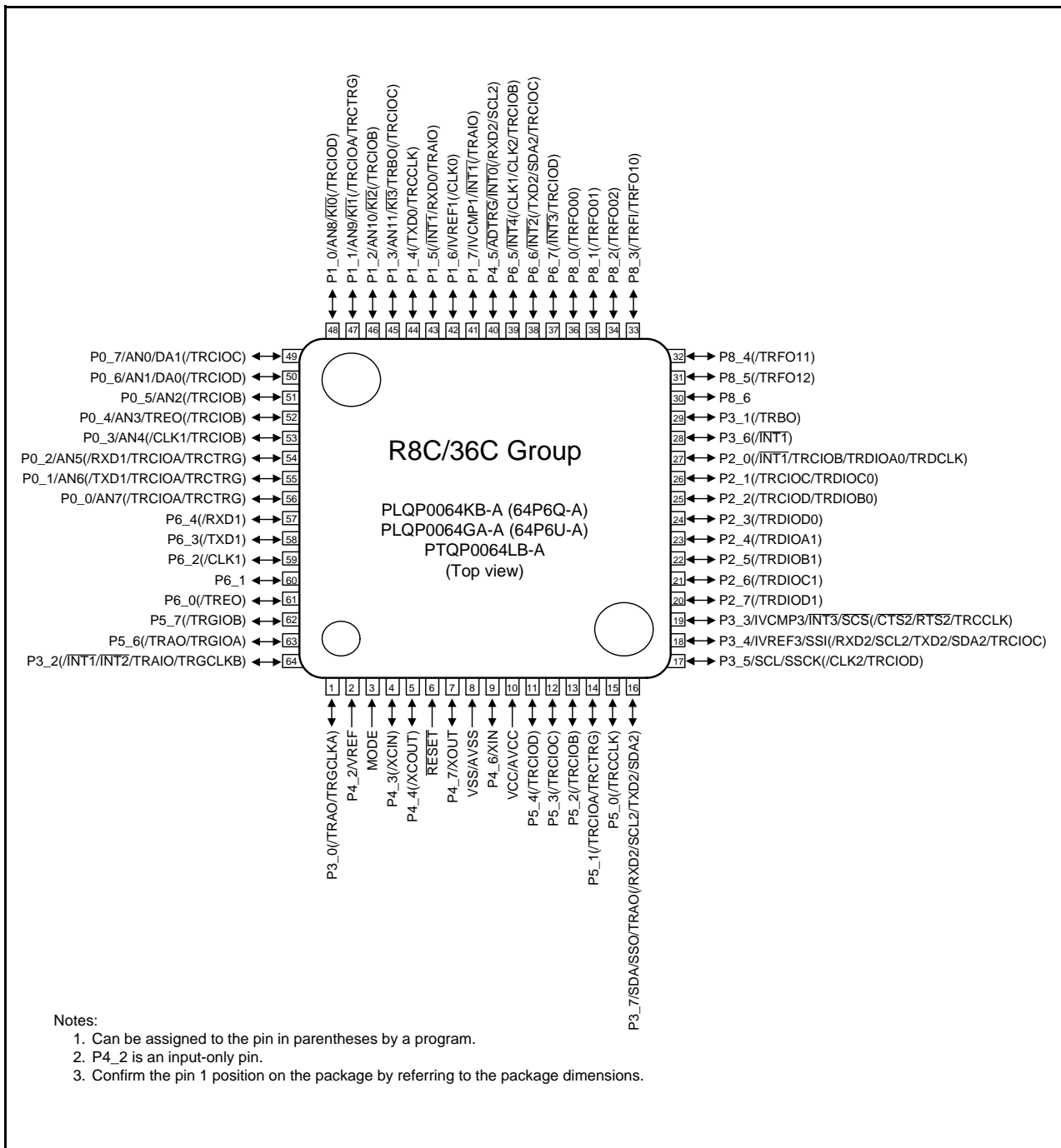

Figure 1.3 Pin Assignment (Top View)

Table 1.5 Pin Name Information by Pin Number (1)

| Pin Number | Control Pin | Port | I/O Pin Functions for Peripheral Modules | | | | | |
|------------|-------------|------|--|-----------------------------|---------------------------|------|----------------------|--|
| | | | Interrupt | Timer | Serial Interface | SSU | I ² C bus | A/D Converter, D/A Converter, Comparator B |
| 1 | | P3_0 | | (TRAO/TRGCLKA) | | | | |
| 2 | | P4_2 | | | | | | VREF |
| 3 | MODE | | | | | | | |
| 4 | (XCIN) | P4_3 | | | | | | |
| 5 | (XCOUT) | P4_4 | | | | | | |
| 6 | RESET | | | | | | | |
| 7 | XOUT | P4_7 | | | | | | |
| 8 | VSS/AVSS | | | | | | | |
| 9 | XIN | P4_6 | | | | | | |
| 10 | VCC/AVCC | | | | | | | |
| 11 | | P5_4 | | (TRCIOD) | | | | |
| 12 | | P5_3 | | (TRCIOC) | | | | |
| 13 | | P5_2 | | (TRCIOB) | | | | |
| 14 | | P5_1 | | (TRCIOA/TRCTRG) | | | | |
| 15 | | P5_0 | | (TRCCLK) | | | | |
| 16 | | P3_7 | | TRAO | (TXD2/SDA2/ RXD2/SCL2) | SSO | SDA | |
| 17 | | P3_5 | | (TRCIOD) | (CLK2) | SSCK | SCL | |
| 18 | | P3_4 | | (TRCIOC) | (TXD2/SDA2/ RXD2/SCL2) | SSI | | IVREF3 |
| 19 | | P3_3 | INT3 | (TRCCLK) | (CTS2/RTS2) | SCS | | IVCMP3 |
| 20 | | P2_7 | | (TRDIOD1) | | | | |
| 21 | | P2_6 | | (TRDIOC1) | | | | |
| 22 | | P2_5 | | (TRDIOB1) | | | | |
| 23 | | P2_4 | | (TRDIOA1) | | | | |
| 24 | | P2_3 | | (TRDIOD0) | | | | |
| 25 | | P2_2 | | (TRCIOD/TRDIOB0) | | | | |
| 26 | | P2_1 | | (TRCIOC/TRDIOC0) | | | | |
| 27 | | P2_0 | (INT1) | (TRCIOB/TRDIOA0/ TRDCLK) | | | | |
| 28 | | P3_6 | (INT1) | | | | | |
| 29 | | P3_1 | | (TRBO) | | | | |
| 30 | | P8_6 | | | | | | |
| 31 | | P8_5 | | (TRFO12) | | | | |
| 32 | | P8_4 | | (TRFO11) | | | | |
| 33 | | P8_3 | | (TRFI/TRFO10) | | | | |
| 34 | | P8_2 | | (TRFO02) | | | | |
| 35 | | P8_1 | | (TRFO01) | | | | |
| 36 | | P8_0 | | (TRFO00) | | | | |
| 37 | | P6_7 | (INT3) | (TRCIOD) | | | | |
| 38 | | P6_6 | INT2 | (TRCIOC) | (TXD2/SDA2) | | | |
| 39 | | P6_5 | INT4 | (TRCIOB) | (CLK2/CLK1) | | | |

Note:

1. Can be assigned to the pin in parentheses by a program.

Table 1.6 Pin Name Information by Pin Number (2)

| Pin Number | Control Pin | Port | I/O Pin Functions for Peripheral Modules | | | | | A/D Converter, D/A Converter, Comparator B |
|------------|-------------|------|--|-------------------|------------------|-----|----------------------|--|
| | | | Interrupt | Timer | Serial Interface | SSU | I ² C bus | |
| 40 | | P4_5 | INT0 | | (RXD2/SCL2) | | | ADTRG |
| 41 | | P1_7 | INT1 | (TRAIO) | | | | IVCMP1 |
| 42 | | P1_6 | | | (CLK0) | | | IVREF1 |
| 43 | | P1_5 | (INT1) | (TRAIO) | (RXD0) | | | |
| 44 | | P1_4 | | (TRCCLK) | (TXD0) | | | |
| 45 | | P1_3 | $\overline{KI3}$ | TRBO (/TRCIOC) | | | | AN11 |
| 46 | | P1_2 | $\overline{KI2}$ | (TRCIOB) | | | | AN10 |
| 47 | | P1_1 | KI1 | (TRCIOA/TRCTRG) | | | | AN9 |
| 48 | | P1_0 | KI0 | (TRCIOD) | | | | AN8 |
| 49 | | P0_7 | | (TRCIOC) | | | | AN0/DA1 |
| 50 | | P0_6 | | (TRCIOD) | | | | AN1/DA0 |
| 51 | | P0_5 | | (TRCIOB) | | | | AN2 |
| 52 | | P0_4 | | TREO(/TRCIOB) | | | | AN3 |
| 53 | | P0_3 | | (TRCIOB) | (CLK1) | | | AN4 |
| 54 | | P0_2 | | (TRCIOA/TRCTRG) | (RXD1) | | | AN5 |
| 55 | | P0_1 | | (TRCIOA/TRCTRG) | (TXD1) | | | AN6 |
| 56 | | P0_0 | | (TRCIOA/TRCTRG) | | | | AN7 |
| 57 | | P6_4 | | | (RXD1) | | | |
| 58 | | P6_3 | | | (TXD1) | | | |
| 59 | | P6_2 | | | (CLK1) | | | |
| 60 | | P6_1 | | | | | | |
| 61 | | P6_0 | | (TREO) | | | | |
| 62 | | P5_7 | | (TRGIOB) | | | | |
| 63 | | P5_6 | | (TRAO/TRGIOA) | | | | |
| 64 | | P3_2 | (INT1/ INT2) | (TRAIO/TRGCLKB) | | | | |

Note:

1. Can be assigned to the pin in parentheses by a program.

1.5 Pin Functions

Tables 1.7 and 1.8 list Pin Functions.

Table 1.7 Pin Functions (1)

| Item | Pin Name | I/O Type | Description |
|---|--|----------|--|
| Power supply input | VCC, VSS | — | Apply 1.8 to 5.5 V to the VCC pin. Apply 0 V to the VSS pin. |
| Analog power supply input | AVCC, AVSS | — | Power supply for the A/D converter. Connect a capacitor between AVCC and AVSS. |
| Reset input | $\overline{\text{RESET}}$ | I | Input "L" on this pin resets the MCU. |
| MODE | MODE | I | Connect this pin to VCC via a resistor. |
| XIN clock input | XIN | I | These pins are provided for XIN clock generation circuit I/O. Connect a ceramic resonator or a crystal oscillator between the XIN and XOUT pins. ⁽¹⁾ To use an external clock, input it to the XOUT pin and leave the XIN pin open. |
| XIN clock output | XOUT | I/O | |
| XCIN clock input | XCIN | I | These pins are provided for XCIN clock generation circuit I/O. Connect a crystal oscillator between the XCIN and XCOU pins. ⁽¹⁾ To use an external clock, input it to the XCIN pin and leave the XCOU pin open. |
| XCIN clock output | XCOU | O | |
| $\overline{\text{INT}}$ interrupt input | $\overline{\text{INT0}}$ to $\overline{\text{INT4}}$ | I | $\overline{\text{INT}}$ interrupt input pins. |
| Key input interrupt | $\overline{\text{KI0}}$ to $\overline{\text{KI3}}$ | I | Key input interrupt input pins. |
| Timer RA | TRAIO | I/O | Timer RA I/O pin. |
| | TRAO | O | Timer RA output pin. |
| Timer RB | TRBO | O | Timer RB output pin. |
| Timer RC | TRCCLK | I | External clock input pin. |
| | TRCTRG | I | External trigger input pin. |
| | TRCIOA, TRCIOB, TRCIOC, TRCIOD | I/O | Timer RC I/O pins. |
| Timer RD | TRDIOA0, TRDIOA1, TRDIOB0, TRDIOB1, TRDIOC0, TRDIOC1, TRDIOD0, TRDIOD1 | I/O | Timer RD I/O pins. |
| | TRDCLK | I | External clock input pin. |
| Timer RE | TREO | O | Divided clock output pin. |
| Timer RF | TRFO00, TRFO10, TRFO01, TRFO11, TRFO02, TRFO12 | O | Timer RF output pins. |
| | TRFI | I | Timer RF input pin. |
| Timer RG | TRGIOA, TRGIOB | I/O | Timer RG I/O ports. |
| | TRGCLKA, TRGCLKB | I | External clock input pins. |
| Serial interface | CLK0, CLK1, CLK2 | I/O | Transfer clock I/O pins. |
| | RXD0, RXD1, RXD2 | I | Serial data input pins. |
| | TXD0, TXD1, TXD2 | O | Serial data output pins. |
| | $\overline{\text{CTS2}}$ | I | Transmission control input pin. |
| | RTS2 | O | Reception control output pin. |
| | SCL2 | I/O | I ² C mode clock I/O pin. |
| | SDA2 | I/O | I ² C mode data I/O pin. |

I: Input O: Output I/O: Input and output

Note:

1. Refer to the oscillator manufacturer for oscillation characteristics.

Table 1.8 Pin Functions (2)

| Item | Pin Name | I/O Type | Description |
|-------------------------|--|----------|---|
| SSU | SSI | I/O | Data I/O pin. |
| | $\overline{\text{SCS}}$ | I/O | Chip-select signal I/O pin. |
| | SSCK | I/O | Clock I/O pin. |
| | SSO | I/O | Data I/O pin. |
| I ² C bus | SCL | I/O | Clock I/O pin |
| | SDA | I/O | Data I/O pin |
| Reference voltage input | VREF | I | Reference voltage input pin to A/D converter. |
| A/D converter | AN0 to AN11 | I | Analog input pins to A/D converter. |
| | $\overline{\text{ADTRG}}$ | I | AD external trigger input pin. |
| D/A converter | DA0, DA1 | O | D/A converter output pins. |
| Comparator B | IVCMP1, IVCMP3 | I | Comparator B analog voltage input pins. |
| | IVREF1, IVREF3 | I | Comparator B reference voltage input pins. |
| I/O port | P0_0 to P0_7, P1_0 to P1_7, P2_0 to P2_7, P3_0 to P3_7, P4_3 to P4_7, P5_0 to P5_4, P5_6, P5_7, P6_0 to P6_7, P8_0 to P8_6 | I/O | CMOS I/O ports. Each port has an I/O select direction register, allowing each pin in the port to be directed for input or output individually. Any port set to input can be set to use a pull-up resistor or not by a program. |
| Input port | P4_2 | I | Input-only port. |

I: Input O: Output I/O: Input and output

2. Central Processing Unit (CPU)

Figure 2.1 shows the CPU Registers. The CPU contains 13 registers. R0, R1, R2, R3, A0, A1, and FB configure a register bank. There are two sets of register bank.

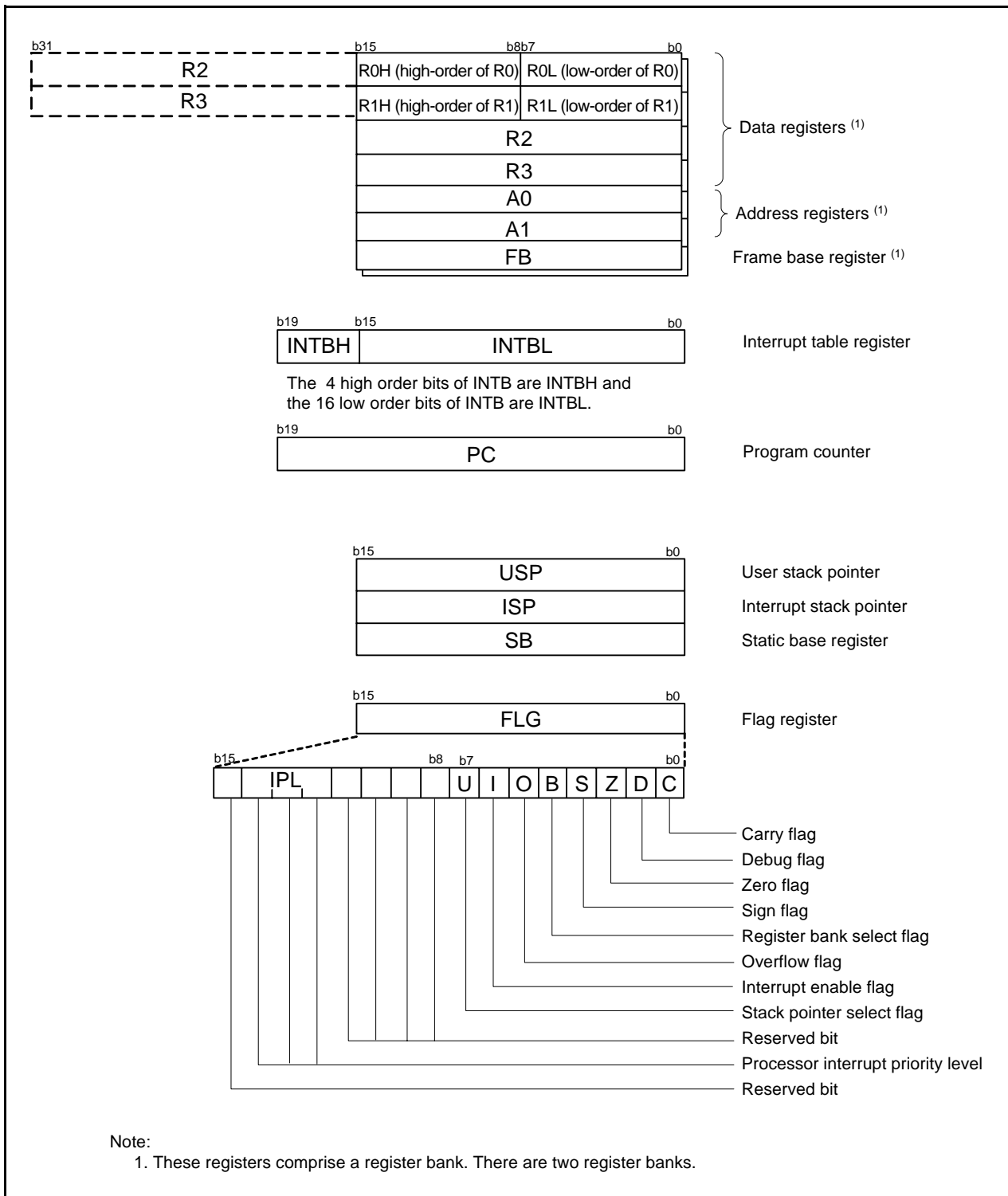

Figure 2.1 CPU Registers

2.1 Data Registers (R0, R1, R2, and R3)

R0 is a 16-bit register for transfer, arithmetic, and logic operations. The same applies to R1 to R3. R0 can be split into high-order bits (R0H) and low-order bits (R0L) to be used separately as 8-bit data registers. R1H and R1L are analogous to R0H and R0L. R2 can be combined with R0 and used as a 32-bit data register (R2R0). R3R1 is analogous to R2R0.

2.2 Address Registers (A0 and A1)

A0 is a 16-bit register for address register indirect addressing and address register relative addressing. It is also used for transfer, arithmetic, and logic operations. A1 is analogous to A0. A1 can be combined with A0 and as a 32-bit address register (A1A0).

2.3 Frame Base Register (FB)

FB is a 16-bit register for FB relative addressing.

2.4 Interrupt Table Register (INTB)

INTB is a 20-bit register that indicates the starting address of an interrupt vector table.

2.5 Program Counter (PC)

PC is 20 bits wide and indicates the address of the next instruction to be executed.

2.6 User Stack Pointer (USP) and Interrupt Stack Pointer (ISP)

The stack pointers (SP), USP and ISP, are each 16 bits wide. The U flag of FLG is used to switch between USP and ISP.

2.7 Static Base Register (SB)

SB is a 16-bit register for SB relative addressing.

2.8 Flag Register (FLG)

FLG is an 11-bit register indicating the CPU state.

2.8.1 Carry Flag (C)

The C flag retains carry, borrow, or shift-out bits that have been generated by the arithmetic and logic unit.

2.8.2 Debug Flag (D)

The D flag is for debugging only. Set it to 0.

2.8.3 Zero Flag (Z)

The Z flag is set to 1 when an arithmetic operation results in 0; otherwise to 0.

2.8.4 Sign Flag (S)

The S flag is set to 1 when an arithmetic operation results in a negative value; otherwise to 0.

2.8.5 Register Bank Select Flag (B)

Register bank 0 is selected when the B flag is 0. Register bank 1 is selected when this flag is set to 1.

2.8.6 Overflow Flag (O)

The O flag is set to 1 when an operation results in an overflow; otherwise to 0.

2.8.7 Interrupt Enable Flag (I)

The I flag enables maskable interrupts.

Interrupts are disabled when the I flag is set to 0, and are enabled when the I flag is set to 1. The I flag is set to 0 when an interrupt request is acknowledged.

2.8.8 Stack Pointer Select Flag (U)

ISP is selected when the U flag is set to 0; USP is selected when the U flag is set to 1.

The U flag is set to 0 when a hardware interrupt request is acknowledged or the INT instruction of software interrupt numbers 0 to 31 is executed.

2.8.9 Processor Interrupt Priority Level (IPL)

IPL is 3 bits wide and assigns processor interrupt priority levels from level 0 to level 7.

If a requested interrupt has higher priority than IPL, the interrupt is enabled.

2.8.10 Reserved Bit

If necessary, set to 0. When read, the content is undefined.

3. Memory

3.1 R8C/36C Group

Figure 3.1 is a Memory Map of R8C/36C Group. The R8C/36C Group has a 1-Mbyte address space from addresses 00000h to FFFFFh. The internal ROM (program ROM) is allocated lower addresses, beginning with address 0FFFFh. For example, a 64-Kbyte internal ROM area is allocated addresses 04000h to 13FFFh.

The fixed interrupt vector table is allocated addresses 0FFDCh to 0FFFFh. The starting address of each interrupt routine is stored here.

The internal ROM (data flash) is allocated addresses 03000h to 03FFFh.

The internal RAM is allocated higher addresses, beginning with address 00400h. For example, a 6-Kbyte internal RAM area is allocated addresses 00400h to 01BFFh. The internal RAM is used not only for data storage but also as a stack area when a subroutine is called or when an interrupt request is acknowledged.

Special function registers (SFRs) are allocated addresses 00000h to 002FFh and 02C00h to 02FFFh (the SFR areas for the DTC and other modules). Peripheral function control registers are allocated here. All unallocated spaces within the SFRs are reserved and cannot be accessed by users.

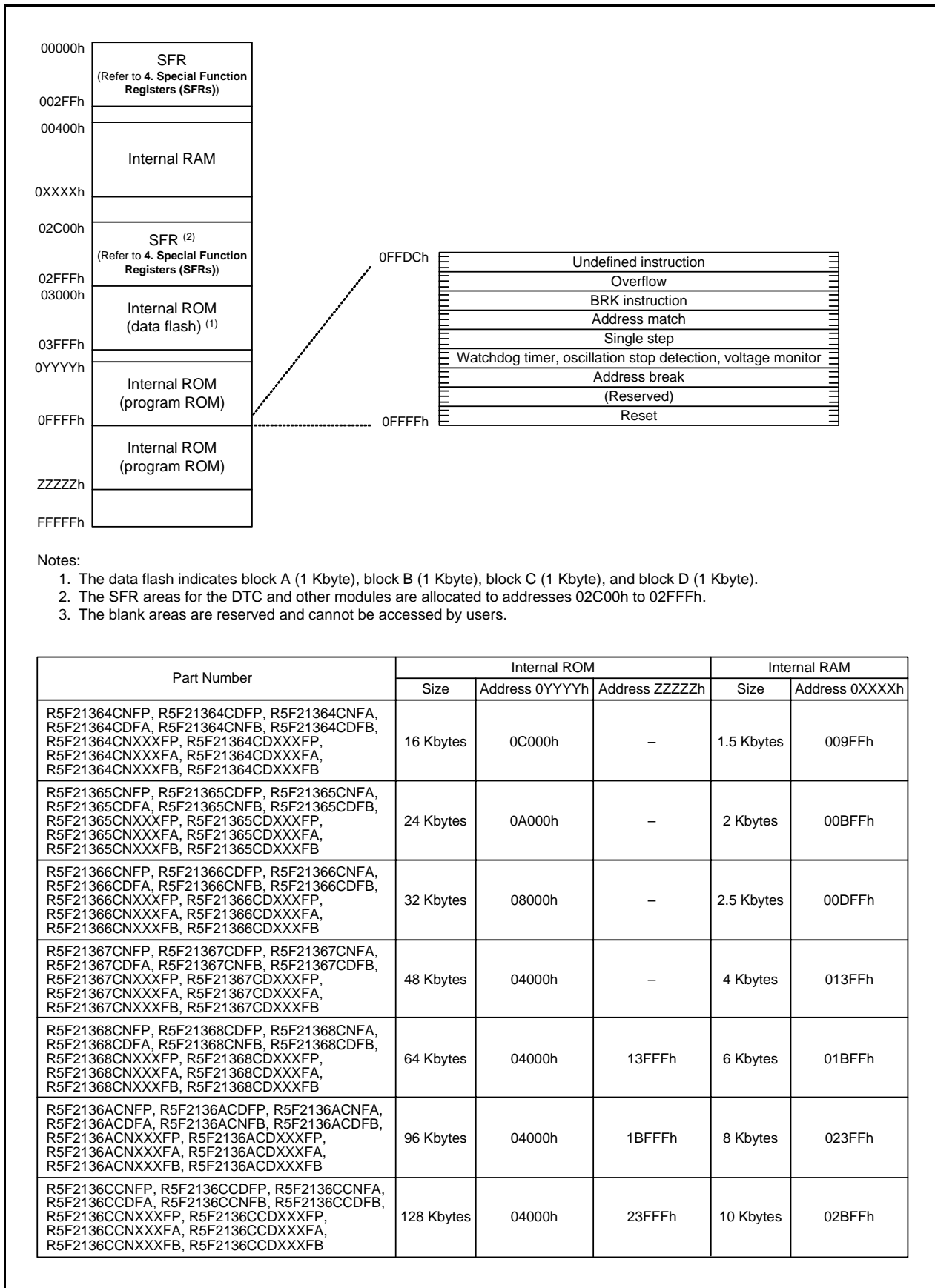

Figure 3.1 Memory Map of R8C/36C Group

4. Special Function Registers (SFRs)

An SFR (special function register) is a control register for a peripheral function. Tables 4.1 to 4.12 list the special function registers. Table 4.13 lists the ID Code Areas and Option Function Select Area.

Table 4.1 SFR Information (1) (1)

| Address | Register | Symbol | After Reset |
|---------|--|----------|--------------------------------|
| 0000h | | | |
| 0001h | | | |
| 0002h | | | |
| 0003h | | | |
| 0004h | Processor Mode Register 0 | PM0 | 00h |
| 0005h | Processor Mode Register 1 | PM1 | 00h |
| 0006h | System Clock Control Register 0 | CM0 | 00101000b |
| 0007h | System Clock Control Register 1 | CM1 | 00100000b |
| 0008h | Module Standby Control Register | MSTCR | 00h |
| 0009h | System Clock Control Register 3 | CM3 | 00h |
| 000Ah | Protect Register | PRCR | 00h |
| 000Bh | Reset Source Determination Register | RSTFR | 0XXXXXXb (2) |
| 000Ch | Oscillation Stop Detection Register | OCD | 00000100b |
| 000Dh | Watchdog Timer Reset Register | WDTR | XXh |
| 000Eh | Watchdog Timer Start Register | WDTS | XXh |
| 000Fh | Watchdog Timer Control Register | WDTC | 00111111b |
| 0010h | | | |
| 0011h | | | |
| 0012h | | | |
| 0013h | | | |
| 0014h | | | |
| 0015h | High-Speed On-Chip Oscillator Control Register 7 | FRA7 | When shipping |
| 0016h | | | |
| 0017h | | | |
| 0018h | | | |
| 0019h | | | |
| 001Ah | | | |
| 001Bh | | | |
| 001Ch | Count Source Protection Mode Register | CSPR | 00h 10000000b (3) |
| 001Dh | | | |
| 001Eh | | | |
| 001Fh | | | |
| 0020h | | | |
| 0021h | | | |
| 0022h | | | |
| 0023h | High-Speed On-Chip Oscillator Control Register 0 | FRA0 | 00h |
| 0024h | High-Speed On-Chip Oscillator Control Register 1 | FRA1 | When shipping |
| 0025h | High-Speed On-Chip Oscillator Control Register 2 | FRA2 | 00h |
| 0026h | On-Chip Reference Voltage Control Register | OCVREFCR | 00h |
| 0027h | | | |
| 0028h | Clock Prescaler Reset Flag | CPSRF | 00h |
| 0029h | High-Speed On-Chip Oscillator Control Register 4 | FRA4 | When shipping |
| 002Ah | High-Speed On-Chip Oscillator Control Register 5 | FRA5 | When shipping |
| 002Bh | High-Speed On-Chip Oscillator Control Register 6 | FRA6 | When shipping |
| 002Ch | | | |
| 002Dh | | | |
| 002Eh | | | |
| 002Fh | High-Speed On-Chip Oscillator Control Register 3 | FRA3 | When shipping |
| 0030h | Voltage Monitor Circuit Control Register | CMPA | 00h |
| 0031h | Voltage Monitor Circuit Edge Select Register | VCAC | 00h |
| 0032h | | | |
| 0033h | Voltage Detect Register 1 | VCA1 | 00001000b |
| 0034h | Voltage Detect Register 2 | VCA2 | 00h (4) 00100000b (5) |
| 0035h | | | |
| 0036h | Voltage Detection 1 Level Select Register | VD1LS | 00000111b |
| 0037h | | | |
| 0038h | Voltage Monitor 0 Circuit Control Register | VW0C | 1100X010b (4) 1100X011b (5) |
| 0039h | Voltage Monitor 1 Circuit Control Register | VW1C | 10001010b |

X: Undefined

Notes:

1. The blank areas are reserved and cannot be accessed by users.
2. The CWR bit in the RSTFR register is set to 0 after power-on and voltage monitor 0 reset. Hardware reset, software reset, or watchdog timer reset does not affect this bit.
3. The CSPROINI bit in the OFS register is set to 0.
4. The LVDAS bit in the OFS register is set to 1.
5. The LVDAS bit in the OFS register is set to 0.

Table 4.2 SFR Information (2) (1)

| Address | Register | Symbol | After Reset |
|---------|---|-------------|-------------|
| 003Ah | Voltage Monitor 2 Circuit Control Register | VW2C | 10000010b |
| 003Bh | | | |
| 003Ch | | | |
| 003Dh | | | |
| 003Eh | | | |
| 003Fh | | | |
| 0040h | | | |
| 0041h | Flash Memory Ready Interrupt Control Register | FMRDYIC | XXXXX000b |
| 0042h | | | |
| 0043h | | | |
| 0044h | | | |
| 0045h | | | |
| 0046h | INT4 Interrupt Control Register | INT4IC | XX00X000b |
| 0047h | Timer RC Interrupt Control Register | TRCIC | XXXXX000b |
| 0048h | Timer RD0 Interrupt Control Register | TRD0IC | XXXXX000b |
| 0049h | Timer RD1 Interrupt Control Register | TRD1IC | XXXXX000b |
| 004Ah | Timer RE Interrupt Control Register | TREIC | XXXXX000b |
| 004Bh | UART2 Transmit Interrupt Control Register | S2TIC | XXXXX000b |
| 004Ch | UART2 Receive Interrupt Control Register | S2RIC | XXXXX000b |
| 004Dh | Key Input Interrupt Control Register | KUPIC | XXXXX000b |
| 004Eh | A/D Conversion Interrupt Control Register | ADIC | XXXXX000b |
| 004Fh | SSU Interrupt Control Register/IIC bus Interrupt Control Register (2) | SSUIC/IICIC | XXXXX000b |
| 0050h | Timer RF Compare 1 Interrupt Control Register | CMP1IC | XXXXX000b |
| 0051h | UART0 Transmit Interrupt Control Register | S0TIC | XXXXX000b |
| 0052h | UART0 Receive Interrupt Control Register | S0RIC | XXXXX000b |
| 0053h | UART1 Transmit Interrupt Control Register | S1TIC | XXXXX000b |
| 0054h | UART1 Receive Interrupt Control Register | S1RIC | XXXXX000b |
| 0055h | INT2 Interrupt Control Register | INT2IC | XX00X000b |
| 0056h | Timer RA Interrupt Control Register | TRAIC | XXXXX000b |
| 0057h | | | |
| 0058h | Timer RB Interrupt Control Register | TRBIC | XXXXX000b |
| 0059h | INT1 Interrupt Control Register | INT1IC | XX00X000b |
| 005Ah | INT3 Interrupt Control Register | INT3IC | XX00X000b |
| 005Bh | Timer RF Interrupt Control Register | TRFIC | XXXXX000b |
| 005Ch | Timer RF Compare 0 Interrupt Control Register | CMP0IC | XXXXX000b |
| 005Dh | INT0 Interrupt Control Register | INT0IC | XX00X000b |
| 005Eh | UART2 Bus Collision Detection Interrupt Control Register | U2BCNIC | XXXXX000b |
| 005Fh | Timer RF Capture Interrupt Control Register | CAPIC | XXXXX000b |
| 0060h | | | |
| 0061h | | | |
| 0062h | | | |
| 0063h | | | |
| 0064h | | | |
| 0065h | | | |
| 0066h | | | |
| 0067h | | | |
| 0068h | | | |
| 0069h | | | |
| 006Ah | | | |
| 006Bh | Timer RG Interrupt Control Register | TRGIC | XXXXX000b |
| 006Ch | | | |
| 006Dh | | | |
| 006Eh | | | |
| 006Fh | | | |
| 0070h | | | |
| 0071h | | | |
| 0072h | Voltage Monitor 1 Interrupt Control Register | VCMP1IC | XXXXX000b |
| 0073h | Voltage Monitor 2 Interrupt Control Register | VCMP2IC | XXXXX000b |
| 0074h | | | |
| 0075h | | | |
| 0076h | | | |
| 0077h | | | |
| 0078h | | | |
| 0079h | | | |
| 007Ah | | | |
| 007Bh | | | |
| 007Ch | | | |
| 007Dh | | | |
| 007Eh | | | |
| 007Fh | | | |

X: Undefined

Notes:

1. The blank areas are reserved and cannot be accessed by users.
2. Selectable by the IICSEL bit in the SSUICSR register.

Table 4.3 SFR Information (3) (1)

| Address | Register | Symbol | After Reset |
|---------|---|--------|-------------|
| 0080h | DTC Activation Control Register | DTCTL | 00h |
| 0081h | | | |
| 0082h | | | |
| 0083h | | | |
| 0084h | | | |
| 0085h | | | |
| 0086h | | | |
| 0087h | | | |
| 0088h | DTC Activation Enable Register 0 | DTCEN0 | 00h |
| 0089h | DTC Activation Enable Register 1 | DTCEN1 | 00h |
| 008Ah | DTC Activation Enable Register 2 | DTCEN2 | 00h |
| 008Bh | DTC Activation Enable Register 3 | DTCEN3 | 00h |
| 008Ch | DTC Activation Enable Register 4 | DTCEN4 | 00h |
| 008Dh | DTC Activation Enable Register 5 | DTCEN5 | 00h |
| 008Eh | DTC Activation Enable Register 6 | DTCEN6 | 00h |
| 008Fh | | | |
| 0090h | Timer RF Register | TRF | 00h |
| 0091h | | | 00h |
| 0092h | | | |
| 0093h | | | |
| 0094h | | | |
| 0095h | | | |
| 0096h | | | |
| 0097h | | | |
| 0098h | | | |
| 0099h | | | |
| 009Ah | Timer RF Control Register 0 | TRFCR0 | 00h |
| 009Bh | Timer RF Control Register 1 | TRFCR1 | 00h |
| 009Ch | Capture and Compare 0 Register | TRFM0 | 00h |
| 009Dh | | | 00h |
| 009Eh | Compare 1 Register | TRFM1 | FFh |
| 009Fh | | | FFh |
| 00A0h | UART0 Transmit/Receive Mode Register | U0MR | 00h |
| 00A1h | UART0 Bit Rate Register | U0BRG | XXh |
| 00A2h | UART0 Transmit Buffer Register | U0TB | XXh |
| 00A3h | | | XXh |
| 00A4h | UART0 Transmit/Receive Control Register 0 | U0C0 | 00001000b |
| 00A5h | UART0 Transmit/Receive Control Register 1 | U0C1 | 00000010b |
| 00A6h | UART0 Receive Buffer Register | U0RB | XXh |
| 00A7h | | | XXh |
| 00A8h | UART2 Transmit/Receive Mode Register | U2MR | 00h |
| 00A9h | UART2 Bit Rate Register | U2BRG | XXh |
| 00AAh | UART2 Transmit Buffer Register | U2TB | XXh |
| 00ABh | | | XXh |
| 00ACh | UART2 Transmit/Receive Control Register 0 | U2C0 | 00001000b |
| 00ADh | UART2 Transmit/Receive Control Register 1 | U2C1 | 00000010b |
| 00AEh | UART2 Receive Buffer Register | U2RB | XXh |
| 00AFh | | | XXh |
| 00B0h | UART2 Digital Filter Function Select Register | URXDF | 00h |
| 00B1h | | | |
| 00B2h | | | |
| 00B3h | | | |
| 00B4h | | | |
| 00B5h | | | |
| 00B6h | | | |
| 00B7h | | | |
| 00B8h | | | |
| 00B9h | | | |
| 00BAh | | | |
| 00BBh | UART2 Special Mode Register 5 | U2SMR5 | 00h |
| 00BCh | UART2 Special Mode Register 4 | U2SMR4 | 00h |
| 00BDh | UART2 Special Mode Register 3 | U2SMR3 | 00X0X0Xb |
| 00BEh | UART2 Special Mode Register 2 | U2SMR2 | X0000000b |
| 00BFh | UART2 Special Mode Register | U2SMR | X0000000b |

X: Undefined

Note:

1. The blank areas are reserved and cannot be accessed by users.

Table 4.4 SFR Information (4) (1)

| Address | Register | Symbol | After Reset |
|---------|----------------------------|---------|-------------|
| 00C0h | A/D Register 0 | AD0 | XXh |
| 00C1h | | | 000000XXb |
| 00C2h | A/D Register 1 | AD1 | XXh |
| 00C3h | | | 000000XXb |
| 00C4h | A/D Register 2 | AD2 | XXh |
| 00C5h | | | 000000XXb |
| 00C6h | A/D Register 3 | AD3 | XXh |
| 00C7h | | | 000000XXb |
| 00C8h | A/D Register 4 | AD4 | XXh |
| 00C9h | | | 000000XXb |
| 00CAh | A/D Register 5 | AD5 | XXh |
| 00CBh | | | 000000XXb |
| 00CCh | A/D Register 6 | AD6 | XXh |
| 00CDh | | | 000000XXb |
| 00CEh | A/D Register 7 | AD7 | XXh |
| 00CFh | | | 000000XXb |
| 00D0h | | | |
| 00D1h | | | |
| 00D2h | | | |
| 00D3h | | | |
| 00D4h | A/D Mode Register | ADMOD | 00h |
| 00D5h | A/D Input Select Register | ADINSEL | 11000000b |
| 00D6h | A/D Control Register 0 | ADCON0 | 00h |
| 00D7h | A/D Control Register 1 | ADCON1 | 00h |
| 00D8h | D/A0 Register | DA0 | 00h |
| 00D9h | D/A1 Register | DA1 | 00h |
| 00DAh | | | |
| 00DBh | | | |
| 00DCh | D/A Control Register | DACON | 00h |
| 00DDh | | | |
| 00DEh | | | |
| 00DFh | | | |
| 00E0h | Port P0 Register | P0 | XXh |
| 00E1h | Port P1 Register | P1 | XXh |
| 00E2h | Port P0 Direction Register | PD0 | 00h |
| 00E3h | Port P1 Direction Register | PD1 | 00h |
| 00E4h | Port P2 Register | P2 | XXh |
| 00E5h | Port P3 Register | P3 | XXh |
| 00E6h | Port P2 Direction Register | PD2 | 00h |
| 00E7h | Port P3 Direction Register | PD3 | 00h |
| 00E8h | Port P4 Register | P4 | XXh |
| 00E9h | Port P5 Register | P5 | XXh |
| 00EAh | Port P4 Direction Register | PD4 | 00h |
| 00EBh | Port P5 Direction Register | PD5 | 00h |
| 00ECh | Port P6 Register | P6 | XXh |
| 00EDh | | | |
| 00EEh | Port P6 Direction Register | PD6 | 00h |
| 00EFh | | | |
| 00F0h | Port P8 Register | P8 | XXh |
| 00F1h | | | |
| 00F2h | Port P8 Direction Register | PD8 | 00h |
| 00F3h | | | |
| 00F4h | | | |
| 00F5h | | | |
| 00F6h | | | |
| 00F7h | | | |
| 00F8h | | | |
| 00F9h | | | |
| 00FAh | | | |
| 00FBh | | | |
| 00FCh | | | |
| 00FDh | | | |
| 00FEh | | | |
| 00FFh | | | |

X: Undefined

Note:

1. The blank areas are reserved and cannot be accessed by users.

Table 4.5 SFR Information (5) (1)

| Address | Register | Symbol | After Reset |
|---------|---|---------|-------------|
| 0100h | Timer RA Control Register | TRACR | 00h |
| 0101h | Timer RA I/O Control Register | TRAIOC | 00h |
| 0102h | Timer RA Mode Register | TRAMR | 00h |
| 0103h | Timer RA Prescaler Register | TRAPRE | FFh |
| 0104h | Timer RA Register | TRA | FFh |
| 0105h | LIN Control Register 2 | LINCR2 | 00h |
| 0106h | LIN Control Register | LINCR | 00h |
| 0107h | LIN Status Register | LINST | 00h |
| 0108h | Timer RB Control Register | TRBCR | 00h |
| 0109h | Timer RB One-Shot Control Register | TRBOCR | 00h |
| 010Ah | Timer RB I/O Control Register | TRBIOC | 00h |
| 010Bh | Timer RB Mode Register | TRBMR | 00h |
| 010Ch | Timer RB Prescaler Register | TRBPRE | FFh |
| 010Dh | Timer RB Secondary Register | TRBSC | FFh |
| 010Eh | Timer RB Primary Register | TRBPR | FFh |
| 010Fh | | | |
| 0110h | | | |
| 0111h | | | |
| 0112h | | | |
| 0113h | | | |
| 0114h | | | |
| 0115h | | | |
| 0116h | | | |
| 0117h | | | |
| 0118h | Timer RE Second Data Register / Counter Data Register | TRESEC | 00h |
| 0119h | Timer RE Minute Data Register / Compare Data Register | TREMIN | 00h |
| 011Ah | Timer RE Hour Data Register | TREHR | 00h |
| 011Bh | Timer RE Day of Week Data Register | TREWK | 00h |
| 011Ch | Timer RE Control Register 1 | TRECR1 | 00h |
| 011Dh | Timer RE Control Register 2 | TRECR2 | 00h |
| 011Eh | Timer RE Count Source Select Register | TRECSR | 00001000b |
| 011Fh | | | |
| 0120h | Timer RC Mode Register | TRCMR | 01001000b |
| 0121h | Timer RC Control Register 1 | TRCCR1 | 00h |
| 0122h | Timer RC Interrupt Enable Register | TRCIER | 01110000b |
| 0123h | Timer RC Status Register | TRCSR | 01110000b |
| 0124h | Timer RC I/O Control Register 0 | TRCIOR0 | 10001000b |
| 0125h | Timer RC I/O Control Register 1 | TRCIOR1 | 10001000b |
| 0126h | Timer RC Counter | TRC | 00h |
| 0127h | | | 00h |
| 0128h | Timer RC General Register A | TRCGRA | FFh |
| 0129h | | | FFh |
| 012Ah | Timer RC General Register B | TRCGRB | FFh |
| 012Bh | | | FFh |
| 012Ch | Timer RC General Register C | TRCGRC | FFh |
| 012Dh | | | FFh |
| 012Eh | Timer RC General Register D | TRCGRD | FFh |
| 012Fh | | | FFh |
| 0130h | Timer RC Control Register 2 | TRCCR2 | 00011000b |
| 0131h | Timer RC Digital Filter Function Select Register | TRCDF | 00h |
| 0132h | Timer RC Output Master Enable Register | TRCOER | 01111111b |
| 0133h | Timer RC Trigger Control Register | TRCADCR | 00h |
| 0134h | | | |
| 0135h | Timer RD Control Expansion Register | TRDECR | 00h |
| 0136h | Timer RD Trigger Control Register | TRDADCR | 00h |
| 0137h | Timer RD Start Register | TRDSTR | 11111100b |
| 0138h | Timer RD Mode Register | TRDMR | 00001110b |
| 0139h | Timer RD PWM Mode Register | TRDPMR | 10001000b |
| 013Ah | Timer RD Function Control Register | TRDFCR | 10000000b |
| 013Bh | Timer RD Output Master Enable Register 1 | TRDOER1 | FFh |
| 013Ch | Timer RD Output Master Enable Register 2 | TRDOER2 | 01111111b |
| 013Dh | Timer RD Output Control Register | TRDOCR | 00h |
| 013Eh | Timer RD Digital Filter Function Select Register 0 | TRDDF0 | 00h |
| 013Fh | Timer RD Digital Filter Function Select Register 1 | TRDDF1 | 00h |

Note:

1. The blank areas are reserved and cannot be accessed by users.

Table 4.6 SFR Information (6) (1)

| Address | Register | Symbol | After Reset |
|---------|---|----------|-------------|
| 0140h | Timer RD Control Register 0 | TRDCR0 | 00h |
| 0141h | Timer RD I/O Control Register A0 | TRDIORA0 | 10001000b |
| 0142h | Timer RD I/O Control Register C0 | TRDIORC0 | 10001000b |
| 0143h | Timer RD Status Register 0 | TRDSR0 | 11100000b |
| 0144h | Timer RD Interrupt Enable Register 0 | TRDIER0 | 11100000b |
| 0145h | Timer RD PWM Mode Output Level Control Register 0 | TRDPOCR0 | 11111000b |
| 0146h | Timer RD Counter 0 | TRD0 | 00h |
| 0147h | | | 00h |
| 0148h | Timer RD General Register A0 | TRDGRA0 | FFh |
| 0149h | | | FFh |
| 014Ah | Timer RD General Register B0 | TRDGRB0 | FFh |
| 014Bh | | | FFh |
| 014Ch | Timer RD General Register C0 | TRDGRC0 | FFh |
| 014Dh | | | FFh |
| 014Eh | Timer RD General Register D0 | TRDGRD0 | FFh |
| 014Fh | | | FFh |
| 0150h | Timer RD Control Register 1 | TRDCR1 | 00h |
| 0151h | Timer RD I/O Control Register A1 | TRDIORA1 | 10001000b |
| 0152h | Timer RD I/O Control Register C1 | TRDIORC1 | 10001000b |
| 0153h | Timer RD Status Register 1 | TRDSR1 | 11000000b |
| 0154h | Timer RD Interrupt Enable Register 1 | TRDIER1 | 11100000b |
| 0155h | Timer RD PWM Mode Output Level Control Register 1 | TRDPOCR1 | 11111000b |
| 0156h | Timer RD Counter 1 | TRD1 | 00h |
| 0157h | | | 00h |
| 0158h | Timer RD General Register A1 | TRDGRA1 | FFh |
| 0159h | | | FFh |
| 015Ah | Timer RD General Register B1 | TRDGRB1 | FFh |
| 015Bh | | | FFh |
| 015Ch | Timer RD General Register C1 | TRDGRC1 | FFh |
| 015Dh | | | FFh |
| 015Eh | Timer RD General Register D1 | TRDGRD1 | FFh |
| 015Fh | | | FFh |
| 0160h | UART1 Transmit/Receive Mode Register | U1MR | 00h |
| 0161h | UART1 Bit Rate Register | U1BRG | XXh |
| 0162h | UART1 Transmit Buffer Register | U1TB | XXh |
| 0163h | | | XXh |
| 0164h | UART1 Transmit/Receive Control Register 0 | U1C0 | 00001000b |
| 0165h | UART1 Transmit/Receive Control Register 1 | U1C1 | 00000010b |
| 0166h | UART1 Receive Buffer Register | U1RB | XXh |
| 0167h | | | XXh |
| 0168h | | | |
| 0169h | | | |
| 016Ah | | | |
| 016Bh | | | |
| 016Ch | | | |
| 016Dh | | | |
| 016Eh | | | |
| 016Fh | | | |
| 0170h | Timer RG Mode Register | TRGMR | 01000000b |
| 0171h | Timer RG Count Control Register | TRGCNTC | 00h |
| 0172h | Timer RG Control Register | TRGCR | 10000000b |
| 0173h | Timer RG Interrupt Enable Register | TRGIER | 11110000b |
| 0174h | Timer RG Status Register | TRGSR | 11100000b |
| 0175h | Timer RG I/O Control Register | TRGIOR | 00h |
| 0176h | Timer RG Counter | TRG | 00h |
| 0177h | | | 00h |
| 0178h | Timer RG General Register A | TRGGRA | FFh |
| 0179h | | | FFh |
| 017Ah | Timer RG General Register B | TRGGRB | FFh |
| 017Bh | | | FFh |
| 017Ch | Timer RG General Register C | TRGGRC | FFh |
| 017Dh | | | FFh |
| 017Eh | Timer RG General Register D | TRGGRD | FFh |
| 017Fh | | | FFh |

X: Undefined

Note:

1. The blank areas are reserved and cannot be accessed by users.

Table 4.7 SFR Information (7) (1)

| Address | Register | Symbol | After Reset |
|---------|--|---------------|-----------------------|
| 0180h | Timer RA Pin Select Register | TRASR | 00h |
| 0181h | Timer RB/RC Pin Select Register | TRBRCR | 00h |
| 0182h | Timer RC Pin Select Register 0 | TRCPSR0 | 00h |
| 0183h | Timer RC Pin Select Register 1 | TRCPSR1 | 00h |
| 0184h | Timer RD Pin Select Register 0 | TRDPSR0 | 00h |
| 0185h | Timer RD Pin Select Register 1 | TRDPSR1 | 00h |
| 0186h | Timer Pin Select Register | TIMSR | 00h |
| 0187h | Timer RF Output Control Register | TRFOUT | 00h |
| 0188h | UART0 Pin Select Register | U0SR | 00h |
| 0189h | UART1 Pin Select Register | U1SR | 00h |
| 018Ah | UART2 Pin Select Register 0 | U2SR0 | 00h |
| 018Bh | UART2 Pin Select Register 1 | U2SR1 | 00h |
| 018Ch | SSU/IIC Pin Select Register | SSUICSR | 00h |
| 018Dh | | | |
| 018Eh | INT Interrupt Input Pin Select Register | INTSR | 00h |
| 018Fh | I/O Function Pin Select Register | PINSR | 00h |
| 0190h | | | |
| 0191h | | | |
| 0192h | | | |
| 0193h | SS Bit Counter Register | SSBR | 11111000b |
| 0194h | SS Transmit Data Register L / IIC bus Transmit Data Register (2) | SSTDR / ICDRT | FFh |
| 0195h | SS Transmit Data Register H (2) | SSTDRH | FFh |
| 0196h | SS Receive Data Register L / IIC bus Receive Data Register (2) | SSRDR / ICDRR | FFh |
| 0197h | SS Receive Data Register H (2) | SSRDRH | FFh |
| 0198h | SS Control Register H / IIC bus Control Register 1 (2) | SSCRH / ICCR1 | 00h |
| 0199h | SS Control Register L / IIC bus Control Register 2 (2) | SSCRL / ICCR2 | 01111101b |
| 019Ah | SS Mode Register / IIC bus Mode Register (2) | SSMR / ICMR | 00010000b / 00011000b |
| 019Bh | SS Enable Register / IIC bus Interrupt Enable Register (2) | SSER / ICIER | 00h |
| 019Ch | SS Status Register / IIC bus Status Register (2) | SSSR / ICSR | 00h / 0000X000b |
| 019Dh | SS Mode Register 2 / Slave Address Register (2) | SSMR2 / SAR | 00h |
| 019Eh | | | |
| 019Fh | | | |
| 01A0h | | | |
| 01A1h | | | |
| 01A2h | | | |
| 01A3h | | | |
| 01A4h | | | |
| 01A5h | | | |
| 01A6h | | | |
| 01A7h | | | |
| 01A8h | | | |
| 01A9h | | | |
| 01AAh | | | |
| 01ABh | | | |
| 01ACh | | | |
| 01ADh | | | |
| 01AEh | | | |
| 01AFh | | | |
| 01B0h | | | |
| 01B1h | | | |
| 01B2h | Flash Memory Status Register | FST | 10000X00b |
| 01B3h | | | |
| 01B4h | Flash Memory Control Register 0 | FMR0 | 00h |
| 01B5h | Flash Memory Control Register 1 | FMR1 | 00h |
| 01B6h | Flash Memory Control Register 2 | FMR2 | 00h |
| 01B7h | | | |
| 01B8h | | | |
| 01B9h | | | |
| 01BAh | | | |
| 01BBh | | | |
| 01BCh | | | |
| 01BDh | | | |
| 01BEh | | | |
| 01BFh | | | |

X: Undefined

Notes:

1. The blank areas are reserved and cannot be accessed by users.
2. Selectable by the IICSEL bit in the SSUICSR register.

Table 4.8 SFR Information (8) (1)

| Address | Register | Symbol | After Reset |
|---------|---|--------|-------------|
| 01C0h | Address Match Interrupt Register 0 | RMAD0 | XXh |
| 01C1h | | | XXh |
| 01C2h | | | 0000XXXXb |
| 01C3h | Address Match Interrupt Enable Register 0 | AIER0 | 00h |
| 01C4h | Address Match Interrupt Register 1 | RMAD1 | XXh |
| 01C5h | | | XXh |
| 01C6h | | | 0000XXXXb |
| 01C7h | Address Match Interrupt Enable Register 1 | AIER1 | 00h |
| 01C8h | | | |
| 01C9h | | | |
| 01CAh | | | |
| 01CBh | | | |
| 01CCh | | | |
| 01CDh | | | |
| 01CEh | | | |
| 01CFh | | | |
| 01D0h | | | |
| 01D1h | | | |
| 01D2h | | | |
| 01D3h | | | |
| 01D4h | | | |
| 01D5h | | | |
| 01D6h | | | |
| 01D7h | | | |
| 01D8h | | | |
| 01D9h | | | |
| 01DAh | | | |
| 01DBh | | | |
| 01DCh | | | |
| 01DDh | | | |
| 01DEh | | | |
| 01DFh | | | |
| 01E0h | Pull-Up Control Register 0 | PUR0 | 00h |
| 01E1h | Pull-Up Control Register 1 | PUR1 | 00h |
| 01E2h | Pull-Up Control Register 2 | PUR2 | 00h |
| 01E3h | | | |
| 01E4h | | | |
| 01E5h | | | |
| 01E6h | | | |
| 01E7h | | | |
| 01E8h | | | |
| 01E9h | | | |
| 01EAh | | | |
| 01EBh | | | |
| 01ECh | | | |
| 01EDh | | | |
| 01EEh | | | |
| 01EFh | | | |
| 01F0h | Port P1 Drive Capacity Control Register | P1DRR | 00h |
| 01F1h | Port P2 Drive Capacity Control Register | P2DRR | 00h |
| 01F2h | Drive Capacity Control Register 0 | DRR0 | 00h |
| 01F3h | Drive Capacity Control Register 1 | DRR1 | 00h |
| 01F4h | Drive Capacity Control Register 2 | DRR2 | 00h |
| 01F5h | Input Threshold Control Register 0 | VLT0 | 00h |
| 01F6h | Input Threshold Control Register 1 | VLT1 | 00h |
| 01F7h | Input Threshold Control Register 2 | VLT2 | 00h |
| 01F8h | Comparator B Control Register 0 | INTCMP | 00h |
| 01F9h | | | |
| 01FAh | External Input Enable Register 0 | INTEN | 00h |
| 01FBh | External Input Enable Register 1 | INTEN1 | 00h |
| 01FCh | INT Input Filter Select Register 0 | INTF | 00h |
| 01FDh | INT Input Filter Select Register 1 | INTF1 | 00h |
| 01FEh | Key Input Enable Register 0 | KIEN | 00h |
| 01FFh | | | |

X: Undefined

Note:

1. The blank areas are reserved and cannot be accessed by users.

Table 4.9 SFR Information (9) (1)

| Address | Register | Symbol | After Reset |
|---------|--------------------------|--------|-------------|
| 2C00h | DTC Transfer Vector Area | | XXh |
| 2C01h | DTC Transfer Vector Area | | XXh |
| 2C02h | DTC Transfer Vector Area | | XXh |
| 2C03h | DTC Transfer Vector Area | | XXh |
| 2C04h | DTC Transfer Vector Area | | XXh |
| 2C05h | DTC Transfer Vector Area | | XXh |
| 2C06h | DTC Transfer Vector Area | | XXh |
| 2C07h | DTC Transfer Vector Area | | XXh |
| 2C08h | DTC Transfer Vector Area | | XXh |
| 2C09h | DTC Transfer Vector Area | | XXh |
| 2C0Ah | DTC Transfer Vector Area | | XXh |
| : | DTC Transfer Vector Area | | XXh |
| : | DTC Transfer Vector Area | | XXh |
| 2C3Ah | DTC Transfer Vector Area | | XXh |
| 2C3Bh | DTC Transfer Vector Area | | XXh |
| 2C3Ch | DTC Transfer Vector Area | | XXh |
| 2C3Dh | DTC Transfer Vector Area | | XXh |
| 2C3Eh | DTC Transfer Vector Area | | XXh |
| 2C3Fh | DTC Transfer Vector Area | | XXh |
| 2C40h | DTC Control Data 0 | DTCD0 | XXh |
| 2C41h | | | XXh |
| 2C42h | | | XXh |
| 2C43h | | | XXh |
| 2C44h | | | XXh |
| 2C45h | | | XXh |
| 2C46h | | | XXh |
| 2C47h | | | XXh |
| 2C48h | DTC Control Data 1 | DTCD1 | XXh |
| 2C49h | | | XXh |
| 2C4Ah | | | XXh |
| 2C4Bh | | | XXh |
| 2C4Ch | | | XXh |
| 2C4Dh | | | XXh |
| 2C4Eh | | | XXh |
| 2C4Fh | | | XXh |
| 2C50h | DTC Control Data 2 | DTCD2 | XXh |
| 2C51h | | | XXh |
| 2C52h | | | XXh |
| 2C53h | | | XXh |
| 2C54h | | | XXh |
| 2C55h | | | XXh |
| 2C56h | | | XXh |
| 2C57h | | | XXh |
| 2C58h | DTC Control Data 3 | DTCD3 | XXh |
| 2C59h | | | XXh |
| 2C5Ah | | | XXh |
| 2C5Bh | | | XXh |
| 2C5Ch | | | XXh |
| 2C5Dh | | | XXh |
| 2C5Eh | | | XXh |
| 2C5Fh | | | XXh |
| 2C60h | DTC Control Data 4 | DTCD4 | XXh |
| 2C61h | | | XXh |
| 2C62h | | | XXh |
| 2C63h | | | XXh |
| 2C64h | | | XXh |
| 2C65h | | | XXh |
| 2C66h | | | XXh |
| 2C67h | | | XXh |
| 2C68h | DTC Control Data 5 | DTCD5 | XXh |
| 2C69h | | | XXh |
| 2C6Ah | | | XXh |
| 2C6Bh | | | XXh |
| 2C6Ch | | | XXh |
| 2C6Dh | | | XXh |
| 2C6Eh | | | XXh |
| 2C6Fh | | | XXh |

X: Undefined

Note:

1. The blank areas are reserved and cannot be accessed by users.

Table 4.10 SFR Information (10) (1)

| Address | Register | Symbol | After Reset |
|---------|---------------------|--------|-------------|
| 2C70h | DTC Control Data 6 | DTCD6 | XXh |
| 2C71h | | | XXh |
| 2C72h | | | XXh |
| 2C73h | | | XXh |
| 2C74h | | | XXh |
| 2C75h | | | XXh |
| 2C76h | | | XXh |
| 2C77h | | | XXh |
| 2C78h | DTC Control Data 7 | DTCD7 | XXh |
| 2C79h | | | XXh |
| 2C7Ah | | | XXh |
| 2C7Bh | | | XXh |
| 2C7Ch | | | XXh |
| 2C7Dh | | | XXh |
| 2C7Eh | | | XXh |
| 2C7Fh | | | XXh |
| 2C80h | DTC Control Data 8 | DTCD8 | XXh |
| 2C81h | | | XXh |
| 2C82h | | | XXh |
| 2C83h | | | XXh |
| 2C84h | | | XXh |
| 2C85h | | | XXh |
| 2C86h | | | XXh |
| 2C87h | | | XXh |
| 2C88h | DTC Control Data 9 | DTCD9 | XXh |
| 2C89h | | | XXh |
| 2C8Ah | | | XXh |
| 2C8Bh | | | XXh |
| 2C8Ch | | | XXh |
| 2C8Dh | | | XXh |
| 2C8Eh | | | XXh |
| 2C8Fh | | | XXh |
| 2C90h | DTC Control Data 10 | DTCD10 | XXh |
| 2C91h | | | XXh |
| 2C92h | | | XXh |
| 2C93h | | | XXh |
| 2C94h | | | XXh |
| 2C95h | | | XXh |
| 2C96h | | | XXh |
| 2C97h | | | XXh |
| 2C98h | DTC Control Data 11 | DTCD11 | XXh |
| 2C99h | | | XXh |
| 2C9Ah | | | XXh |
| 2C9Bh | | | XXh |
| 2C9Ch | | | XXh |
| 2C9Dh | | | XXh |
| 2C9Eh | | | XXh |
| 2C9Fh | | | XXh |
| 2CA0h | DTC Control Data 12 | DTCD12 | XXh |
| 2CA1h | | | XXh |
| 2CA2h | | | XXh |
| 2CA3h | | | XXh |
| 2CA4h | | | XXh |
| 2CA5h | | | XXh |
| 2CA6h | | | XXh |
| 2CA7h | | | XXh |
| 2CA8h | DTC Control Data 13 | DTCD13 | XXh |
| 2CA9h | | | XXh |
| 2CAAh | | | XXh |
| 2CABh | | | XXh |
| 2CACH | | | XXh |
| 2CADh | | | XXh |
| 2CAEh | | | XXh |
| 2CAFh | | | XXh |

X: Undefined

Note:

1. The blank areas are reserved and cannot be accessed by users.

Table 4.11 SFR Information (11) (1)

| Address | Register | Symbol | After Reset |
|---------|---------------------|--------|-------------|
| 2CB0h | DTC Control Data 14 | DTCD14 | XXh |
| 2CB1h | | | XXh |
| 2CB2h | | | XXh |
| 2CB3h | | | XXh |
| 2CB4h | | | XXh |
| 2CB5h | | | XXh |
| 2CB6h | | | XXh |
| 2CB7h | | | XXh |
| 2CB8h | DTC Control Data 15 | DTCD15 | XXh |
| 2CB9h | | | XXh |
| 2CBAh | | | XXh |
| 2CBBh | | | XXh |
| 2CBCh | | | XXh |
| 2CBDh | | | XXh |
| 2CBEh | | | XXh |
| 2CBFh | | | XXh |
| 2CC0h | DTC Control Data 16 | DTCD16 | XXh |
| 2CC1h | | | XXh |
| 2CC2h | | | XXh |
| 2CC3h | | | XXh |
| 2CC4h | | | XXh |
| 2CC5h | | | XXh |
| 2CC6h | | | XXh |
| 2CC7h | | | XXh |
| 2CC8h | DTC Control Data 17 | DTCD17 | XXh |
| 2CC9h | | | XXh |
| 2CCAh | | | XXh |
| 2CCBh | | | XXh |
| 2CCCh | | | XXh |
| 2CCDh | | | XXh |
| 2CCEh | | | XXh |
| 2CCFh | | | XXh |
| 2CD0h | DTC Control Data 18 | DTCD18 | XXh |
| 2CD1h | | | XXh |
| 2CD2h | | | XXh |
| 2CD3h | | | XXh |
| 2CD4h | | | XXh |
| 2CD5h | | | XXh |
| 2CD6h | | | XXh |
| 2CD7h | | | XXh |
| 2CD8h | DTC Control Data 19 | DTCD19 | XXh |
| 2CD9h | | | XXh |
| 2CDAh | | | XXh |
| 2CDBh | | | XXh |
| 2CDCh | | | XXh |
| 2CDDh | | | XXh |
| 2CDEh | | | XXh |
| 2CDFh | | | XXh |
| 2CE0h | DTC Control Data 20 | DTCD20 | XXh |
| 2CE1h | | | XXh |
| 2CE2h | | | XXh |
| 2CE3h | | | XXh |
| 2CE4h | | | XXh |
| 2CE5h | | | XXh |
| 2CE6h | | | XXh |
| 2CE7h | | | XXh |
| 2CE8h | DTC Control Data 21 | DTCD21 | XXh |
| 2CE9h | | | XXh |
| 2CEAh | | | XXh |
| 2CEBh | | | XXh |
| 2CECh | | | XXh |
| 2CEDh | | | XXh |
| 2CEEh | | | XXh |
| 2CEFh | | | XXh |

X: Undefined

Note:

1. The blank areas are reserved and cannot be accessed by users.

Table 4.12 SFR Information (12) (1)

| Address | Register | Symbol | After Reset |
|---------|---------------------|--------|-------------|
| 2CF0h | DTC Control Data 22 | DTCD22 | XXh |
| 2CF1h | | | XXh |
| 2CF2h | | | XXh |
| 2CF3h | | | XXh |
| 2CF4h | | | XXh |
| 2CF5h | | | XXh |
| 2CF6h | | | XXh |
| 2CF7h | | | XXh |
| 2CF8h | DTC Control Data 23 | DTCD23 | XXh |
| 2CF9h | | | XXh |
| 2CFAh | | | XXh |
| 2CFBh | | | XXh |
| 2CFCh | | | XXh |
| 2CFDh | | | XXh |
| 2CFEh | | | XXh |
| 2CFFh | | | XXh |
| 2D00h | | | |
| : | | | |
| 2FFFh | | | |

X: Undefined

Note:

- The blank areas are reserved and cannot be accessed by users.

Table 4.13 ID Code Areas and Option Function Select Area

| Address | Area Name | Symbol | After Reset |
|---------|-----------------------------------|--------|-------------|
| : | | | |
| FFDBh | Option Function Select Register 2 | OFS2 | (Note 1) |
| : | | | |
| FFDFh | ID1 | | (Note 2) |
| : | | | |
| FFE3h | ID2 | | (Note 2) |
| : | | | |
| FFEBh | ID3 | | (Note 2) |
| : | | | |
| FFEFh | ID4 | | (Note 2) |
| : | | | |
| FFF3h | ID5 | | (Note 2) |
| : | | | |
| FFF7h | ID6 | | (Note 2) |
| : | | | |
| FFFBh | ID7 | | (Note 2) |
| : | | | |
| FFFFh | Option Function Select Register | OFS | (Note 1) |

Notes:

- The option function select area is allocated in the flash memory, not in the SFRs. Set appropriate values as ROM data by a program.
Do not write additions to the option function select area. If the block including the option function select area is erased, the option function select area is set to FFh.
When blank products are shipped, the option function select area is set to FFh. It is set to the written value after written by the user.
When factory-programming products are shipped, the value of the option function select area is the value programmed by the user.
- The ID code areas are allocated in the flash memory, not in the SFRs. Set appropriate values as ROM data by a program.
Do not write additions to the ID code areas. If the block including the ID code areas is erased, the ID code areas are set to FFh.
When blank products are shipped, the ID code areas are set to FFh. They are set to the written value after written by the user.
When factory-programming products are shipped, the value of the ID code areas is the value programmed by the user.

5. Electrical Characteristics

Table 5.1 Absolute Maximum Ratings

| Symbol | Parameter | Condition | Rated Value | Unit |
|-----------------------------------|-------------------------------|---------------------------------|---|------|
| V _{CC} /AV _{CC} | Supply voltage | | -0.3 to 6.5 | V |
| V _I | Input voltage | | -0.3 to V _{CC} + 0.3 | V |
| V _O | Output voltage | | -0.3 to V _{CC} + 0.3 | V |
| P _d | Power dissipation | -40°C ≤ T _{opr} ≤ 85°C | 500 | mW |
| T _{opr} | Operating ambient temperature | | -20 to 85 (N version)/ -40 to 85 (D version) | °C |
| T _{stg} | Storage temperature | | -65 to 150 | °C |

Table 5.2 Recommended Operating Conditions (1)

| Symbol | Parameter | | Conditions | Standard | | | Unit | | |
|-----------------------------------|---|---------------------------------------|---|---|---------------------------------|----------------------|---------------------|----------------------|---|
| | | | | Min. | Typ. | Max. | | | |
| V _{CC} /AV _{CC} | Supply voltage | | | 1.8 | — | 5.5 | V | | |
| V _{SS} /AV _{SS} | Supply voltage | | | — | 0 | — | V | | |
| V _{IH} | Input "H" voltage | Other than CMOS input | | | 0.8 V _{CC} | — | V _{CC} | V | |
| | | CMOS input | Input level switching function (I/O port) | Input level selection: 0.35 V _{CC} | 4.0 V ≤ V _{CC} ≤ 5.5 V | 0.5 V _{CC} | — | V _{CC} | V |
| | | | | | 2.7 V ≤ V _{CC} < 4.0 V | 0.55 V _{CC} | — | V _{CC} | V |
| | | | | | 1.8 V ≤ V _{CC} < 2.7 V | 0.65 V _{CC} | — | V _{CC} | V |
| | | | | Input level selection: 0.5 V _{CC} | 4.0 V ≤ V _{CC} ≤ 5.5 V | 0.65 V _{CC} | — | V _{CC} | V |
| | | | | | 2.7 V ≤ V _{CC} < 4.0 V | 0.7 V _{CC} | — | V _{CC} | V |
| | | | | | 1.8 V ≤ V _{CC} < 2.7 V | 0.8 V _{CC} | — | V _{CC} | V |
| | | | | Input level selection: 0.7 V _{CC} | 4.0 V ≤ V _{CC} ≤ 5.5 V | 0.85 V _{CC} | — | V _{CC} | V |
| | | | | | 2.7 V ≤ V _{CC} < 4.0 V | 0.85 V _{CC} | — | V _{CC} | V |
| | | | | | 1.8 V ≤ V _{CC} < 2.7 V | 0.85 V _{CC} | — | V _{CC} | V |
| External clock input (XOUT) | | | 1.2 | — | V _{CC} | V | | | |
| V _{IL} | Input "L" voltage | Other than CMOS input | | | 0 | — | 0.2 V _{CC} | V | |
| | | CMOS input | Input level switching function (I/O port) | Input level selection: 0.35 V _{CC} | 4.0 V ≤ V _{CC} ≤ 5.5 V | 0 | — | 0.2 V _{CC} | V |
| | | | | | 2.7 V ≤ V _{CC} < 4.0 V | 0 | — | 0.2 V _{CC} | V |
| | | | | | 1.8 V ≤ V _{CC} < 2.7 V | 0 | — | 0.2 V _{CC} | V |
| | | | | Input level selection: 0.5 V _{CC} | 4.0 V ≤ V _{CC} ≤ 5.5 V | 0 | — | 0.4 V _{CC} | V |
| | | | | | 2.7 V ≤ V _{CC} < 4.0 V | 0 | — | 0.3 V _{CC} | V |
| | | | | | 1.8 V ≤ V _{CC} < 2.7 V | 0 | — | 0.2 V _{CC} | V |
| | | | | Input level selection: 0.7 V _{CC} | 4.0 V ≤ V _{CC} ≤ 5.5 V | 0 | — | 0.55 V _{CC} | V |
| | | | | | 2.7 V ≤ V _{CC} < 4.0 V | 0 | — | 0.45 V _{CC} | V |
| | | | | | 1.8 V ≤ V _{CC} < 2.7 V | 0 | — | 0.35 V _{CC} | V |
| External clock input (XOUT) | | | 0 | — | 0.4 | V | | | |
| I _{OH(sum)} | Peak sum output "H" current | Sum of all pins I _{OH(peak)} | | — | — | -160 | mA | | |
| I _{OH(sum)} | Average sum output "H" current | Sum of all pins I _{OH(avg)} | | — | — | -80 | mA | | |
| I _{OH(peak)} | Peak output "H" current | Drive capacity Low | | — | — | -10 | mA | | |
| | | Drive capacity High | | — | — | -40 | mA | | |
| I _{OH(avg)} | Average output "H" current | Drive capacity Low | | — | — | -5 | mA | | |
| | | Drive capacity High | | — | — | -20 | mA | | |
| I _{OL(sum)} | Peak sum output "L" current | Sum of all pins I _{OL(peak)} | | — | — | 160 | mA | | |
| I _{OL(sum)} | Average sum output "L" current | Sum of all pins I _{OL(avg)} | | — | — | 80 | mA | | |
| I _{OL(peak)} | Peak output "L" current | Drive capacity Low | | — | — | 10 | mA | | |
| | | Drive capacity High | | — | — | 40 | mA | | |
| I _{OL(avg)} | Average output "L" current | Drive capacity Low | | — | — | 5 | mA | | |
| | | Drive capacity High | | — | — | 20 | mA | | |
| f _(XIN) | XIN clock input oscillation frequency | 2.7 V ≤ V _{CC} ≤ 5.5 V | | — | — | 20 | MHz | | |
| | | 1.8 V ≤ V _{CC} < 2.7 V | | — | — | 5 | MHz | | |
| f _(XCIN) | XCIN clock input oscillation frequency | 1.8 V ≤ V _{CC} ≤ 5.5 V | | — | 32.768 | 50 | kHz | | |
| f _{OCO40M} | When used as the count source for timer RC, timer RD or timer RG ⁽³⁾ | 2.7 V ≤ V _{CC} ≤ 5.5 V | | 32 | — | 40 | MHz | | |
| f _{OCO-F} | f _{OCO-F} frequency | 2.7 V ≤ V _{CC} ≤ 5.5 V | | — | — | 20 | MHz | | |
| | | 1.8 V ≤ V _{CC} < 2.7 V | | — | — | 5 | MHz | | |
| — | System clock frequency | 2.7 V ≤ V _{CC} ≤ 5.5 V | | — | — | 20 | MHz | | |
| | | 1.8 V ≤ V _{CC} < 2.7 V | | — | — | 5 | MHz | | |
| f _(BCLK) | CPU clock frequency | 2.7 V ≤ V _{CC} ≤ 5.5 V | | — | — | 20 | MHz | | |
| | | 1.8 V ≤ V _{CC} < 2.7 V | | — | — | 5 | MHz | | |

Notes:

- V_{CC} = 1.8 to 5.5 V and T_{opr} = -20 to 85 °C (N version)/-40 to 85 °C (D version), unless otherwise specified.
- The average output current indicates the average value of current measured during 100 ms.
- f_{OCO40M} can be used as the count source for timer RC, timer RD or timer RG in the range of V_{CC} = 2.7 to 5.5 V.

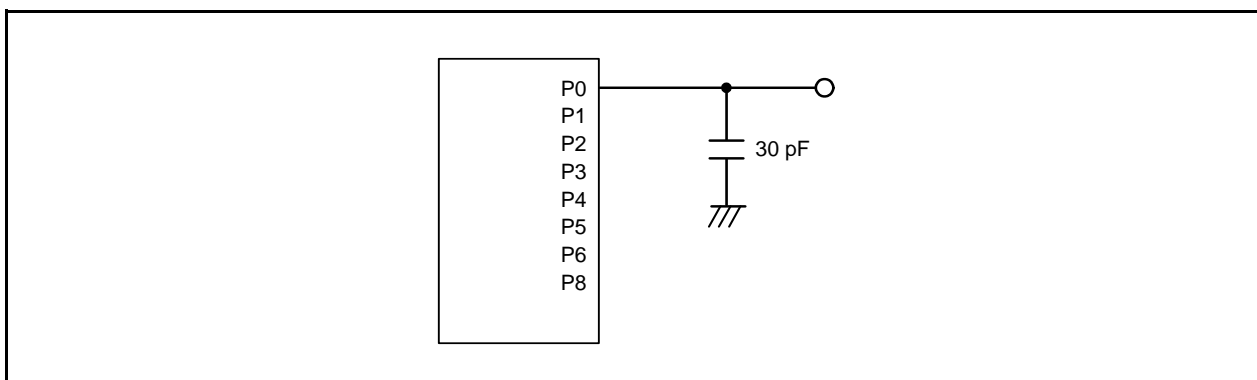

Figure 5.1 Ports P0 to P6, P8 Timing Measurement Circuit

Table 5.3 A/D Converter Characteristics

| Symbol | Parameter | | Conditions | Standard | | | Unit |
|-------------|-------------------------------------|-------------|--|----------|------|-----------|---------------|
| | | | | Min. | Typ. | Max. | |
| — | Resolution | | $V_{ref} = AV_{CC}$ | — | — | 10 | Bit |
| — | Absolute accuracy | 10-bit mode | $V_{ref} = AV_{CC} = 5.0\text{ V}$ AN0 to AN7 input, AN8 to AN11 input | — | — | ± 3 | LSB |
| | | | $V_{ref} = AV_{CC} = 3.3\text{ V}$ AN0 to AN7 input, AN8 to AN11 input | — | — | ± 5 | LSB |
| | | | $V_{ref} = AV_{CC} = 3.0\text{ V}$ AN0 to AN7 input, AN8 to AN11 input | — | — | ± 5 | LSB |
| | | | $V_{ref} = AV_{CC} = 2.2\text{ V}$ AN0 to AN7 input, AN8 to AN11 input | — | — | ± 5 | LSB |
| | | 8-bit mode | $V_{ref} = AV_{CC} = 5.0\text{ V}$ AN0 to AN7 input, AN8 to AN11 input | — | — | ± 2 | LSB |
| | | | $V_{ref} = AV_{CC} = 3.3\text{ V}$ AN0 to AN7 input, AN8 to AN11 input | — | — | ± 2 | LSB |
| | | | $V_{ref} = AV_{CC} = 3.0\text{ V}$ AN0 to AN7 input, AN8 to AN11 input | — | — | ± 2 | LSB |
| | | | $V_{ref} = AV_{CC} = 2.2\text{ V}$ AN0 to AN7 input, AN8 to AN11 input | — | — | ± 2 | LSB |
| ϕ_{AD} | A/D conversion clock | | $4.0\text{ V} \leq V_{ref} = AV_{CC} \leq 5.5\text{ V}^{(2)}$ | 2 | — | 20 | MHz |
| | | | $3.2\text{ V} \leq V_{ref} = AV_{CC} \leq 5.5\text{ V}^{(2)}$ | 2 | — | 16 | MHz |
| | | | $2.7\text{ V} \leq V_{ref} = AV_{CC} \leq 5.5\text{ V}^{(2)}$ | 2 | — | 10 | MHz |
| | | | $2.2\text{ V} \leq V_{ref} = AV_{CC} \leq 5.5\text{ V}^{(2)}$ | 2 | — | 5 | MHz |
| — | Tolerance level impedance | | | — | 3 | — | $k\Omega$ |
| t_{CONV} | Conversion time | 10-bit mode | $V_{ref} = AV_{CC} = 5.0\text{ V}$, $\phi_{AD} = 20\text{ MHz}$ | 2.2 | — | — | μs |
| | | 8-bit mode | $V_{ref} = AV_{CC} = 5.0\text{ V}$, $\phi_{AD} = 20\text{ MHz}$ | 2.2 | — | — | μs |
| t_{SAMP} | Sampling time | | $\phi_{AD} = 20\text{ MHz}$ | 0.8 | — | — | μs |
| I_{Vref} | Vref current | | $V_{CC} = 5.0\text{ V}$, $XIN = f_1 = \phi_{AD} = 20\text{ MHz}$ | — | 45 | — | μA |
| V_{ref} | Reference voltage | | | 2.2 | — | AV_{CC} | V |
| V_{IA} | Analog input voltage ⁽³⁾ | | | 0 | — | V_{ref} | V |
| OCVREF | On-chip reference voltage | | $2\text{ MHz} \leq \phi_{AD} \leq 4\text{ MHz}$ | 1.19 | 1.34 | 1.49 | V |

Notes:

- $V_{CC}/AV_{CC} = V_{ref} = 2.2$ to 5.5 V , $V_{SS} = 0\text{ V}$, and $T_{opr} = -20$ to $85\text{ }^\circ\text{C}$ (N version)/ -40 to $85\text{ }^\circ\text{C}$ (D version), unless otherwise specified.
- The A/D conversion result will be undefined in wait mode, stop mode, when the flash memory stops, and in low-current-consumption mode. Do not perform A/D conversion in these states or transition to these states during A/D conversion.
- When the analog input voltage is over the reference voltage, the A/D conversion result will be 3FFh in 10-bit mode and FFh in 8-bit mode.

Table 5.4 D/A Converter Characteristics

| Symbol | Parameter | Condition | Standard | | | Unit |
|------------|-------------------------------|-----------|----------|------|------|-----------|
| | | | Min. | Typ. | Max. | |
| — | Resolution | | — | — | 8 | Bit |
| — | Absolute accuracy | | — | — | 2.5 | LSB |
| t_{su} | Setup time | | — | — | 3 | μs |
| R_o | Output resistor | | — | 6 | — | $k\Omega$ |
| I_{Vref} | Reference power input current | (Note 2) | — | — | 1.5 | mA |

Notes:

- $V_{CC}/AV_{CC} = V_{ref} = 2.7$ to 5.5 V and $T_{opr} = -20$ to 85 °C (N version)/ -40 to 85 °C (D version), unless otherwise specified.
- This applies when one D/A converter is used and the value of the DA_i register ($i = 0$ or 1) for the unused D/A converter is $00h$. The resistor ladder of the A/D converter is not included.

Table 5.5 Comparator B Electrical Characteristics

| Symbol | Parameter | Condition | Standard | | | Unit |
|-----------|---|----------------------------|----------|------|----------------|---------|
| | | | Min. | Typ. | Max. | |
| V_{ref} | IVREF1, IVREF3 input reference voltage | | 0 | — | $V_{CC} - 1.4$ | V |
| V_i | IVCMP1, IVCMP3 input voltage | | -0.3 | — | $V_{CC} + 0.3$ | V |
| — | Offset | | — | 5 | 100 | mV |
| t_d | Comparator output delay time ⁽²⁾ | $V_i = V_{ref} \pm 100$ mV | — | 0.1 | — | μs |
| I_{CMP} | Comparator operating current | $V_{CC} = 5.0$ V | — | 17.5 | — | μA |

Notes:

- $V_{CC} = 2.7$ to 5.5 V and $T_{opr} = -20$ to 85 °C (N version)/ -40 to 85 °C (D version), unless otherwise specified.
- When the digital filter is disabled.

Table 5.6 Flash Memory (Program ROM) Electrical Characteristics

| Symbol | Parameter | Conditions | Standard | | | Unit |
|-------------------------------|---|-----------------------------|----------------------|------|-----------------------------|-------|
| | | | Min. | Typ. | Max. | |
| — | Program/erase endurance ⁽²⁾ | | 1,000 ⁽³⁾ | — | — | times |
| — | Byte program time | | — | 80 | 500 | μs |
| — | Block erase time | | — | 0.3 | — | s |
| t _d (SR-SUS) | Time delay from suspend request until suspend | | — | — | 5 + CPU clock × 3 cycles | ms |
| — | Interval from erase start/restart until following suspend request | | 0 | — | — | μs |
| — | Time from suspend until erase restart | | — | — | 30 + CPU clock × 1 cycle | μs |
| t _d (CMDRST-READY) | Time from when command is forcibly stopped until reading is enabled | | — | — | 30 + CPU clock × 1 cycle | μs |
| — | Program, erase voltage | | 2.7 | — | 5.5 | V |
| — | Read voltage | | 1.8 | — | 5.5 | V |
| — | Program, erase temperature | | 0 | — | 60 | °C |
| — | Data hold time ⁽⁷⁾ | Ambient temperature = 55 °C | 20 | — | — | year |

Notes:

1. V_{CC} = 2.7 to 5.5 V and T_{opr} = 0 to 60 °C, unless otherwise specified.
2. Definition of programming/erasure endurance
The programming and erasure endurance is defined on a per-block basis.
If the programming and erasure endurance is n (n = 1,000), each block can be erased n times. For example, if 1,024 1-byte writes are performed to different addresses in block A, a 1 Kbyte block, and then the block is erased, the programming/erasure endurance still stands at one. However, the same address must not be programmed more than once per erase operation (overwriting prohibited).
3. Endurance to guarantee all electrical characteristics after program and erase. (1 to Min. value can be guaranteed.)
4. In a system that executes multiple programming operations, the actual erasure count can be reduced by writing to sequential addresses in turn so that as much of the block as possible is used up before performing an erase operation. For example, when programming groups of 16 bytes, the effective number of rewrites can be minimized by programming up to 128 groups before erasing them all in one operation. It is also advisable to retain data on the erasure endurance of each block and limit the number of erase operations to a certain number.
5. If an error occurs during block erase, attempt to execute the clear status register command, then execute the block erase command at least three times until the erase error does not occur.
6. Customers desiring program/erase failure rate information should contact their Renesas technical support representative.
7. The data hold time includes time that the power supply is off or the clock is not supplied.

Table 5.7 Flash Memory (Data flash Block A to Block D) Electrical Characteristics

| Symbol | Parameter | Conditions | Standard | | | Unit |
|-------------------------------|---|-----------------------------|-----------------------|------|-----------------------------|-------|
| | | | Min. | Typ. | Max. | |
| — | Program/erase endurance ⁽²⁾ | | 10,000 ⁽³⁾ | — | — | times |
| — | Byte program time (program/erase endurance ≤ 1,000 times) | | — | 160 | 1500 | μs |
| — | Byte program time (program/erase endurance > 1,000 times) | | — | 300 | 1500 | μs |
| — | Block erase time (program/erase endurance ≤ 1,000 times) | | — | 0.2 | 1 | s |
| — | Block erase time (program/erase endurance > 1,000 times) | | — | 0.3 | 1 | s |
| t _d (SR-SUS) | Time delay from suspend request until suspend | | — | — | 5 + CPU clock × 3 cycles | ms |
| — | Interval from erase start/restart until following suspend request | | 0 | — | — | μs |
| — | Time from suspend until erase restart | | — | — | 30 + CPU clock × 1 cycle | μs |
| t _d (CMDRST-READY) | Time from when command is forcibly stopped until reading is enabled | | — | — | 30 + CPU clock × 1 cycle | μs |
| — | Program, erase voltage | | 2.7 | — | 5.5 | V |
| — | Read voltage | | 1.8 | — | 5.5 | V |
| — | Program, erase temperature | | -20 ⁽⁷⁾ | — | 85 | °C |
| — | Data hold time ⁽⁸⁾ | Ambient temperature = 55 °C | 20 | — | — | year |

Notes:

- V_{CC} = 2.7 to 5.5 V and T_{opr} = -20 to 85 °C (N version)/-40 to 85 °C (D version), unless otherwise specified.
- Definition of programming/erasure endurance
The programming and erasure endurance is defined on a per-block basis.
If the programming and erasure endurance is n (n = 10,000), each block can be erased n times. For example, if 1,024 1-byte writes are performed to different addresses in block A, a 1 Kbyte block, and then the block is erased, the programming/erasure endurance still stands at one. However, the same address must not be programmed more than once per erase operation (overwriting prohibited).
- Endurance to guarantee all electrical characteristics after program and erase. (1 to Min. value can be guaranteed.)
- In a system that executes multiple programming operations, the actual erasure count can be reduced by writing to sequential addresses in turn so that as much of the block as possible is used up before performing an erase operation. For example, when programming groups of 16 bytes, the effective number of rewrites can be minimized by programming up to 128 groups before erasing them all in one operation. In addition, averaging the erasure endurance between blocks A to D can further reduce the actual erasure endurance. It is also advisable to retain data on the erasure endurance of each block and limit the number of erase operations to a certain number.
- If an error occurs during block erase, attempt to execute the clear status register command, then execute the block erase command at least three times until the erase error does not occur.
- Customers desiring program/erase failure rate information should contact their Renesas technical support representative.
- 40 °C for D version.
- The data hold time includes time that the power supply is off or the clock is not supplied.

**Figure 5.2 Time delay until Suspend**

Table 5.8 Voltage Detection 0 Circuit Electrical Characteristics

| Symbol | Parameter | Condition | Standard | | | Unit |
|---------|--|---|----------|------|------|------|
| | | | Min. | Typ. | Max. | |
| Vdet0 | Voltage detection level Vdet0_0 ⁽²⁾ | | 1.80 | 1.90 | 2.05 | V |
| | Voltage detection level Vdet0_1 ⁽²⁾ | | 2.15 | 2.35 | 2.50 | V |
| | Voltage detection level Vdet0_2 ⁽²⁾ | | 2.70 | 2.85 | 3.05 | V |
| | Voltage detection level Vdet0_3 ⁽²⁾ | | 3.55 | 3.80 | 4.05 | V |
| — | Voltage detection 0 circuit response time ⁽⁴⁾ | At the falling of Vcc from 5.0 V to (Vdet0_0 – 0.1) V | — | 6 | 150 | μs |
| — | Voltage detection circuit self power consumption | VCA25 = 1, Vcc = 5.0 V | — | 1.5 | — | μA |
| td(E-A) | Waiting time until voltage detection circuit operation starts ⁽³⁾ | | — | — | 100 | μs |

Notes:

1. The measurement condition is Vcc = 1.8 to 5.5 V and Topr = –20 to 85 °C (N version)/–40 to 85 °C (D version).
2. Select the voltage detection level with bits VDSEL0 and VDSEL1 in the OFS register.
3. Necessary time until the voltage detection circuit operates when setting to 1 again after setting the VCA25 bit in the VCA2 register to 0.
4. Time until the voltage monitor 0 reset is generated after the voltage passes Vdet0.

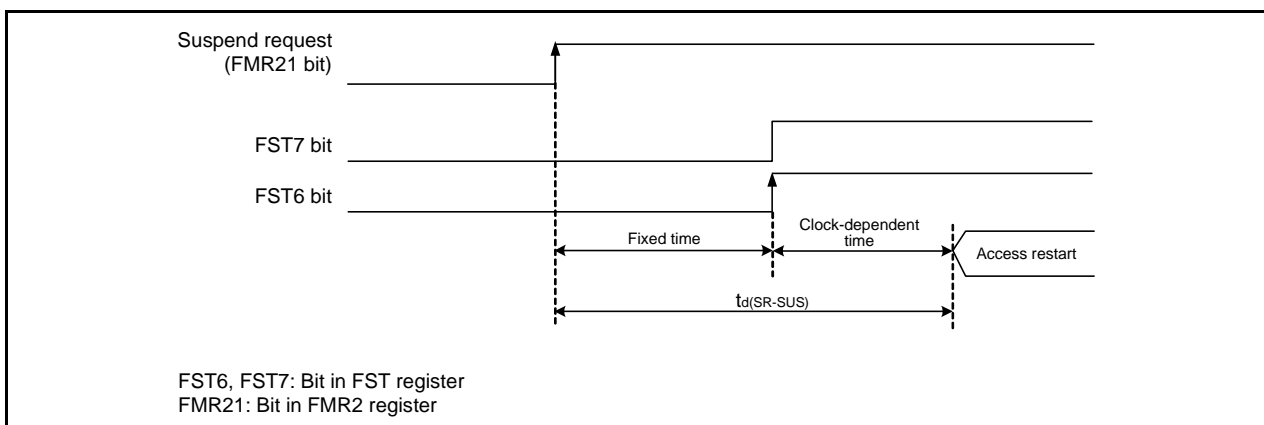
Table 5.9 Voltage Detection 1 Circuit Electrical Characteristics

| Symbol | Parameter | Condition | Standard | | | Unit |
|---------|--|---|----------|------|------|------|
| | | | Min. | Typ. | Max. | |
| Vdet1 | Voltage detection level Vdet1_0 ⁽²⁾ | At the falling of Vcc | 2.00 | 2.20 | 2.40 | V |
| | Voltage detection level Vdet1_1 ⁽²⁾ | At the falling of Vcc | 2.15 | 2.35 | 2.55 | V |
| | Voltage detection level Vdet1_2 ⁽²⁾ | At the falling of Vcc | 2.30 | 2.50 | 2.70 | V |
| | Voltage detection level Vdet1_3 ⁽²⁾ | At the falling of Vcc | 2.45 | 2.65 | 2.85 | V |
| | Voltage detection level Vdet1_4 ⁽²⁾ | At the falling of Vcc | 2.60 | 2.80 | 3.00 | V |
| | Voltage detection level Vdet1_5 ⁽²⁾ | At the falling of Vcc | 2.75 | 2.95 | 3.15 | V |
| | Voltage detection level Vdet1_6 ⁽²⁾ | At the falling of Vcc | 2.85 | 3.10 | 3.40 | V |
| | Voltage detection level Vdet1_7 ⁽²⁾ | At the falling of Vcc | 3.00 | 3.25 | 3.55 | V |
| | Voltage detection level Vdet1_8 ⁽²⁾ | At the falling of Vcc | 3.15 | 3.40 | 3.70 | V |
| | Voltage detection level Vdet1_9 ⁽²⁾ | At the falling of Vcc | 3.30 | 3.55 | 3.85 | V |
| | Voltage detection level Vdet1_A ⁽²⁾ | At the falling of Vcc | 3.45 | 3.70 | 4.00 | V |
| | Voltage detection level Vdet1_B ⁽²⁾ | At the falling of Vcc | 3.60 | 3.85 | 4.15 | V |
| | Voltage detection level Vdet1_C ⁽²⁾ | At the falling of Vcc | 3.75 | 4.00 | 4.30 | V |
| | Voltage detection level Vdet1_D ⁽²⁾ | At the falling of Vcc | 3.90 | 4.15 | 4.45 | V |
| | Voltage detection level Vdet1_E ⁽²⁾ | At the falling of Vcc | 4.05 | 4.30 | 4.60 | V |
| | Voltage detection level Vdet1_F ⁽²⁾ | At the falling of Vcc | 4.20 | 4.45 | 4.75 | V |
| — | Hysteresis width at the rising of Vcc in voltage detection 1 circuit | Vdet1_0 to Vdet1_5 selected | — | 0.07 | — | V |
| | | Vdet1_6 to Vdet1_F selected | — | 0.10 | — | V |
| — | Voltage detection 1 circuit response time ⁽³⁾ | At the falling of Vcc from 5.0 V to (Vdet1_0 – 0.1) V | — | 60 | 150 | μs |
| — | Voltage detection circuit self power consumption | VCA26 = 1, Vcc = 5.0 V | — | 1.7 | — | μA |
| td(E-A) | Waiting time until voltage detection circuit operation starts ⁽⁴⁾ | | — | — | 100 | μs |

Notes:

1. The measurement condition is Vcc = 1.8 to 5.5 V and Topr = –20 to 85 °C (N version)/–40 to 85 °C (D version).
2. Select the voltage detection level with bits VD1S0 to VD1S3 in the VD1LS register.
3. Time until the voltage monitor 1 interrupt request is generated after the voltage passes Vdet1.
4. Necessary time until the voltage detection circuit operates when setting to 1 again after setting the VCA26 bit in the VCA2 register to 0.

Table 5.10 Voltage Detection 2 Circuit Electrical Characteristics

| Symbol | Parameter | Condition | Standard | | | Unit |
|---------------------|--|---|----------|------|------|------|
| | | | Min. | Typ. | Max. | |
| Vdet2 | Voltage detection level Vdet2_0 | At the falling of Vcc | 3.70 | 4.00 | 4.30 | V |
| — | Hysteresis width at the rising of Vcc in voltage detection 2 circuit | | — | 0.10 | — | V |
| — | Voltage detection 2 circuit response time (2) | At the falling of Vcc from 5.0 V to (Vdet2_0 – 0.1) V | — | 20 | 150 | μs |
| — | Voltage detection circuit self power consumption | VCA27 = 1, Vcc = 5.0 V | — | 1.7 | — | μA |
| t _{d(E-A)} | Waiting time until voltage detection circuit operation starts (3) | | — | — | 100 | μs |

Notes:

1. The measurement condition is V_{CC} = 1.8 to 5.5 V and T_{opr} = –20 to 85 °C (N version)/–40 to 85 °C (D version).
2. Time until the voltage monitor 2 interrupt request is generated after the voltage passes V_{det2}.
3. Necessary time until the voltage detection circuit operates after setting to 1 again after setting the VCA27 bit in the VCA2 register to 0.

Table 5.11 Power-on Reset Circuit (2)

| Symbol | Parameter | Condition | Standard | | | Unit |
|------------------|----------------------------------|-----------|----------|------|--------|---------|
| | | | Min. | Typ. | Max. | |
| t _{rth} | External power Vcc rise gradient | (1) | 0 | — | 50,000 | mV/msec |

Notes:

1. The measurement condition is T_{opr} = –20 to 85 °C (N version)/–40 to 85 °C (D version), unless otherwise specified.
2. To use the power-on reset function, enable voltage monitor 0 reset by setting the LVDAS bit in the OFS register to 0.

**Figure 5.3 Power-on Reset Circuit Electrical Characteristics**

Table 5.12 High-speed On-Chip Oscillator Circuit Electrical Characteristics

| Symbol | Parameter | Condition | Standard | | | Unit |
|--------|--|--|----------|--------|--------|---------------|
| | | | Min. | Typ. | Max. | |
| — | High-speed on-chip oscillator frequency after reset | $V_{CC} = 1.8 \text{ V to } 5.5 \text{ V}$ $-20 \text{ }^{\circ}\text{C} \leq T_{opr} \leq 85 \text{ }^{\circ}\text{C}$ | 38.4 | 40 | 41.6 | MHz |
| | | $V_{CC} = 1.8 \text{ V to } 5.5 \text{ V}$ $-40 \text{ }^{\circ}\text{C} \leq T_{opr} \leq 85 \text{ }^{\circ}\text{C}$ | 38.0 | 40 | 42.0 | MHz |
| | High-speed on-chip oscillator frequency when the FRA4 register correction value is written into the FRA1 register and the FRA5 register correction value into the FRA3 register ⁽²⁾ | $V_{CC} = 1.8 \text{ V to } 5.5 \text{ V}$ $-20 \text{ }^{\circ}\text{C} \leq T_{opr} \leq 85 \text{ }^{\circ}\text{C}$ | 35.389 | 36.864 | 38.338 | MHz |
| | | $V_{CC} = 1.8 \text{ V to } 5.5 \text{ V}$ $-40 \text{ }^{\circ}\text{C} \leq T_{opr} \leq 85 \text{ }^{\circ}\text{C}$ | 35.020 | 36.864 | 38.707 | MHz |
| | High-speed on-chip oscillator frequency when the FRA6 register correction value is written into the FRA1 register and the FRA7 register correction value into the FRA3 register | $V_{CC} = 1.8 \text{ V to } 5.5 \text{ V}$ $-20 \text{ }^{\circ}\text{C} \leq T_{opr} \leq 85 \text{ }^{\circ}\text{C}$ | 30.72 | 32 | 33.28 | MHz |
| | | $V_{CC} = 1.8 \text{ V to } 5.5 \text{ V}$ $-40 \text{ }^{\circ}\text{C} \leq T_{opr} \leq 85 \text{ }^{\circ}\text{C}$ | 30.40 | 32 | 33.60 | MHz |
| — | Oscillation stability time | $V_{CC} = 5.0 \text{ V}, T_{opr} = 25 \text{ }^{\circ}\text{C}$ | — | 0.5 | 3 | ms |
| — | Self power consumption at oscillation | $V_{CC} = 5.0 \text{ V}, T_{opr} = 25 \text{ }^{\circ}\text{C}$ | — | 400 | — | μA |

Notes:

- $V_{CC} = 1.8$ to 5.5 V and $T_{opr} = -20$ to $85 \text{ }^{\circ}\text{C}$ (N version)/ -40 to $85 \text{ }^{\circ}\text{C}$ (D version), unless otherwise specified.
- This enables the setting errors of bit rates such as 9600 bps and 38400 bps to be 0% when the serial interface is used in UART mode.

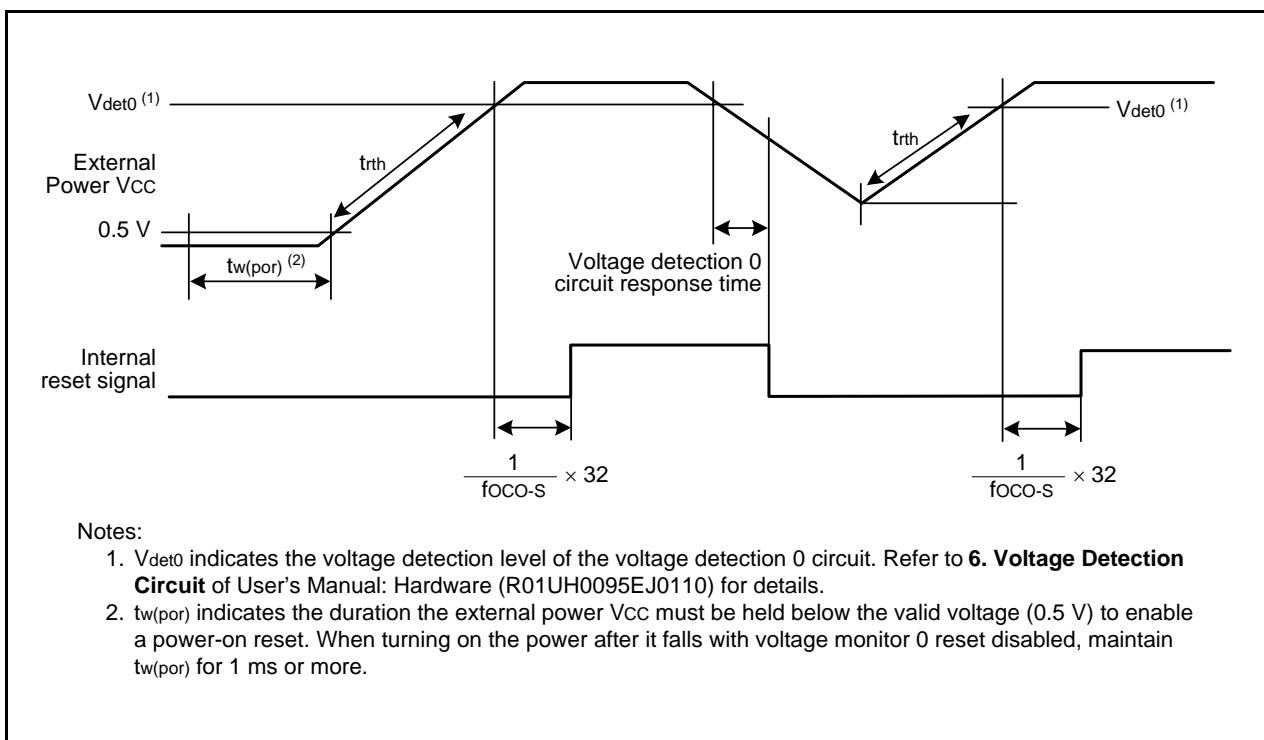
Table 5.13 Low-speed On-Chip Oscillator Circuit Electrical Characteristics

| Symbol | Parameter | Condition | Standard | | | Unit |
|--------|--|---|----------|------|------|---------------|
| | | | Min. | Typ. | Max. | |
| fOCO-S | Low-speed on-chip oscillator frequency | | 60 | 125 | 250 | kHz |
| — | Oscillation stability time | $V_{CC} = 5.0 \text{ V}, T_{opr} = 25 \text{ }^{\circ}\text{C}$ | — | 30 | 100 | μs |
| — | Self power consumption at oscillation | $V_{CC} = 5.0 \text{ V}, T_{opr} = 25 \text{ }^{\circ}\text{C}$ | — | 2 | — | μA |

Note:

- $V_{CC} = 1.8$ to 5.5 V and $T_{opr} = -20$ to $85 \text{ }^{\circ}\text{C}$ (N version)/ -40 to $85 \text{ }^{\circ}\text{C}$ (D version), unless otherwise specified.

Table 5.14 Power Supply Circuit Timing Characteristics

| Symbol | Parameter | Condition | Standard | | | Unit |
|--------------|---|-----------|----------|------|-------|---------------|
| | | | Min. | Typ. | Max. | |
| $t_{d(P-R)}$ | Time for internal power supply stabilization during power-on ⁽²⁾ | | — | — | 2,000 | μs |

Notes:

- The measurement condition is $V_{CC} = 1.8$ to 5.5 V and $T_{opr} = 25 \text{ }^{\circ}\text{C}$.
- Waiting time until the internal power supply generation circuit stabilizes during power-on.

Table 5.15 Timing Requirements of Synchronous Serial Communication Unit (SSU)

| Symbol | Parameter | | Conditions | Standard | | | Unit |
|--------|---------------------------------|--------|---------------------|------------|------|---------------|----------|
| | | | | Min. | Typ. | Max. | |
| tsucyc | SSCK clock cycle time | | | 4 | — | — | tcyc (2) |
| tHI | SSCK clock "H" width | | | 0.4 | — | 0.6 | tsucyc |
| tLO | SSCK clock "L" width | | | 0.4 | — | 0.6 | tsucyc |
| tRISE | SSCK clock rising time | Master | | — | — | 1 | tcyc (2) |
| | | Slave | | — | — | 1 | μs |
| tFALL | SSCK clock falling time | Master | | — | — | 1 | tcyc (2) |
| | | Slave | | — | — | 1 | μs |
| tsu | SSO, SSI data input setup time | | | 100 | — | — | ns |
| tH | SSO, SSI data input hold time | | | 1 | — | — | tcyc (2) |
| tLEAD | SCS setup time | Slave | | 1tcyc + 50 | — | — | ns |
| tLAG | SCS hold time | Slave | | 1tcyc + 50 | — | — | ns |
| tOD | SSO, SSI data output delay time | | | — | — | 1 | tcyc (2) |
| tSA | SSI slave access time | | 2.7 V ≤ Vcc ≤ 5.5 V | — | — | 1.5tcyc + 100 | ns |
| | | | 1.8 V ≤ Vcc < 2.7 V | — | — | 1.5tcyc + 200 | ns |
| tOR | SSI slave out open time | | 2.7 V ≤ Vcc ≤ 5.5 V | — | — | 1.5tcyc + 100 | ns |
| | | | 1.8 V ≤ Vcc < 2.7 V | — | — | 1.5tcyc + 200 | ns |

Notes:

1. Vcc = 1.8 to 5.5 V, Vss = 0 V, and Topr = -20 to 85 °C (N version)/-40 to 85 °C (D version), unless otherwise specified.
2. 1tcyc = 1/f1(s)

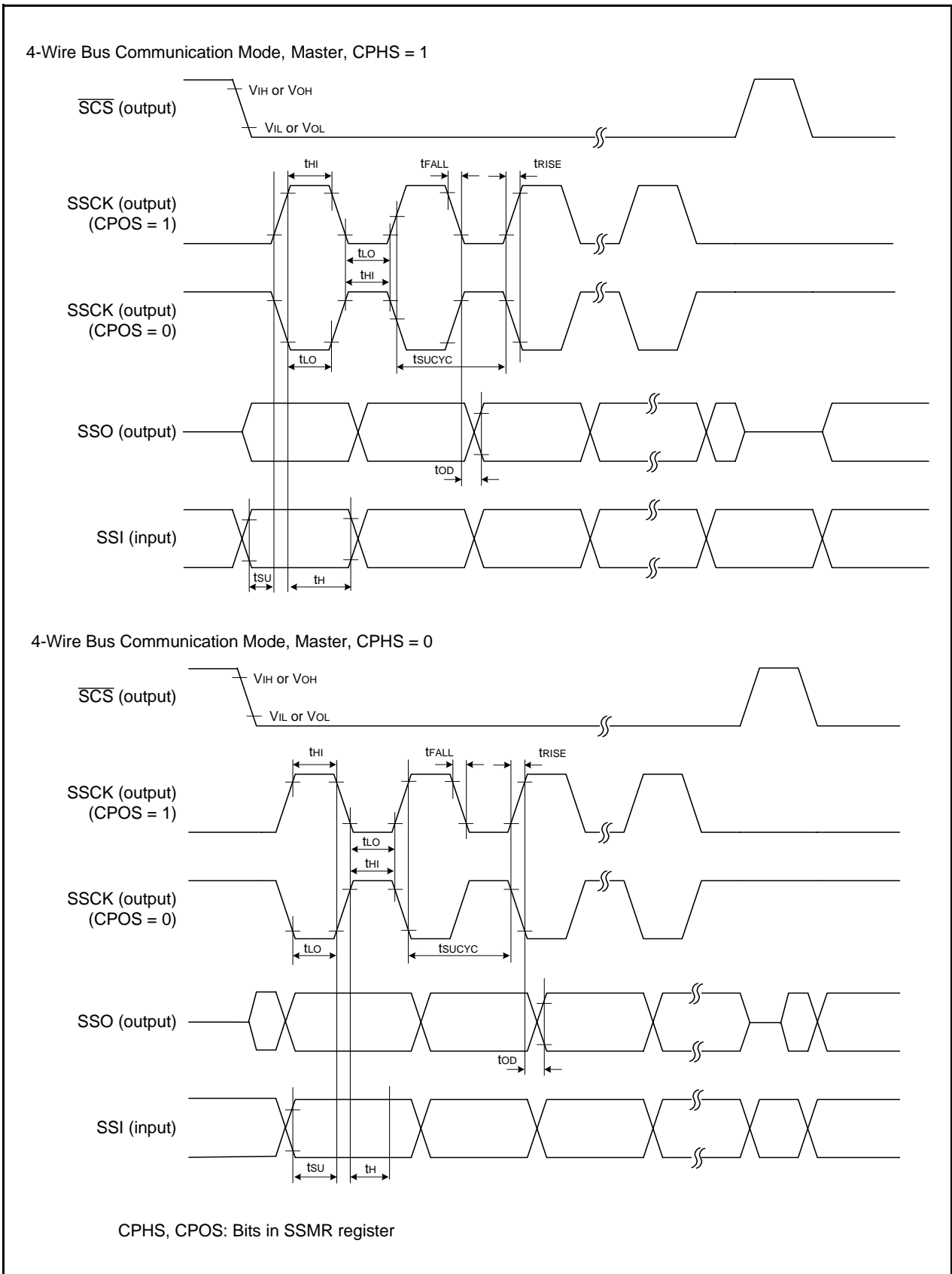

Figure 5.4 I/O Timing of Synchronous Serial Communication Unit (SSU) (Master)

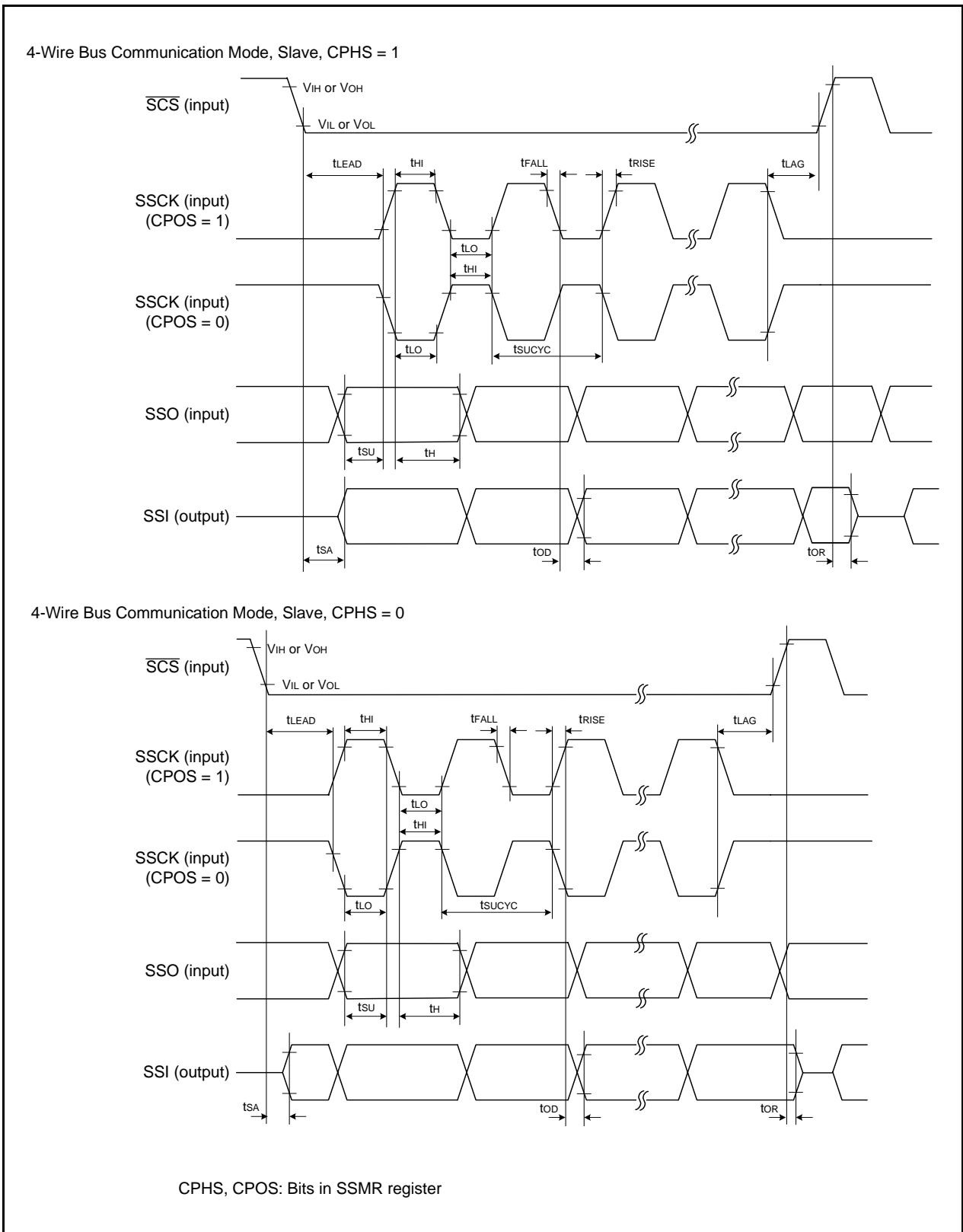

Figure 5.5 I/O Timing of Synchronous Serial Communication Unit (SSU) (Slave)

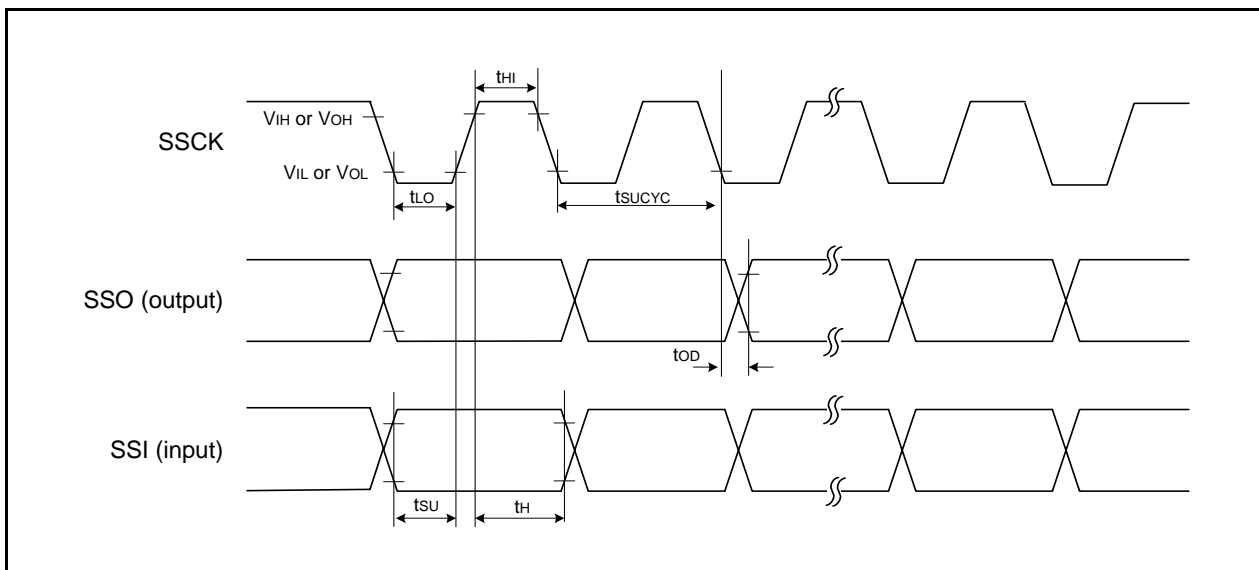

Figure 5.6 I/O Timing of Synchronous Serial Communication Unit (SSU) (Clock Synchronous Communication Mode)

Table 5.16 Timing Requirements of I²C bus Interface

| Symbol | Parameter | Condition | Standard | | | Unit |
|-------------------|---|-----------|---|------|----------------------------------|------|
| | | | Min. | Typ. | Max. | |
| t _{SCL} | SCL input cycle time | | 12t _{CYC} + 600 ⁽²⁾ | — | — | ns |
| t _{SCLH} | SCL input "H" width | | 3t _{CYC} + 300 ⁽²⁾ | — | — | ns |
| t _{SCLL} | SCL input "L" width | | 5t _{CYC} + 500 ⁽²⁾ | — | — | ns |
| t _{Sf} | SCL, SDA input fall time | | — | — | 300 | ns |
| t _{SP} | SCL, SDA input spike pulse rejection time | | — | — | 1t _{CYC} ⁽²⁾ | ns |
| t _{BUF} | SDA input bus-free time | | 5t _{CYC} ⁽²⁾ | — | — | ns |
| t _{STAH} | Start condition input hold time | | 3t _{CYC} ⁽²⁾ | — | — | ns |
| t _{STAS} | Retransmit start condition input setup time | | 3t _{CYC} ⁽²⁾ | — | — | ns |
| t _{STOP} | Stop condition input setup time | | 3t _{CYC} ⁽²⁾ | — | — | ns |
| t _{SDAS} | Data input setup time | | 1t _{CYC} + 40 ⁽²⁾ | — | — | ns |
| t _{SDAH} | Data input hold time | | 10 | — | — | ns |

Notes:

1. V_{CC} = 1.8 to 5.5 V, V_{SS} = 0 V, and T_{opr} = -20 to 85 °C (N version)/-40 to 85 °C (D version), unless otherwise specified.
2. 1t_{CYC} = 1/f₁(s)

**Figure 5.7 I/O Timing of I²C bus Interface**

Table 5.17 Electrical Characteristics (1) [4.2 V ≤ Vcc ≤ 5.5 V]

| Symbol | Parameter | | Condition | | Standard | | | Unit |
|----------------------------------|---------------------|---|---|---------------------------|-----------------------|------|-----------------|------|
| | | | | | Min. | Typ. | Max. | |
| V _{OH} | Output "H" voltage | Other than XOUT | Drive capacity High V _{cc} = 5 V | I _{OH} = -20 mA | V _{cc} - 2.0 | — | V _{cc} | V |
| | | | Drive capacity Low V _{cc} = 5 V | I _{OH} = -5 mA | V _{cc} - 2.0 | — | V _{cc} | V |
| | | XOUT | V _{cc} = 5 V | I _{OH} = -200 μA | 1.0 | — | V _{cc} | V |
| V _{OL} | Output "L" voltage | Other than XOUT | Drive capacity High V _{cc} = 5 V | I _{OL} = 20 mA | — | — | 2.0 | V |
| | | | Drive capacity Low V _{cc} = 5 V | I _{OL} = 5 mA | — | — | 2.0 | V |
| | | XOUT | V _{cc} = 5 V | I _{OL} = 200 μA | — | — | 0.5 | V |
| V _{T+} -V _{T-} | Hysteresis | INT0, INT1, INT2, INT3, INT4, KI0, KI1, KI2, KI3, TRAIO, TRBO, TRCIOA, TRCIOB, TRCIOC, TRCIOD, TRDIOA0, TRDIOB0, TRDIOC0, TRDIOD0, TRDIOA1, TRDIOB1, TRDIOC1, TRDIOD1, TRCTRG, TRCCLK, TRFI, TRGIOA, TRGIOB, ADTRG, RXD0, RXD1, RXD2, CLK0, CLK1, CLK2, SSI, SCL, SDA, SSO | | | 0.1 | 1.2 | — | V |
| | | RESET | | | 0.1 | 1.2 | — | V |
| I _{IH} | Input "H" current | | V _I = 5 V, V _{cc} = 5.0 V | | — | — | 5.0 | μA |
| I _{IL} | Input "L" current | | V _I = 0 V, V _{cc} = 5.0 V | | — | — | -5.0 | μA |
| R _{PULLUP} | Pull-up resistance | | V _I = 0 V, V _{cc} = 5.0 V | | 25 | 50 | 100 | kΩ |
| R _{fXIN} | Feedback resistance | XIN | | | — | 0.3 | — | MΩ |
| R _{fXCIN} | Feedback resistance | XCIN | | | — | 8 | — | MΩ |
| V _{RAM} | RAM hold voltage | | During stop mode | | 1.8 | — | — | V |

Note:

- 4.2 V ≤ V_{cc} ≤ 5.5 V, T_{opr} = -20 to 85 °C (N version)/-40 to 85 °C (D version), and f(XIN) = 20 MHz, unless otherwise specified.

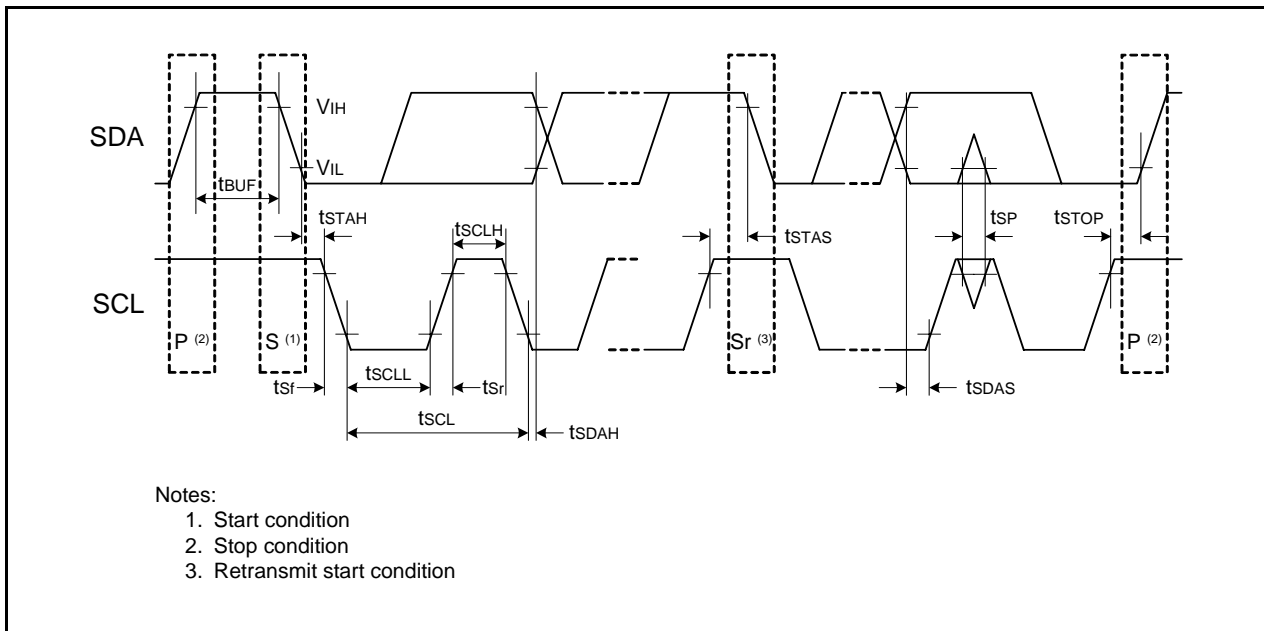
Table 5.18 Electrical Characteristics (2) [3.3 V ≤ Vcc ≤ 5.5 V]
(Topr = −20 to 85 °C (N version)/−40 to 85 °C (D version), unless otherwise specified.)

| Symbol | Parameter | Condition | Standard | | | Unit | |
|--------|---|---|--|---|------|------|----|
| | | | Min. | Typ. | Max. | | |
| Icc | Power supply current (Vcc = 3.3 to 5.5 V) Single-chip mode, output pins are open, other pins are Vss | High-speed clock mode | XIN = 20 MHz (square wave) High-speed on-chip oscillator off Low-speed on-chip oscillator on = 125 kHz No division | — | 6.5 | 15 | mA |
| | | | XIN = 16 MHz (square wave) High-speed on-chip oscillator off Low-speed on-chip oscillator on = 125 kHz No division | — | 5.3 | 12.5 | mA |
| | | | XIN = 10 MHz (square wave) High-speed on-chip oscillator off Low-speed on-chip oscillator on = 125 kHz No division | — | 3.6 | — | mA |
| | | | XIN = 20 MHz (square wave) High-speed on-chip oscillator off Low-speed on-chip oscillator on = 125 kHz Divide-by-8 | — | 3.0 | — | mA |
| | | | XIN = 16 MHz (square wave) High-speed on-chip oscillator off Low-speed on-chip oscillator on = 125 kHz Divide-by-8 | — | 2.2 | — | mA |
| | | | XIN = 10 MHz (square wave) High-speed on-chip oscillator off Low-speed on-chip oscillator on = 125 kHz Divide-by-8 | — | 1.5 | — | mA |
| | | | High-speed on-chip oscillator mode | XIN clock off High-speed on-chip oscillator on fOCO-F = 20 MHz Low-speed on-chip oscillator on = 125 kHz No division | — | 7.0 | 15 |
| | | XIN clock off High-speed on-chip oscillator on fOCO-F = 20 MHz Low-speed on-chip oscillator on = 125 kHz Divide-by-8 | | — | 3.0 | — | mA |
| | | XIN clock off High-speed on-chip oscillator on fOCO-F = 4 MHz Low-speed on-chip oscillator on = 125 kHz Divide-by-16, MSTIIC = MSTTRD = MSTTRC = 1 | | — | 1 | — | mA |
| | | Low-speed on-chip oscillator mode | XIN clock off High-speed on-chip oscillator off Low-speed on-chip oscillator on = 125 kHz Divide-by-8, FMR27 = 1, VCA20 = 0 | — | 90 | 400 | μA |
| | | Low-speed clock mode | XIN clock off High-speed on-chip oscillator off Low-speed on-chip oscillator off XCIN clock oscillator on = 32 kHz No division FMR27 = 1, VCA20 = 0 | — | 85 | 400 | μA |
| | | | XIN clock off High-speed on-chip oscillator off Low-speed on-chip oscillator off XCIN clock oscillator on = 32 kHz No division | — | 47 | — | μA |
| | | | Program operation on RAM Flash memory off, FMSTP = 1, VCA20 = 0 | — | — | — | — |
| | | Wait mode | XIN clock off High-speed on-chip oscillator off Low-speed on-chip oscillator on = 125 kHz While a WAIT instruction is executed Peripheral clock operation VCA27 = VCA26 = VCA25 = 0, VCA20 = 1 | — | 15 | 100 | μA |
| | | | XIN clock off High-speed on-chip oscillator off Low-speed on-chip oscillator on = 125 kHz While a WAIT instruction is executed Peripheral clock off VCA27 = VCA26 = VCA25 = 0, VCA20 = 1 | — | 4 | 90 | μA |
| | | | XIN clock off High-speed on-chip oscillator off Low-speed on-chip oscillator off XCIN clock oscillator on = 32 kHz (peripheral clock off) While a WAIT instruction is executed VCA27 = VCA26 = VCA25 = 0, VCA20 = 1 | — | 3.5 | — | μA |
| | | Stop mode | XIN clock off, Topr = 25 °C High-speed on-chip oscillator off Low-speed on-chip oscillator off CM10 = 1 Peripheral clock off VCA27 = VCA26 = VCA25 = 0 | — | 2.0 | 5.0 | μA |
| | | | XIN clock off, Topr = 85 °C High-speed on-chip oscillator off Low-speed on-chip oscillator off CM10 = 1 Peripheral clock off VCA27 = VCA26 = VCA25 = 0 | — | 15 | — | μA |

Timing Requirements (Unless Otherwise Specified: $V_{CC} = 5\text{ V}$, $V_{SS} = 0\text{ V}$, $T_{opr} = 25\text{ }^{\circ}\text{C}$)**Table 5.19 External Clock Input (XOUT, XCIN)**

| Symbol | Parameter | Standard | | Unit |
|-----------------------|-----------------------|----------|------|---------------|
| | | Min. | Max. | |
| $t_c(\text{XOUT})$ | XOUT input cycle time | 50 | — | ns |
| $t_{WH}(\text{XOUT})$ | XOUT input "H" width | 24 | — | ns |
| $t_{WL}(\text{XOUT})$ | XOUT input "L" width | 24 | — | ns |
| $t_c(\text{XCIN})$ | XCIN input cycle time | 14 | — | μs |
| $t_{WH}(\text{XCIN})$ | XCIN input "H" width | 7 | — | μs |
| $t_{WL}(\text{XCIN})$ | XCIN input "L" width | 7 | — | μs |

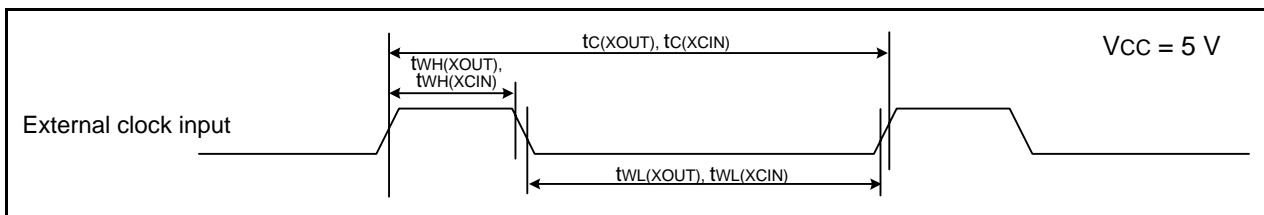
**Figure 5.8 External Clock Input Timing Diagram when $V_{CC} = 5\text{ V}$** **Table 5.20 TRAIO Input**

| Symbol | Parameter | Standard | | Unit |
|------------------------|------------------------|----------|------|------|
| | | Min. | Max. | |
| $t_c(\text{TRAIO})$ | TRAIO input cycle time | 100 | — | ns |
| $t_{WH}(\text{TRAIO})$ | TRAIO input "H" width | 40 | — | ns |
| $t_{WL}(\text{TRAIO})$ | TRAIO input "L" width | 40 | — | ns |

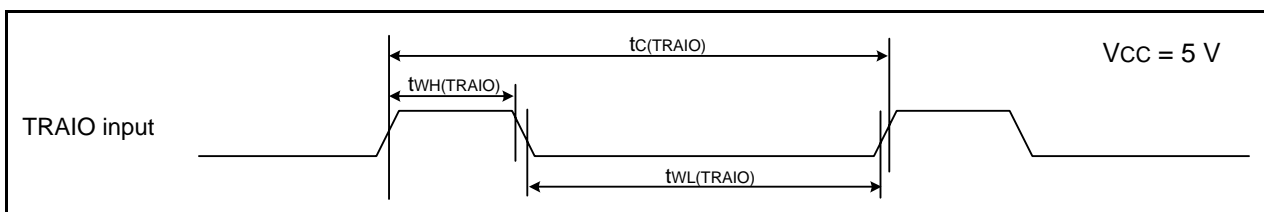
**Figure 5.9 TRAIO Input Timing Diagram when $V_{CC} = 5\text{ V}$** **Table 5.21 TRFI Input**

| Symbol | Parameter | Standard | | Unit |
|-----------------------|-----------------------|----------|------|------|
| | | Min. | Max. | |
| $t_c(\text{TRFI})$ | TRFI input cycle time | 400 (1) | — | ns |
| $t_{WH}(\text{TRFI})$ | TRFI input "H" width | 200 (2) | — | ns |
| $t_{WL}(\text{TRFI})$ | TRFI input "L" width | 200 (2) | — | ns |

Notes:

1. When using timer RF input capture mode, adjust the cycle time to $(1/\text{timer RF count source frequency} \times 3)$ or above.
2. When using timer RF input capture mode, adjust the pulse width to $(1/\text{timer RF count source frequency} \times 1.5)$ or above.

**Figure 5.10 TRFI Input Timing Diagram when $V_{CC} = 5\text{ V}$**

Table 5.22 Serial Interface

| Symbol | Parameter | Standard | | Unit |
|---------------|------------------------|----------|------|------|
| | | Min. | Max. | |
| $t_{c(CK)}$ | CLKi input cycle time | 200 | — | ns |
| $t_{w(CKH)}$ | CLKi input "H" width | 100 | — | ns |
| $t_{w(CKL)}$ | CLKi input "L" width | 100 | — | ns |
| $t_{d(C-Q)}$ | TXDi output delay time | — | 50 | ns |
| $t_{h(C-Q)}$ | TXDi hold time | 0 | — | ns |
| $t_{su(D-C)}$ | RXDi input setup time | 50 | — | ns |
| $t_{h(C-D)}$ | RXDi input hold time | 90 | — | ns |

i = 0 to 2

**Figure 5.11 Serial Interface Timing Diagram when Vcc = 5 V****Table 5.23 External Interrupt \overline{INTi} (i = 0 to 4) Input, Key Input Interrupt \overline{Kli} (i = 0 to 3)**

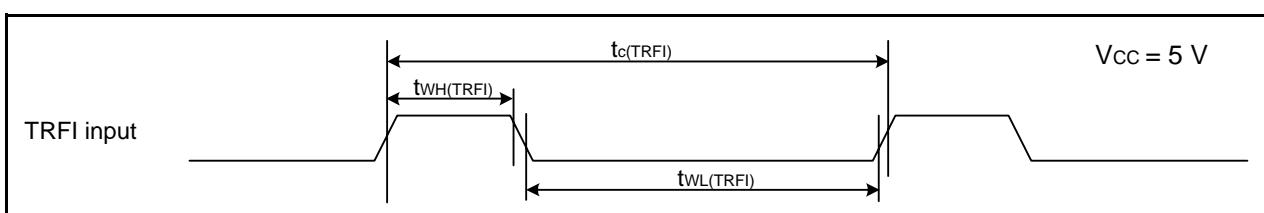
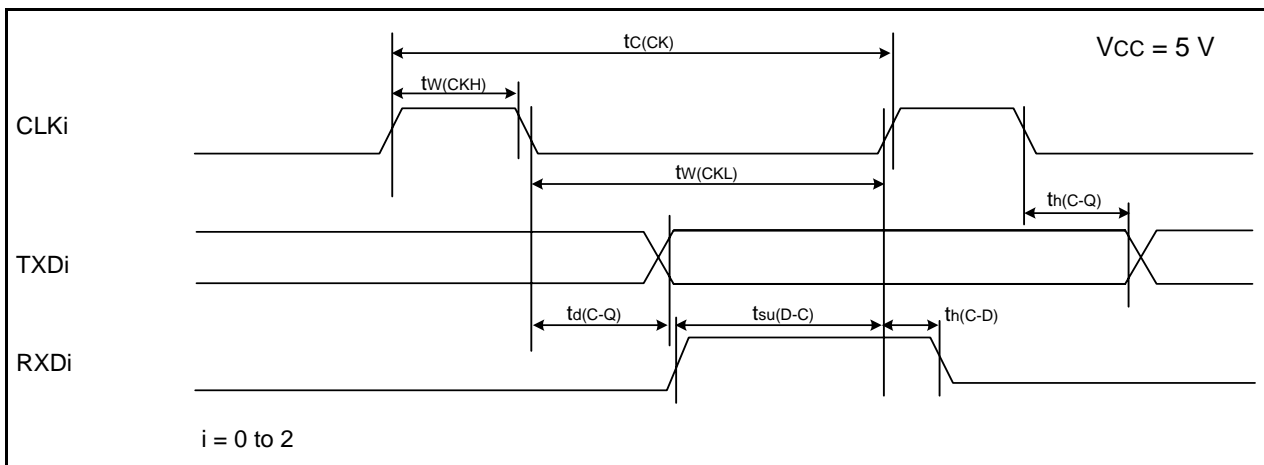
| Symbol | Parameter | Standard | | Unit |
|--------------|---|--------------------|------|------|
| | | Min. | Max. | |
| $t_{w(INH)}$ | \overline{INTi} input "H" width, \overline{Kli} input "H" width | 250 ⁽¹⁾ | — | ns |
| $t_{w(INL)}$ | \overline{INTi} input "L" width, \overline{Kli} input "L" width | 250 ⁽²⁾ | — | ns |

Notes:

1. When selecting the digital filter by the \overline{INTi} input filter select bit, use an \overline{INTi} input HIGH width of either (1/digital filter clock frequency × 3) or the minimum value of standard, whichever is greater.
2. When selecting the digital filter by the \overline{INTi} input filter select bit, use an \overline{INTi} input LOW width of either (1/digital filter clock frequency × 3) or the minimum value of standard, whichever is greater.

**Figure 5.12 Input Timing Diagram for External Interrupt \overline{INTi} and Key Input Interrupt \overline{Kli} when Vcc = 5 V**

Table 5.24 Electrical Characteristics (3) [2.7 V ≤ V_{CC} < 4.2 V]

| Symbol | Parameter | | Condition | Standard | | | Unit | |
|----------------------------------|---------------------|---|---|-------------------------|-----------------------|-----------------|-----------------|----|
| | | | | Min. | Typ. | Max. | | |
| V _{OH} | Output "H" voltage | Other than XOUT | Drive capacity High | I _{OH} = -5 mA | V _{CC} - 0.5 | — | V _{CC} | V |
| | | | Drive capacity Low | I _{OH} = -1 mA | V _{CC} - 0.5 | — | V _{CC} | V |
| | | XOUT | I _{OH} = -200 μA | 1.0 | — | V _{CC} | V | |
| V _{OL} | Output "L" voltage | Other than XOUT | Drive capacity High | I _{OL} = 5 mA | — | — | 0.5 | V |
| | | | Drive capacity Low | I _{OL} = 1 mA | — | — | 0.5 | V |
| | | XOUT | I _{OL} = 200 μA | — | — | 0.5 | V | |
| V _{T+} -V _{T-} | Hysteresis | INT0, INT1, INT2, INT3, INT4, KI0, KI1, KI2, KI3, TRAIO, TRBO, TRCIOA, TRCIOB, TRCIOC, TRCIOD, TRDIOA0, TRDIOB0, TRDIOC0, TRDIOD0, TRDIOA1, TRDIOB1, TRDIOC1, TRDIOD1, TRCTRG, TRCCLK, TRFI, TRGIOA, TRGIOB, ADTRG, RXD0, RXD1, RXD2, CLK0, CLK1, CLK2, SSI, SCL, SDA, SSO | V _{CC} = 3.0 V | 0.1 | 0.4 | — | V | |
| | | RESET | V _{CC} = 3.0 V | 0.1 | 0.5 | — | V | |
| I _{IH} | Input "H" current | | V _I = 3 V, V _{CC} = 3.0 V | | — | — | 4.0 | μA |
| I _{IL} | Input "L" current | | V _I = 0 V, V _{CC} = 3.0 V | | — | — | -4.0 | μA |
| R _{PULLUP} | Pull-up resistance | | V _I = 0 V, V _{CC} = 3.0 V | | 42 | 84 | 168 | kΩ |
| R _{iXIN} | Feedback resistance | XIN | | | — | 0.3 | — | MΩ |
| R _{iXCIN} | Feedback resistance | XCIN | | | — | 8 | — | MΩ |
| V _{RAM} | RAM hold voltage | | During stop mode | | 1.8 | — | — | V |

Note:

- 2.7 V ≤ V_{CC} < 4.2 V, T_{opr} = -20 to 85 °C (N version)/-40 to 85 °C (D version), and f(XIN) = 10 MHz, unless otherwise specified.

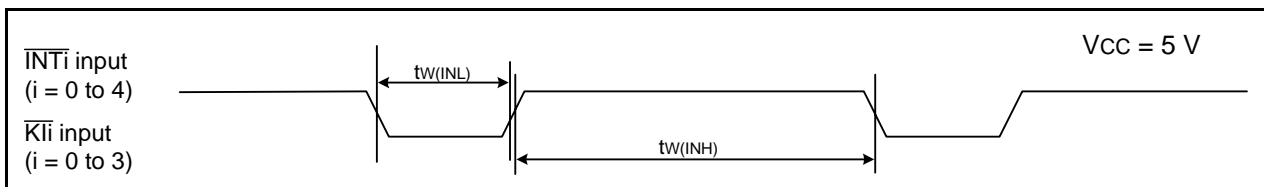
**Table 5.25 Electrical Characteristics (4) [2.7 V ≤ Vcc ≤ 3.3 V]
(Topr = −20 to 85 °C (N version)/−40 to 85 °C (D version), unless otherwise specified.)**

| Symbol | Parameter | Condition | Standard | | | Unit | |
|--------|---|------------------------------------|--|------|------|------|----|
| | | | Min. | Typ. | Max. | | |
| Icc | Power supply current (Vcc = 2.7 to 3.3 V) Single-chip mode, output pins are open, other pins are Vss | High-speed clock mode | XIN = 10 MHz (square wave) High-speed on-chip oscillator off Low-speed on-chip oscillator on = 125 kHz No division | — | 3.5 | 10 | mA |
| | | | XIN = 10 MHz (square wave) High-speed on-chip oscillator off Low-speed on-chip oscillator on = 125 kHz Divide-by-8 | — | 1.5 | 7.5 | mA |
| | | High-speed on-chip oscillator mode | XIN clock off High-speed on-chip oscillator on fOCO-F = 20 MHz Low-speed on-chip oscillator on = 125 kHz No division | — | 7.0 | 15 | mA |
| | | | XIN clock off High-speed on-chip oscillator on fOCO-F = 20 MHz Low-speed on-chip oscillator on = 125 kHz Divide-by-8 | — | 3.0 | — | mA |
| | | | XIN clock off High-speed on-chip oscillator on fOCO-F = 10 MHz Low-speed on-chip oscillator on = 125 kHz No division | — | 4.0 | — | mA |
| | | | XIN clock off High-speed on-chip oscillator on fOCO-F = 10 MHz Low-speed on-chip oscillator on = 125 kHz Divide-by-8 | — | 1.5 | — | mA |
| | | | XIN clock off High-speed on-chip oscillator on fOCO-F = 4 MHz Low-speed on-chip oscillator on = 125 kHz Divide-by-16, MSTIIC = MSTTRD = MSTTRC = 1 | — | 1 | — | mA |
| | | Low-speed on-chip oscillator mode | XIN clock off High-speed on-chip oscillator off Low-speed on-chip oscillator on = 125 kHz Divide-by-8, FMR27 = 1, VCA20 = 0 | — | 90 | 390 | μA |
| | | Low-speed clock mode | XIN clock off High-speed on-chip oscillator off Low-speed on-chip oscillator off XCIN clock oscillator on = 32 kHz No division FMR27 = 1, VCA20 = 0 | — | 80 | 400 | μA |
| | | | XIN clock off High-speed on-chip oscillator off Low-speed on-chip oscillator off XCIN clock oscillator on = 32 kHz No division Program operation on RAM Flash memory off, FMSTP = 1, VCA20 = 0 | — | 40 | — | μA |
| | | | XIN clock off High-speed on-chip oscillator off Low-speed on-chip oscillator off XCIN clock oscillator on = 32 kHz (peripheral clock off) While a WAIT instruction is executed VCA27 = VCA26 = VCA25 = 0, VCA20 = 1 | — | 3.5 | — | μA |
| | | Wait mode | XIN clock off High-speed on-chip oscillator off Low-speed on-chip oscillator on = 125 kHz While a WAIT instruction is executed Peripheral clock operation VCA27 = VCA26 = VCA25 = 0, VCA20 = 1 | — | 15 | 90 | μA |
| | | | XIN clock off High-speed on-chip oscillator off Low-speed on-chip oscillator on = 125 kHz While a WAIT instruction is executed Peripheral clock off VCA27 = VCA26 = VCA25 = 0, VCA20 = 1 | — | 4 | 80 | μA |
| | | | XIN clock off High-speed on-chip oscillator off Low-speed on-chip oscillator off XCIN clock oscillator on = 32 kHz (peripheral clock off) While a WAIT instruction is executed VCA27 = VCA26 = VCA25 = 0, VCA20 = 1 | — | 3.5 | — | μA |
| | | Stop mode | XIN clock off, Topr = 25 °C High-speed on-chip oscillator off Low-speed on-chip oscillator off CM10 = 1 Peripheral clock off VCA27 = VCA26 = VCA25 = 0 | — | 2.0 | 5.0 | μA |
| | | | XIN clock off, Topr = 85 °C High-speed on-chip oscillator off Low-speed on-chip oscillator off CM10 = 1 Peripheral clock off VCA27 = VCA26 = VCA25 = 0 | — | 15 | — | μA |

Timing requirements (Unless Otherwise Specified: $V_{CC} = 3\text{ V}$, $V_{SS} = 0\text{ V}$, $T_{opr} = 25\text{ }^{\circ}\text{C}$)**Table 5.26 External Clock Input (XOUT, XCIN)**

| Symbol | Parameter | Standard | | Unit |
|-----------------------|-----------------------|----------|------|---------------|
| | | Min. | Max. | |
| $t_c(\text{XOUT})$ | XOUT input cycle time | 50 | — | ns |
| $t_{WH}(\text{XOUT})$ | XOUT input "H" width | 24 | — | ns |
| $t_{WL}(\text{XOUT})$ | XOUT input "L" width | 24 | — | ns |
| $t_c(\text{XCIN})$ | XCIN input cycle time | 14 | — | μs |
| $t_{WH}(\text{XCIN})$ | XCIN input "H" width | 7 | — | μs |
| $t_{WL}(\text{XCIN})$ | XCIN input "L" width | 7 | — | μs |

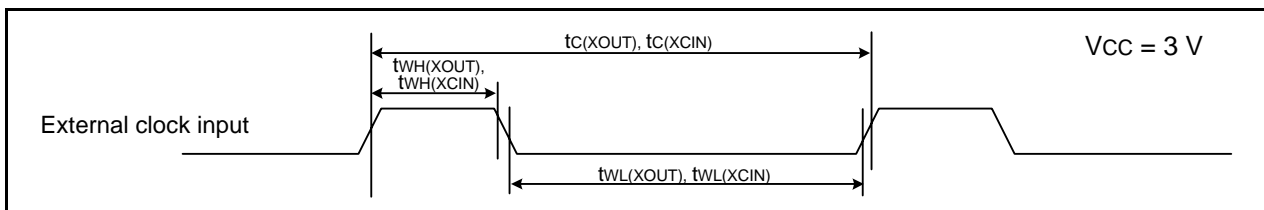
**Figure 5.13 External Clock Input Timing Diagram when $V_{CC} = 3\text{ V}$** **Table 5.27 TRAI0 Input**

| Symbol | Parameter | Standard | | Unit |
|------------------------|------------------------|----------|------|------|
| | | Min. | Max. | |
| $t_c(\text{TRAIO})$ | TRAIO input cycle time | 300 | — | ns |
| $t_{WH}(\text{TRAIO})$ | TRAIO input "H" width | 120 | — | ns |
| $t_{WL}(\text{TRAIO})$ | TRAIO input "L" width | 120 | — | ns |

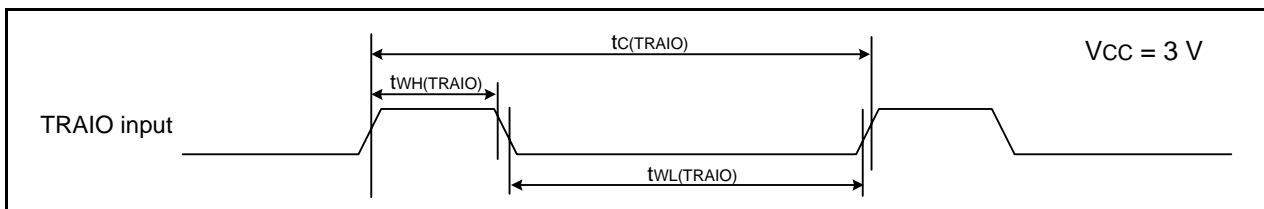
**Figure 5.14 TRAI0 Input Timing Diagram when $V_{CC} = 3\text{ V}$** **Table 5.28 TRFI Input**

| Symbol | Parameter | Standard | | Unit |
|-----------------------|-----------------------|----------|------|------|
| | | Min. | Max. | |
| $t_c(\text{TRFI})$ | TRFI input cycle time | 1200 (1) | — | ns |
| $t_{WH}(\text{TRFI})$ | TRFI input "H" width | 600 (2) | — | ns |
| $t_{WL}(\text{TRFI})$ | TRFI input "L" width | 600 (2) | — | ns |

Notes:

1. When using timer RF input capture mode, adjust the cycle time to $(1/\text{timer RF count source frequency} \times 3)$ or above.
2. When using timer RF input capture mode, adjust the pulse width to $(1/\text{timer RF count source frequency} \times 1.5)$ or above.

**Figure 5.15 TRFI Input Timing Diagram when $V_{CC} = 3\text{ V}$**

Table 5.29 Serial Interface

| Symbol | Parameter | Standard | | Unit |
|---------------|------------------------|----------|------|------|
| | | Min. | Max. | |
| $t_{c(CK)}$ | CLKi input cycle time | 300 | — | ns |
| $t_{w(CKH)}$ | CLKi input "H" width | 150 | — | ns |
| $t_{w(CKL)}$ | CLKi Input "L" width | 150 | — | ns |
| $t_{d(C-Q)}$ | TXDi output delay time | — | 80 | ns |
| $t_{h(C-Q)}$ | TXDi hold time | 0 | — | ns |
| $t_{su(D-C)}$ | RXDi input setup time | 70 | — | ns |
| $t_{h(C-D)}$ | RXDi input hold time | 90 | — | ns |

i = 0 to 2

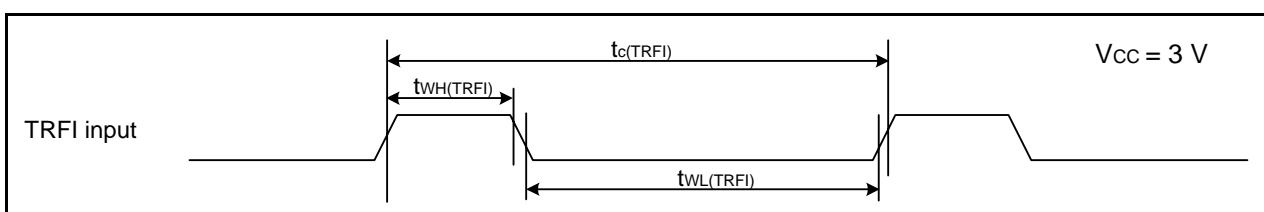
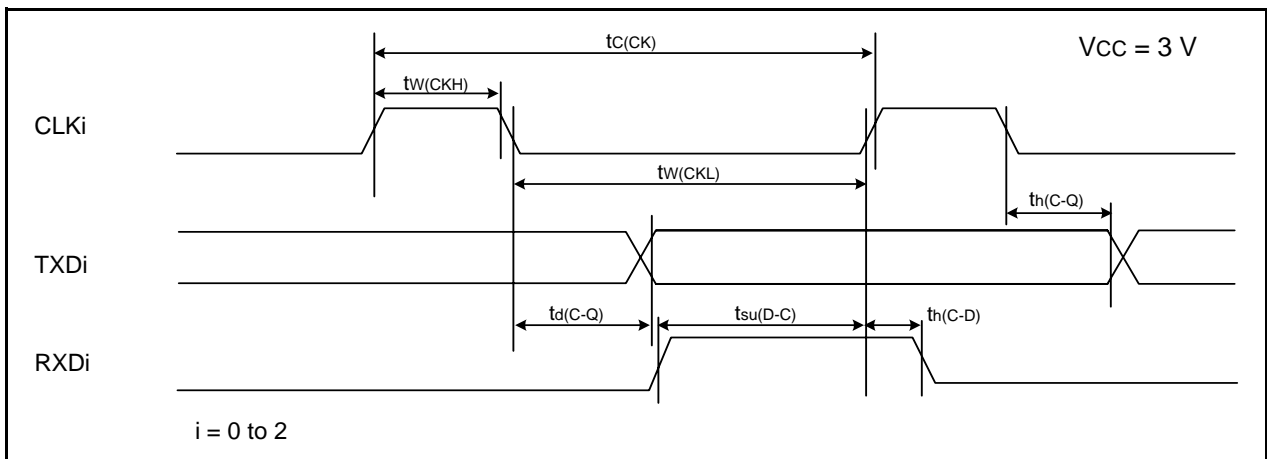

Figure 5.16 Serial Interface Timing Diagram when Vcc = 3 V

Table 5.30 External Interrupt \overline{INT}_i (i = 0 to 4) Input, Key Input Interrupt \overline{K}_i (i = 0 to 3)

| Symbol | Parameter | Standard | | Unit |
|--------------|--|----------|------|------|
| | | Min. | Max. | |
| $t_{w(INH)}$ | \overline{INT}_i input "H" width, \overline{K}_i input "H" width | 380 (1) | — | ns |
| $t_{w(INL)}$ | \overline{INT}_i input "L" width, \overline{K}_i input "L" width | 380 (2) | — | ns |

Notes:

1. When selecting the digital filter by the \overline{INT}_i input filter select bit, use an \overline{INT}_i input HIGH width of either (1/digital filter clock frequency × 3) or the minimum value of standard, whichever is greater.
2. When selecting the digital filter by the \overline{INT}_i input filter select bit, use an \overline{INT}_i input LOW width of either (1/digital filter clock frequency × 3) or the minimum value of standard, whichever is greater.

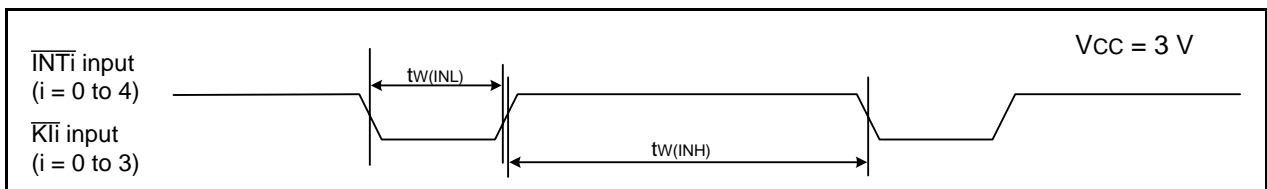

Figure 5.17 Input Timing Diagram for External Interrupt \overline{INT}_i and Key Input Interrupt \overline{K}_i when Vcc = 3 V

Table 5.31 Electrical Characteristics (5) [1.8 V ≤ V_{CC} < 2.7 V]

| Symbol | Parameter | | Condition | | Standard | | | Unit |
|----------------------------------|---------------------|---|---|-------------------------|-----------------------|-----------------|-----------------|------|
| | | | | | Min. | Typ. | Max. | |
| V _{OH} | Output "H" voltage | Other than XOUT | Drive capacity High | I _{OH} = -2 mA | V _{CC} - 0.5 | — | V _{CC} | V |
| | | | Drive capacity Low | I _{OH} = -1 mA | V _{CC} - 0.5 | — | V _{CC} | V |
| | | XOUT | I _{OH} = -200 μA | 1.0 | — | V _{CC} | V | |
| V _{OL} | Output "L" voltage | Other than XOUT | Drive capacity High | I _{OL} = 2 mA | — | — | 0.5 | V |
| | | | Drive capacity Low | I _{OL} = 1 mA | — | — | 0.5 | V |
| | | XOUT | I _{OL} = 200 μA | — | — | 0.5 | V | |
| V _{T+} -V _{T-} | Hysteresis | $\overline{\text{NT0}}, \overline{\text{INT1}}, \overline{\text{INT2}}, \overline{\text{INT3}}, \overline{\text{INT4}},$ $\overline{\text{KI0}}, \overline{\text{KI1}}, \overline{\text{KI2}}, \overline{\text{KI3}},$ $\overline{\text{TRAIO}}, \overline{\text{TRBO}},$ $\overline{\text{TRCIOA}}, \overline{\text{TRCIOB}},$ $\overline{\text{TRCIOC}}, \overline{\text{TRCIOD}},$ $\overline{\text{TRDIOA0}}, \overline{\text{TRDIOB0}},$ $\overline{\text{TRDIOC0}}, \overline{\text{TRDIOD0}},$ $\overline{\text{TRDIOA1}}, \overline{\text{TRDIOB1}},$ $\overline{\text{TRDIOC1}}, \overline{\text{TRDIOD1}},$ $\overline{\text{TRCTRG}}, \overline{\text{TRCCLK}},$ $\overline{\text{TRFI}}, \overline{\text{TRGIOA}},$ $\overline{\text{TRGIOB}}, \overline{\text{ADTRG}},$ $\overline{\text{RXD0}}, \overline{\text{RXD1}}, \overline{\text{RXD2}},$ $\overline{\text{CLK0}}, \overline{\text{CLK1}}, \overline{\text{CLK2}},$ $\overline{\text{SSI}}, \overline{\text{SCL}}, \overline{\text{SDA}}, \overline{\text{SSO}}$ | | | 0.05 | 0.20 | — | V |
| | | RESET | 0.05 | 0.20 | — | V | | |
| I _{IH} | Input "H" current | | V _I = 2.2 V, V _{CC} = 2.2 V | | — | — | 4.0 | μA |
| I _{IL} | Input "L" current | | V _I = 0 V, V _{CC} = 2.2 V | | — | — | -4.0 | μA |
| R _{PULLUP} | Pull-up resistance | | V _I = 0 V, V _{CC} = 2.2 V | | 70 | 140 | 300 | kΩ |
| R _{iXIN} | Feedback resistance | XIN | | | — | 0.3 | — | MΩ |
| R _{iXCIN} | Feedback resistance | XCIN | | | — | 8 | — | MΩ |
| V _{RAM} | RAM hold voltage | | During stop mode | | 1.8 | — | — | V |

Note:

- 1.8 V ≤ V_{CC} < 2.7 V, T_{opr} = -20 to 85 °C (N version)/-40 to 85 °C (D version), and f(XIN) = 5 MHz, unless otherwise specified.

Table 5.32 Electrical Characteristics (6) [1.8 V ≤ Vcc < 2.7 V]
(T_{opr} = -20 to 85 °C (N version)/-40 to 85 °C (D version), unless otherwise specified.)

| Symbol | Parameter | Condition | Standard | | | Unit | |
|-----------------|---|------------------------------------|--|------|------|------|----|
| | | | Min. | Typ. | Max. | | |
| I _{cc} | Power supply current (V _{cc} = 1.8 to 2.7 V) Single-chip mode, output pins are open, other pins are V _{ss} | High-speed clock mode | XIN = 5 MHz (square wave) High-speed on-chip oscillator off Low-speed on-chip oscillator on = 125 kHz No division | — | 2.2 | — | mA |
| | | | XIN = 5 MHz (square wave) High-speed on-chip oscillator off Low-speed on-chip oscillator on = 125 kHz Divide-by-8 | — | 0.8 | — | mA |
| | | High-speed on-chip oscillator mode | XIN clock off High-speed on-chip oscillator on f _{OCO-F} = 5 MHz Low-speed on-chip oscillator on = 125 kHz No division | — | 2.5 | 10 | mA |
| | | | XIN clock off High-speed on-chip oscillator on f _{OCO-F} = 5 MHz Low-speed on-chip oscillator on = 125 kHz Divide-by-8 | — | 1.7 | — | mA |
| | | | XIN clock off High-speed on-chip oscillator on f _{OCO-F} = 4 MHz Low-speed on-chip oscillator on = 125 kHz Divide-by-16, MSTIIC = MSTTRD = MSTTRC = 1 | — | 1 | — | mA |
| | | Low-speed on-chip oscillator mode | XIN clock off High-speed on-chip oscillator off Low-speed on-chip oscillator on = 125 kHz Divide-by-8, FMR27 = 1, VCA20 = 0 | — | 90 | 300 | μA |
| | | Low-speed clock mode | XIN clock off High-speed on-chip oscillator off Low-speed on-chip oscillator off XCIN clock oscillator on = 32 kHz No division FMR27 = 1, VCA20 = 0 | — | 80 | 350 | μA |
| | | | XIN clock off High-speed on-chip oscillator off Low-speed on-chip oscillator off XCIN clock oscillator on = 32 kHz No division Program operation on RAM Flash memory off, FMSTP = 1, VCA20 = 0 | — | 40 | — | μA |
| | | | XIN clock off High-speed on-chip oscillator off Low-speed on-chip oscillator on = 125 kHz While a WAIT instruction is executed Peripheral clock operation VCA27 = VCA26 = VCA25 = 0, VCA20 = 1 | — | 15 | 90 | μA |
| | | Wait mode | XIN clock off High-speed on-chip oscillator off Low-speed on-chip oscillator on = 125 kHz While a WAIT instruction is executed Peripheral clock operation VCA27 = VCA26 = VCA25 = 0, VCA20 = 1 | — | 4 | 80 | μA |
| | | | XIN clock off High-speed on-chip oscillator off Low-speed on-chip oscillator off XCIN clock oscillator on = 32 kHz (peripheral clock off) While a WAIT instruction is executed VCA27 = VCA26 = VCA25 = 0, VCA20 = 1 | — | 3.5 | — | μA |
| | | | XIN clock off, T _{opr} = 25 °C High-speed on-chip oscillator off Low-speed on-chip oscillator off CM10 = 1 Peripheral clock off VCA27 = VCA26 = VCA25 = 0 | — | 2.0 | 5 | μA |
| | | Stop mode | XIN clock off, T _{opr} = 85 °C High-speed on-chip oscillator off Low-speed on-chip oscillator off CM10 = 1 Peripheral clock off VCA27 = VCA26 = VCA25 = 0 | — | 15 | — | μA |

Timing requirements (Unless Otherwise Specified: $V_{CC} = 2.2\text{ V}$, $V_{SS} = 0\text{ V}$, $T_{opr} = 25\text{ }^{\circ}\text{C}$)**Table 5.33 External Clock Input (XOUT, XCIN)**

| Symbol | Parameter | Standard | | Unit |
|----------------|-----------------------|----------|------|---------------|
| | | Min. | Max. | |
| $t_{c(XOUT)}$ | XOUT input cycle time | 200 | — | ns |
| $t_{WH(XOUT)}$ | XOUT input "H" width | 90 | — | ns |
| $t_{WL(XOUT)}$ | XOUT input "L" width | 90 | — | ns |
| $t_{c(XCIN)}$ | XCIN input cycle time | 14 | — | μs |
| $t_{WH(XCIN)}$ | XCIN input "H" width | 7 | — | μs |
| $t_{WL(XCIN)}$ | XCIN input "L" width | 7 | — | μs |

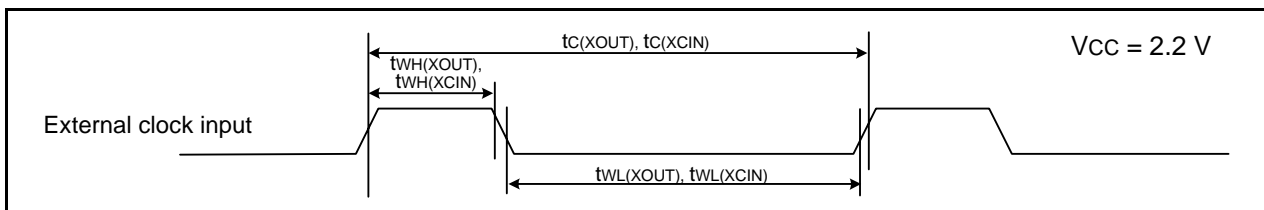
**Figure 5.18 External Clock Input Timing Diagram when $V_{CC} = 2.2\text{ V}$** **Table 5.34 TRAI0 Input**

| Symbol | Parameter | Standard | | Unit |
|-----------------|------------------------|----------|------|------|
| | | Min. | Max. | |
| $t_{c(TRAIO)}$ | TRAIO input cycle time | 500 | — | ns |
| $t_{WH(TRAIO)}$ | TRAIO input "H" width | 200 | — | ns |
| $t_{WL(TRAIO)}$ | TRAIO input "L" width | 200 | — | ns |

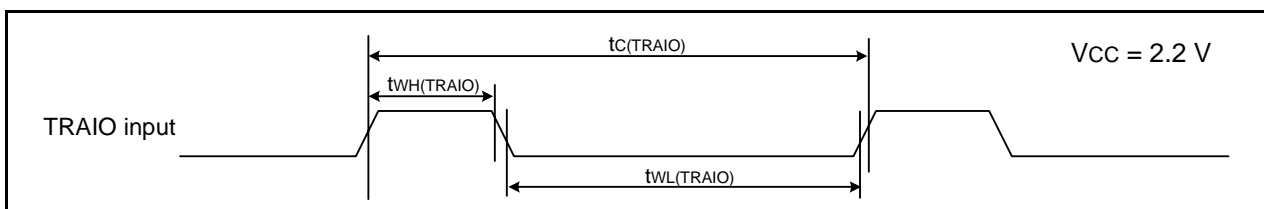
**Figure 5.19 TRAI0 Input Timing Diagram when $V_{CC} = 2.2\text{ V}$** **Table 5.35 TRFI Input**

| Symbol | Parameter | Standard | | Unit |
|----------------|-----------------------|----------|------|------|
| | | Min. | Max. | |
| $t_{c(TRFI)}$ | TRFI input cycle time | 2000 (1) | — | ns |
| $t_{WH(TRFI)}$ | TRFI input "H" width | 1000 (2) | — | ns |
| $t_{WL(TRFI)}$ | TRFI input "L" width | 1000 (2) | — | ns |

Notes:

1. When using timer RF input capture mode, adjust the cycle time to $(1/\text{timer RF count source frequency} \times 3)$ or above.
2. When using timer RF input capture mode, adjust the pulse width to $(1/\text{timer RF count source frequency} \times 1.5)$ or above.

**Figure 5.20 TRFI Input Timing Diagram when $V_{CC} = 2.2\text{ V}$**

Table 5.36 Serial Interface

| Symbol | Parameter | Standard | | Unit |
|---------------|------------------------|----------|------|------|
| | | Min. | Max. | |
| $t_{c(CK)}$ | CLKi input cycle time | 800 | — | ns |
| $t_{w(CKH)}$ | CLKi input "H" width | 400 | — | ns |
| $t_{w(CKL)}$ | CLKi input "L" width | 400 | — | ns |
| $t_{d(C-Q)}$ | TXDi output delay time | — | 200 | ns |
| $t_{h(C-Q)}$ | TXDi hold time | 0 | — | ns |
| $t_{su(D-C)}$ | RXDi input setup time | 150 | — | ns |
| $t_{h(C-D)}$ | RXDi input hold time | 90 | — | ns |

$i = 0$ to 2

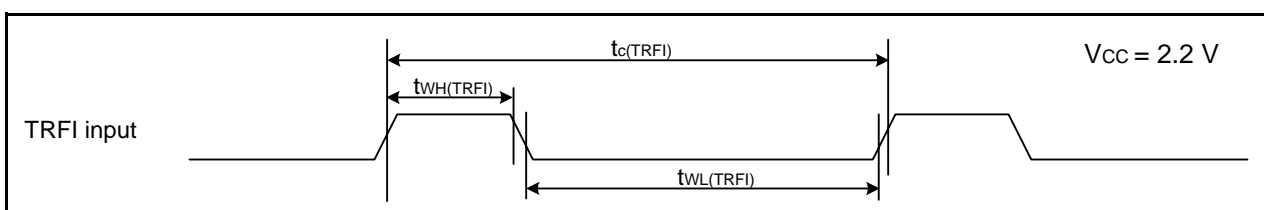
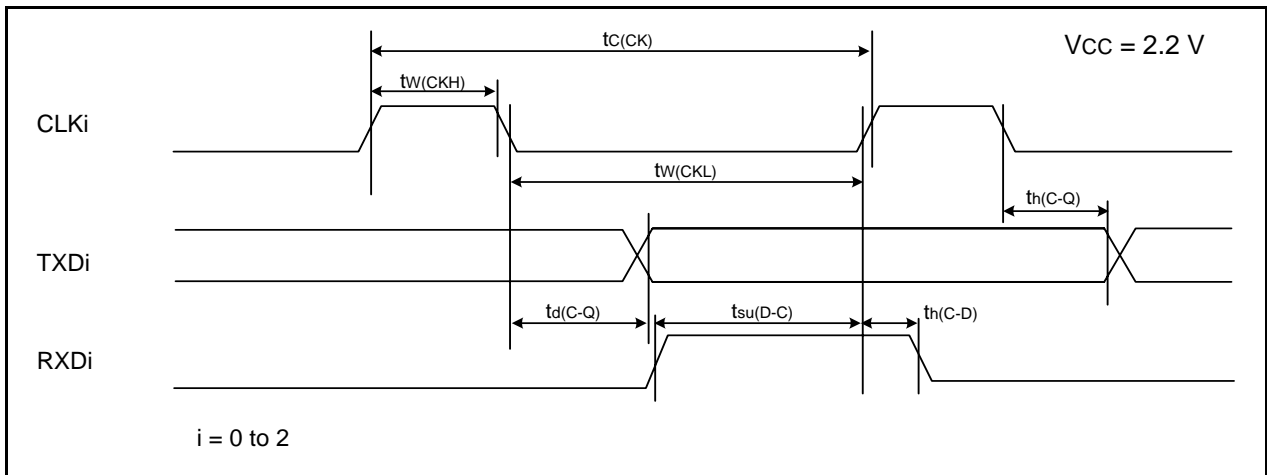

Figure 5.21 Serial Interface Timing Diagram when Vcc = 2.2 V

Table 5.37 External Interrupt \overline{INTi} ($i = 0$ to 4) Input, Key Input Interrupt \overline{Kli} ($i = 0$ to 3)

| Symbol | Parameter | Standard | | Unit |
|--------------|---|----------|------|------|
| | | Min. | Max. | |
| $t_{w(INH)}$ | \overline{INTi} input "H" width, \overline{Kli} input "H" width | 1000 (1) | — | ns |
| $t_{w(INL)}$ | \overline{INTi} input "L" width, \overline{Kli} input "L" width | 1000 (2) | — | ns |

Notes:

1. When selecting the digital filter by the \overline{INTi} input filter select bit, use an \overline{INTi} input HIGH width of either (1/digital filter clock frequency \times 3) or the minimum value of standard, whichever is greater.
2. When selecting the digital filter by the \overline{INTi} input filter select bit, use an \overline{INTi} input LOW width of either (1/digital filter clock frequency \times 3) or the minimum value of standard, whichever is greater.

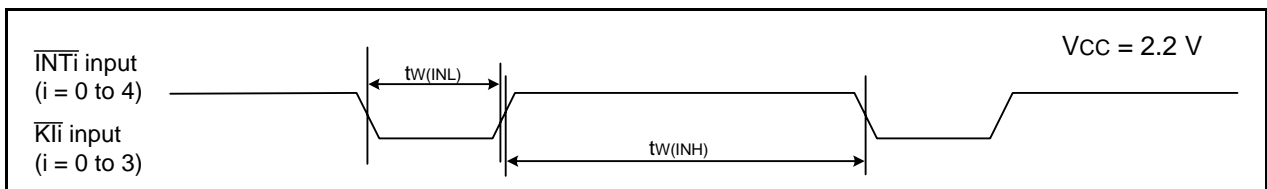
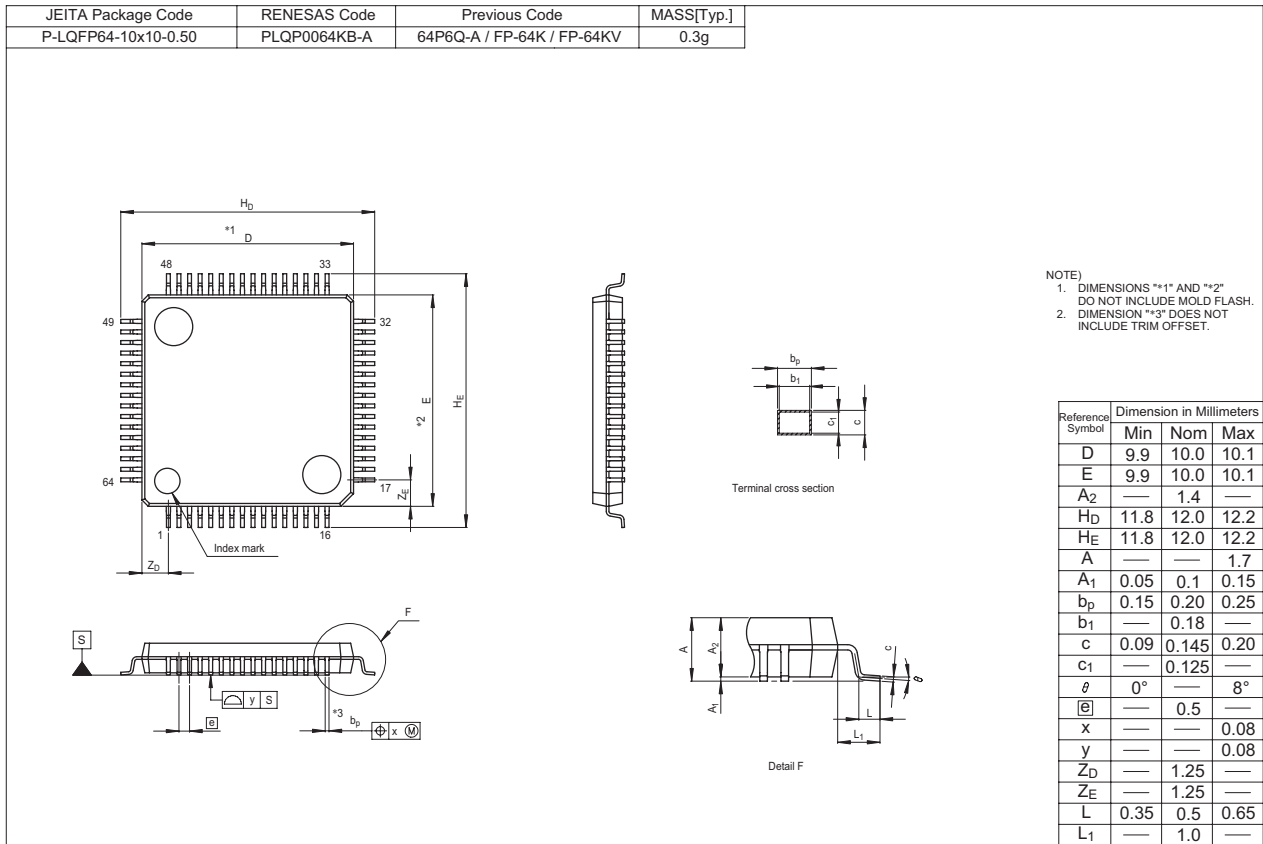
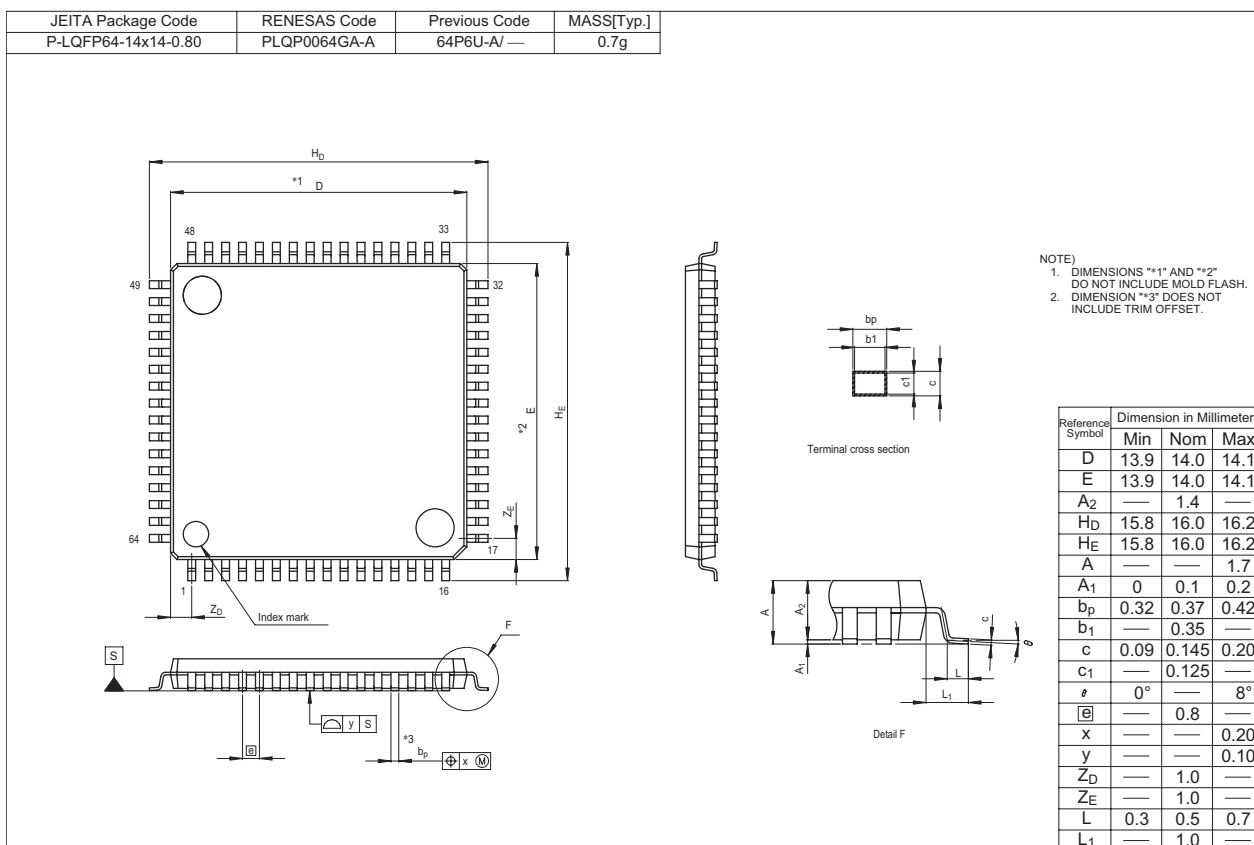

Figure 5.22 Input Timing Diagram for External Interrupt \overline{INTi} and Key Input Interrupt \overline{Kli} when Vcc = 2.2 V

Package Dimensions

Diagrams showing the latest package dimensions and mounting information are available in the “Packages” section of the Renesas Electronics website.





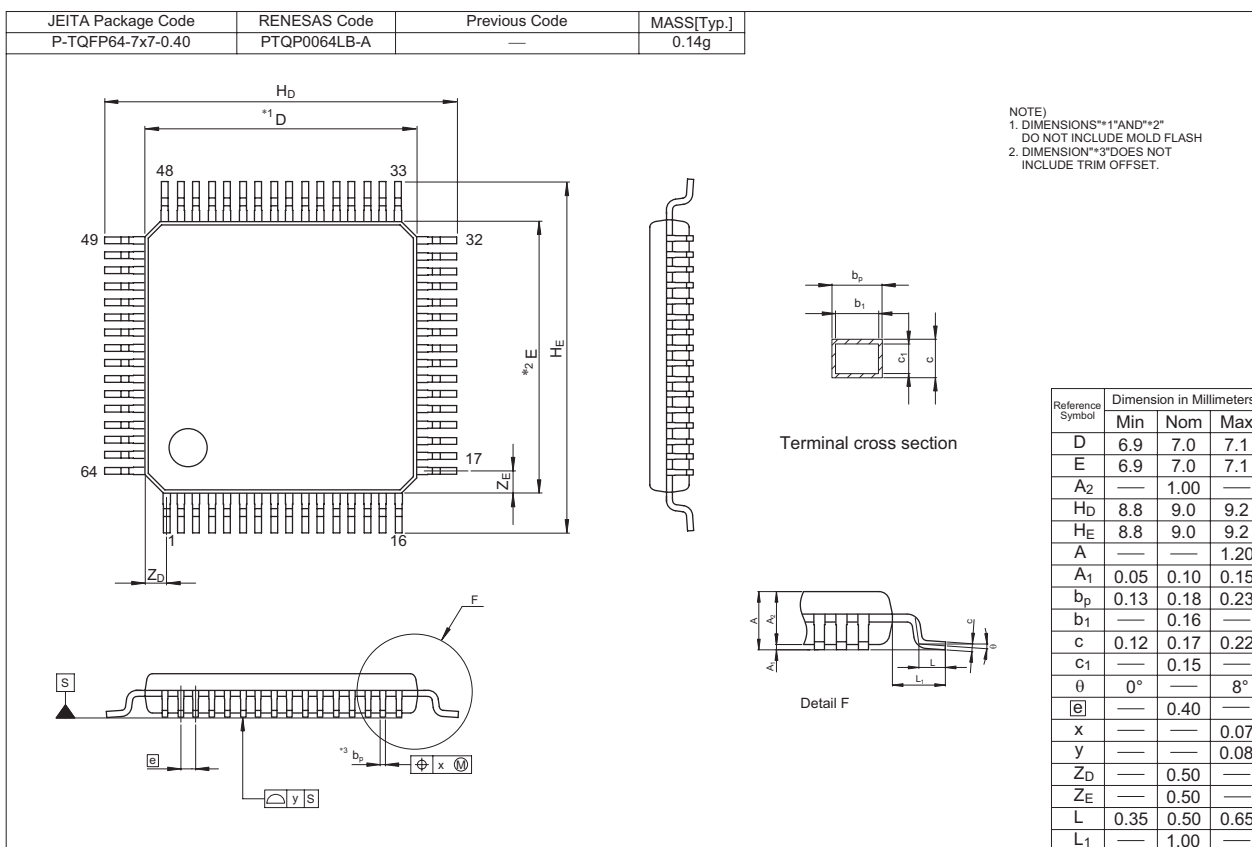

| | |
|------------------|-------------------------|
| REVISION HISTORY | R8C/36C Group Datasheet |
|------------------|-------------------------|

| Rev. | Date | Description | |
|------|--------------|---|---|
| | | Page | Summary |
| 0.01 | Oct 30, 2009 | — | First Edition issued |
| 1.00 | Nov 02, 2010 | All pages 4 28 to 54 | “Preliminary”, “Under development” deleted Table 1.3 revised “5. Electrical Characteristics” added |
| 1.10 | Nov 02, 2010 | — 3 4 and 5 6 8 17 33 47 51 55 59 | TN-R8C-A015A/E reflected Table 1.2 “Timer RG” and “Package” revised Tables 1.3 and 1.4 revised Figure 1.1 revised Figure 1.3 “PTQP0064LB-A” added Figure 3.1 “Part Number” revised Table 5.3 “tCONV”, “tSAMP” revised Table 5.21 revised Table 5.28 revised Table 5.35 revised Package (PTQP0064LB-A) added |

| |
|---|
| All trademarks and registered trademarks are the property of their respective owners. |
|---|

General Precautions in the Handling of MPU/MCU Products

The following usage notes are applicable to all MPU/MCU products from Renesas. For detailed usage notes on the products covered by this manual, refer to the relevant sections of the manual. If the descriptions under General Precautions in the Handling of MPU/MCU Products and in the body of the manual differ from each other, the description in the body of the manual takes precedence.

1. Handling of Unused Pins

Handle unused pins in accord with the directions given under Handling of Unused Pins in the manual.

- The input pins of CMOS products are generally in the high-impedance state. In operation with an unused pin in the open-circuit state, extra electromagnetic noise is induced in the vicinity of LSI, an associated shoot-through current flows internally, and malfunctions occur due to the false recognition of the pin state as an input signal become possible. Unused pins should be handled as described under Handling of Unused Pins in the manual.

2. Processing at Power-on

The state of the product is undefined at the moment when power is supplied.

- The states of internal circuits in the LSI are indeterminate and the states of register settings and pins are undefined at the moment when power is supplied.

In a finished product where the reset signal is applied to the external reset pin, the states of pins are not guaranteed from the moment when power is supplied until the reset process is completed.

In a similar way, the states of pins in a product that is reset by an on-chip power-on reset function are not guaranteed from the moment when power is supplied until the power reaches the level at which resetting has been specified.

3. Prohibition of Access to Reserved Addresses

Access to reserved addresses is prohibited.

- The reserved addresses are provided for the possible future expansion of functions. Do not access these addresses; the correct operation of LSI is not guaranteed if they are accessed.

4. Clock Signals

After applying a reset, only release the reset line after the operating clock signal has become stable. When switching the clock signal during program execution, wait until the target clock signal has stabilized.

- When the clock signal is generated with an external resonator (or from an external oscillator) during a reset, ensure that the reset line is only released after full stabilization of the clock signal. Moreover, when switching to a clock signal produced with an external resonator (or by an external oscillator) while program execution is in progress, wait until the target clock signal is stable.

5. Differences between Products

Before changing from one product to another, i.e. to one with a different part number, confirm that the change will not lead to problems.

- The characteristics of MPU/MCU in the same group but having different part numbers may differ because of the differences in internal memory capacity and layout pattern. When changing to products of different part numbers, implement a system-evaluation test for each of the products.

Notice

- All information included in this document is current as of the date this document is issued. Such information, however, is subject to change without any prior notice. Before purchasing or using any Renesas Electronics products listed herein, please confirm the latest product information with a Renesas Electronics sales office. Also, please pay regular and careful attention to additional and different information to be disclosed by Renesas Electronics such as that disclosed through our website.
- Renesas Electronics does not assume any liability for infringement of patents, copyrights, or other intellectual property rights of third parties by or arising from the use of Renesas Electronics products or technical information described in this document. No license, express, implied or otherwise, is granted hereby under any patents, copyrights or other intellectual property rights of Renesas Electronics or others.
- You should not alter, modify, copy, or otherwise misappropriate any Renesas Electronics product, whether in whole or in part.
- Descriptions of circuits, software and other related information in this document are provided only to illustrate the operation of semiconductor products and application examples. You are fully responsible for the incorporation of these circuits, software, and information in the design of your equipment. Renesas Electronics assumes no responsibility for any losses incurred by you or third parties arising from the use of these circuits, software, or information.
- When exporting the products or technology described in this document, you should comply with the applicable export control laws and regulations and follow the procedures required by such laws and regulations. You should not use Renesas Electronics products or the technology described in this document for any purpose relating to military applications or use by the military, including but not limited to the development of weapons of mass destruction. Renesas Electronics products and technology may not be used for or incorporated into any products or systems whose manufacture, use, or sale is prohibited under any applicable domestic or foreign laws or regulations.
- Renesas Electronics has used reasonable care in preparing the information included in this document, but Renesas Electronics does not warrant that such information is error free. Renesas Electronics assumes no liability whatsoever for any damages incurred by you resulting from errors in or omissions from the information included herein.
- Renesas Electronics products are classified according to the following three quality grades: "Standard", "High Quality", and "Specific". The recommended applications for each Renesas Electronics product depends on the product's quality grade, as indicated below. You must check the quality grade of each Renesas Electronics product before using it in a particular application. You may not use any Renesas Electronics product for any application categorized as "Specific" without the prior written consent of Renesas Electronics. Further, you may not use any Renesas Electronics product for any application for which it is not intended without the prior written consent of Renesas Electronics. Renesas Electronics shall not be in any way liable for any damages or losses incurred by you or third parties arising from the use of any Renesas Electronics product for an application categorized as "Specific" or for which the product is not intended where you have failed to obtain the prior written consent of Renesas Electronics. The quality grade of each Renesas Electronics product is "Standard" unless otherwise expressly specified in a Renesas Electronics data sheets or data books, etc.
"Standard": Computers; office equipment; communications equipment; test and measurement equipment; audio and visual equipment; home electronic appliances; machine tools; personal electronic equipment; and industrial robots.
"High Quality": Transportation equipment (automobiles, trains, ships, etc.); traffic control systems; anti-disaster systems; anti-crime systems; safety equipment; and medical equipment not specifically designed for life support.
"Specific": Aircraft; aerospace equipment; submersible repeaters; nuclear reactor control systems; medical equipment or systems for life support (e.g. artificial life support devices or systems), surgical implantations, or healthcare intervention (e.g. excision, etc.), and any other applications or purposes that pose a direct threat to human life.
- You should use the Renesas Electronics products described in this document within the range specified by Renesas Electronics, especially with respect to the maximum rating, operating supply voltage range, movement power voltage range, heat radiation characteristics, installation and other product characteristics. Renesas Electronics shall have no liability for malfunctions or damages arising out of the use of Renesas Electronics products beyond such specified ranges.
- Although Renesas Electronics endeavors to improve the quality and reliability of its products, semiconductor products have specific characteristics such as the occurrence of failure at a certain rate and malfunctions under certain use conditions. Further, Renesas Electronics products are not subject to radiation resistance design. Please be sure to implement safety measures to guard them against the possibility of physical injury, and injury or damage caused by fire in the event of the failure of a Renesas Electronics product, such as safety design for hardware and software including but not limited to redundancy, fire control and malfunction prevention, appropriate treatment for aging degradation or any other appropriate measures. Because the evaluation of microcomputer software alone is very difficult, please evaluate the safety of the final products or system manufactured by you.
- Please contact a Renesas Electronics sales office for details as to environmental matters such as the environmental compatibility of each Renesas Electronics product. Please use Renesas Electronics products in compliance with all applicable laws and regulations that regulate the inclusion or use of controlled substances, including without limitation, the EU RoHS Directive. Renesas Electronics assumes no liability for damages or losses occurring as a result of your noncompliance with applicable laws and regulations.
- This document may not be reproduced or duplicated, in any form, in whole or in part, without prior written consent of Renesas Electronics.
- Please contact a Renesas Electronics sales office if you have any questions regarding the information contained in this document or Renesas Electronics products, or if you have any other inquiries.
(Note 1) "Renesas Electronics" as used in this document means Renesas Electronics Corporation and also includes its majority-owned subsidiaries.
(Note 2) "Renesas Electronics product(s)" means any product developed or manufactured by or for Renesas Electronics.



SALES OFFICES

Renesas Electronics Corporation

<http://www.renesas.com>

Refer to "<http://www.renesas.com/>" for the latest and detailed information.

Renesas Electronics America Inc.
2880 Scott Boulevard Santa Clara, CA 95050-2554, U.S.A.
Tel: +1-408-588-6000, Fax: +1-408-588-6130

Renesas Electronics Canada Limited
1101 Nicholson Road, Newmarket, Ontario L3Y 9C3, Canada
Tel: +1-905-898-5441, Fax: +1-905-898-3220

Renesas Electronics Europe Limited
Dukes Meadow, Millboard Road, Bourne End, Buckinghamshire, SL8 5FH, U.K
Tel: +44-1628-585-100, Fax: +44-1628-585-900

Renesas Electronics Europe GmbH
Arcadiastrasse 10, 40472 Düsseldorf, Germany
Tel: +49-211-65030, Fax: +49-211-6503-1327

Renesas Electronics (China) Co., Ltd.
7th Floor, Quantum Plaza, No.27 ZhichunLu Haidian District, Beijing 100083, P.R.China
Tel: +86-10-8235-1155, Fax: +86-10-8235-7679

Renesas Electronics (Shanghai) Co., Ltd.
Unit 204, 205, AZIA Center, No.1233 Lujiazui Ring Rd., Pudong District, Shanghai 200120, China
Tel: +86-21-5877-1818, Fax: +86-21-6887-7858 / -7898

Renesas Electronics Hong Kong Limited
Unit 1601-1613, 16/F., Tower 2, Grand Century Place, 193 Prince Edward Road West, Mongkok, Kowloon, Hong Kong
Tel: +852-2886-9318, Fax: +852-2886-9022/9044

Renesas Electronics Taiwan Co., Ltd.
7F, No. 363 Fu Shing North Road Taipei, Taiwan
Tel: +886-2-8175-9600, Fax: +886-2-8175-9670

Renesas Electronics Singapore Pte. Ltd.
1 HarbourFront Avenue, #06-10, Keppel Bay Tower, Singapore 098632
Tel: +65-6213-0200, Fax: +65-6278-8001

Renesas Electronics Malaysia Sdn.Bhd.
Unit 906, Block B, Menara Amcorp, Amcorp Trade Centre, No. 18, Jln Persiaran Barat, 46050 Petaling Jaya, Selangor Darul Ehsan, Malaysia
Tel: +60-3-7955-9390, Fax: +60-3-7955-9510





Renesas Electronics Korea Co., Ltd.
11F., Samik Laviel'or Bldg., 720-2 Yeoksam-Dong, Kangnam-Ku, Seoul 135-080, Korea
Tel: +82-2-558-3737, Fax: +82-2-558-5141

Looking for pricing, stock, or lifecycle information?

Click below to explore more details on WIN SOURCE:

-  [View R5F21368CNFP#50 on WIN SOURCE](#)
-  [Renesas Electronics America Information](#)

Optimize Your Supply Chain with WIN SOURCE Solutions

-  Global Sourcing Solution
-  Obsolete Management
-  Cost Control Management
-  Shortage Management
-  Alternative Solution
-  Excess Inventory Management