



THE DATASHEET OF FML-12S



1. Scope

The present specifications shall apply to an FML-12S.

2. Outline

Type	Silicon Diode
Structure	Resin Molded
Applications	High Frequency Rectification

3. Flammability

UL94V-0(Equivalent)

4. Absolute maximum ratings

No.	Item	Symbol	Unit	Rating	Conditions
1	Transient Peak Reverse Voltage	V_{RSM}	V	200	
2	Peak Reverse Voltage	V_{RM}	V	200	
3	Average Forward Current	$I_{F(AV)}$	A	5.0	Refer to Derating of 7
4	Peak Surge Forward Current	I_{FSM}	A	35	10msec. Half sinewave, one shot
5	I^2t Limiting Value	I^2t	A^2s	6.1	$1msec \leq t \leq 10msec$
6	Junction Temperature	T_j	$^{\circ}C$	-40~+150	
7	Storage Temperature	T_{stg}	$^{\circ}C$	-40~+150	

No.1,2,4&5 show ratings per one chip.

5. Electrical characteristics ($T_a=25^{\circ}C$, unless otherwise specified)

No.	Item	Symbol	Unit	Value	Conditions
1	Forward Voltage Drop	V_F	V	0.98 max.	$I_F=2.5A$
2	Reverse Leakage Current	I_R	μA	50 max.	$V_R=V_{RM}$
3	Reverse Leakage Current Under High Temperature	$H \cdot I_R$	μA	100 max.	$V_R=V_{RM}, T_j=150^{\circ}C$
4	Reverse Recovery Time	trr1	ns	40 max.	$I_F=I_{RP}=100mA$ 90% Recovery point, $T_j=25^{\circ}C$
		trr2	ns	30 max.	$I_F=100mA, I_{RP}=200mA$ 75% Recovery point, $T_j=25^{\circ}C$
4	Thermal Resistance	$R_{th(j-c)}$	$^{\circ}C/W$	4.0 max.	Between Junction and case

No.1,2,3&4 show characteristics per one chip.

6. Characteristics

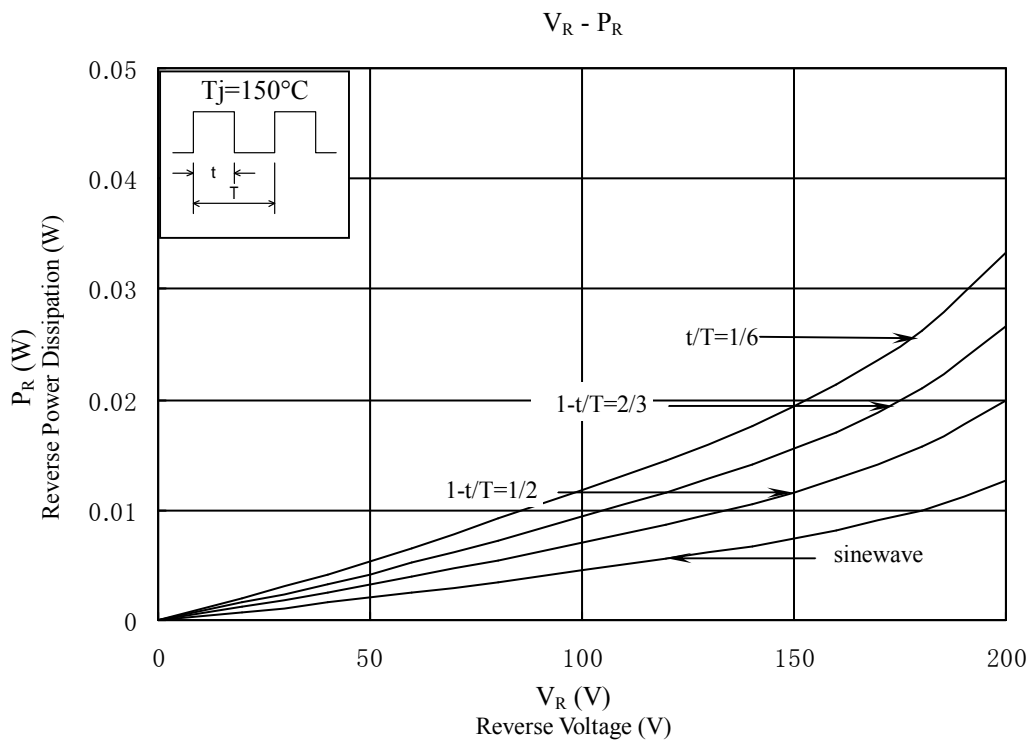
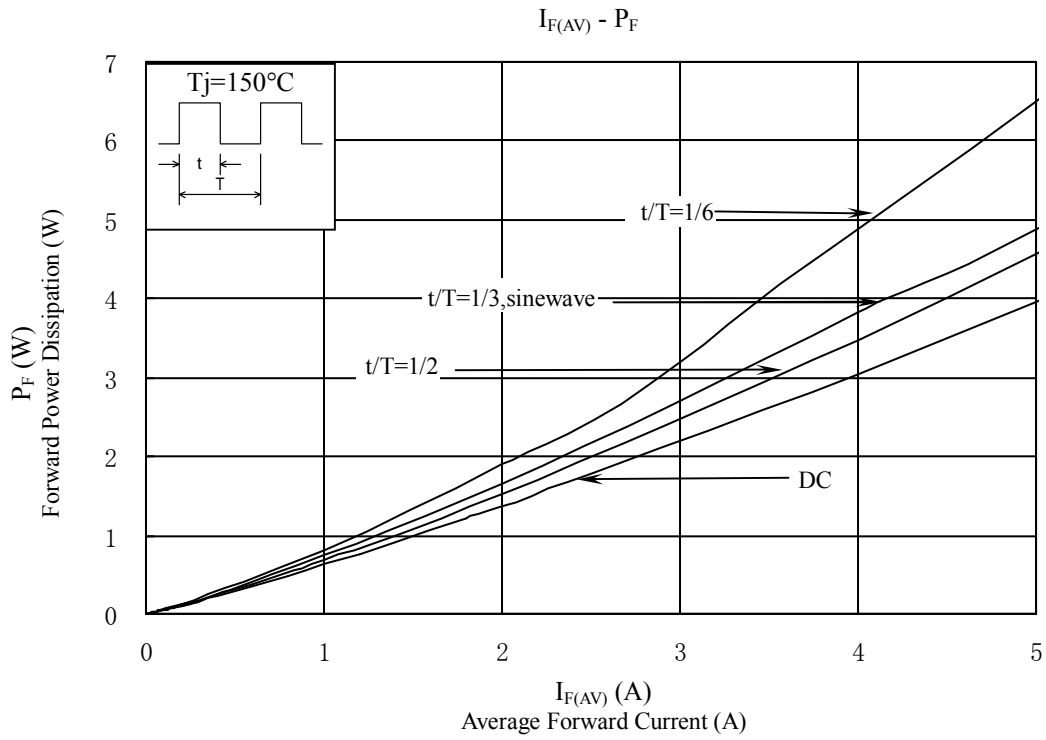

7. Derating

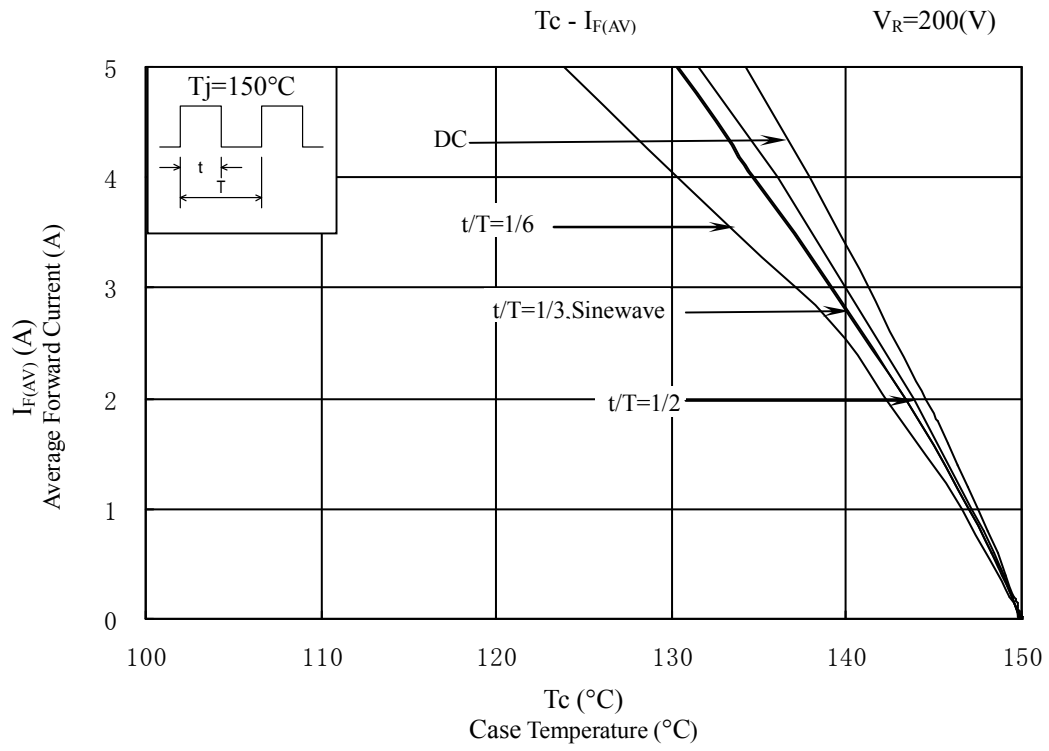

8. Package information

8-1 Package type, physical dimensions and material

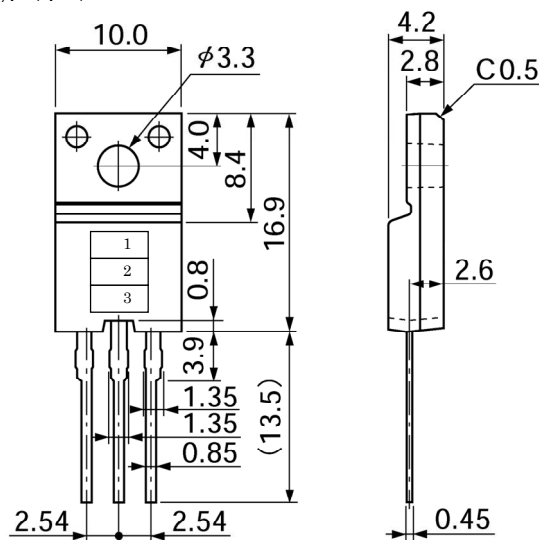

: 根元寸法
: root dimension

指示なき公差 ±0.2
tolerance ±0.2

単位 : mm
Dimensions in mm

8-2 Appearance



The body shall be clean and shall not bear any stain, rust or flaw.

8-3 Marking







Type Name	Marking		
	*1 Type Name	*2 Polarity	*3 Lot number
FML-12S	FML12S		1st letter: Last digit of year 2nd letter: Month From 1 to 9 for Jan. to Sep., O for Oct., N for Nov., D for Dec. 3rd & 4th letter: Day ex. 4O13 (Oct.13, 2004)

Looking for pricing, stock, or lifecycle information?

Click below to explore more details on WIN SOURCE:

-  [View FML-12S on WIN SOURCE](#)
-  [Sanken Information](#)

Optimize Your Supply Chain with WIN SOURCE Solutions

-  Global Sourcing Solution
-  Obsolete Management
-  Cost Control Management
-  Shortage Management
-  Alternative Solution
-  Excess Inventory Management