



**THE DATASHEET OF  
ADP198ACBZ-11-R7**



## FEATURES

- Low  $R_{DS(on)}$  of 50 m $\Omega$  @ 3.3 V (WLCSP only)
- Low input voltage range: 1.65 V to 6.5 V
- 1 A continuous operating current
- Built-in level shift for control logic that can be operated by 1.2 V logic
- Low 2.5  $\mu$ A quiescent current @  $V_{IN} = 2.8$  V
- Low 1.1  $\mu$ A shutdown current @  $V_{IN} = 2.8$  V
- Reverse current blocking
- Programmable start-up time
- Ultrasmall 1 mm  $\times$  1 mm, 4-ball, 0.5 mm pitch (WLCSP)
- Tiny 8-lead lead frame chip scale package (LFCSP)
  - 2.0 mm  $\times$  2.0 mm  $\times$  0.55 mm, 0.5 mm pitch

## APPLICATIONS

- Mobile phones
- Digital cameras and audio devices
- Portable and battery-powered equipment

## GENERAL DESCRIPTION

The ADP198 is a high-side load switch designed for operation between 1.65 V and 6.5 V that is protected against reverse current flow from output to input. A load switch provides power domain isolation, thereby helping to keep subsystems isolated and powered independently and enabling reduced power consumption. The ADP198 contains a low on-resistance P-channel MOSFET that supports more than 1 A of continuous load current. The low 2.5  $\mu$ A quiescent current and ultralow shutdown current make the ADP198 ideal for battery-operated portable

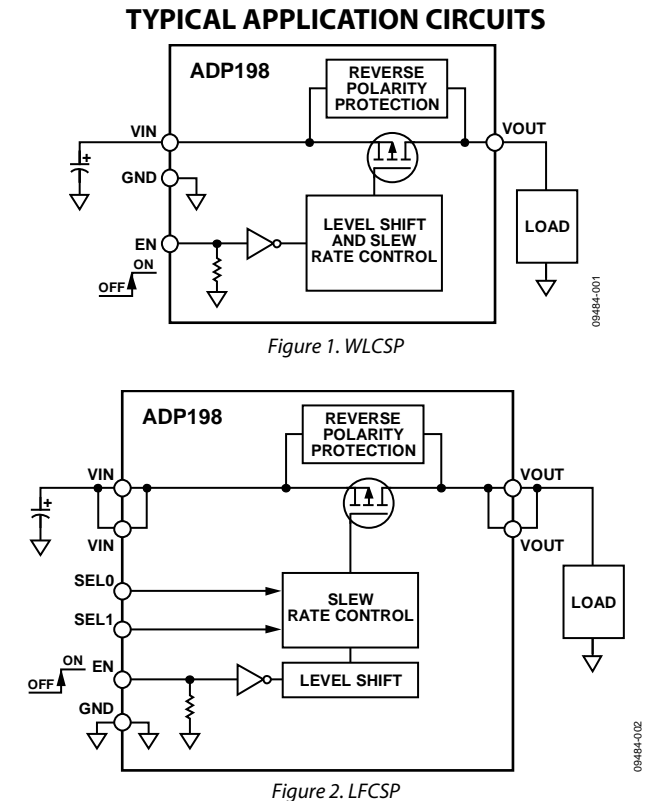

equipment. The built-in level shifter for enable logic makes the ADP198 compatible with modern processors and general-purpose input/output (GPIO) controllers. The LFCSP version also allows the user to program the start-up time to control the inrush current at turn on.

The ADP198 is available in an ultrasmall 1 mm  $\times$  1 mm, 4-ball, 0.5 mm pitch WLCSP. An 8-lead, 2 mm  $\times$  2 mm  $\times$  0.55 mm, 0.5 mm pitch LFCSP is also available.

## TABLE OF CONTENTS

Features .....	1	Typical Performance Characteristics .....	8
Applications.....	1	Theory of Operation .....	11
Typical Application Circuits.....	1	Applications Information .....	12
General Description .....	1	Ground Current.....	12
Revision History .....	2	Enable Feature .....	13
Specifications.....	3	Timing.....	14
Absolute Maximum Ratings .....	5	Diode OR'ing Applications .....	15
Thermal Data .....	5	Packaging and Ordering Information .....	16
Thermal Resistance .....	5	Outline Dimensions .....	16
ESD Caution.....	5	Ordering Guide .....	16
Pin Configurations and Function Descriptions .....	6		

## REVISION HISTORY

### 8/13—Rev. F to Rev. G

Changed Input Voltage Range Condition from $T_J = -40^{\circ}\text{C}$ to $+85^{\circ}\text{C}$ to $T_J = -40^{\circ}\text{C}$ to $+125^{\circ}\text{C}$ ; Table 1 .....	3
Added Continuous Drain Input, $T_A = 125^{\circ}\text{C}$ of $\pm 600$ mA.....	5

### 6/13—Rev. E to Rev. F

Changes to Table 1 .....	3
Updated Outline Dimensions .....	16

### 7/12—Rev. D to Rev. E

Changes to Table 1 .....	3
Changes to Figure 3.....	4
Changes to Timing Section and Table 6 .....	14
Changes to Ordering Guide .....	16

### 6/12—Rev. C to Rev. D

Changes to Table Headings in Table 6 .....	14
--	----

Added Text to Diode OR'ing Applications Section .....	15
Updated Outline Dimensions.....	16

### 4/12—Rev. B to Rev. C

Changes to VOUT Time Parameters.....	3
--------------------------------------	---

### 11/11—Rev. A to Rev. B

Changes to WLCSP Turn-On Delay Time Parameter.....	3
Changes to Ordering Guide .....	16

### 10/11—Rev. 0 to Rev. A

Change to Features Section .....	1
Changes to Table 1, Specifications Section .....	3
Change to Ground Current Section.....	12
Changes to Enable Feature Section .....	13
Updated Outline Dimensions .....	16

### 10/11—Revision 0: Initial Version

## SPECIFICATIONS

$V_{IN} = 2.8\text{ V}$ ,  $EN = V_{IN}$ ,  $I_{OUT} = 200\text{ mA}$ ,  $T_A = 25^\circ\text{C}$ , unless otherwise noted.  $T_J = -40^\circ\text{C}$  to  $+85^\circ\text{C}$  for minimum/maximum specifications, unless otherwise noted.

Table 1.

Parameter	Symbol	Test Conditions/Comments	Min	Typ	Max	Unit
INPUT VOLTAGE RANGE	$V_{IN}$	$T_J = -40^\circ\text{C}$ to $+125^\circ\text{C}$	1.65		6.5	V
EN INPUT						
Threshold						
High	$V_{IH}$	$V_{IN} \leq 5\text{ V}$ $5\text{ V} < V_{IN}$	1.2			V
Low	$V_{IL}$	$1.65\text{ V} \leq V_{IN} \leq 6.5\text{ V}$ $1.65\text{ V} \leq V_{IN} \leq 6.5\text{ V}$ , $T_J = -40^\circ\text{C}$ to $+125^\circ\text{C}$	1.3		0.43	V
Pull-Down Current	$I_{EN}$			500	0.37	nA
REVERSE BLOCKING						
$V_{OUT}$ Current		$V_{EN} = 0$ , $V_{IN} = 0$ , $V_{OUT} = 6.5\text{ V}$		7	13	$\mu\text{A}$
Hysteresis		$ V_{IN} - V_{OUT} $		75		mV
CURRENT						
Quiescent Current	$I_Q$	$I_{OUT} = 0\text{ mA}$ , includes EN pull-down current $V_{IN} = V_{OUT} = 2.8\text{ V}$ $V_{IN} = V_{OUT} = 6.5\text{ V}$		2.5		$\mu\text{A}$
Off State Current	$I_{OFF}$	EN = GND EN = GND, $V_{OUT} = 0\text{ V}$		1.1	2	$\mu\text{A}$
VIN to VOUT RESISTANCE	$R_{DS(ON)}$					
WLCSP		$V_{IN} = 5\text{ V}$ , $I_{LOAD} = 200\text{ mA}$ , $V_{EN} = 1.5\text{ V}$ $V_{IN} = 3.3\text{ V}$ , $I_{LOAD} = 200\text{ mA}$ , $V_{EN} = 1.5\text{ V}$ $V_{IN} = 3.3\text{ V}$ , $I_{LOAD} = 200\text{ mA}$ , $V_{EN} = 1.5\text{ V}$ , $T_J = -40^\circ\text{C}$ to $+125^\circ\text{C}$ $V_{IN} = 2.8\text{ V}$ , $I_{LOAD} = 200\text{ mA}$ , $V_{EN} = 1.5\text{ V}$ $V_{IN} = 1.8\text{ V}$ , $I_{LOAD} = 200\text{ mA}$ , $V_{EN} = 1.5\text{ V}$ $V_{IN} = 1.65\text{ V}$ , $I_{LOAD} = 200\text{ mA}$ , $V_{EN} = 1.5\text{ V}$		40		m $\Omega$
LFCSP		$V_{IN} = 5\text{ V}$ , $I_{LOAD} = 200\text{ mA}$ , $V_{EN} = 1.5\text{ V}$ $V_{IN} = 5\text{ V}$ , $I_{LOAD} = 200\text{ mA}$ , $V_{EN} = 1.5\text{ V}$ , $T_J = -40^\circ\text{C}$ to $+125^\circ\text{C}$ $V_{IN} = 3.3\text{ V}$ , $I_{LOAD} = 200\text{ mA}$ , $V_{EN} = 1.5\text{ V}$ $V_{IN} = 2.8\text{ V}$ , $I_{LOAD} = 200\text{ mA}$ , $V_{EN} = 1.5\text{ V}$ $V_{IN} = 1.8\text{ V}$ , $I_{LOAD} = 200\text{ mA}$ , $V_{EN} = 1.5\text{ V}$ $V_{IN} = 1.65\text{ V}$ , $I_{LOAD} = 200\text{ mA}$ , $V_{EN} = 1.5\text{ V}$		75	120	m $\Omega$
VOUT TIME						
WLCSP						
Turn-On Delay Time	$t_{ON\_DLY}$	$V_{IN} = 3.6\text{ V}$ , $I_{LOAD} = 200\text{ mA}$ , $V_{EN} = 1.5\text{ V}$ , $C_{LOAD} = 1\text{ }\mu\text{F}$ ; ADP198ACBZ-R7 $V_{IN} = 3.6\text{ V}$ , $I_{LOAD} = 200\text{ mA}$ , $V_{EN} = 1.5\text{ V}$ , $C_{LOAD} = 1\text{ }\mu\text{F}$ ; ADP198ACBZ-11-R7		10		$\mu\text{s}$
LFCSP						
Turn-On Delay Time	$t_{ON\_DLY}$	$V_{IN} = 3.6\text{ V}$ , $I_{LOAD} = 200\text{ mA}$ , $V_{EN} = 1.5\text{ V}$ , $C_{LOAD} = 1\text{ }\mu\text{F}$ ; SEL0 = L, SEL1 = L $V_{IN} = 3.6\text{ V}$ , $I_{LOAD} = 200\text{ mA}$ , $V_{EN} = 1.5\text{ V}$ , $C_{LOAD} = 1\text{ }\mu\text{F}$ ; SEL0 = H, SEL1 = L $V_{IN} = 3.6\text{ V}$ , $I_{LOAD} = 200\text{ mA}$ , $V_{EN} = 1.5\text{ V}$ , $C_{LOAD} = 1\text{ }\mu\text{F}$ ; SEL0 = L, SEL1 = H $V_{IN} = 3.6\text{ V}$ , $I_{LOAD} = 200\text{ mA}$ , $V_{EN} = 1.5\text{ V}$ , $C_{LOAD} = 1\text{ }\mu\text{F}$ ; SEL0 = H, SEL1 = H		10		$\mu\text{s}$
WLCSP						
Turn-On Rise Time	$t_{RISE}$	$V_{IN} = 3.6\text{ V}$ , $I_{LOAD} = 200\text{ mA}$ , $V_{EN} = 1.5\text{ V}$ , $C_{LOAD} = 1\text{ }\mu\text{F}$ ; ADP198ACBZ-R7 $V_{IN} = 3.6\text{ V}$ , $I_{LOAD} = 200\text{ mA}$ , $V_{EN} = 1.5\text{ V}$ , $C_{LOAD} = 1\text{ }\mu\text{F}$ ; ADP198ACBZ-11-R7		12		$\mu\text{s}$
LFCSP						
Turn-On Rise Time	$t_{RISE}$	$V_{IN} = 3.6\text{ V}$ , $I_{LOAD} = 200\text{ mA}$ , $V_{EN} = 1.5\text{ V}$ , $C_{LOAD} = 1\text{ }\mu\text{F}$ ; SEL0 = L, SEL1 = L $V_{IN} = 3.6\text{ V}$ , $I_{LOAD} = 200\text{ mA}$ , $V_{EN} = 1.5\text{ V}$ , $C_{LOAD} = 1\text{ }\mu\text{F}$ ; SEL0 = H, SEL1 = L $V_{IN} = 3.6\text{ V}$ , $I_{LOAD} = 200\text{ mA}$ , $V_{EN} = 1.5\text{ V}$ , $C_{LOAD} = 1\text{ }\mu\text{F}$ ; SEL0 = L, SEL1 = H $V_{IN} = 3.6\text{ V}$ , $I_{LOAD} = 200\text{ mA}$ , $V_{EN} = 1.5\text{ V}$ , $C_{LOAD} = 1\text{ }\mu\text{F}$ ; SEL0 = H, SEL1 = H		12		$\mu\text{s}$

Timing Diagram

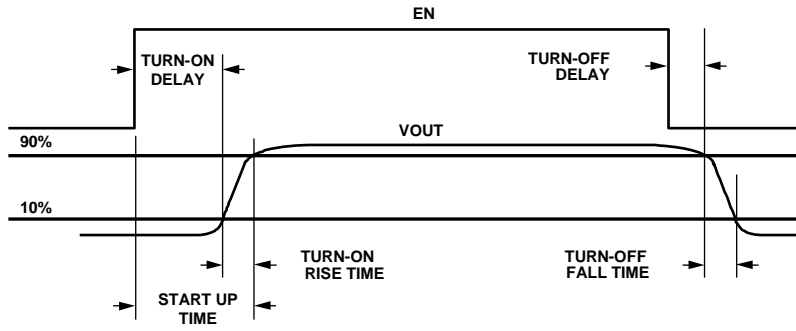

Figure 3. Timing Diagram

09484-1033

## ABSOLUTE MAXIMUM RATINGS

Table 2.

Parameter	Rating
VIN to GND Pins	−0.3 V to +7 V
VOU to GND Pins	−0.3 V to +7 V
EN to GND Pins	−0.3 V to +7 V
Continuous Drain Current	
T <sub>A</sub> = 25°C	±1000 mA
T <sub>A</sub> = 85°C	±1000 mA
T <sub>A</sub> = 125°C	±600mA
Storage Temperature Range	−65°C to +150°C
Operating Junction Temperature Range	−40°C to +125°C
Soldering Conditions	JEDEC J-STD-020

Stresses above those listed under Absolute Maximum Ratings may cause permanent damage to the device. This is a stress rating only; functional operation of the device at these or any other conditions above those indicated in the operational section of this specification is not implied. Exposure to absolute maximum rating conditions for extended periods may affect device reliability.

## THERMAL DATA

Absolute maximum ratings apply individually only, not in combination. The ADP198 can be damaged if the junction temperature limits are exceeded. Monitoring ambient temperature does not guarantee that T<sub>J</sub> is within the specified temperature limits. In applications with high power dissipation and poor thermal resistance, the maximum ambient temperature may need to be derated.

In applications with moderate power dissipation and low printed circuit board (PCB) thermal resistance, the maximum ambient temperature can exceed the maximum limit as long as the junction temperature is within specification limits. The junction temperature (T<sub>J</sub>) of the device is dependent on the ambient temperature (T<sub>A</sub>), the power dissipation of the device (P<sub>D</sub>), and the junction-to-ambient thermal resistance of the package (θ<sub>JA</sub>).

Maximum junction temperature (T<sub>J</sub>) is calculated from the ambient temperature (T<sub>A</sub>) and power dissipation (P<sub>D</sub>) using the formula

$$T_J = T_A + (P_D \times \theta_{JA})$$

The junction-to-ambient thermal resistance (θ<sub>JA</sub>) of the package is based on modeling and calculation using a 4-layer board. The junction-to-ambient thermal resistance is highly dependent on the application and board layout. In applications where high maximum power dissipation exists, close attention to thermal board design is required. The value of θ<sub>JA</sub> may vary, depending on PCB material, layout, and environmental conditions. The specified values of θ<sub>JA</sub> are based on a 4-layer, 4 inch × 3 inch PCB. Refer to JESD 51-7 and JESD 51-9 for detailed information regarding board construction. For additional information, see the [AN-617 Application Note, MicroCSP™ Wafer Level Chip Scale Package](#).

Ψ<sub>JB</sub> is the junction-to-board thermal characterization parameter with units of °C/W. The Ψ<sub>JB</sub> of the package is based on modeling and calculation using a 4-layer board. The JESD51-12, *Guidelines for Reporting and Using Package Thermal Information*, states that thermal characterization parameters are not the same as thermal resistances. Ψ<sub>JB</sub> measures the component power flowing through multiple thermal paths rather than a single path as in thermal resistance, θ<sub>JB</sub>. Therefore, Ψ<sub>JB</sub> thermal paths include convection from the top of the package as well as radiation from the package, factors that make Ψ<sub>JB</sub> more useful in real-world applications.

Maximum junction temperature (T<sub>J</sub>) is calculated from the board temperature (T<sub>B</sub>) and power dissipation (P<sub>D</sub>) using the formula

$$T_J = T_B + (P_D \times \Psi_{JB})$$

Refer to JESD51-8, JESD51-9, and JESD51-12 for more detailed information about Ψ<sub>JB</sub>.

## THERMAL RESISTANCE

θ<sub>JA</sub> and Ψ<sub>JB</sub> are specified for the worst-case conditions, that is, a device soldered in a circuit board for surface-mount packages.

Table 3. Thermal Resistance

Package Type	θ <sub>JA</sub>	θ <sub>JC</sub>	Ψ <sub>JB</sub>	Unit
4-Ball, 0.5 mm Pitch WLCSP	260	4	58.4	°C/W
8-Lead, 2 mm × 2 mm LFCSP	72.1	42.3	47.1	°C/W

## ESD CAUTION



**ESD (electrostatic discharge) sensitive device.** Charged devices and circuit boards can discharge without detection. Although this product features patented or proprietary protection circuitry, damage may occur on devices subjected to high energy ESD. Therefore, proper ESD precautions should be taken to avoid performance degradation or loss of functionality.

## PIN CONFIGURATIONS AND FUNCTION DESCRIPTIONS

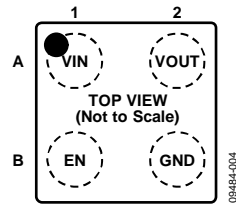
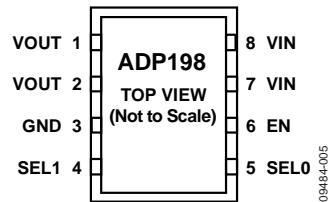

Figure 4. 4-Ball WLCSP Pin Configuration

Table 4. Pin Function Descriptions, WLCSP

Pin No.	Mnemonic	Description
A1	VIN	Input Voltage.
A2	VOUT	Output Voltage.
B1	EN	Enable Input. Drive EN high to turn on the switch and drive EN low to turn off the switch.
B2	GND	Ground.

**NOTES**

1. THE EXPOSED PAD IS CONNECTED TO THE SUBSTRATE OF THE ADP198 AND MUST BE CONNECTED TO GROUND.

Figure 5. 8-Lead LFCSP Pin Configuration

Table 5. Pin Function Descriptions, LFCSP

Pin No.	Mnemonic	Description
1	VOUT	Output Voltage. Connect Pin 1 and Pin 2 together.
2	VOUT	Output Voltage. Connect Pin 1 and Pin 2 together.
3	GND	Ground.
4	SEL1	Select Turn-On Time.
5	SELO	Select Turn-On Time.
6	EN	Enable Input. Drive EN high to turn on the switch and drive EN low to turn off the switch.
7	VIN	Input Voltage. Connect Pin 7 and Pin 8 together.
8	VIN	Input Voltage. Connect Pin 7 and Pin 8 together.
	EP	Exposed Pad. The exposed pad is connected to the substrate of the <a href="#">ADP198</a> and must be connected to ground.

TYPICAL PERFORMANCE CHARACTERISTICS

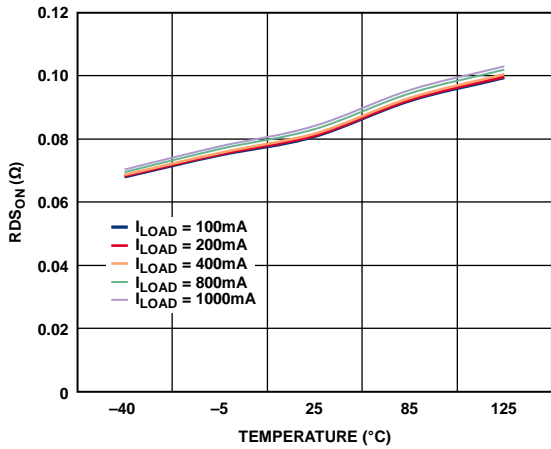

Figure 6.  $R_{DS(on)}$  vs. Temperature, WLCSP

09484-006

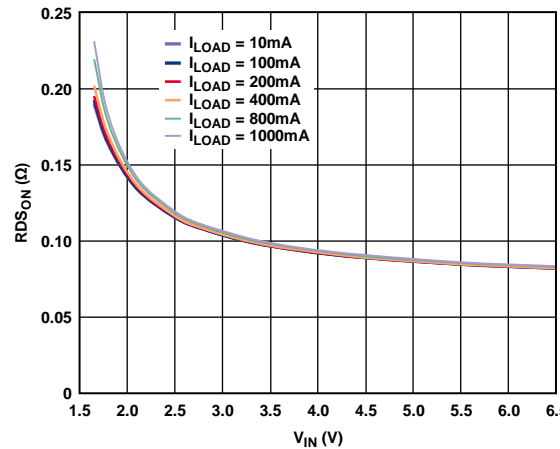

Figure 9.  $R_{DS(on)}$  vs. Input Voltage ( $V_{IN}$ ), LFCSP

09484-009

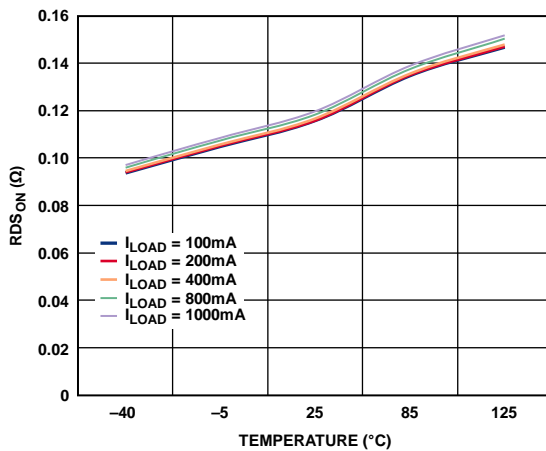

Figure 7.  $R_{DS(on)}$  vs. Temperature, LFCSP

09484-007

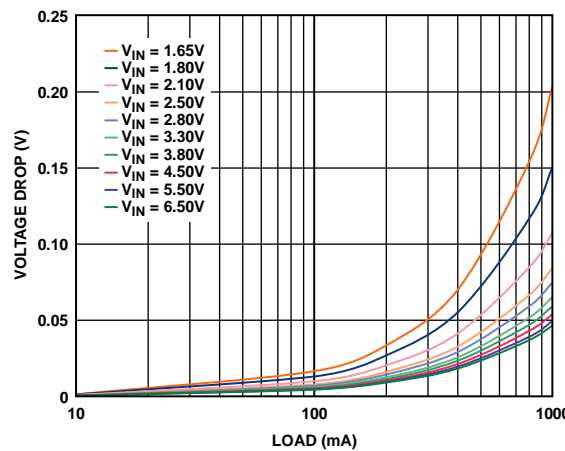

Figure 10. Voltage Drop vs. Load Current, WLCSP

09484-010

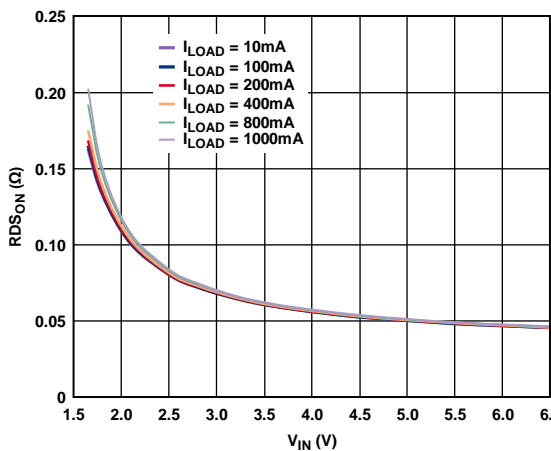

Figure 8.  $R_{DS(on)}$  vs. Input Voltage ( $V_{IN}$ ), WLCSP

09484-008

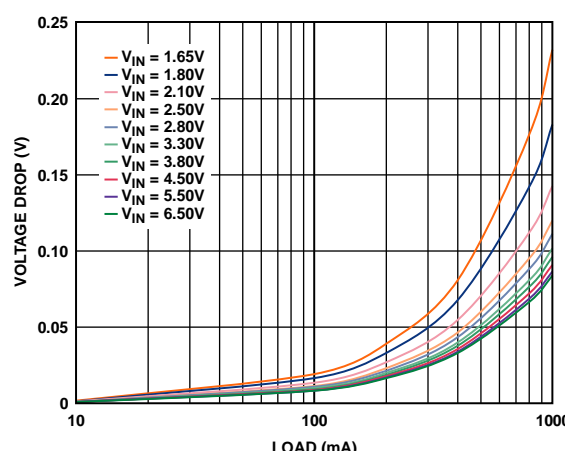

Figure 11. Voltage Drop vs. Load Current, LFCSP

09484-011

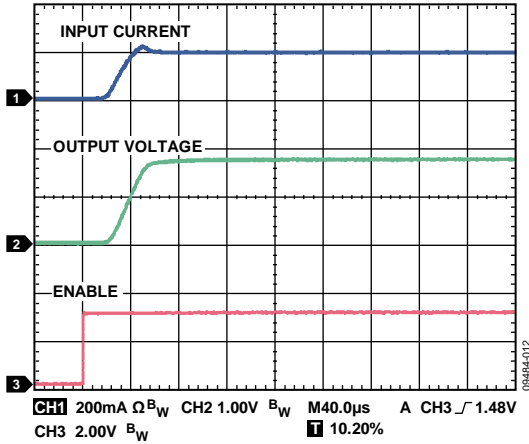

Figure 12. Typical Rise Time and Inrush Current,  $V_{IN} = 1.8V$ ,  $I_{LOAD} = 200mA$ , Select Code 00

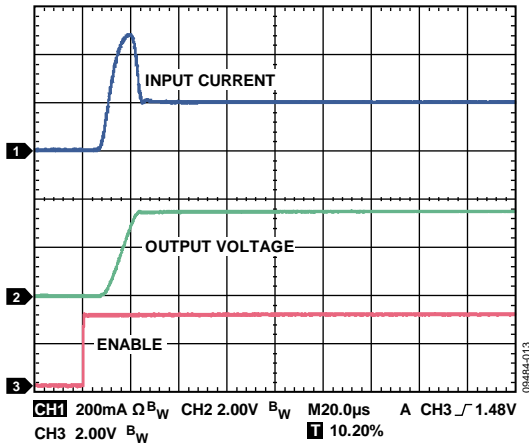

Figure 13. Typical Rise Time and Inrush Current,  $V_{IN} = 3.6V$ ,  $I_{LOAD} = 200mA$ , Select Code 00

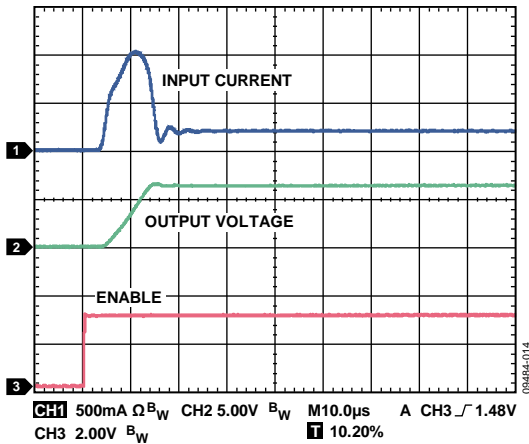

Figure 14. Typical Rise Time and Inrush Current,  $V_{IN} = 6.5V$ ,  $I_{LOAD} = 200mA$ , Select Code 00

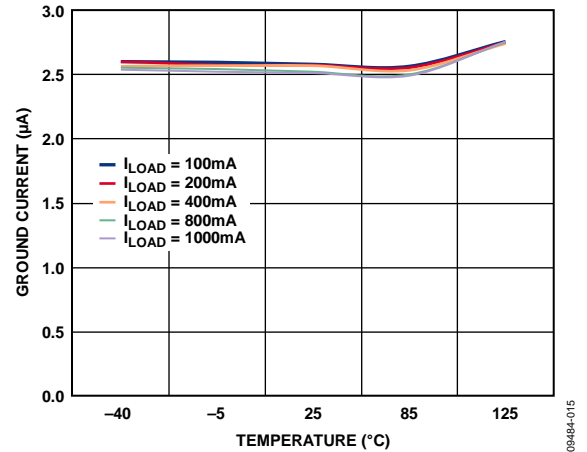

Figure 15. Ground Current vs. Temperature

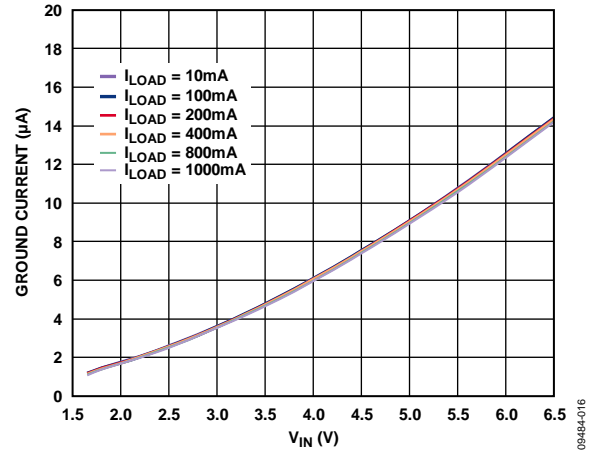

Figure 16. Ground Current vs. Input Voltage ( $V_{IN}$ )

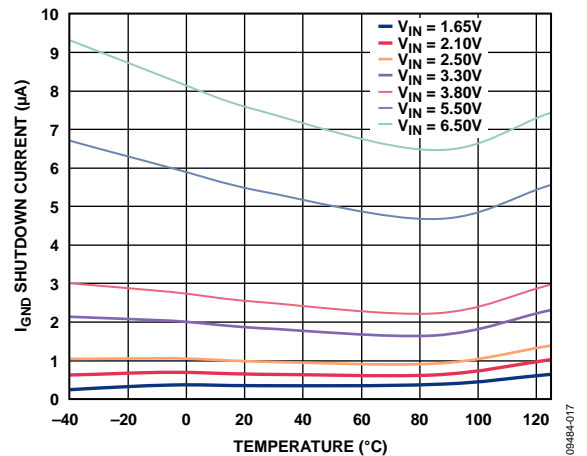

Figure 17.  $I_{GND}$  Shutdown Ground Current vs. Temperature,  $V_{OUT}$  Open

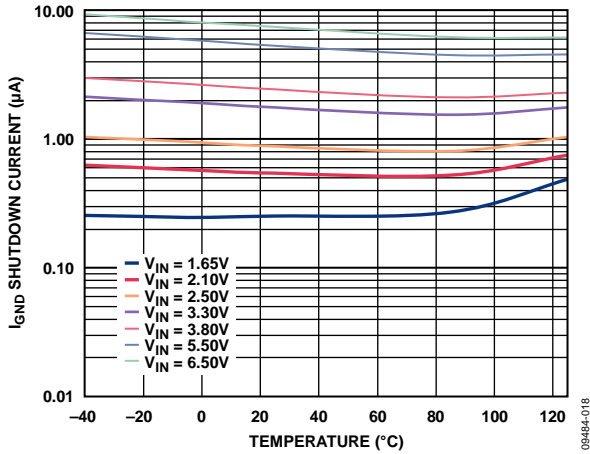

Figure 18. Shutdown Ground Current vs. Temperature,  $V_{OUT} = 0V$

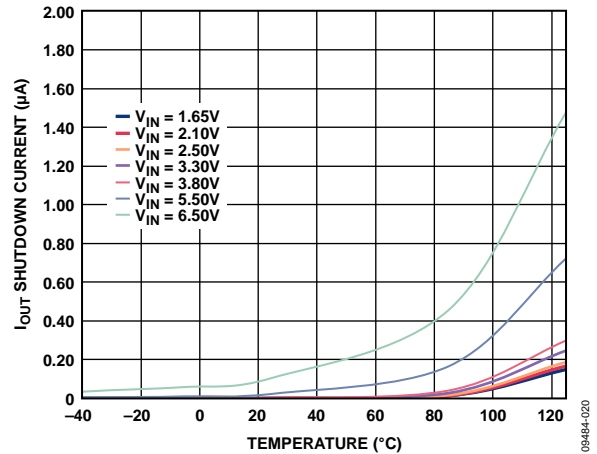

Figure 20. Reverse Input Shutdown Current vs. Temperature,  $V_{IN} = 0V$

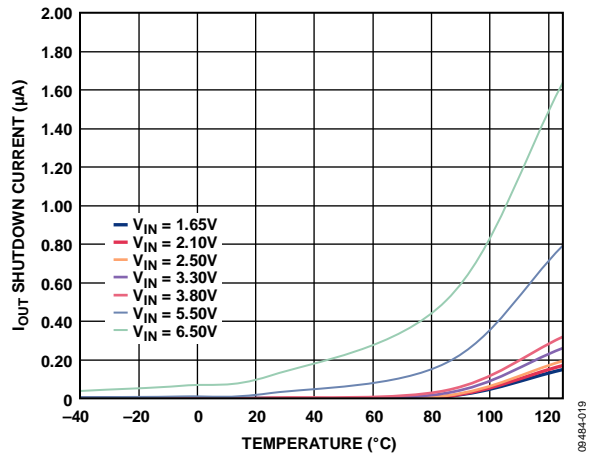

Figure 19.  $I_{OUT}$  Shutdown Current vs. Temperature,  $V_{OUT} = 0V$

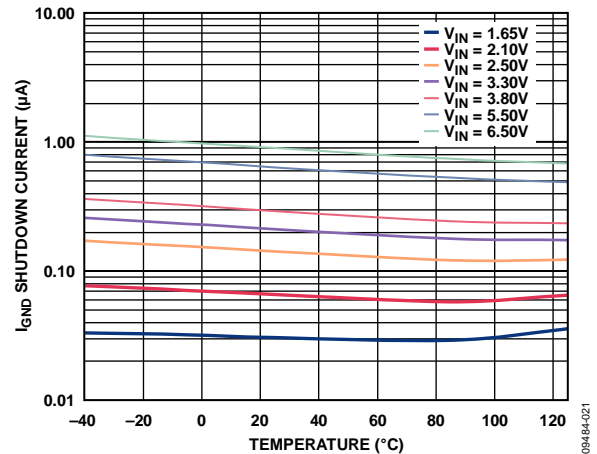

Figure 21. Reverse Shutdown Ground Current vs. Temperature,  $V_{OUT} = 0V$

## THEORY OF OPERATION

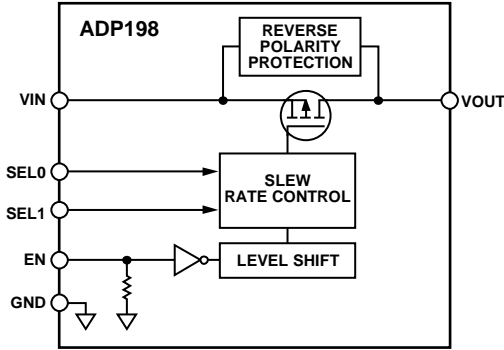

Figure 22. Functional Block Diagram

The [ADP198](#) is a high-side PMOS load switch that is designed for supply operation between 1.65 V and 6.5 V. The PMOS load switch has a low on resistance of 50 m $\Omega$  at  $V_{IN} = 3.3$  V and supports 1 A of continuous load current. The [ADP198](#) features low quiescent current at 2.5  $\mu$ A typical using a 2.8 V supply.

The enable input incorporates a nominal 4 M $\Omega$  pull-down resistor. SEL0 and SEL1 program the start-up time of the load switch to reduce inrush current when the switch is turned on.

The reverse current protection circuitry prevents current from flowing backwards through the [ADP198](#) when the output voltage is greater than the input voltage. A comparator senses the difference between the input and output voltages. When the difference between the input voltage and output voltage exceeds 75 mV, the body of the PFET is switched to VOUT and turned off or opened. In other words, the gate is connected to VOUT.

The packaging is a space-saving 1 mm  $\times$  1 mm, 4-ball WLCSP. The [ADP198](#) is also available in a 2 mm  $\times$  2 mm  $\times$  0.55 mm, 0.5 mm pitch LFCSP.

## APPLICATIONS INFORMATION

### GROUND CURRENT

The major source for ground current in the ADP198 is an internal 4 MΩ pull-down resistor on the enable pin. Figure 23 shows the typical ground current when  $V_{EN} = V_{IN}$  and varies from 1.65 V to 6.5 V.

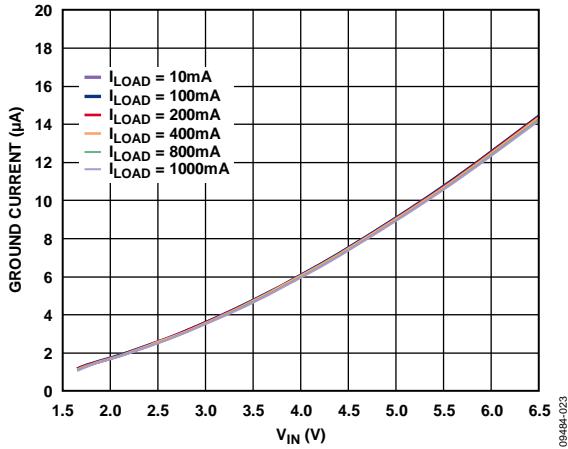

Figure 23. Ground Current vs. Load Current

As shown in Figure 24, an increase in quiescent current can occur when  $V_{EN} \neq V_{IN}$ . This is caused by the CMOS logic nature of the level shift circuitry as it translates a  $V_{EN}$  signal  $\geq 1.2$  V to a logic high. This increase is a function of the  $V_{IN} - V_{EN}$  delta.

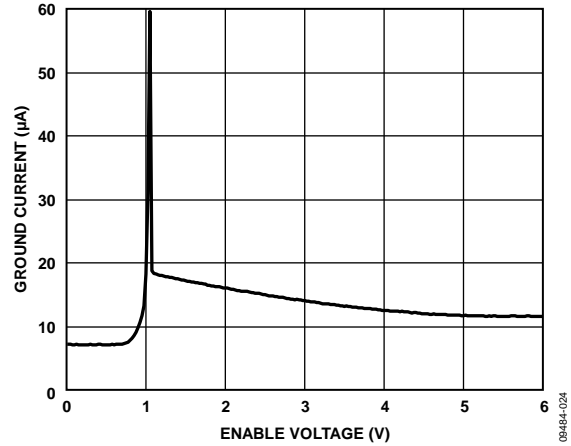

Figure 24. Typical Ground Current when  $V_{EN} \neq V_{IN}$

**ENABLE FEATURE**

The ADP198 uses the EN pin to enable and disable the VOUT pin under normal operating conditions. As shown in Figure 25, when a rising V<sub>EN</sub> voltage crosses the active threshold, VOUT turns on. When a falling V<sub>EN</sub> voltage crosses the inactive threshold, VOUT turns off.

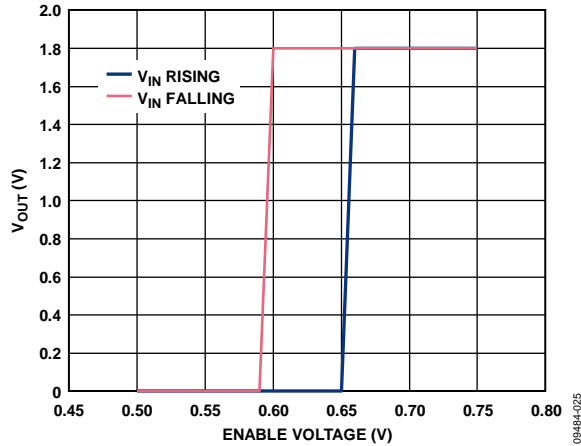

Figure 25. Typical EN Operation

As shown in Figure 25, the EN pin has hysteresis built in. This prevents on/off oscillations that can occur due to noise on the EN pin as it passes through the threshold points.

The EN pin active/inactive thresholds derive from the V<sub>IN</sub> voltage; therefore, these thresholds vary with the changing input voltage. Figure 26 shows the typical EN active/inactive thresholds when the input voltage varies from 1.65 V to 6.5 V.

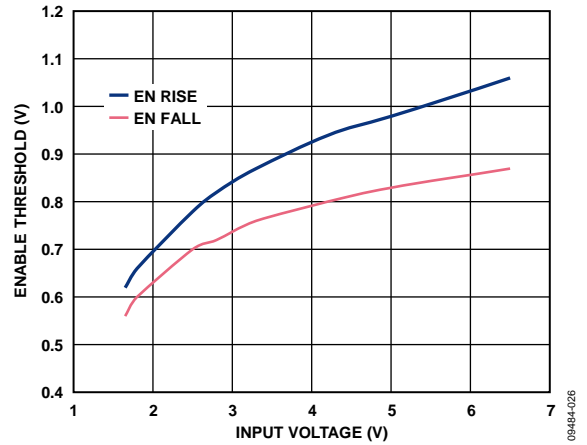

Figure 26. Typical EN Thresholds vs. Input Voltage (V<sub>IN</sub>)

**TIMING**

Turn-on delay is defined as the delta between the time that  $V_{EN}$  reaches  $>1.2\text{ V}$  and when  $V_{OUT}$  rises to  $\sim 10\%$  of its final value. The ADP198 includes circuitry to have typical  $10\ \mu\text{s}$  turn-on delay at  $3.6\text{ V } V_{IN}$  to limit the  $V_{IN}$  inrush current.

The rise time is defined as the delta between the time from  $10\%$  to  $90\%$  of  $V_{OUT}$  reaching its final value. It is dependent on the RC time constant where  $C = \text{load capacitance } (C_{LOAD})$  and  $R = R_{DS(ON)} || R_{LOAD}$ . Because  $R_{DS(ON)}$  is usually smaller than  $R_{LOAD}$ , an adequate approximation for RC is  $R_{DS(ON)} \times C_{LOAD}$ . An input or load capacitor is not needed for the ADP198; however, capacitors can be used to suppress noise on the board. If significant load capacitance is connected, inrush current may be a concern. The start-up time is the sum of the turn-on delay time plus the rise time.

Figure 27 through Figure 30 show the turn-on delay and output rise time for each of the four settings on SEL0 and SEL1.

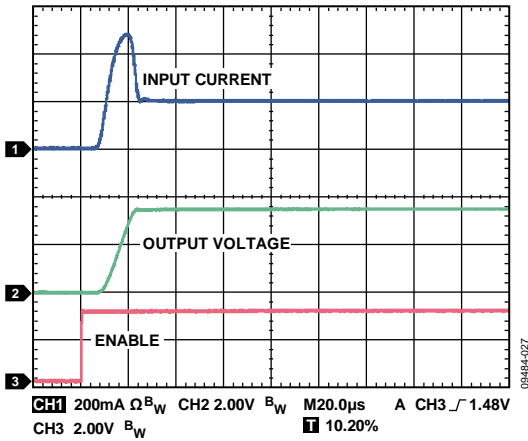

Figure 27. Typical Rise Time and Inrush Current,  $C_{LOAD} = 1\ \mu\text{F}$ ,  $V_{IN} = 3.6\text{ V}$ ,  $I_{LOAD} = 200\text{ mA}$ , Code 00

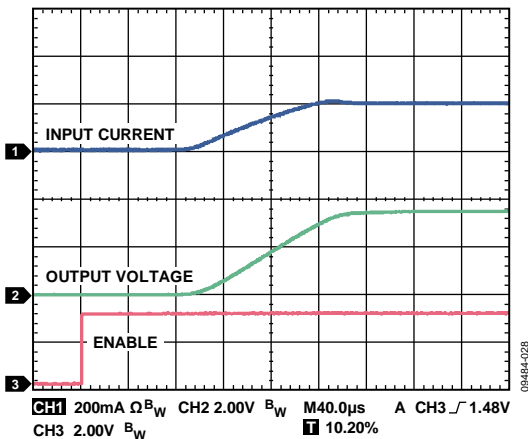

Figure 28. Typical Rise Time and Inrush Current,  $C_{LOAD} = 1\ \mu\text{F}$ ,  $V_{IN} = 3.6\text{ V}$ ,  $I_{LOAD} = 200\text{ mA}$ , Code 01

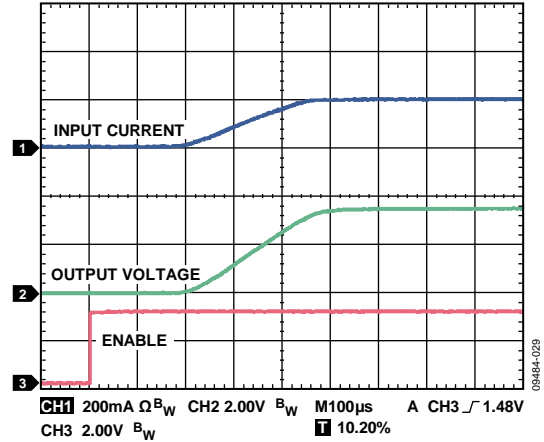

Figure 29. Typical Rise Time and Inrush Current,  $C_{LOAD} = 1\ \mu\text{F}$ ,  $V_{IN} = 3.6\text{ V}$ ,  $I_{LOAD} = 200\text{ mA}$ , Code 10

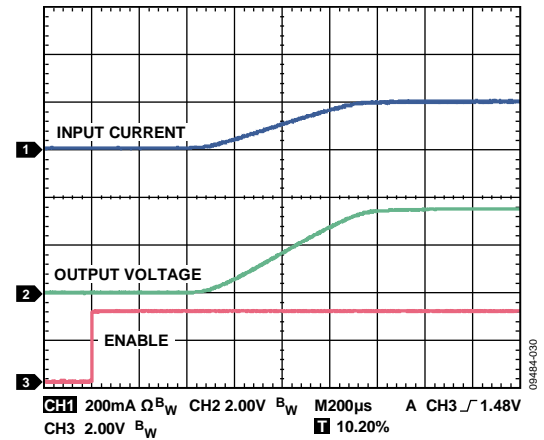

Figure 30. Typical Rise Time and Inrush Current,  $C_{LOAD} = 1\ \mu\text{F}$ ,  $V_{IN} = 3.6\text{ V}$ ,  $I_{LOAD} = 200\text{ mA}$ , Code 11

The turn-off time is defined as the delta between the time from  $90\%$  to  $10\%$  of  $V_{OUT}$  reaching its final value. It is also dependent on the RC time constant.

**Table 6. Start-Up Time Pin Settings**

SEL1	SEL0	Start-Up Time ( $\mu\text{s}$ ) (Turn-On Delay + Rise Time)
0	0	22
0	1	200
1	0	450
1	1	1100

**DIODE OR'ing APPLICATIONS**

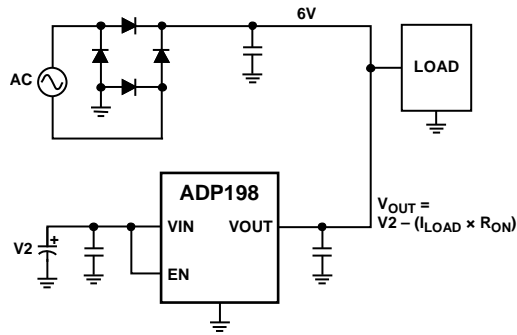

Figure 31. ADP198 in a Typical Diode OR'ing Application

Figure 31 shows an application wherein an ac power supply and battery are OR'ed together to provide a seamless transition from the primary (ac) supply to the secondary (V2) supply when the primary supply is disconnected. By connecting the enable input of the ADP198 to V2, the transition from ac power to battery power is automatic.

Figure 32 shows the forward voltage vs. the forward current characteristics of a Schottky diode and the ADP198. The low on resistance of the ADP198 makes it far superior to a Schottky diode in diode OR'ing applications.

In addition to low on resistance, the ADP198 reverse leakage current is much lower than a typical 1 A, 20 V Schottky

rectifier. For example, at 85°C, the reverse current of a Schottky rectifier can be as high as 30 μA with only 2.5 V of reverse bias.

Figure 32 shows that about 75 mV of hysteresis built into the circuitry that senses the voltage differential between the input and output voltage. When the difference between the input voltage and output voltage exceeds 75 mV, the ADP198 is switched on.

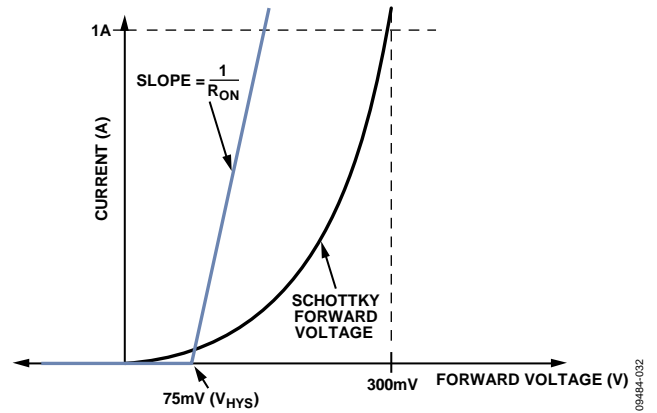

Figure 32. Forward Voltage vs. Forward Current of a Schottky Diode and ADP198

PACKAGING AND ORDERING INFORMATION

OUTLINE DIMENSIONS

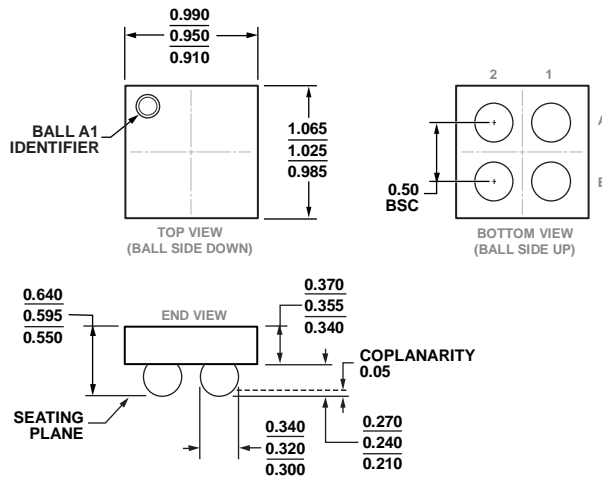

Figure 33. 4-Ball Wafer Level Chip Scale Package [WLCSP] (CB-4-4)

Dimensions shown in millimeters

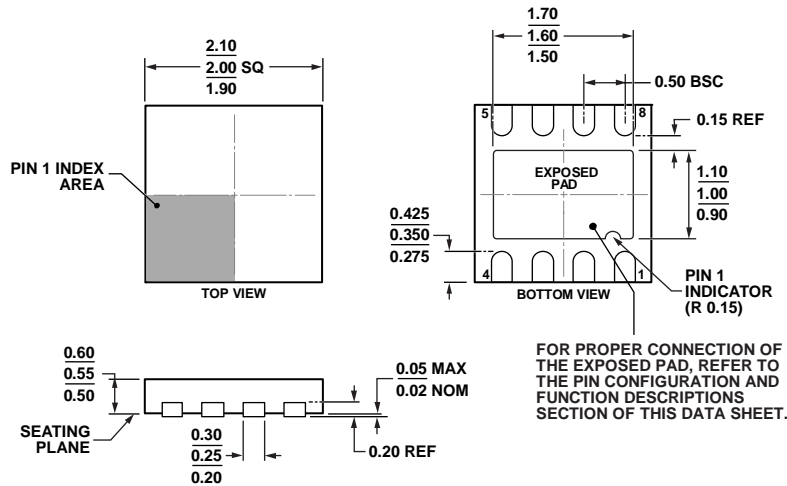

Figure 34. 8-Lead Lead Frame Chip Scale Package [LFCSP\_UD]

2.00 × 2.00 mm Body, Ultra Thin, Dual Lead

(CP-8-10)

Dimensions shown in millimeters

ORDERING GUIDE

Model <sup>1</sup>	Temperature Range	Start-Up Time (μs)	Package Description	Package Option	Branding
ADP198ACBZ-R7	-40°C to +85°C	22	4-Ball Wafer Level Chip Scale Package [WLCSP]	CB-4-4	8C
ADP198ACBZ-11-R7	-40°C to +85°C	1100	4-Ball Wafer Level Chip Scale Package [WLCSP]	CB-4-4	2W
ADP198ACPZ-R7	-40°C to +85°C	Pin selectable: 22, 200, 450, and 1100	8-Lead Lead Frame Chip Scale Package [LFCSP_UD]	CP-8-10	LJL
ADP198CP-EVALZ			Evaluation Board		

<sup>1</sup> Z = RoHS Compliant Part.

## Looking for pricing, stock, or lifecycle information?

Click below to explore more details on WIN SOURCE:

- ⊖ [View ADP198ACBZ-11-R7 on WIN SOURCE](#)
- ⊖ [Analog Devices Inc. Information](#)

## Optimize Your Supply Chain with WIN SOURCE Solutions

- ✓ Global Sourcing Solution
- ✓ Obsolete Management
- ✓ Cost Control Management
- ✓ Shortage Management
- ✓ Alternative Solution
- ✓ Excess Inventory Management