



# THE DATASHEET OF SD103AW-TP





Micro Commercial Components



Micro Commercial Components  
 20736 Marilla Street Chatsworth  
 CA 91311  
 Phone: (818) 701-4933  
 Fax: (818) 701-4939

# SD103AW THRU SD103CW

## Features

- Halogen free available upon request by adding suffix "-HF"
- Lead Free Finish/RoHS Compliant("P" Suffix designates RoHS Compliant. See ordering information)
- Guard Ring Protection
- Low Forward Voltage Drop
- Low Power Loss For High Efficiency
- Device Marking Code: SD103AW: S4  
 SD103BW: S5  
 SD103CW: S6

## Maximum Ratings

- Epoxy meets UL 94 V-0 flammability rating
- Moisture Sensitivity Level 1
- Operating Temperature: -55°C to +125°C
- Storage Temperature: -55°C to +150°C
- Maximum Thermal Resistance; 300°C/W Junction to Ambient

MCC Part Number	Maximum Recurrent Peak Reverse Voltage	Maximum RMS Voltage	Maximum DC Blocking Voltage
SD103AW	40V	28V	40V
SD103BW	30V	21V	30V
SD103CW	20V	14V	20V

## Electrical Characteristics @ 25°C Unless Otherwise Specified

Average Forward Current	$I_{F(AV)}$	350mA	Note 1
Peak Forward Surge Current	$I_{FSM}$	1.5A	$t \leq 1.0s$
Maximum Power Dissipation	$P_D$	400mW	Note 1
Maximum (Note2) Instantaneous Forward Voltage	$V_F$	0.37V 0.60V	$I_{FM} = 20mA$ $I_{FM} = 200mA$
Maximum DC Reverse Current At Rated DC Blocking Voltage	$I_R$	5.0µA	$V_R = 30V$ (AW) $V_R = 20V$ (BW) $V_R = 10V$ (CW)
Typical Junction Capacitance	$C_j$	50pF	Measured at 1.0MHz, $V_R=0V$
Typical Reverse Recovery Time	$t_{rr}$	10ns	$I_F = I_R = 200mA$ $I_{rr} = 0.1 \times I_R$ $R_L = 100\Omega$

Note: 1. Valid provided that electrodes are kept at ambient Temperature  
 2. Pulse test: Pulse width 300 µsec, Duty cycle 2%

## 400mW Small Signal Schottky Diode 20 to 40 Volts

### SOD-123

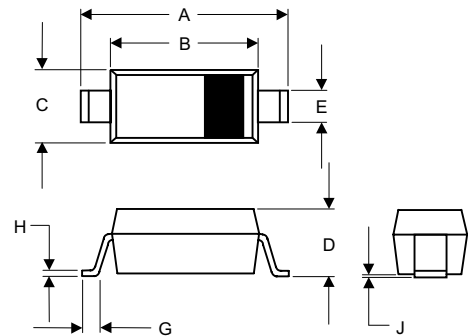

DIM	INCHES		MM		NOTE
	MIN	MAX	MIN	MAX	
A	.140	.152	3.55	3.85	
B	.100	.112	2.55	2.85	
C	.055	.071	1.40	1.80	
D	---	.053	---	1.35	
E	.012	.031	0.30	0.78	
G	.006	---	0.15	---	
H	---	.010	---	0.25	
J	---	.006	---	0.15	

### SUGGESTED SOLDER PAD LAYOUT

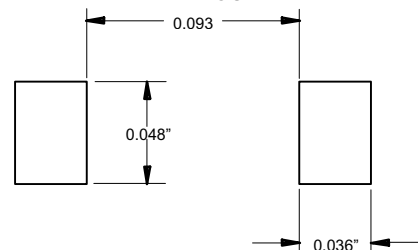

# SD103AW thru SD103CW

Figure 1  
Typical Forward Characteristics

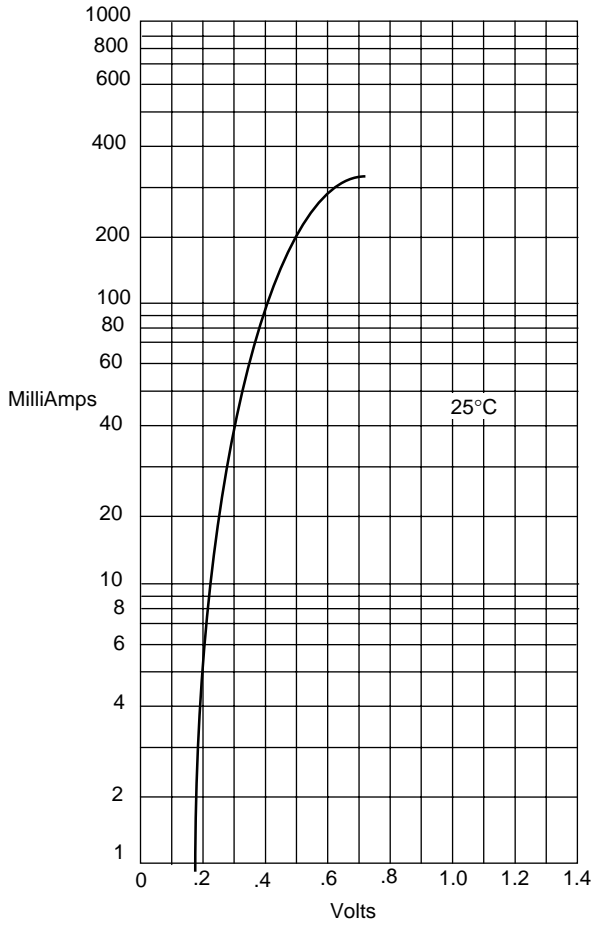

Figure 2  
Typical Junction Capacitance

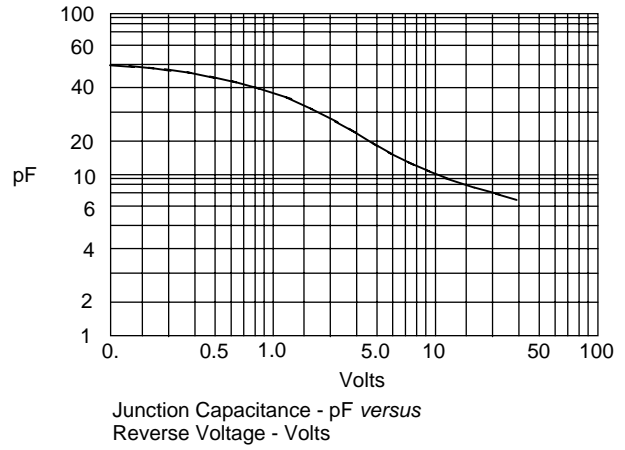
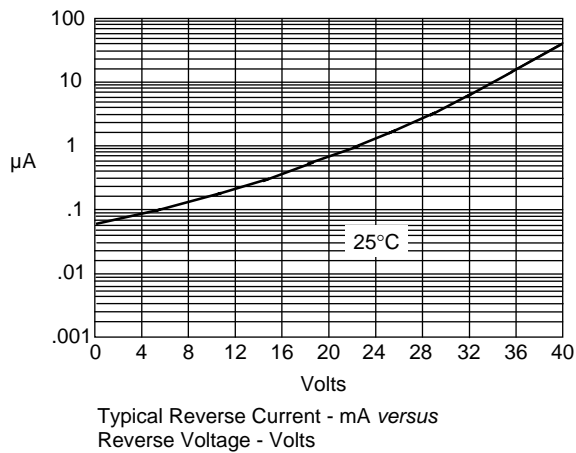

Figure 3  
Typical Reverse Characteristics





TM

Micro Commercial Components

### Ordering Information :

Device	Packing
Part Number-TP	Tape&Reel: 3Kpcs/Reel

Note : Adding "-HF" suffix for halogen free, eg. Part Number-TP-HF

#### \*\*\*IMPORTANT NOTICE\*\*\*

**Micro Commercial Components Corp.** reserves the right to make changes without further notice to any product herein to make corrections, modifications , enhancements , improvements , or other changes . **Micro Commercial Components Corp .** does not assume any liability arising out of the application or use of any product described herein; neither does it convey any license under its patent rights ,nor the rights of others . The user of products in such applications shall assume all risks of such use and will agree to hold **Micro Commercial Components Corp .** and all the companies whose products are represented on our website, harmless against all damages.

#### \*\*\*LIFE SUPPORT\*\*\*

MCC's products are not authorized for use as critical components in life support devices or systems without the express written approval of Micro Commercial Components Corporation.



#### \*\*\*CUSTOMER AWARENESS\*\*\*

Counterfeiting of semiconductor parts is a growing problem in the industry. Micro Commercial Components (MCC) is taking strong measures to protect ourselves and our customers from the proliferation of counterfeit parts. MCC strongly encourages customers to purchase MCC parts either directly from MCC or from Authorized MCC Distributors who are listed by country on our web page cited below. Products customers buy either from MCC directly or from Authorized MCC Distributors are genuine parts, have full traceability, meet MCC's quality standards for handling and storage. **MCC will not provide any warranty coverage or other assistance for parts bought from Unauthorized Sources.** MCC is committed to combat this global problem and encourage our customers to do their part in stopping this practice by buying direct or from authorized distributors.

[www.mccsemi.com](http://www.mccsemi.com)

## Looking for pricing, stock, or lifecycle information?

Click below to explore more details on WIN SOURCE:

-  [View SD103AW-TP on WIN SOURCE](#)
-  [Micro Commercial Co](#) Information

## Optimize Your Supply Chain with WIN SOURCE Solutions

-  Global Sourcing Solution
-  Obsolete Management
-  Cost Control Management
-  Shortage Management
-  Alternative Solution
-  Excess Inventory Management