

Serial EEPROM Series Standard EEPROM
SPI BUS EEPROM



BR25Lxxx-W Series (1K 2K 4K 8K 16K 32K 64K)

●General Description

BR25Lxxx-W series is a serial EEPROM of SPI BUS interface method.

●Features

- High speed clock action up to 5MHz (Max.)
- Wait function by HOLD terminal
- Part or whole of memory arrays settable as read only memory area by program
- 1.8V to 5.5V single power source action most suitable for battery use
- Page write mode useful for initial value write at factory shipment
- Highly reliable connection by Au pad and Au wire
- For SPI bus interface
(CPOL, CPHA) = (0, 0), (1, 1)
- Auto erase and auto end function at data rewrite
- Low current consumption
 - At write action (5V) : 1.5mA (Typ.)
 - At read action (5V) : 1.0mA (Typ.)
 - At standby action (5V) : 0.1μA (Typ.)
- Address auto increment function at read action
- Write mistake prevention function
 - Write prohibition at power on
 - Write prohibition by command code (WRDI)
 - Write prohibition by \overline{WP} pin
 - Write prohibition block setting by status registers (BP1, BP0)
 - Write mistake prevention function at low voltage
- Data at shipment Memory array : FFh, status register WPEN, BP1, BP0 : 0
- Data kept for 40 years
- Data rewrite up to 1,000,000 times

●Packages W(Typ.) x D(Typ.) x H(Max.)

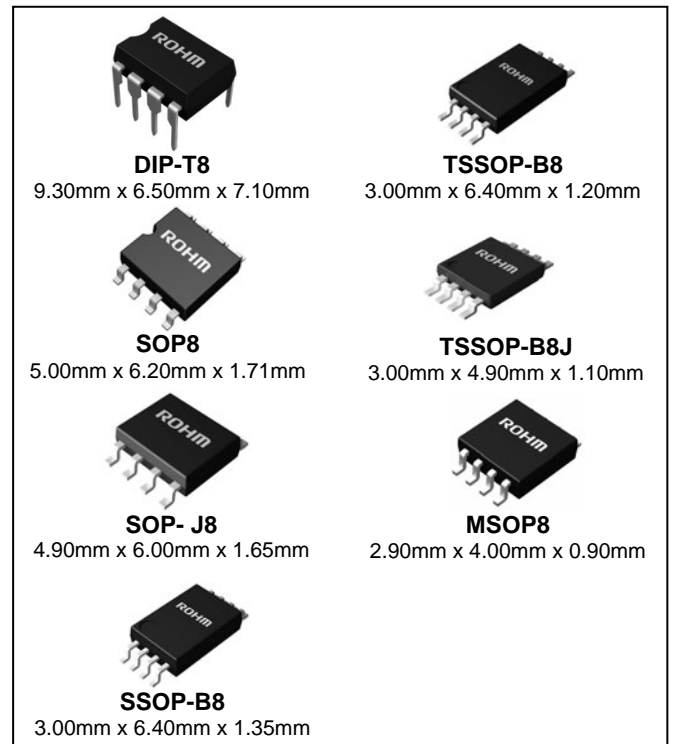

●Page write

Number of pages	16Byte	32Byte
Product number	BR25L010-W BR25L020-W BR25L040-W	BR25L080-W BR25L160-W BR25L320-W BR25L640-W

●BR25L Series

Capacity	Bit format	Type	Power source voltage	DIP-T8	SOP8	SOP-J8	SSOP-B8	TSSOP-B8	MSOP8	TSSOP-B8J
					F	FJ	FV	FVT	FVM	FVJ
1Kbit	128 X 8	BR25L010-W	1.8 ~ 5.5V		●	●	●	●	●	●
2Kbit	256 X 8	BR25L020-W	1.8 ~ 5.5V		●	●	●	●	●	●
4Kbit	512 X 8	BR25L040-W	1.8 ~ 5.5V	●	●	●	●	●	●	●
8Kbit	1K X 8	BR25L080-W	1.8 ~ 5.5V	●	●	●	●	●		
16Kbit	2K X 8	BR25L160-W	1.8 ~ 5.5V	●	●	●	●	●		
32Kbit	4K X 8	BR25L320-W	1.8 ~ 5.5V	●	●	●				
64Kbit	8K X 8	BR25L640-W	1.8 ~ 5.5V	●	●	●				

○Product structure : Silicon monolithic integrated circuit ○This product is not designed protection against radioactive rays

● Absolute Maximum Ratings (Ta=25°C)

Parameter	Symbol	Limits	Unit	Remarks
Impressed voltage	V _{CC}	-0.3 to +6.5	V	
Permissible dissipation	Pd	800 (DIP-T8)	mW	When using at Ta=25°C or higher, 8.0mW to be reduced per 1°C.
		450 (SOP8)		When using at Ta=25°C or higher, 4.5mW to be reduced per 1°C.
		450 (SOP-J8)		When using at Ta=25°C or higher, 4.5mW to be reduced per 1°C.
		300 (SSOP-B8)		When using at Ta=25°C or higher, 3.0mW to be reduced per 1°C.
		330 (TSSOP-B8)		When using at Ta=25°C or higher, 3.3mW to be reduced per 1°C.
		310 (MSOP8)		When using at Ta=25°C or higher, 3.1mW to be reduced per 1°C.
		310 (TSSOP-B8J)		When using at Ta=25°C or higher, 3.1mW to be reduced per 1°C.
Storage temperature range	T _{stg}	-65 to +125	°C	
Operating temperature range	T _{opr}	-40 to +85	°C	
Terminal Voltage	-	-0.3 to V _{CC} +0.3	V	

● Memory cell characteristics (Ta=25°C, V_{CC}=1.8V to 5.5V)

Parameter	Limits			Unit
	Min.	Typ.	Max.	
Number of data rewrite times *1	1,000,000	-	-	Times
Data hold years *1	40	-	-	Years

*1 Not 100% TESTED

● Recommended Operating Ratings

Parameter	Symbol	Limits	Unit
Power source voltage	V _{CC}	1.8 to 5.5	V
Input voltage	V _{IN}	0 to V _{CC}	

● Input / output capacity (Ta=25°C, frequency=5MHz)

Parameter	Symbol	Min.	Max.	Unit	Conditions
Input capacity *1	C _{IN}	—	8	pF	V _{IN} =GND
Output capacity *1	C _{OUT}	—	8		V _{OUT} =GND

*1 Not 100% TESTED.

● Electrical Characteristics (Unless otherwise specified, Ta=-40°C to +85°C, V_{CC}=1.8V to 5.5V)

Parameter	Symbol	Limits			Unit	Conditions
		Min.	Typ.	Max.		
"H" input voltage1	V _{IH}	0.7V _{CC}	—	V _{CC} +0.3	V	1.8V ≤ V _{CC} ≤ 5.5V
"L" input voltage1	V _{IL}	-0.3	—	0.3V _{CC}	V	1.8V ≤ V _{CC} ≤ 5.5V
"L" output voltage1	V _{OL1}	0	—	0.4	V	I _{OL} =2.1mA(V _{CC} =2.5V to 5.5V)
"L" output voltage2	V _{OL2}	0	—	0.2	V	I _{OL} =150μA(V _{CC} =1.8V to 2.5V)
"H" output voltage1	V _{OH1}	V _{CC} -0.5	—	V _{CC}	V	I _{OH} =-0.4mA(V _{CC} =2.5V to 5.5V)
"H" output voltage2	V _{OH2}	V _{CC} -0.2	—	V _{CC}	V	I _{OH} =-100μA(V _{CC} =1.8V to 2.5V)
Input leak current	I _{LI}	-1	—	1	μA	V _{IN} =0 to V _{CC}
Output leak current	I _{LO}	-1	—	1	μA	V _{OUT} =0 to V _{CC} , \overline{CS} =V _{CC}
Current consumption at write action	I _{CC1}	—	—	1.0	mA	V _{CC} =1.8V, f _{SCK} =2MHz, t _{E/W} =5ms Byte write, Page write, Write status register
	I _{CC2}	—	—	2.0	mA	V _{CC} =2.5V, f _{SCK} =5MHz, t _{E/W} =5ms Byte write, Page write, Write status register
	I _{CC3}	—	—	3.0	mA	V _{CC} =5.5V, f _{SCK} =5MHz, t _{E/W} =5ms Byte write, Page write, Write status register
Current consumption at read action	I _{CC4}	—	—	1.5	mA	V _{CC} =2.5V, f _{SCK} =5MHz Read, Read status register
	I _{CC5}	—	—	2.0	mA	V _{CC} =5.5V, f _{SCK} =5MHz Read, Read status register
Standby current	I _{SB}	—	—	2	μA	V _{CC} =5.5V, SO=OPEN CS=HOLD=WP=V _{CC} , SCK=SI=V _{CC} or =GND

● Operating timing characteristics (Ta=-40°C to +85°C, unless otherwise specified, load capacity CL1 100pF)

Parameter	Symbol	1.8V ≤ Vcc < 2.5V			2.5V ≤ Vcc < 5.5V			Unit
		Min.	Typ.	Max.	Min.	Typ.	Max.	
SCK frequency	fSCK	-	-	2	-	-	5	MHz
SCK high time	tSCKWH	200	-	-	85	-	-	ns
SCK low time	tSCKWL	200	-	-	85	-	-	ns
$\overline{\text{CS}}$ high time	tCS	200	-	-	85	-	-	ns
$\overline{\text{CS}}$ setup time	tCSS	200	-	-	90	-	-	ns
$\overline{\text{CS}}$ hold time	tCSH	200	-	-	85	-	-	ns
SCK setup time	tSCKS	200	-	-	90	-	-	ns
SCK hold time	tSCKH	200	-	-	90	-	-	ns
SI setup time	tDIS	40	-	-	20	-	-	ns
SI hold time	tDIH	50	-	-	40	-	-	ns
Data output delay time 1	tPD1	-	-	150	-	-	70	ns
Data output delay time 2 (CL2=30pF)	tPD2	-	-	145	-	-	55	ns
Output hold time	tOH	0	-	-	0	-	-	ns
Output disable time	tOZ	-	-	250	-	-	100	ns
$\overline{\text{HOLD}}$ setting setup time	tHFS	120	-	-	60	-	-	ns
$\overline{\text{HOLD}}$ setting hold time	tHFH	90	-	-	40	-	-	ns
$\overline{\text{HOLD}}$ release setup time	tHRS	120	-	-	60	-	-	ns
$\overline{\text{HOLD}}$ release hold time	tHRH	140	-	-	70	-	-	ns
Time from $\overline{\text{HOLD}}$ to output High-Z	tHOZ	-	-	250	-	-	100	ns
Time from $\overline{\text{HOLD}}$ to output change	tHPD	-	-	150	-	-	70	ns
SCK rise time *1	tRC	-	-	1	-	-	1	μs
SCK fall time *1	tFC	-	-	1	-	-	1	μs
OUTPUT rise time *1	tRO	-	-	100	-	-	50	ns
OUTPUT fall time *1	tFO	-	-	100	-	-	50	ns
Write time	tE/W	-	-	5	-	-	5	ms

*1 NOT 100% TESTED

● AC measurement conditions

Parameter	Symbol	Limits			Unit
		Min.	Typ.	Max.	
Load capacity 1	CL1	-	-	100	pF
Load capacity 2	CL2			30	pF
Input rise time	-	-	-	50	ns
Input fall time	-	-	-	50	ns
Input voltage	-	0.2Vcc/0.8Vcc			V
Input / output judgment voltage	-	0.3Vcc/0.7Vcc			V

● Sync data input / output timing

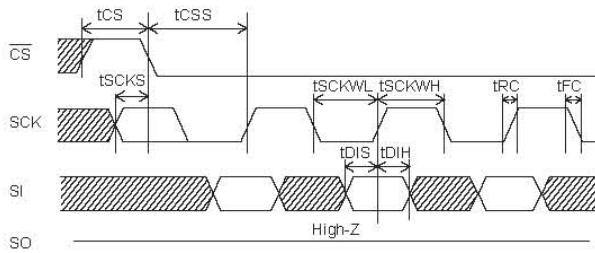

Figure 1. Input timing

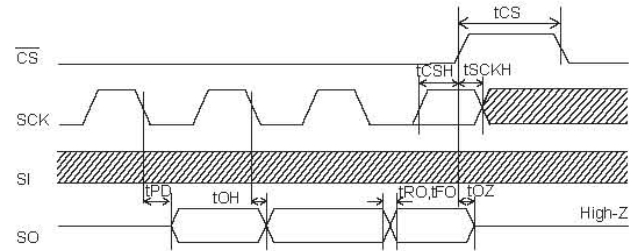
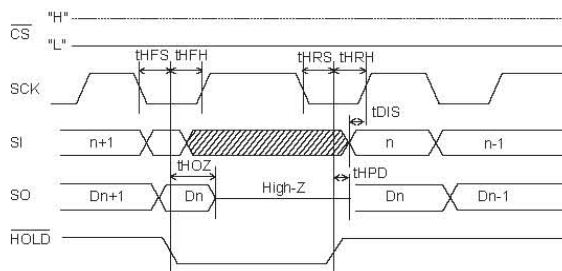

Figure 2. Input / output timing

SI is taken into IC inside in sync with data rise edge of SCK. Input address and data from the most significant bit MSB.

SO is output in sync with data fall edge of SCK. Data is output from the most significant bit MSB.

Figure 3. $\overline{\text{HOLD}}$ timing

●Block Diagram

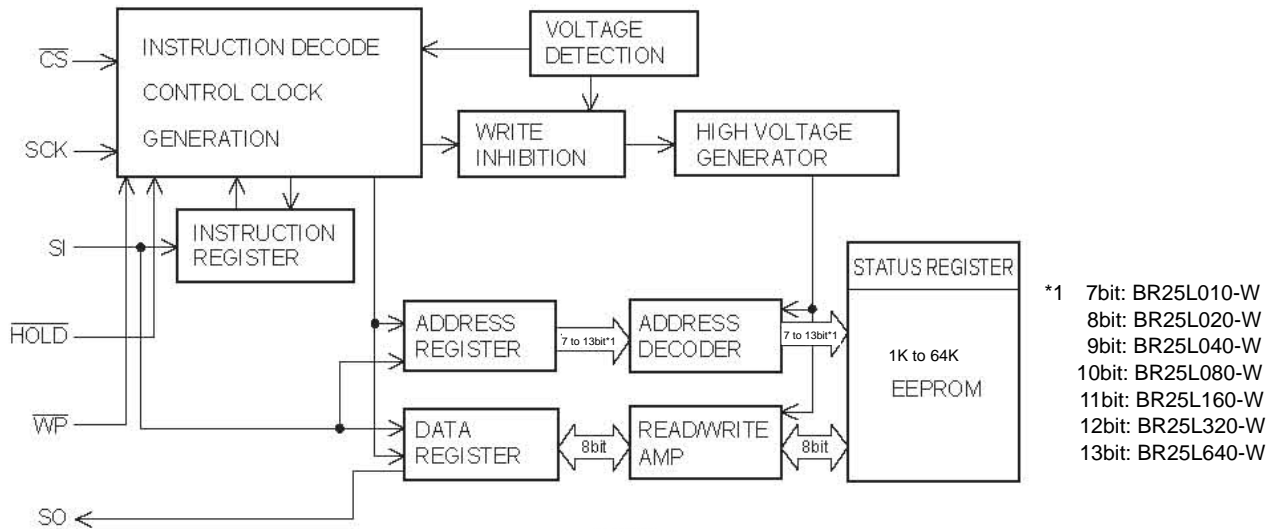

●Pin Configuration

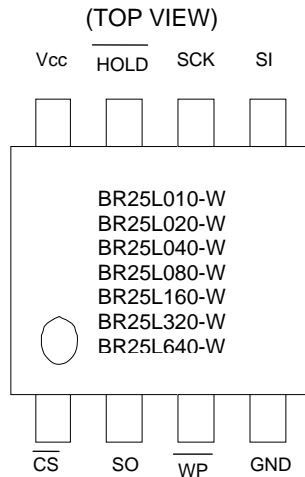

●Pin Descriptions

Terminal name	Input /output	Function
Vcc	-	Power source to be connected
GND	-	All input / output reference voltage, 0V
$\overline{\text{CS}}$	Input	Chip select input
SCK	Input	Serial clock input
SI	Input	Start bit, ope code, address, and serial data input
SO	Output	Serial data output
$\overline{\text{HOLD}}$	Input	Hold input Command communications may be suspended temporarily (HOLD status).
$\overline{\text{WP}}$	Input	Write protect input Write command is prohibited. *1 Write status register command is prohibited.

*1:BR25L010/020/040-W

● Typical Performance Curves

(The following characteristic data are Typ. Values.)

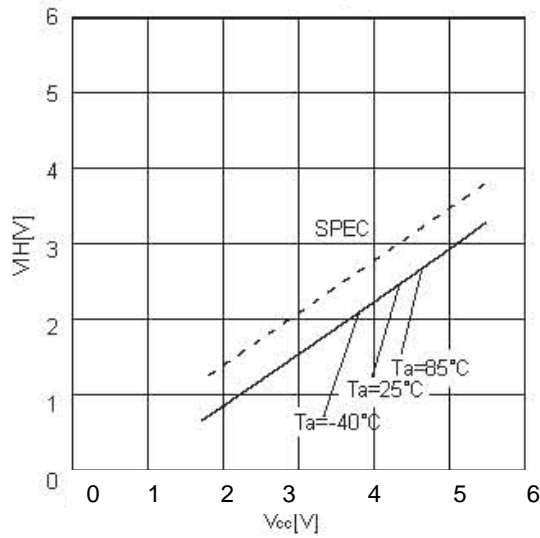

Figure 4. "H" input voltage V_{IH}
(\overline{CS} , \overline{SCK} , \overline{SI} , \overline{HOLD} , \overline{WP})

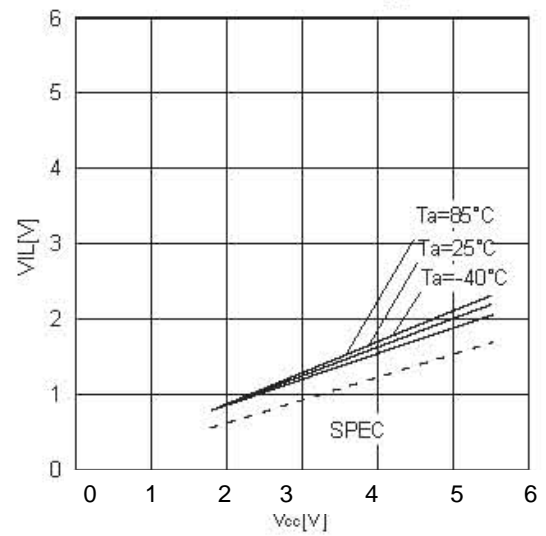

Figure 5. "L" input voltage V_{IL}
(\overline{CS} , \overline{SCK} , \overline{SI} , \overline{HOLD} , \overline{WP})

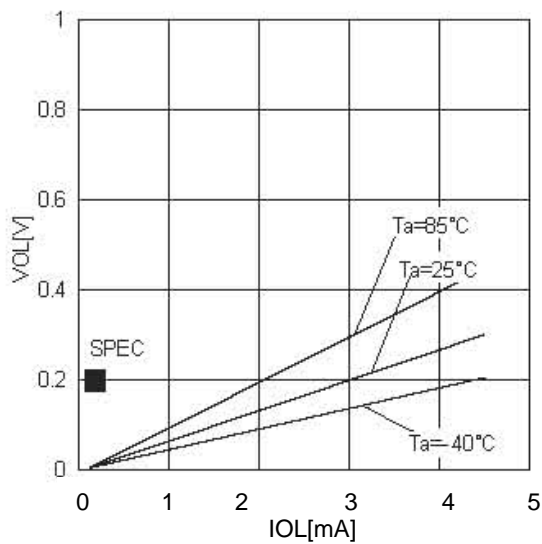

Figure 6. "L" output voltage V_{OL} - I_{OL} ($V_{CC}=1.8V$)

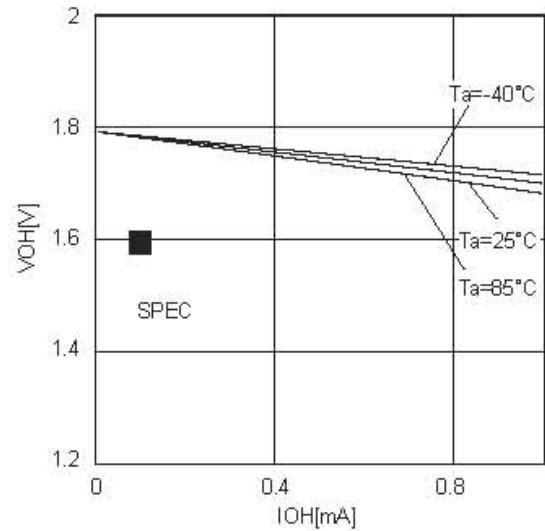

Figure 7. "H" output voltage V_{OH} - I_{OH} ($V_{CC}=1.8V$)

● Typical Performance Curves - Continued

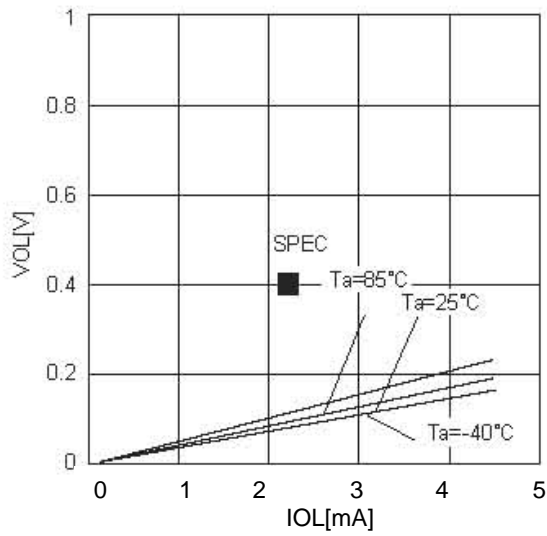

Figure 8. "L" output voltage VOL-IOL (Vcc=2.5V)

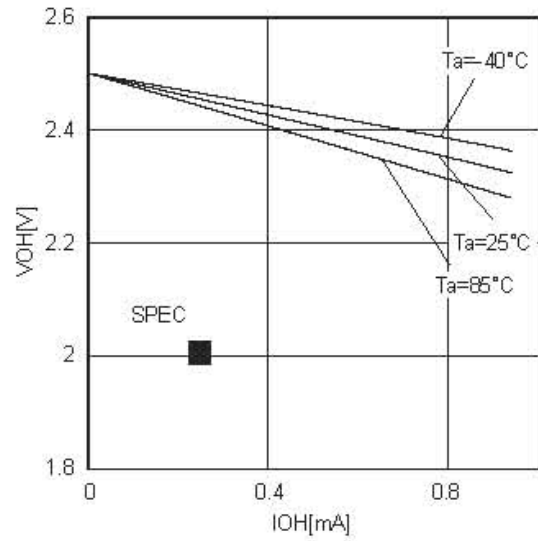

Figure 9. "H" output voltage VOH-IOH (Vcc=2.5V)

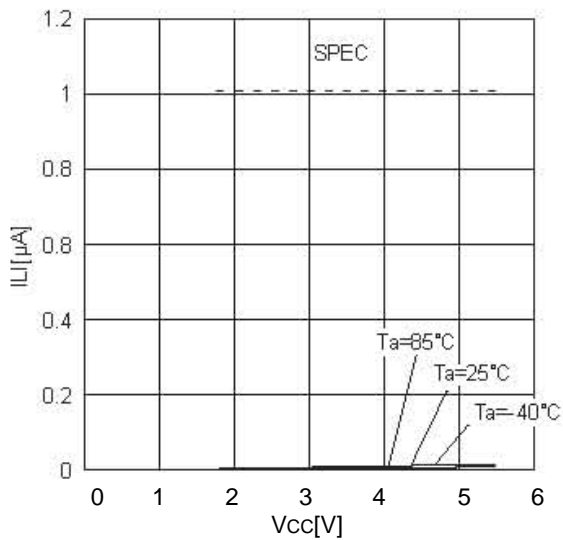

Figure 10. Input leak current ILI
(\overline{CS} , \overline{SCK} , \overline{SI} , \overline{WP} , \overline{HOLD})

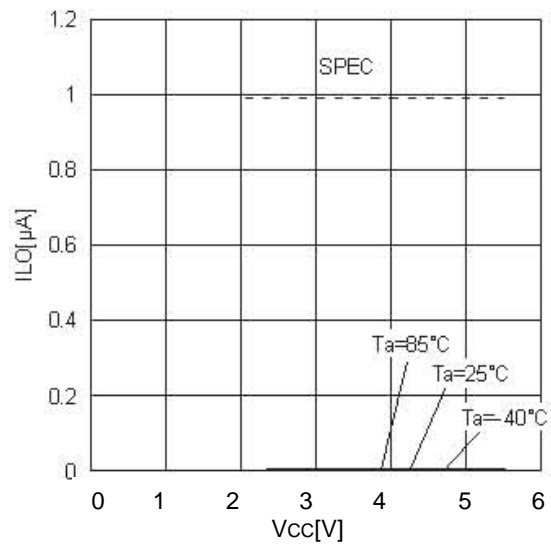

Figure 11. Output leak current ILO(SO)

● Typical Performance Curves - Continued

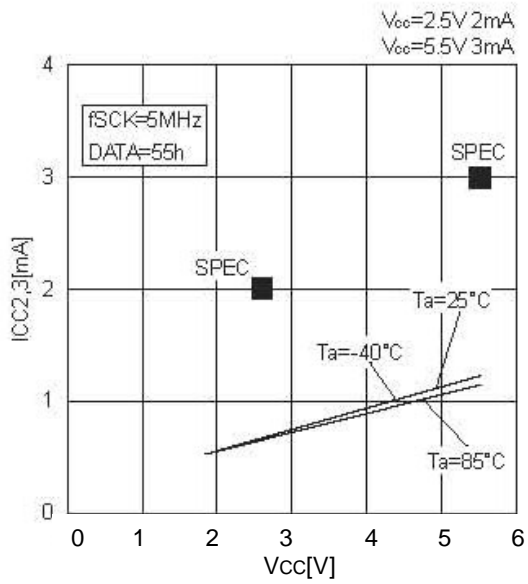

Figure 12. Current consumption at WRITE operation ICC1,2,3 (WRITE, PAGE WRITE, WRSR, fSCK=5MHz) BR25L010-W, BR25L020-W, BR25L040-W

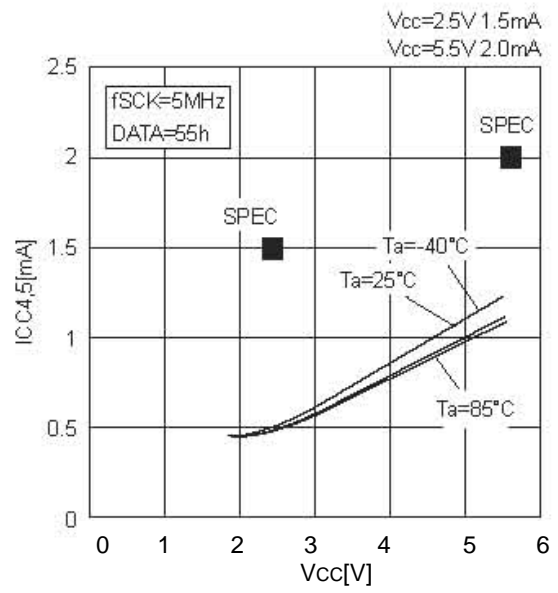

Figure 13. Consumption current at READ operation ICC4,5 (READ, WRSR, fSK=5MHz)

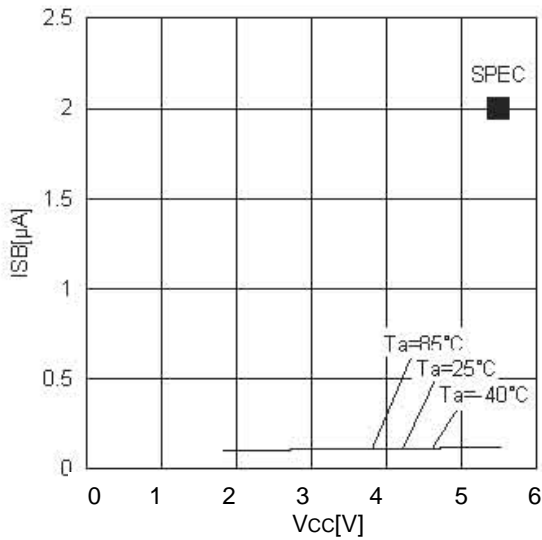

Figure 14. Consumption current at standby operation ISB

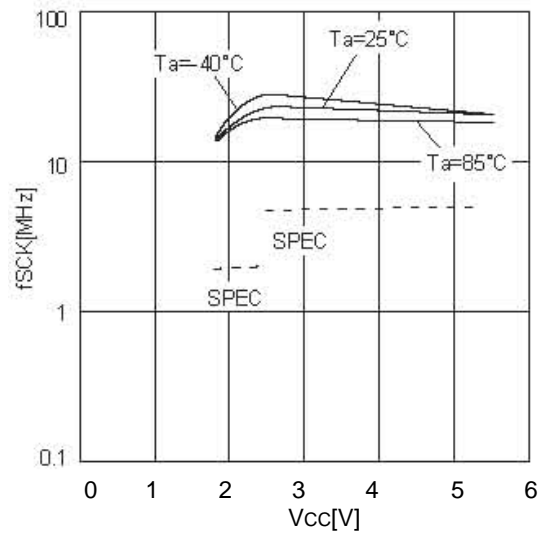

Figure 15. SCK frequency tSCK

● Typical Performance Curves - Continued

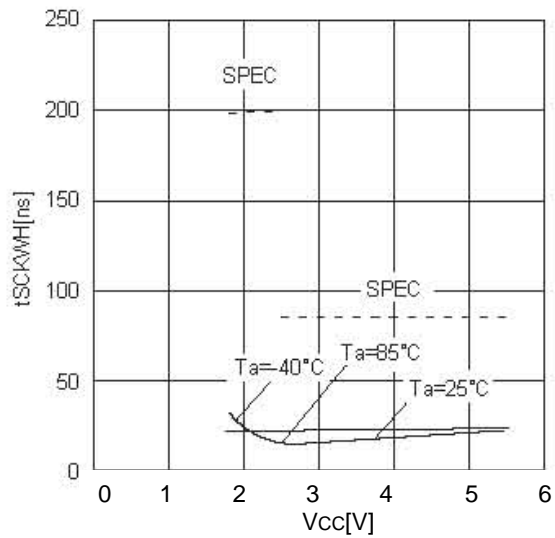

Figure 16. tSCK high time tSCKWH

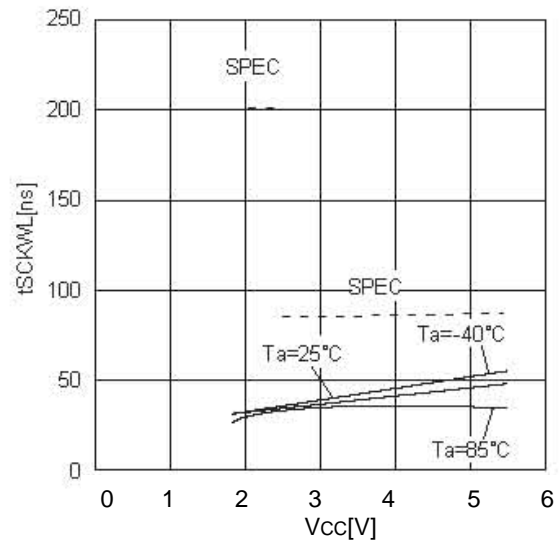

Figure 17. SCK low time tSCKWL

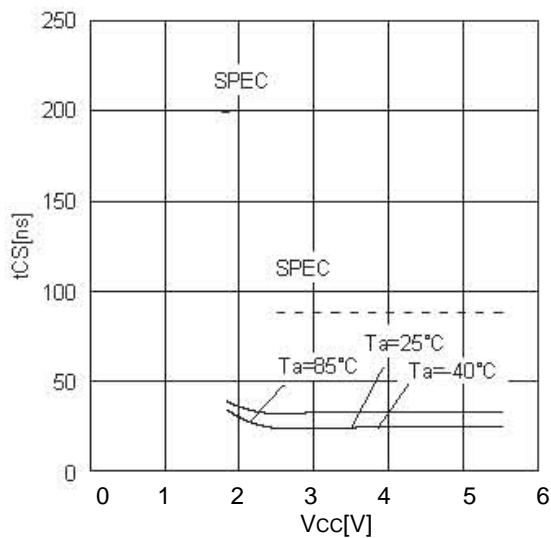

Figure 18. CS high time tCS

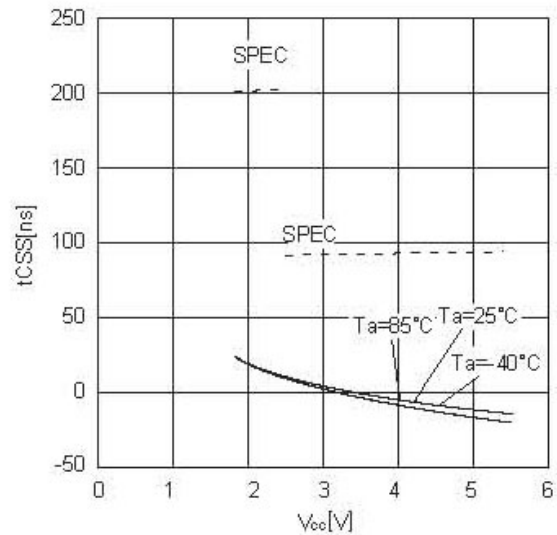

Figure 19. CS setup time tCSS

● Typical Performance Curves - Continued

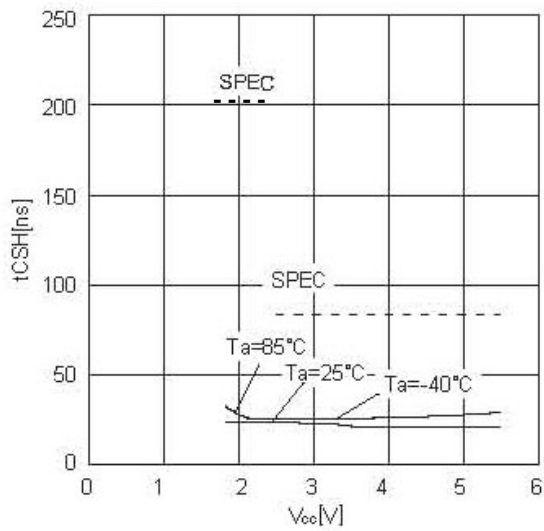

Figure 20. CS hold time t_{CSH}

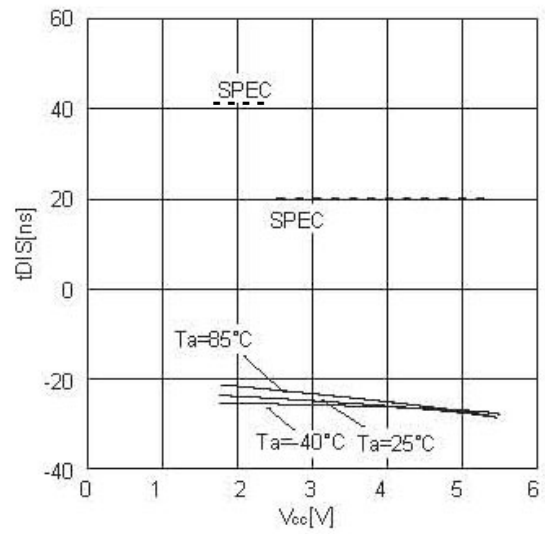

Figure 21. SI setup time t_{DIS}

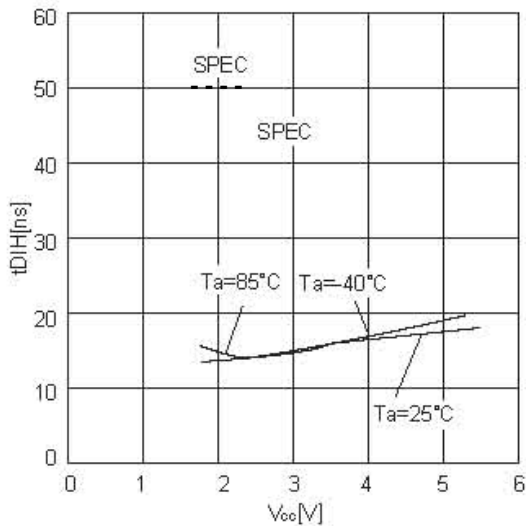

Figure 22. SI hold time t_{DIH}

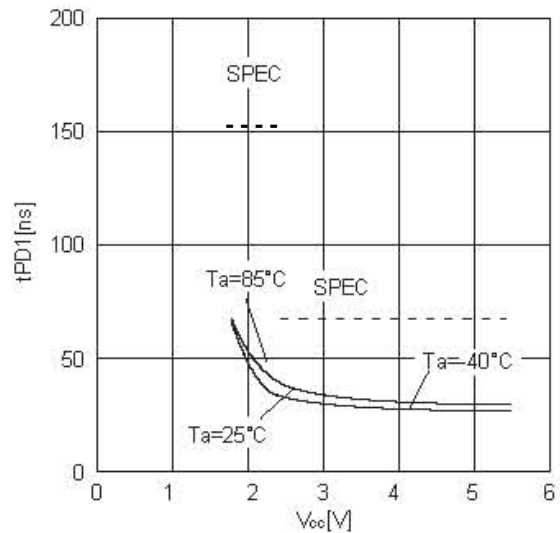

Figure 23. Data output delay time $t_{PD1}(CL=100pF)$

● Typical Performance Curves - Continued

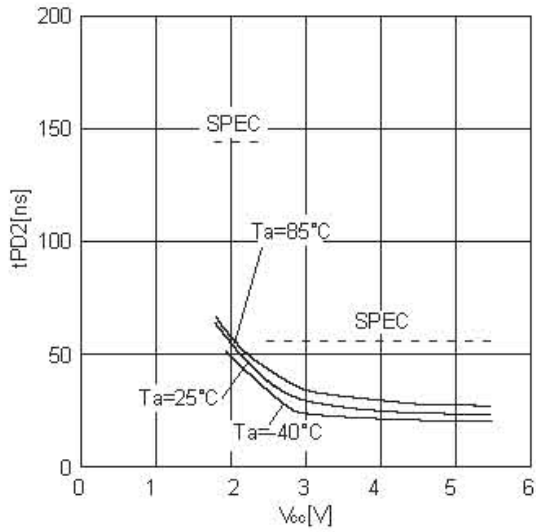

Figure 24. Data output delay time $t_{PD2}(CL=30pF)$

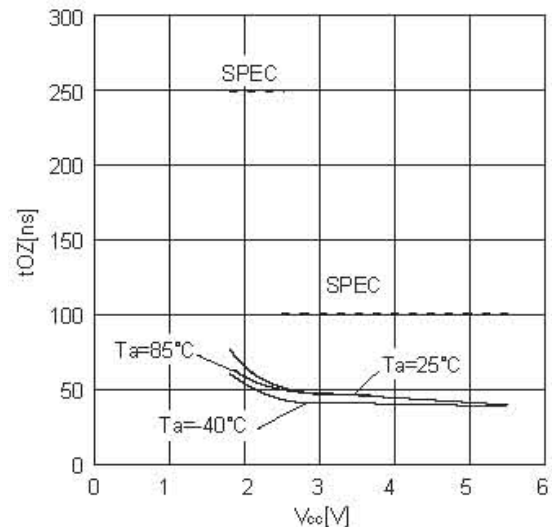

Figure 25. Output disable time t_{OZ}

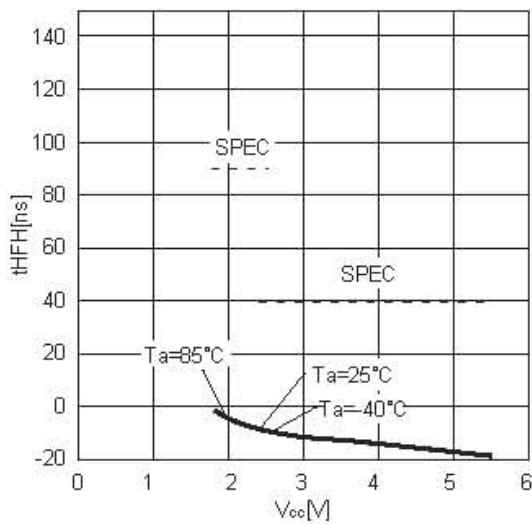

Figure 26. $\overline{\text{HOLD}}$ setting hold time t_{HFH}

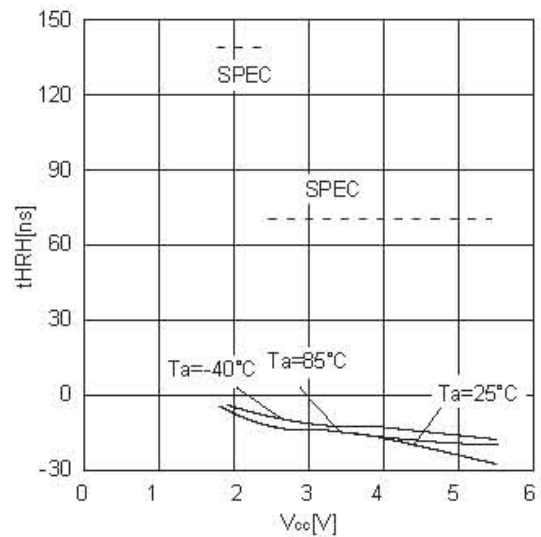

Figure 27. $\overline{\text{HOLD}}$ release hold time t_{HRH}

● Typical Performance Curves - Continued

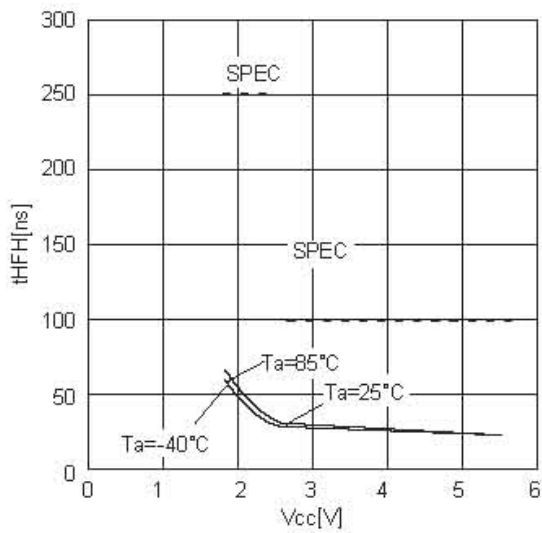

Figure 28. Time from $\overline{\text{HOLD}}$ to output High-Z tHOZ

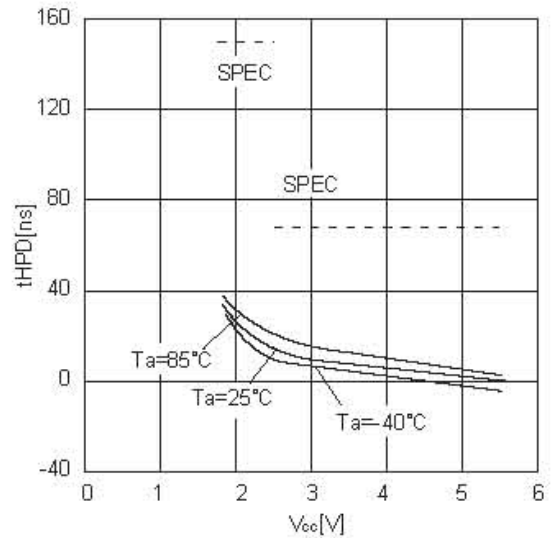

Figure 29. Time from $\overline{\text{HOLD}}$ to output change tHPO

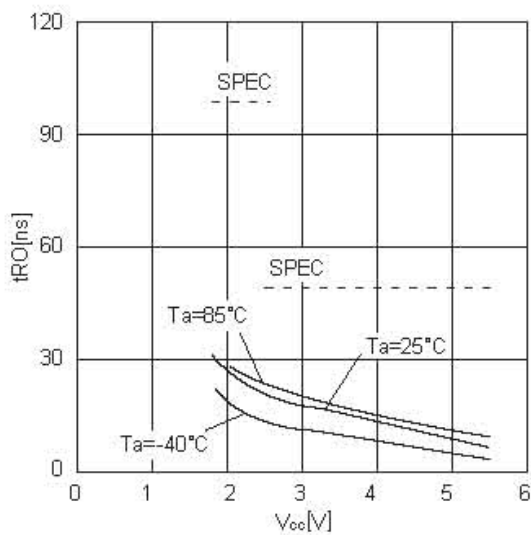

Figure 30. Output rise time tRO

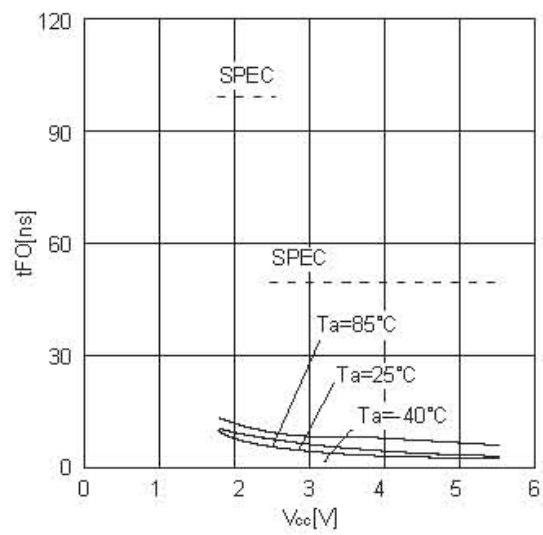

Figure 31. Output fall time

● Typical Performance Curves - Continued

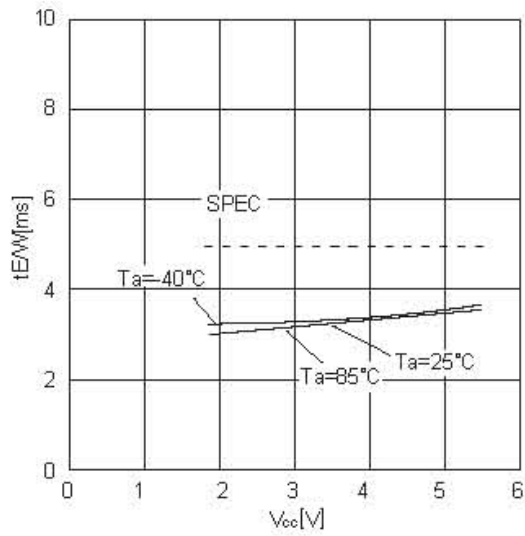

Figure 32. Write cycle time tE/W

●Features

○Status registers

This IC has status registers. The status registers are of 8 bits and express the following parameters.

BP0 and BP1 can be set by write status register command. These 2 bits are memorized into the EEPROM, therefore are valid even when power source is turned off.

Rewrite characteristics and data hold time are same as characteristics of the EEPROM.

WEN can be set by write enable command and write disable command. WEN becomes write disable status when power source is turned off. R/B is for write confirmation, therefore cannot be set externally.

The value of status register can be read by read status command.

●Status registers

Product number	bit 7	bit 6	bit 5	bit 4	bit 3	bit 2	bit 1	bit 0
BR25L010-W	1	1	1	1	BP1	BP0	WEN	\bar{R}/B
BR25L020-W								
BR25L040-W								
BR25L080-W	WPEN	0	0	0	BP1	BP0	WEN	\bar{R}/B
BR25L160-W								
BR25L320-W								
BR25L640-W								

bit	Memory location	Function	Contents
WPEN	EEPROM	$\bar{W}P$ pin enable / disable designation bit WPEN=0=invalid WPEN=1=valid	This enables / disables the functions of WP pin.
BP1 BP0	EEPROM	EEPROM write disable block designation bit	This designates the write disable area of EEPROM. Write designation areas of product numbers are shown below.
WEN	Register	Write and write status register write enable / disable status confirmation bit WEN=0=prohibited WEN=1=permitted	
\bar{R}/B	Register	Write cycle status (READY / BUSY) status confirmation bit $\bar{R}/B=0=READY$ $\bar{R}/B=1=BUSY$	

●Write disable block setting

BP1	BP0	Write disable block						
		BR25L010-W	BR25L020-W	BR25L040-W	BR25L080-W	BR25L160-W	BR25L320-W	BR25L640-W
0	0	None	None	None	None	None	None	None
0	1	60h-7Fh	C0h-FFh	180h-1FFh	300h-3FFh	600h-7FFh	C00h-FFFh	1800h-1FFFh
1	0	40h-7Fh	80h-FFh	100h-1FFh	200h-3FFh	400h-7FFh	800h-FFFh	1000h-1FFFh
1	1	00h-7Fh	00h-FFh	000h-1FFh	000h-3FFh	000h-7FFh	000h-FFFh	0000h-1FFFh

○ $\bar{W}P$ pin

By setting $\bar{W}P=LOW$, write command is prohibited. As for BR25L080, 160, 320, 640-W, only when WPEN bit is set "1", the $\bar{W}P$ pin functions become valid. And the write command to be disabled at this moment is WRSR. As for BR25L010, 020, 040-W, both WRITE and WRSR commands are prohibited.

However, when write cycle is in execution, no interruption can be made.

Product number	WRSR	WRITE
BR25L010-W	Prohibition possible	Prohibition possible
BR25L020-W		
BR25L040-W		
BR25L080-W	Prohibition possible but WPEN bit "1"	Prohibition impossible
BR25L160-W		
BR25L320-W		
BR25L640-W		

○ $\bar{H}OLD$ pin

By $\bar{H}OLD$ pin, data transfer can be interrupted. When $SCK="1"$, by making $\bar{H}OLD$ from "1" into "0", data transfer to EEPROM is interrupted. When $SCK="0"$, by making $\bar{H}OLD$ from "0" into "1", data transfer is restarted.

●Command mode

Command		Contents	Ope code					
			BR25L010-W BR25L020-W		BR25L040-W		BR25L080-W BR25L160-W BR25L320-W BR25L640-W	
WREN	Write enable	Write enable command	0000	* 110	0000	* 110	0000	0110
WRDI	Write disable	Write disable command	0000	* 100	0000	* 100	0000	0100
READ	Read	Read command	0000	* 011	0000	A8011	0000	0011
WRITE	Write	Write command	0000	* 010	0000	A8010	0000	0010
RDSR	Read status register	Status register read command	0000	* 101	0000	* 101	0000	0101
WRSR	Write status register	Status register write command	0000	* 001	0000	* 001	0000	0001

●Timing chart

1. Write enable (WREN) / disable (WRDI) cycle

WREN (WRITE ENABLE): Write enable

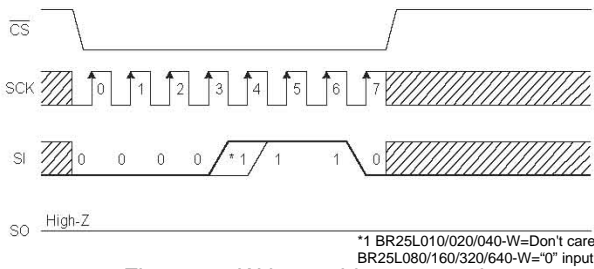

Figure 33. Write enable command

WRDI (WRITE DISABLE): Write disable

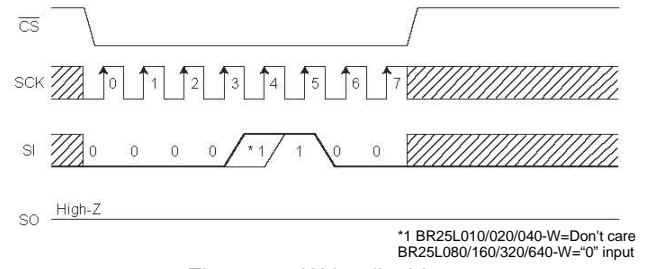

Figure 34. Write disable

○This IC has write enable status and write disable status. It is set to write enable status by write enable command, and it is set to write disable status by write disable command. As for these commands, set CS LOW, and then input the respective ope codes. The respective commands accept command at the 7-th clock rise. Even with input over 7 clocks, command becomes valid. When to carry out write and write status register command, it is necessary to set write enable status by the write enable command. If write or write status register command is input in the write disable status, commands are cancelled. And even in the write enable status, once write and write status register command is executed once, it gets in the write disable status. After power on, this IC is in write disable status.

2. Read command (READ)

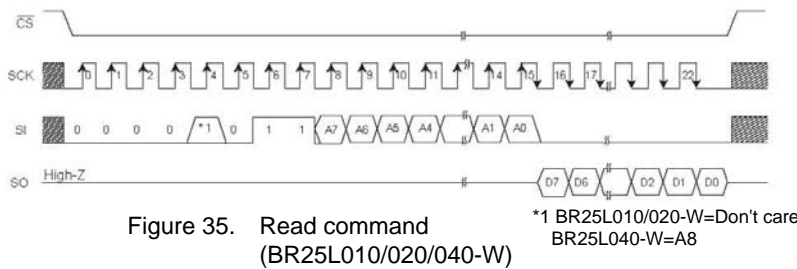

Figure 35. Read command (BR25L010/020/040-W)

Product number	Address length
BR25L010-W	A6-A0
BR25L020-W	A7-A0
BR25L040-W	A8-A0

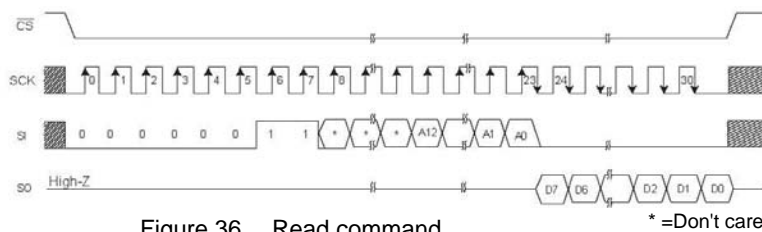

Figure 36. Read command (BR25L080/160/320/640-W)

Product number	Address length
BR25L080-W	A9-A0
BR25L160-W	A10-A0
BR25L320-W	A11-A0
BR25L640-W	A12-A0

By read command, data of EEPROM can be read. As for this command, set CS LOW, then input address after read ope code. EEPROM starts data output of the designated address. Data output is started from SCK fall of 15/23^{*1} clock, and from D7 to D0 sequentially. This IC has increment read function. After output of data for 1 byte (8 bits), by continuing input of SCK, data of the next address can be read. Increment read can read all the addresses of EEPROM. After reading data of the most significant address, by continuing increment read, data of the most insignificant address is read.

*1 BR25L010/020/040-W=15 clocks
BR25L080/160/320/640-W=23 clocks

3. Write command (WRITE)

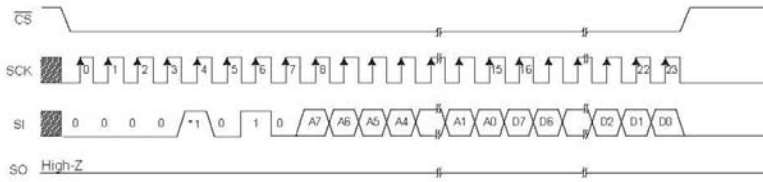

Figure 37. Write command (BR25L010/020/040-W)

*1 BR25L010/020-W=Don't care
BR25L040-W=A8

Product number	Address length
BR25L010-W	A6-A0
BR25L020-W	A7-A0
BR25L040-W	A8-A0

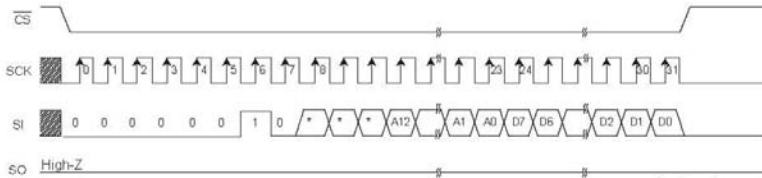

Figure 38. Write command (BR25L080/160/320/640-W)

* =Don't care

Product number	Address length
BR25L080-W	A9-A0
BR25L160-W	A10-A0
BR25L320-W	A11-A0
BR25L640-W	A12-A0

By write command, data of EEPROM can be written. As for this command, set CS LOW, then input address and data after write ope code. Then, by making CS HIGH, the EEPROM starts writing. The write time of EEPROM requires time of tE/W (Max 5ms). During tE/W, other than status read command is not accepted. Start CS after taking the last data (D0), and before the next SCL clock starts. At other timing, write command is not executed, and this write command is cancelled. This IC has page write function, and after input of data for 1 byte (8 bits), by continuing data input without starting CS, data up to 16/32-1 bytes can be written for one tE/W. In page write, the insignificant 4/5-2 bit of the designated address is incremented internally at every time when data of 1 byte is input, and data is written to respective addresses. When data of the maximum bytes or higher is input, address rolls over, and previously input data is overwritten.

*1 BR25L010/020/040-W=16 bytes at maximum
BR25L080/160/320/640-W=32 bytes at maximum

*2 BR25L010/020/040-W=Insignificant 4 bits
BR25L080/160/320/640-W=Insignificant 5 bits

4. Status register write / read command

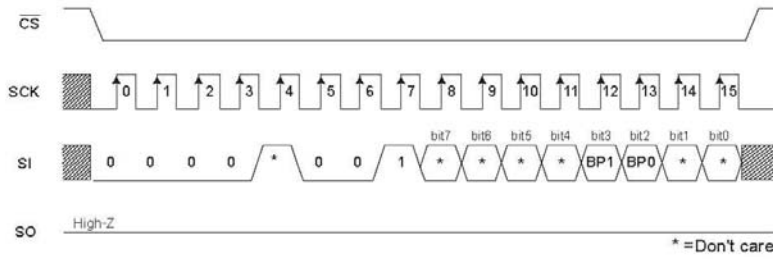

Figure 39. Status register write command (BR25L010/020/040-W)

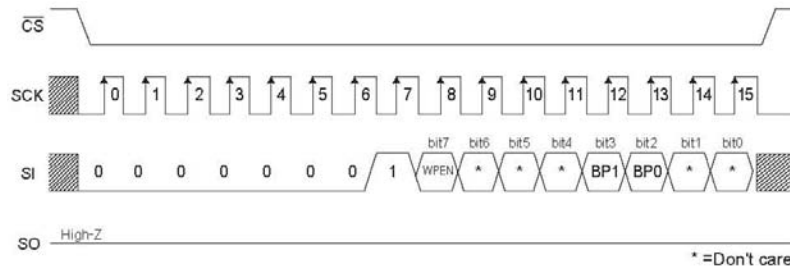

Figure 40. Status register write command (BR25L080/160/320/640-W)

Write status register command can write status register data. The data that can be written by this command are 2 bits *1, that is, BP1 (bit3) and BP0 (bit2) among 8 bits of status register. By BP1 and BP0, write disable block of EEPROM can be set. As for this command, set \overline{CS} LOW, and input opcode of write status register, and input data. Then, by making \overline{CS} HIGH, EEPROM starts writing. Write time requires time of $t_{E/W}$ as same as write. As for \overline{CS} rise, start \overline{CS} after taking the last data bit (bit0), and before the next SCK clock starts. At other timing, command is cancelled. Write disable block is determined by BP1 and BP0, and the block can be selected from 1/4 of memory array, 1/2, and entire memory array. (Refer to the write disable block setting table.) To the write disabled block, write cannot be made, and only read can be made.

* 3 bits including BR25L080, 160, 320, 640-W WPEN (bit7)

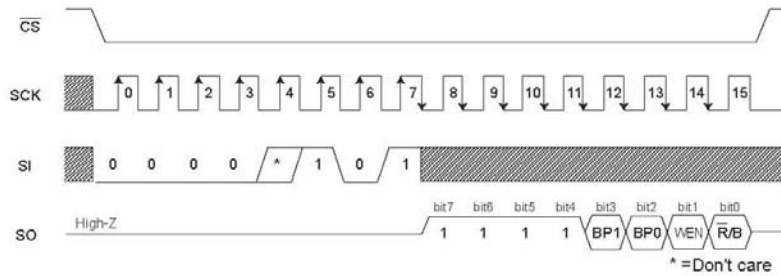

Figure 41. Status register read command (BR25L010/020/040-W)

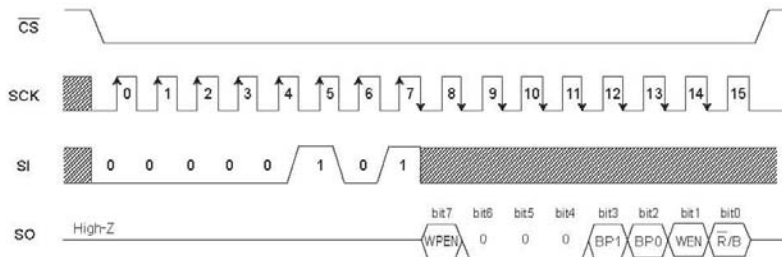

Figure 42. Status register read command (BR25L080/160/320/640-W)

● **At standby**

- Current at standby

Set \overline{CS} "H", and be sure to set SCK, SI, \overline{WP} , \overline{HOLD} input "L" or "H". Do not input intermediate electric potential.

- Timing

As shown in Figure 43, at standby, when SCK is "H", even if \overline{CS} is fallen, SI status is not read at fall edge. SI status is read at SCK rise edge after fall of \overline{CS} . At standby and at power ON/OFF, set \overline{CS} "H" status.

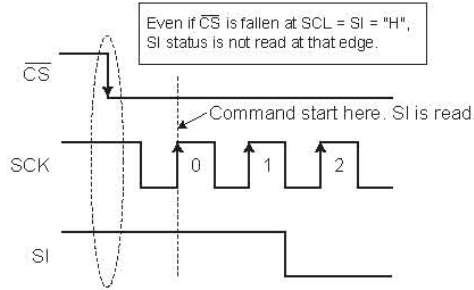

Figure 43. Operating timing

● **\overline{WP} cancel valid area**

\overline{WP} is normally fixed to "H" or "L" for use, but when \overline{WP} is controlled so as to cancel write status register command and write command, pay attention to the following \overline{WP} valid timing.

While write or write status register command is executed, by setting \overline{WP} = "L" in cancel valid area, command can be cancelled. The area from command ope code before \overline{CS} rise at internal automatic write start becomes the cancel valid area. However, once write is started, any input cannot be cancelled. \overline{WP} input becomes Don't Care, and cancellation becomes invalid.

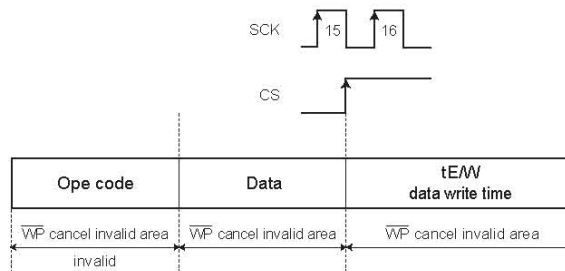

Figure 44. \overline{WP} valid timing (WRSR)

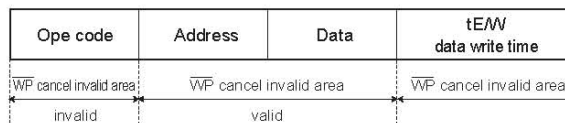

Figure 45. \overline{WP} valid timing (WRITE)

● **HOLD pin**

By HOLD pin, command communication can be stopped temporarily. (HOLD status) The HOLD pin carries out command communications normally when it is HIGH. To get in HOLD status, at command communication, when SCK = LOW, set the HOLD pin LOW. At HOLD status, SCK and SI become Don't Care, and SO becomes high impedance (High-Z). To release the HOLD status, set the HOLD pin HIGH when SCK = LOW. After that, communication can be restarted from the point before the HOLD status. For example, when HOLD status is made after A5 address input at read, after release of HOLD status, by starting A4 address input, read can be restarted. When in HOLD status, leave \overline{CS} LOW. When it is set \overline{CS} = HIGH in HOLD status, the IC is reset, therefore communication after that cannot be restarted.

●Method to cancel each command

OREAD, RDSR

• Method to cancel : cancel by $\overline{CS} = "H"$.

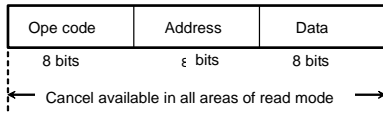

Figure 46. READ cancel valid timing

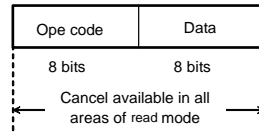

Figure 47. RDSR cancel valid timing

OWRITE, PAGE WRITE

a : Ope code, address input area.

Cancellation is available by $\overline{CS} = "H"$.

b : Data input area (D7 to D1 input area)

Cancellation is available by $\overline{CS} = "H"$.

c : Data input area (D0 area)

When \overline{CS} is started, write starts.

After \overline{CS} rise, cancellation cannot be made by any means.

d : tE/W area

Cancellation is available by $\overline{CS} = "H"$. However, when write starts (\overline{CS} is started) in the area c, cancellation cannot be made by any means. And, by inputting on SCK clock, cancellation cannot be made. In page write mode, there is write enable area at every 8 clocks.

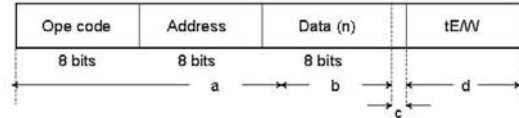
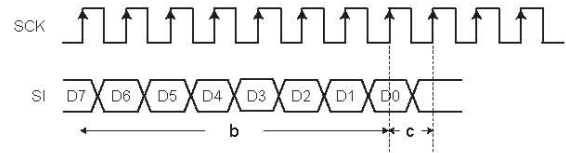

Figure 48. WRITE cancel valid timing



Note1) If V_{cc} is made OFF during write execution, designated address data is not guaranteed, therefore write it once again.
 Note2) If \overline{CS} is started at the same timing as that of the SCK rise, write execution / cancel becomes unstable, therefore, it is recommended to fall in SCK = "L" area. As for SCK rise, assure timing of tCSS / tCSH or higher.

OWRSR

a : From ope code to 15 clock rise

Cancel by $\overline{CS} = "H"$.

b : From 15 clock rise to 16 clock rise (write enable area)

When \overline{CS} is started, write starts.

After \overline{CS} rise, cancellation cannot be made by any means.

c : After 16 clock rise.

Cancel by $\overline{CS} = "H"$. However, when write starts (\overline{CS} is started) in the area b, cancellation cannot be made by any means. And, by inputting on SCK clock, cancellation cannot be made.

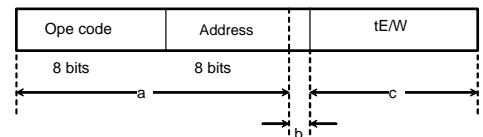
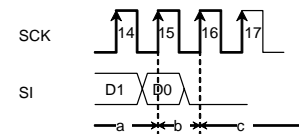

Figure 49. WRSR cancel valid timing

Note1) If V_{cc} is made OFF during write execution, designated address data is not guaranteed, therefore write it once again.

Note2) If \overline{CS} is started at the same timing as that of the SCK rise, write execution / cancel becomes unstable, therefore, it is recommended to fall in SCK = "L" area. As for SCK rise, assure timing of tCSS/tCSH or higher.

OWREN/WRDI

a : From ope code to clock rise, cancel by $\overline{CS} = "H"$.

b : Cancellation is not available when \overline{CS} is started after 7 clock.

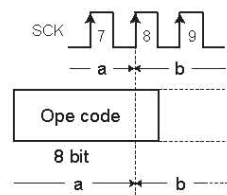

Figure 50. WREN/WRDI cancel valid timing

●High speed operation

In order to realize stable high speed operations, pay attention to the following input / output pin conditions.

○Input pin pull up, pull down resistance

When to attach pull up, pull down resistance to EEPROM input pin, select an appropriate value for the microcontroller VOL, IOL from VIL characteristics of this IC.

○Pull up resistance

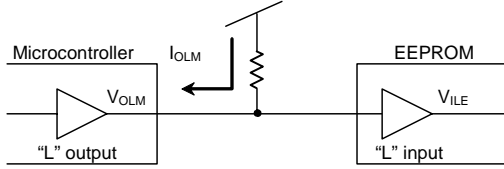

Figure 51. Pull up resistance

$$R_{PU} \geq \frac{V_{CC} - V_{OLM}}{I_{OLM}} \quad \dots \textcircled{1}$$

$$V_{OLM} \leq V_{ILE} \quad \dots \textcircled{2}$$

Example) When $V_{CC}=5V$, $V_{ILM}=1.5V$, $V_{OLM}=0.4V$, $I_{OLM}=2mA$, from the equation ①,

$$R_{PU} \geq \frac{5 - 0.4}{2 \times 10^{-3}}$$

$$\therefore R_{PU} \geq 2.3[k\Omega]$$

With the value of R_{pu} to satisfy the above equation, V_{OLM} becomes 0.4V or higher, and with $V_{ILE} (=1.5V)$, the equation ② is also satisfied.

- V_{ILM} :EEPROM V_{IH} specifications
- V_{OLM} :Microcontroller V_{OL} specifications
- I_{OLM} :Microcontroller I_{OL} specifications

And, in order to prevent malfunction, mistake write at power ON/OFF, be sure to make \overline{CS} pull up.

○Pull down resistance

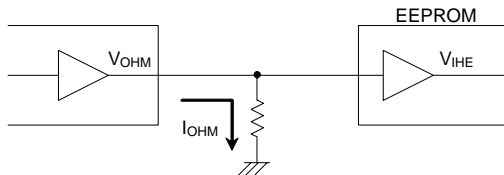

Figure 52. Pull down resistance

$$R_{PD} \geq \frac{V_{OHM}}{I_{OHM}} \quad \dots \textcircled{3}$$

$$V_{OHM} \geq V_{IHE} \quad \dots \textcircled{4}$$

Example) When $V_{CC}=5V$, $V_{OHM}=V_{CC}-0.5V$, $I_{OHM}=0.4mA$, $V_{IHM}=V_{CC} \times 0.7V$, from the equation ③,

$$R_{PD} \geq \frac{5 - 0.5}{0.4 \times 10^{-3}}$$

$$\therefore R_{PD} \geq 11.3[k\Omega]$$

Further, by amplitude V_{IHE} , V_{ILE} of signal input to EEPROM, operation speed changes. By inputting signal of amplitude of V_{CC} / GND level to input, more stable high speed operations can be realized. On the contrary, when amplitude of $0.8V_{CC} / 0.2V_{CC}$ is input, operation speed becomes slow.

In order to realize more stable high speed operation, it is recommended to make the values of R_{PU} , R_{PD} as large as possible, and make the amplitude of signal input to EEPROM close to the amplitude of V_{CC} / GND level.

(*1 At this moment, operating timing guaranteed value is guaranteed.)

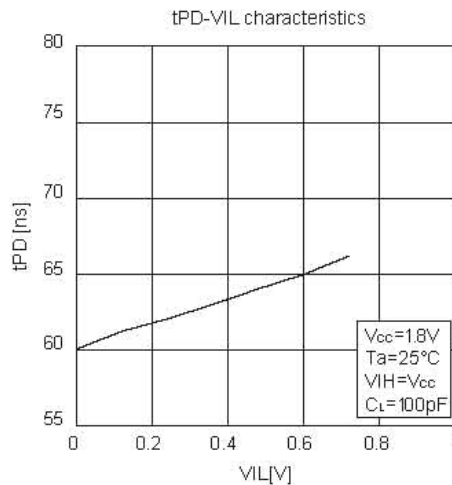
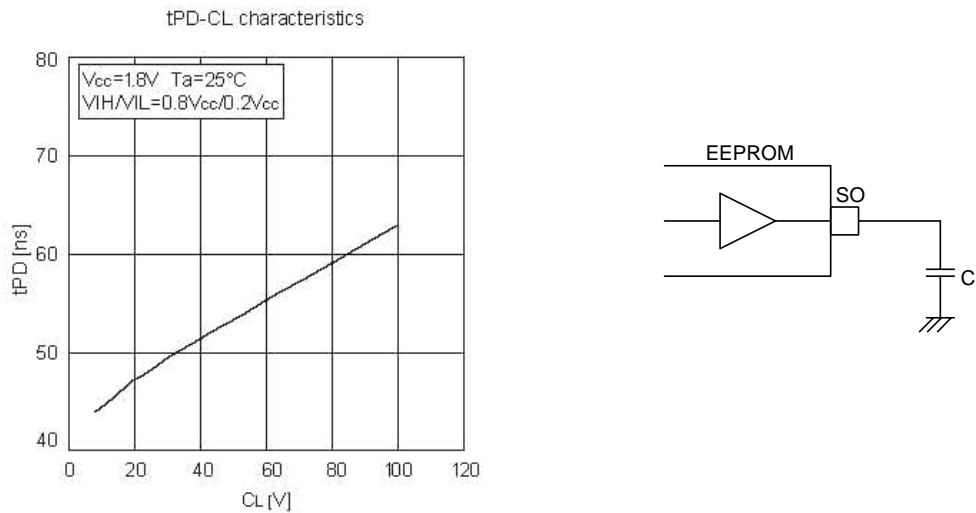

Figure 53. VIL dependency of data output delay time

OSO load capacity condition

Load capacity of SO output pin affects upon delay characteristic of SO output. (Data output delay time, time from $\overline{\text{HOLD}}$ to High-Z) In order to make output delay characteristic into higher speed, make SO load capacity small. In concrete, "Do not connect many devices to SO bus", "Make the wire between the controller and EEPROM short", and so forth.



Other cautions

Make the wire length from the microcontroller to EEPROM input signal same length, in order to prevent setup / hold violation to EEPROM, owing to difference of wire length of each input.

●Equivalent circuit

○Output circuit

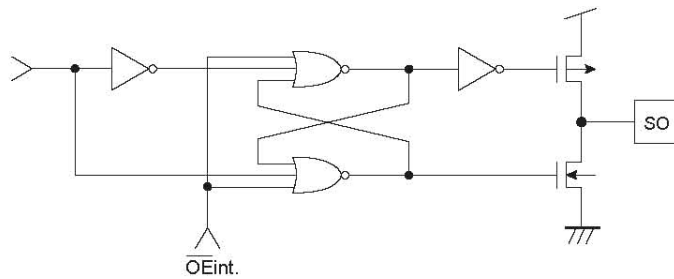

Figure 55. SO output equivalent circuit

○Input circuit

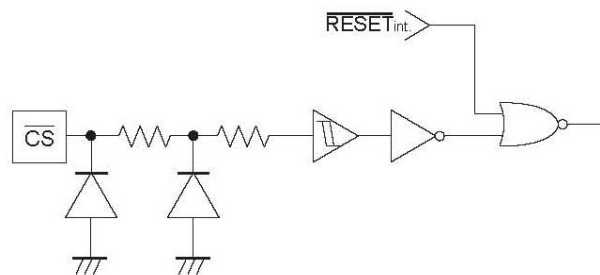

Figure 56. CS input equivalent circuit

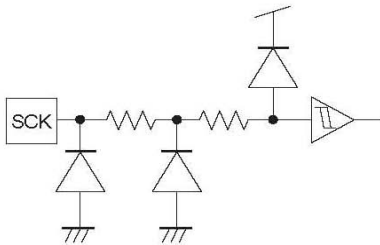

Figure 57. SCK input equivalent circuit

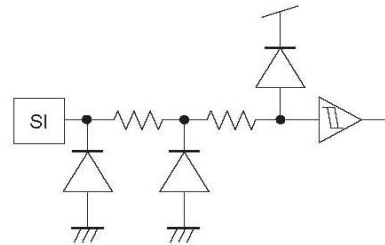

Figure 58. SI input equivalent circuit

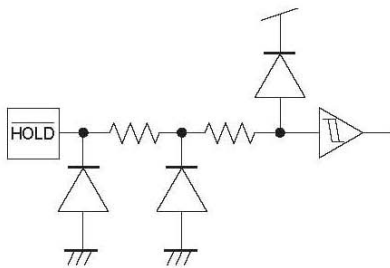

Figure 59. HOLD input equivalent circuit

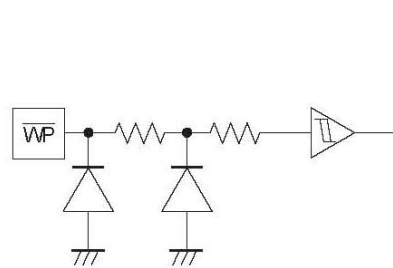

Figure 60. WP input equivalent circuit

●Notes on power ON/OFF

○At power ON/OFF, set CS "H" (= Vcc).

When CS is "L", this IC gets in input accept status (active). If power is turned on in this status, noises and the likes may cause malfunction, mistake write or so. To prevent these, at power ON, set CS "H". (When CS is in "H" status, all inputs are canceled.)

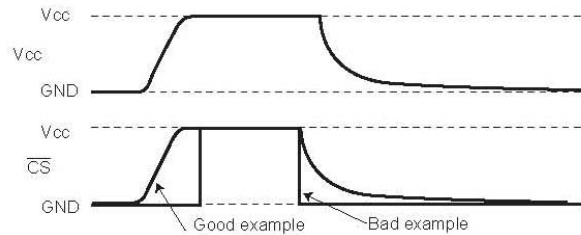

Figure 61. CS timing at power ON/OFF

(Good example) CS terminal is pulled up to Vcc.

At power OFF, take 10ms or higher before re supply. If power is turned on without observing this condition, the IC internal circuit may not be reset, which please note.

(Bad example) CS terminal is "L" at power ON/OFF.

In this case, CS always becomes "L" (active status), and EEPROM may have malfunction, mistake write owing to noises and the likes.

Even when CS input is High-Z, the status becomes like this case, which please note.

OPOR circuit

This IC has a POR (Power On Reset) circuit as mistake write countermeasure. After POR action, it gets in write disable status. The POR circuit is valid only when power is ON, and does not work when power is OFF. When power is ON, if the recommended conditions of the following t_R , t_{OFF} , and V_{bot} are not satisfied, it may become write enable status owing to noises and the likes.

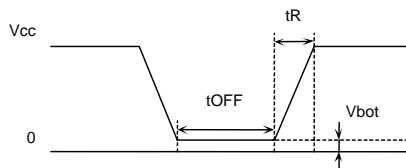

Figure 62. Rise waveform

Recommended conditions of t_R , t_{OFF} , V_{bot}

t_R	t_{OFF}	V_{bot}
10ms or below	10ms or higher	0.3V or below
100ms or below	10ms or higher	0.2V or below

●Noise countermeasures

○Vcc noise (bypass capacitor)

When noise or surge gets in the power source line, malfunction may occur, therefore, for removing these, it is recommended to attach a by pass capacitor (0.1 μ F) between IC Vcc and GND. At that moment, attach it as close to IC as possible.

And, it is also recommended to attach a bypass capacitor between board Vcc and GND.

○SCK noise

When the rise time (t_R) of SCK is long, and a certain degree or more of noise exists, malfunction may occur owing to clock bit displacement.

To avoid this, a Schmitt trigger circuit is built in SCK input. The hysteresis width of this circuit is set about 0.2V, if noises exist at SCK input, set the noise amplitude 0.2Vp-p or below. And it is recommended to set the rise time (t_R) of SCK 100ns or below. In the case when the rise time is 100ns or higher, take sufficient noise countermeasures. Make the clock rise, fall time as small as possible.

○WP noise

During execution of write status register command, if there exist noises on WP pin, mistake in recognition may occur and forcible cancellation may result, which please note. To avoid this, a Schmitt trigger circuit is built in WP input. In the same manner, a Schmitt trigger circuit is built in SI input and HOLD input too.

●Cautions on use

- (1) Described numeric values and data are design representative values, and the values are not guaranteed.
- (2) We believe that application circuit examples are recommendable, however, in actual use, confirm characteristics further sufficiently. In the case of use by changing the fixed number of external parts, make your decision with sufficient margin in consideration of static characteristics and transition characteristics and fluctuations of external parts and our LSI.
- (3) Absolute maximum ratings
If the absolute maximum ratings such as impressed voltage and operating temperature range and so forth are exceeded, LSI may be destructed.
Do not impress voltage and temperature exceeding the absolute maximum ratings. In the case of fear exceeding the absolute maximum ratings, take physical safety countermeasures such as fuses, and see to it that conditions exceeding the absolute maximum ratings should not be impressed to LSI.
- (4) GND electric potential
Set the voltage of GND terminal lowest at any action condition. Make sure that each terminal voltage is lower than that of GND terminal.
- (5) Heat design
In consideration of permissible dissipation in actual use condition, carry out heat design with sufficient margin.
- (6) Terminal to terminal short circuit and wrong packaging
When to package LSI onto a board, pay sufficient attention to LSI direction and displacement. Wrong packaging may destruct LSI. And in the case of short circuit between LSI terminals and terminals and power source, terminal and GND owing to foreign matter, LSI may be destructed.
- (7) Use in a strong electromagnetic field may cause malfunction, therefore, evaluate design sufficiently.

● Ordering Information

Product Code Description

B R 2 5 L x x x x x x - W	x x
---------------------------	-----

BUS type

25 : SPI

Operating temperature

-40°C to+85°C

Capacity

010=1K 080=8K 640=64K

020=2K 160=16K

040=4K 320=32K

Package

Blank : DIP-T8

F : SOP8

FJ : SOP-J8

FV : SSOP-B8

FVT : TSSOP-B8

FVJ : TSSOP-B8J

FVM : MSOP8

Double Cell

Package specifications

E2 : reel shape emboss taping (SOP8,SOP-J8,SSOP-B8,TSSOP-B8,TSSOP-B8J)

TR : reel shape emboss taping (MSOP8)

None : Tube (DIP-T8)

● Lineup

Capacity	Package	
	Type	Quantity
1K	SOP8	Reel of 2500
	SOP-J8	
	SSOP-B8	
	TSSOP-B8J	
	TSSOP-B8	Reel of 3000
	MSOP8	
2K	SOP8	Reel of 2500
	SOP-J8	
	SSOP-B8	
	TSSOP-B8J	
	TSSOP-B8	Reel of 3000
	MSOP8	
4K	DIP-T8	Tube of 2000
	SOP8	Reel of 2500
	SOP-J8	
	SSOP-B8	
	TSSOP-B8J	
	TSSOP-B8	Reel of 3000
	MSOP8	

Capacity	Package	
	Type	Quantity
8K	DIP-T8	Tube of 2000
	SOP8	Reel of 2500
	SOP-J8	
	SSOP-B8	
	TSSOP-B8	Reel of 3000
16K	DIP-T8	Tube of 2000
	SOP8	Reel of 2500
	SOP-J8	
	SSOP-B8	
TSSOP-B8	Reel of 3000	
32K	DIP-T8	Tube of 2000
	SOP8	Reel of 2500
64K	SOP-J8	Reel of 2500
	DIP-T8	Tube of 2000
	SOP8	Reel of 2500

●Physical Dimension Tape and Reel Information

DIP-T8

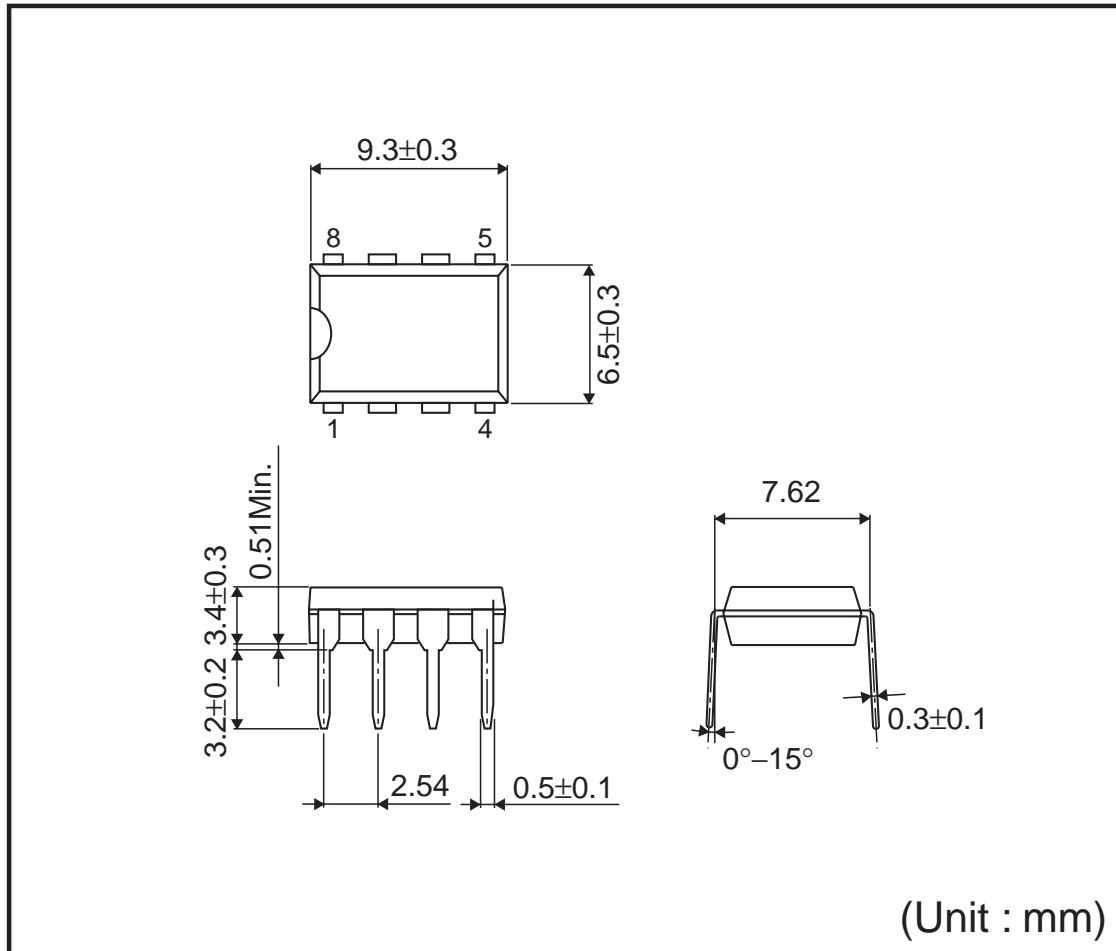

<Tape and Reel information>

Container	Tube
Quantity	2000pcs
Direction of feed	Direction of products is fixed in a container tube

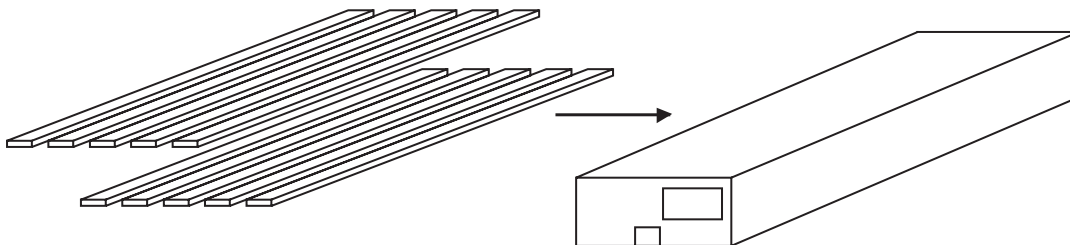

*Order quantity needs to be multiple of the minimum quantity.

●Physical Dimension Tape and Reel Information - continued

SOP8

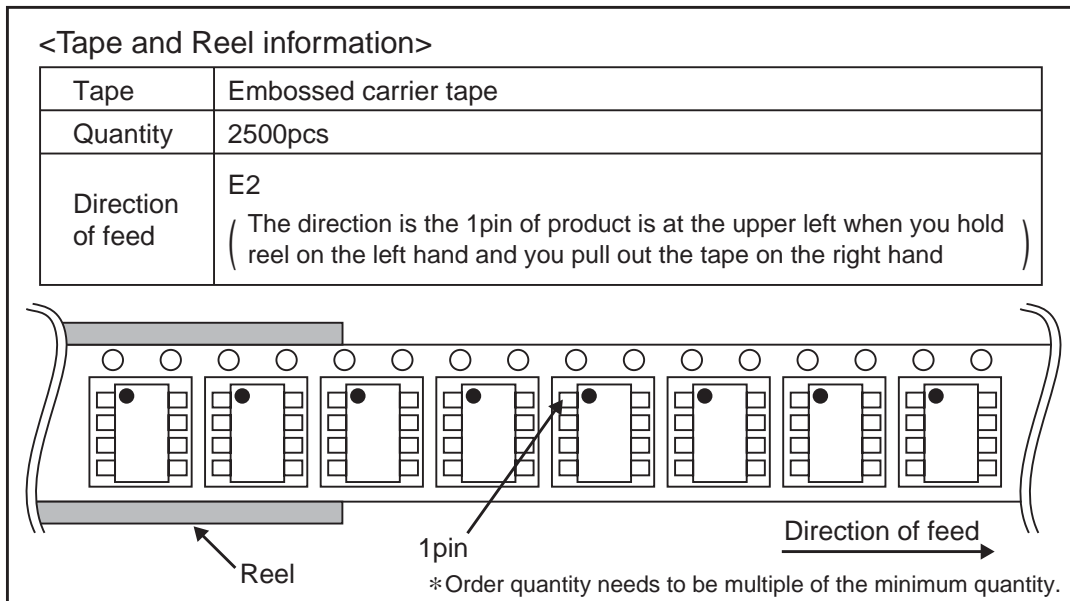
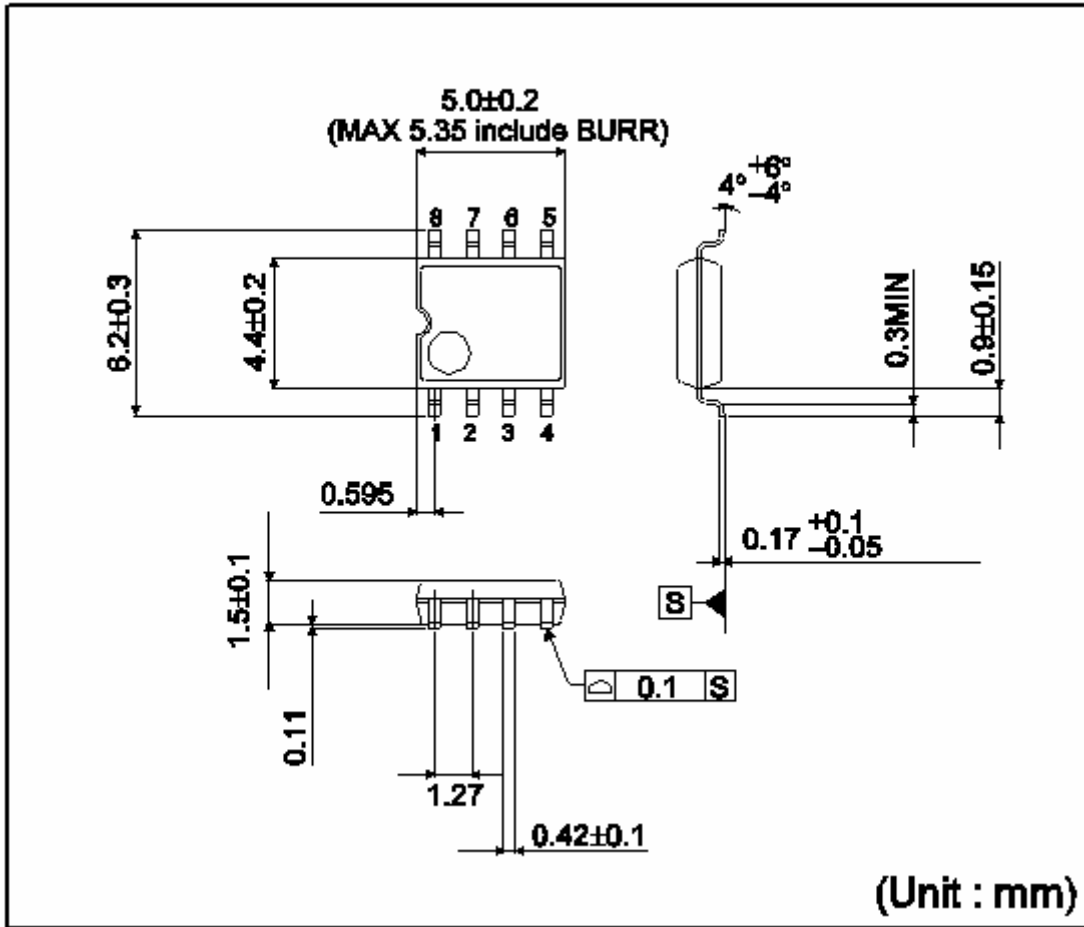

●Physical Dimension Tape and Reel Information - continued

SOP-J8

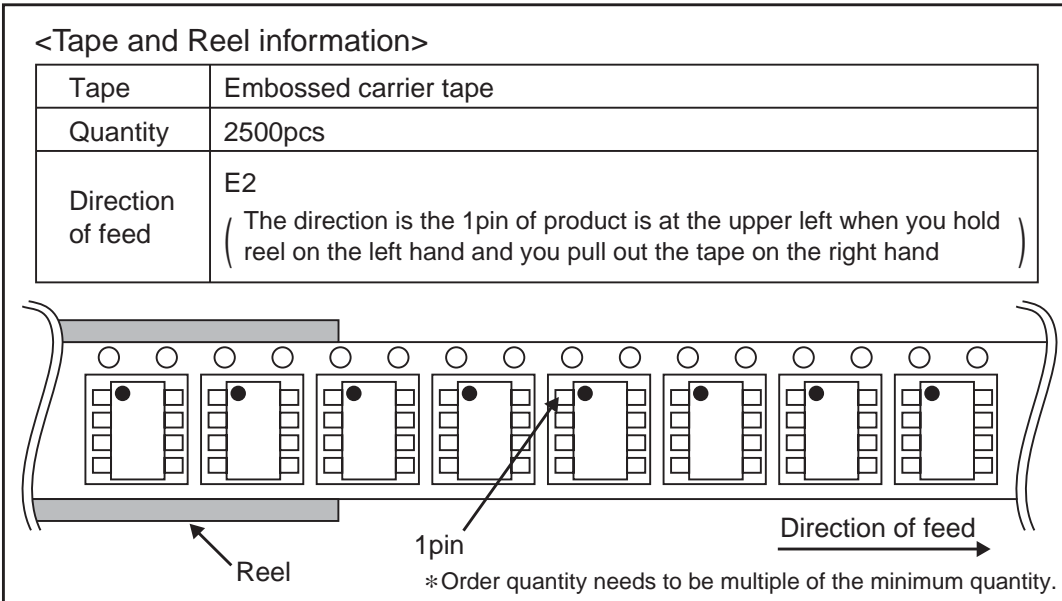
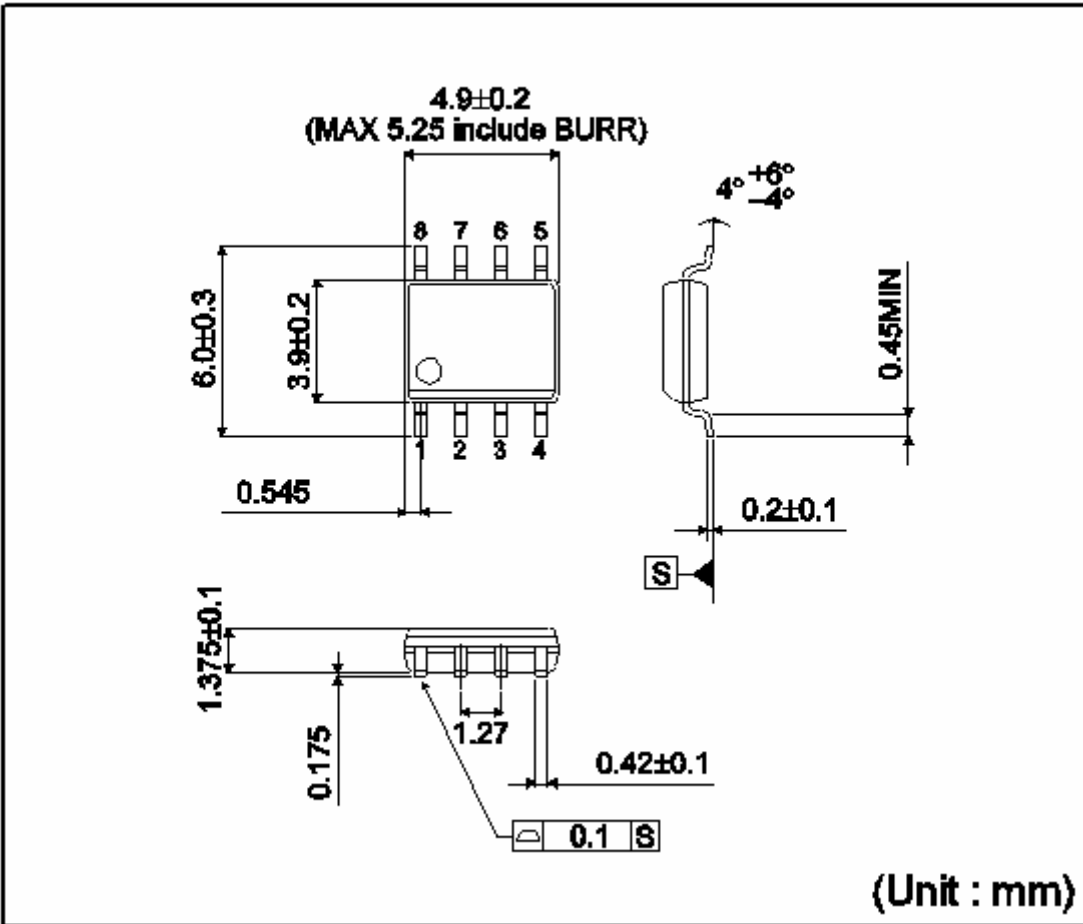

●Physical Dimension Tape and Reel Information - continued

SSOP-B8



<Tape and Reel information>

Tape	Embossed carrier tape
Quantity	2500pcs
Direction of feed	E2 (The direction is the 1pin of product is at the upper left when you hold reel on the left hand and you pull out the tape on the right hand)

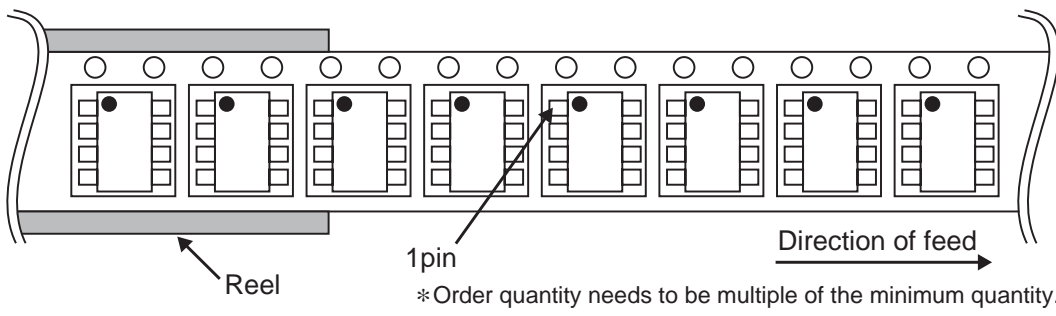

●Physical Dimension Tape and Reel Information - continued

TSSOP-B8

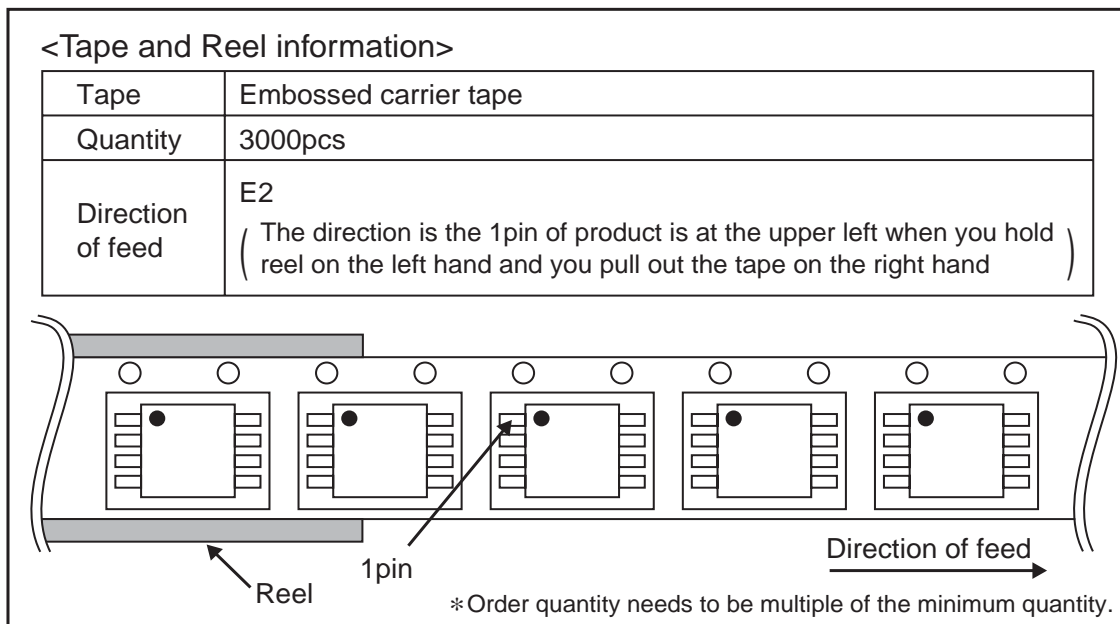
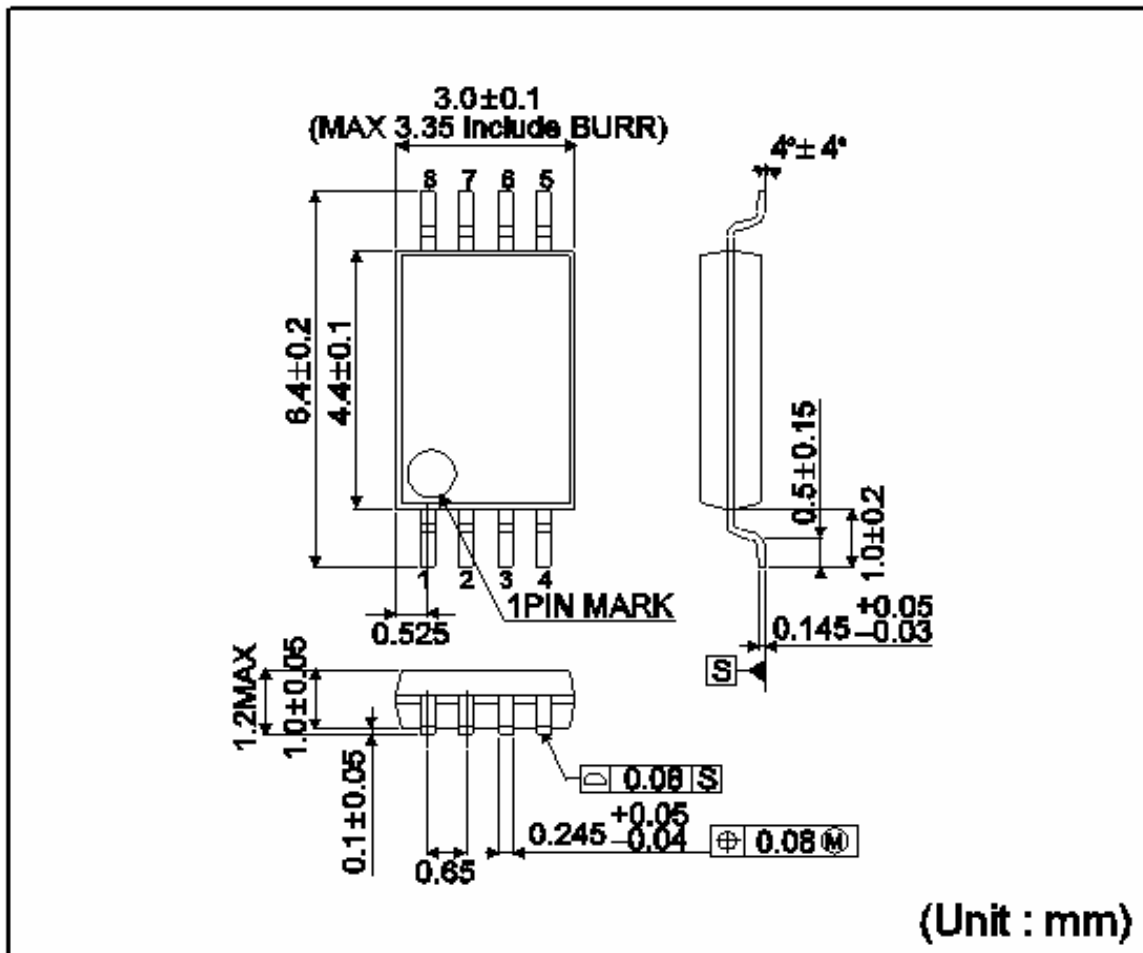

●Physical Dimension Tape and Reel Information - continued

TSSOP-B8J

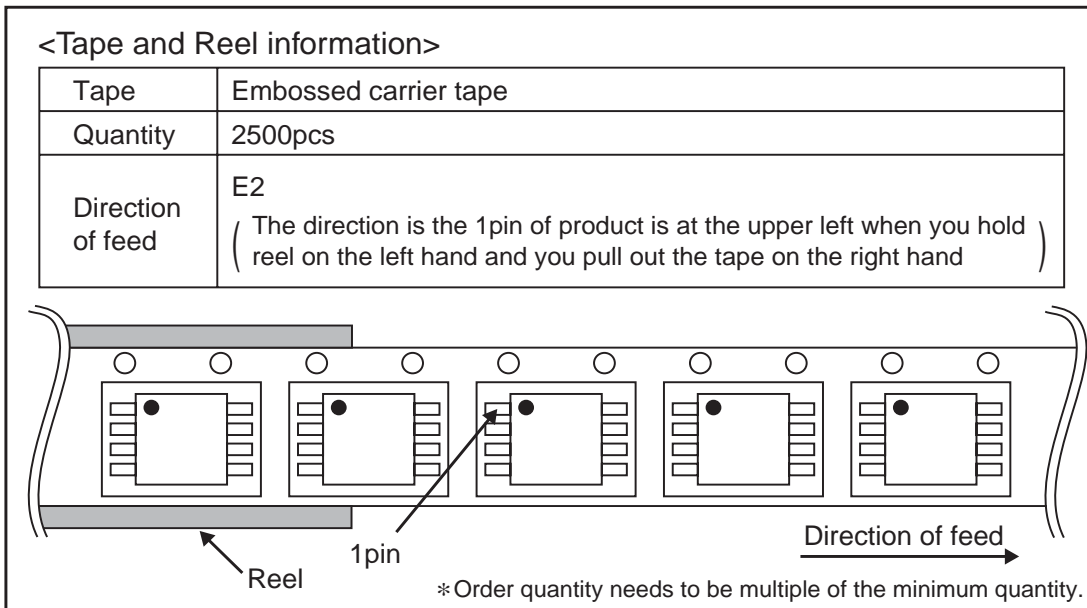
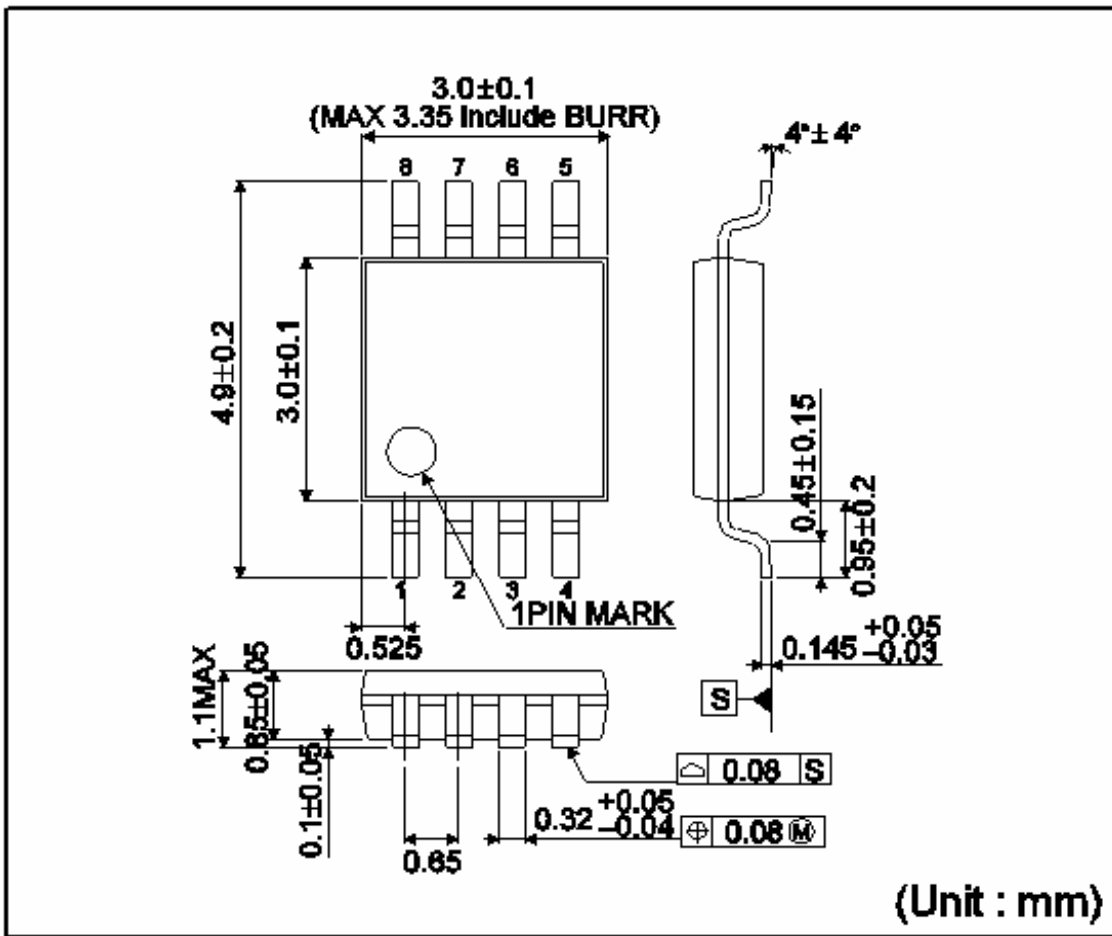

●Physical Dimension Tape and Reel Information - continued

MSOP8

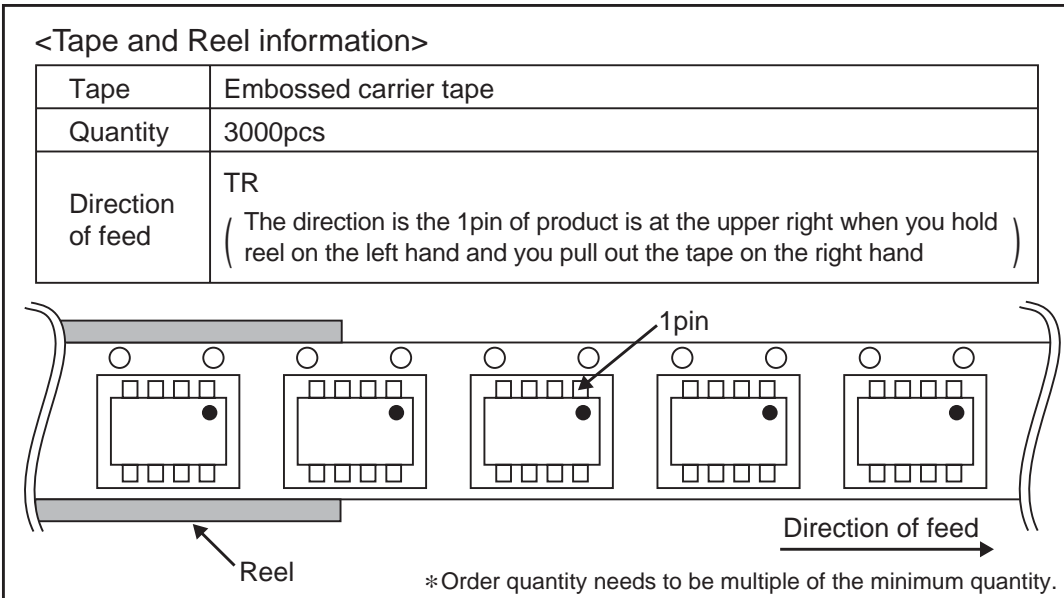

● Marking Diagrams

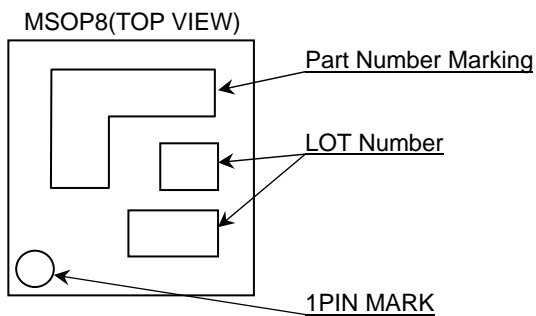
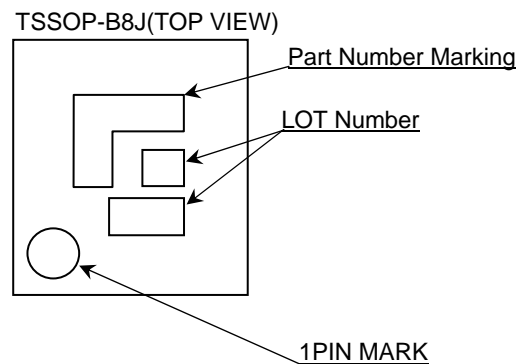
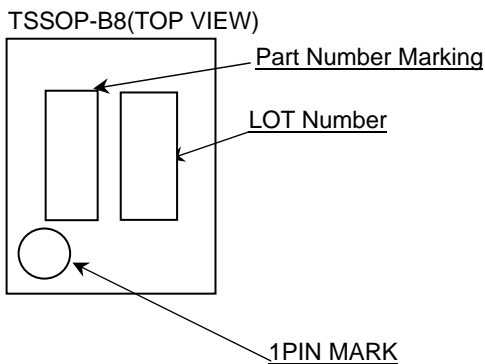
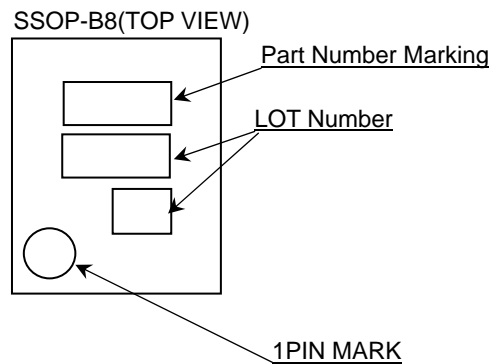
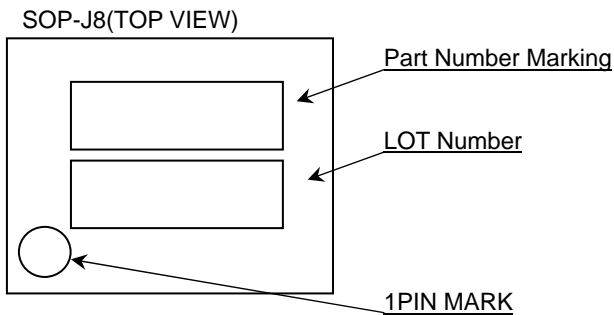
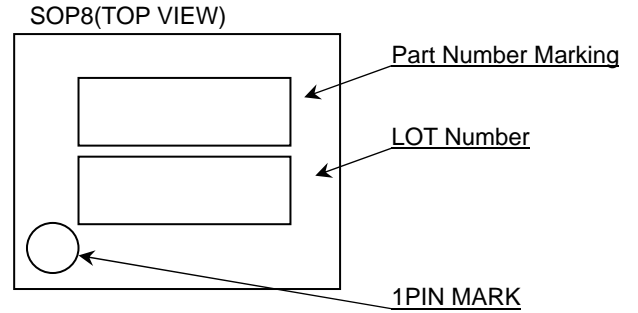
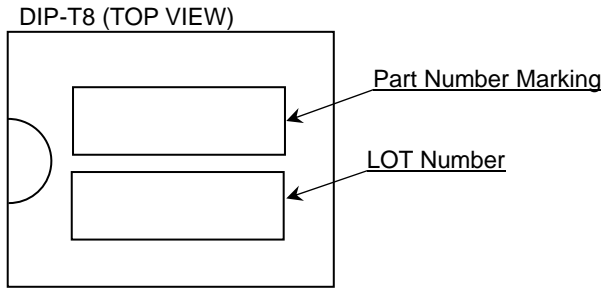

● Marking Information

Capacity	Product Name Marking	Package Type
1K	L010	SOP8
	L010	SOP-J8
	L010	SSOP-B8
	L010	TSSOP-B8J
	L010	TSSOP-B8
	L010	MSOP8
2K	L020	SOP8
	L020	SOP-J8
	L020	SSOP-B8
	L020	TSSOP-B8J
	L020	TSSOP-B8
	L020	MSOP8
4K	BR25L040	DIP-T8
	L040	SOP8
	L040	SOP-J8
	L040	SSOP-B8
	L040	TSSOP-B8J
	L040	TSSOP-B8
	L040	MSOP8

Capacity	Product Name Marking	Package Type
8K	BR25L080	DIP-T8
	L080	SOP8
	L080	SOP-J8
	L080	SSOP-B8
	L080	TSSOP-B8
16K	BR25L160	DIP-T8
	L160	SOP8
	L160	SOP-J8
	L160	SSOP-B8
	L160	TSSOP-B8
32K	BR25L320	DIP-T8
	L320	SOP8
	L320	SOP-J8
64K	BR25L640	DIP-T8
	L640	SOP8
	L640	SOP-J8

●Revision History

Date	Revision	Changes
23.Aug.2012	001	New Release
22.Jan.2013	002	Add DIP-T8 Package (4K,8K,16K,32K,64K)

Notice

Precaution on using ROHM Products

- Our Products are designed and manufactured for application in ordinary electronic equipments (such as AV equipment, OA equipment, telecommunication equipment, home electronic appliances, amusement equipment, etc.). If you intend to use our Products in devices requiring extremely high reliability (such as medical equipment ^(Note 1), transport equipment, traffic equipment, aircraft/spacecraft, nuclear power controllers, fuel controllers, car equipment including car accessories, safety devices, etc.) and whose malfunction or failure may cause loss of human life, bodily injury or serious damage to property ("Specific Applications"), please consult with the ROHM sales representative in advance. Unless otherwise agreed in writing by ROHM in advance, ROHM shall not be in any way responsible or liable for any damages, expenses or losses incurred by you or third parties arising from the use of any ROHM's Products for Specific Applications.

(Note1) Medical Equipment Classification of the Specific Applications

JAPAN	USA	EU	CHINA
CLASS III	CLASS III	CLASS II b	CLASS III
CLASS IV		CLASS III	

- ROHM designs and manufactures its Products subject to strict quality control system. However, semiconductor products can fail or malfunction at a certain rate. Please be sure to implement, at your own responsibilities, adequate safety measures including but not limited to fail-safe design against the physical injury, damage to any property, which a failure or malfunction of our Products may cause. The following are examples of safety measures:
 - Installation of protection circuits or other protective devices to improve system safety
 - Installation of redundant circuits to reduce the impact of single or multiple circuit failure
- Our Products are designed and manufactured for use under standard conditions and not under any special or extraordinary environments or conditions, as exemplified below. Accordingly, ROHM shall not be in any way responsible or liable for any damages, expenses or losses arising from the use of any ROHM's Products under any special or extraordinary environments or conditions. If you intend to use our Products under any special or extraordinary environments or conditions (as exemplified below), your independent verification and confirmation of product performance, reliability, etc. prior to use, must be necessary:
 - Use of our Products in any types of liquid, including water, oils, chemicals, and organic solvents
 - Use of our Products outdoors or in places where the Products are exposed to direct sunlight or dust
 - Use of our Products in places where the Products are exposed to sea wind or corrosive gases, including Cl₂, H₂S, NH₃, SO₂, and NO₂
 - Use of our Products in places where the Products are exposed to static electricity or electromagnetic waves
 - Use of our Products in proximity to heat-producing components, plastic cords, or other flammable items
 - Sealing or coating our Products with resin or other coating materials
 - Use of our Products without cleaning residue of flux (even if you use no-clean type fluxes, cleaning residue of flux is recommended); or Washing our Products by using water or water-soluble cleaning agents for cleaning residue after soldering
 - Use of the Products in places subject to dew condensation
- The Products are not subject to radiation-proof design.
- Please verify and confirm characteristics of the final or mounted products in using the Products.
- In particular, if a transient load (a large amount of load applied in a short period of time, such as pulse. is applied, confirmation of performance characteristics after on-board mounting is strongly recommended. Avoid applying power exceeding normal rated power; exceeding the power rating under steady-state loading condition may negatively affect product performance and reliability.
- De-rate Power Dissipation (Pd) depending on Ambient temperature (Ta). When used in sealed area, confirm the actual ambient temperature.
- Confirm that operation temperature is within the specified range described in the product specification.
- ROHM shall not be in any way responsible or liable for failure induced under deviant condition from what is defined in this document.

Precaution for Mounting / Circuit board design

- When a highly active halogenous (chlorine, bromine, etc.) flux is used, the residue of flux may negatively affect product performance and reliability.
- In principle, the reflow soldering method must be used; if flow soldering method is preferred, please consult with the ROHM representative in advance.

For details, please refer to ROHM Mounting specification

Precautions Regarding Application Examples and External Circuits

1. If change is made to the constant of an external circuit, please allow a sufficient margin considering variations of the characteristics of the Products and external components, including transient characteristics, as well as static characteristics.
2. You agree that application notes, reference designs, and associated data and information contained in this document are presented only as guidance for Products use. Therefore, in case you use such information, you are solely responsible for it and you must exercise your own independent verification and judgment in the use of such information contained in this document. ROHM shall not be in any way responsible or liable for any damages, expenses or losses incurred by you or third parties arising from the use of such information.

Precaution for Electrostatic

This Product is electrostatic sensitive product, which may be damaged due to electrostatic discharge. Please take proper caution in your manufacturing process and storage so that voltage exceeding the Products maximum rating will not be applied to Products. Please take special care under dry condition (e.g. Grounding of human body / equipment / solder iron, isolation from charged objects, setting of ionizer, friction prevention and temperature / humidity control).

Precaution for Storage / Transportation

1. Product performance and soldered connections may deteriorate if the Products are stored in the places where:
 - [a] the Products are exposed to sea winds or corrosive gases, including Cl₂, H₂S, NH₃, SO₂, and NO₂
 - [b] the temperature or humidity exceeds those recommended by ROHM
 - [c] the Products are exposed to direct sunshine or condensation
 - [d] the Products are exposed to high Electrostatic
2. Even under ROHM recommended storage condition, solderability of products out of recommended storage time period may be degraded. It is strongly recommended to confirm solderability before using Products of which storage time is exceeding the recommended storage time period.
3. Store / transport cartons in the correct direction, which is indicated on a carton with a symbol. Otherwise bent leads may occur due to excessive stress applied when dropping of a carton.
4. Use Products within the specified time after opening a humidity barrier bag. Baking is required before using Products of which storage time is exceeding the recommended storage time period.

Precaution for Product Label

QR code printed on ROHM Products label is for ROHM's internal use only.

Precaution for Disposition

When disposing Products please dispose them properly using an authorized industry waste company.

Precaution for Foreign Exchange and Foreign Trade act

Since our Products might fall under controlled goods prescribed by the applicable foreign exchange and foreign trade act, please consult with ROHM representative in case of export.

Precaution Regarding Intellectual Property Rights

1. All information and data including but not limited to application example contained in this document is for reference only. ROHM does not warrant that foregoing information or data will not infringe any intellectual property rights or any other rights of any third party regarding such information or data. ROHM shall not be in any way responsible or liable for infringement of any intellectual property rights or other damages arising from use of such information or data.:
2. No license, expressly or implied, is granted hereby under any intellectual property rights or other rights of ROHM or any third parties with respect to the information contained in this document.

Other Precaution



1. This document may not be reprinted or reproduced, in whole or in part, without prior written consent of ROHM.
2. The Products may not be disassembled, converted, modified, reproduced or otherwise changed without prior written consent of ROHM.
3. In no event shall you use in any way whatsoever the Products and the related technical information contained in the Products or this document for any military purposes, including but not limited to, the development of mass-destruction weapons.
4. The proper names of companies or products described in this document are trademarks or registered trademarks of ROHM, its affiliated companies or third parties.

General Precaution

1. Before you use our Products, you are requested to carefully read this document and fully understand its contents. ROHM shall not be in any way responsible or liable for failure, malfunction or accident arising from the use of any ROHM's Products against warning, caution or note contained in this document.
2. All information contained in this document is current as of the issuing date and subject to change without any prior notice. Before purchasing or using ROHM's Products, please confirm the latest information with a ROHM sales representative.
3. The information contained in this document is provided on an "as is" basis and ROHM does not warrant that all information contained in this document is accurate and/or error-free. ROHM shall not be in any way responsible or liable for any damages, expenses or losses incurred by you or third parties resulting from inaccuracy or errors of or concerning such information.

Looking for pricing, stock, or lifecycle information?

Click below to explore more details on WIN SOURCE:

-  [View BR25L640F-WE2 on WIN SOURCE](#)
-  [Rohm Semiconductor](#) Information

Optimize Your Supply Chain with WIN SOURCE Solutions

-  Global Sourcing Solution
-  Obsolete Management
-  Cost Control Management
-  Shortage Management
-  Alternative Solution
-  Excess Inventory Management