



**THE DATASHEET OF  
MSA-0286-TR1G**



# MSA-0286

## Cascadable Silicon Bipolar MMIC Amplifier



### Data Sheet

#### Description

The MSA-0286 is a high performance silicon bipolar Monolithic Microwave Integrated Circuit (MMIC) housed in a low cost, surface mount plastic package. This MMIC is designed for use as a general purpose 50Ω gain block. Typical applications include narrow and broad band IF and RF amplifiers in commercial and industrial applications.

The MSA-series is fabricated using Avago's 10 GHz  $f_T$ , 25 GHz  $f_{MAX}$ , silicon bipolar MMIC process which uses nitride self-alignment, ion implantation, and gold metallization to achieve excellent performance, uniformity and reliability. The use of an external bias resistor for temperature and current stability also allows bias flexibility.

#### Features

- Cascadable 50 Ω Gain Block
- 3 dB Bandwidth: DC to 2.5 GHz
- 12.0 dB Typical Gain at 1.0 GHz
- Unconditionally Stable ( $k > 1$ )
- Surface Mount Plastic Package
- Tape-and-Reel Packaging Option Available
- Lead-free Option Available

#### 86 Plastic Package

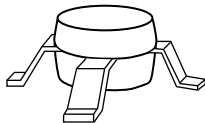

#### Typical Biasing Configuration

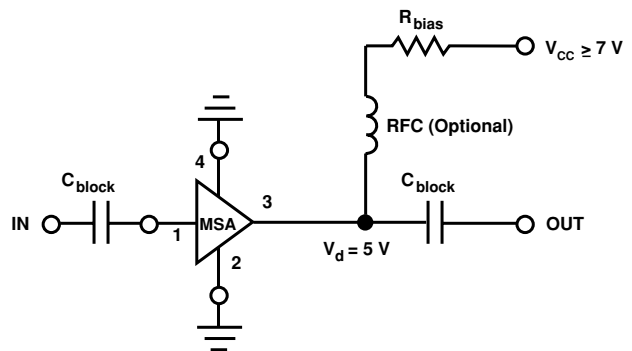

### MSA-0286 Absolute Maximum Ratings

Parameter	Absolute Maximum <sup>[1]</sup>
Device Current	60 mA
Power Dissipation <sup>[2,3]</sup>	325 mW
RF Input Power	+13 dBm
Junction Temperature	150°C
Storage Temperature	-65 to 150°C

#### Thermal Resistance<sup>[2]:</sup>

$$\theta_{jc} = 105^{\circ}\text{C}/\text{W}$$

#### Notes:

1. Permanent damage may occur if any of these limits are exceeded.
2.  $T_{\text{CASE}} = 25^{\circ}\text{C}$ .
3. Derate at 9.5 mW/°C for  $T_{\text{C}} > 116^{\circ}\text{C}$ .

### Electrical Specifications<sup>[1]</sup>, $T_{\text{A}} = 25^{\circ}\text{C}$

Symbol	Parameters and Test Conditions: $I_{\text{d}} = 25 \text{ mA}$ , $Z_{\text{o}} = 50 \Omega$	Units	Min.	Typ.	Max.
$G_{\text{P}}$	Power Gain ( $ S_{21} ^2$ ) f = 0.1 GHz f = 1.0 GHz	dB	10.0	12.5 12.0	
$\Delta G_{\text{P}}$	Gain Flatness f = 0.1 to 1.6 GHz	dB		$\pm 0.6$	
$f_{3 \text{ dB}}$	3 dB Bandwidth	GHz		2.5	
VSWR	Input VSWR f = 0.1 to 3.0 GHz			1.5:1	
	Output VSWR f = 0.1 to 3.0 GHz			1.4:1	
NF	50 $\Omega$ Noise Figure f = 1.0 GHz	dB		6.5	
$P_{1 \text{ dB}}$	Output Power at 1 dB Gain Compression f = 1.0 GHz	dBm		4.5	
$\text{IP}_3$	Third Order Intercept Point f = 1.0 GHz	dBm		17.0	
tD	Group Delay f = 1.0 GHz	psec		140	
$V_{\text{d}}$	Device Voltage	V	4.0	5.0	6.0
dV/dT	Device Voltage Temperature Coefficient	mV/°C		-8.0	

#### Note:

1. The recommended operating current range for this device is 18 to 40 mA. Typical performance as a function of current is on the following page.

### Ordering Information

Part Numbers	No. of Devices	Comments
MSA-0286-BLK	100	Bulk
MSA-0286-BLKG	100	Bulk
MSA-0286-TR1	1000	7" Reel
MSA-0286-TR1G	1000	7" Reel
MSA-0286-TR2	4000	13" Reel
MSA-0286-TR2G	4000	13" Reel

**Note:** Order part number with a "G" suffix if lead-free option is desired.

**MSA-0286 Typical Scattering Parameters ( $Z_0 = 50 \Omega$ ,  $T_A = 25^\circ\text{C}$ ,  $I_d = 25 \text{ mA}$ )**

Freq. GHz	$S_{11}$		$S_{21}$			$S_{12}$			$S_{22}$	
	Mag	Ang	dB	Mag	Ang	dB	Mag	Ang	Mag	Ang
0.1	.10	171	12.5	4.22	175	-18.5	.119	1	.16	-5
0.2	.10	161	12.5	4.20	170	-18.3	.121	3	.16	-11
0.4	.10	144	12.4	4.16	159	-18.2	.122	6	.15	-24
0.6	.09	129	12.2	4.09	149	-18.0	.126	6	.15	-36
0.8	.08	119	12.1	4.01	139	-18.0	.127	9	.14	-48
1.0	.08	108	11.9	3.91	129	-17.4	.135	8	.14	-62
1.5	.06	111	11.3	3.67	106	-16.5	.149	12	.11	-99
2.0	.08	141	10.5	3.35	84	-15.7	.164	11	.11	-141
2.5	.14	150	9.6	3.01	67	-14.8	.182	9	.12	-176
3.0	.21	142	8.6	2.68	48	-14.3	.194	5	.13	155
3.5	.29	132	7.5	2.37	30	-14.0	.200	1	.14	140
4.0	.36	121	6.4	2.09	15	-13.5	.211	-3	.16	134
5.0	.50	101	4.1	1.61	-12	-13.3	.216	-12	.20	132

**Typical Performance,  $T_A = 25^\circ\text{C}$** 

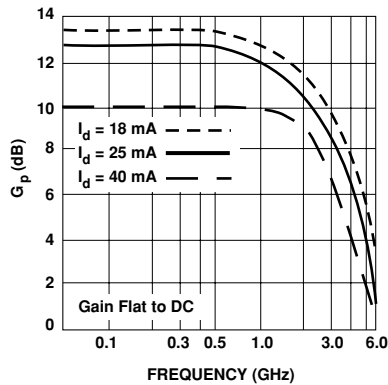
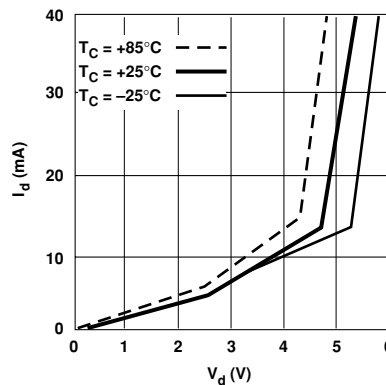
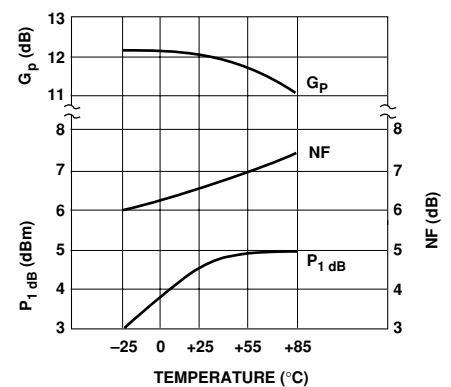
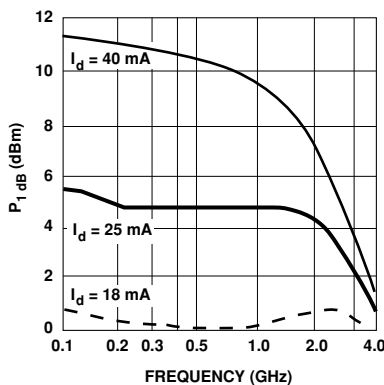
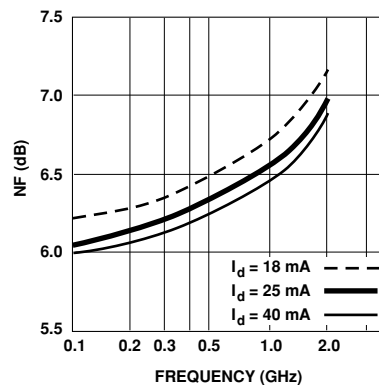

(unless otherwise noted)

**Figure 1. Typical Power Gain vs. Frequency.**

**Figure 2. Device Current vs. Voltage.**

**Figure 3. Output Power at 1 dB Gain Compression, NF and Power Gain vs. Case Temperature,  $f = 1.0 \text{ GHz}$ ,  $I_d = 25 \text{ mA}$ .**

**Figure 4. Output Power at 1 dB Gain Compression vs. Frequency.**

**Figure 5. Noise Figure vs. Frequency.**



## Looking for pricing, stock, or lifecycle information?

Click below to explore more details on WIN SOURCE:

-  [View MSA-0286-TR1G on WIN SOURCE](#)
-  [Broadcom Limited Information](#)

## Optimize Your Supply Chain with WIN SOURCE Solutions

-  Global Sourcing Solution
-  Obsolete Management
-  Cost Control Management
-  Shortage Management
-  Alternative Solution
-  Excess Inventory Management