



**THE DATASHEET OF
S2S4B00F**



S2S4 Series

*Non-zero cross type is also available. (**S2S3 Series**)

V_{DRM} : 600V, Zero cross type Mini-Flat Package Phototriac Coupler for triggering



■ Description

S2S4 Series Phototriac Coupler include an infrared emitting diode (IRED) optically coupled to an output Phototriac.

These devices feature full wave control and are ideal isolated drivers for medium to high current Triacs.

SOP package provides 3.75kV isolation from input to output with superior commutative noise immunity.

■ Features

1. High repetitive peak off-state voltage (V_{DRM} : 600V)
2. Zero crossing functionality (V_{OX} : MAX. 35V)
3. I_{FT} ranks available (see Model Line-up section in this datasheet)
4. 4 pin Mini-flat package
5. Superior noise immunity (dV/dt : MIN. 100V/μs)
6. Double transfer mold construction (Ideal for Flow Soldering)
7. High isolation voltage between input and output (V_{iso(rms)} : 3.75kV)

■ Agency approvals/Compliance

1. Recognized by UL1577 (Double protection isolation), file No. E64380 (as model No. **S2S4**)
2. Approved by CSA, file No. CA95323 (as model No. **S2S4**)
3. Optionary available VDE Approved ^(*)(DIN EN 60747-5-2), file No. 40009162 (as model No. **S2S4**)
4. Package resin : UL flammability grade (94V-0)

^(*) DIN EN60747-5-2 : successor standard of DIN VDE0884.
Up to Date code "RD" (December 2003), approval of DIN VDE0884.

From Date code "S1" (January 2004), approval of DIN EN60747-5-2.

^(**) Reinforced insulation type is also available.
(**PC3SG21YIZ Series**)

■ Applications

1. Triggering for Triacs used to switch on and off devices which require AC Loads.
For example heaters, fans, motors, solenoids, and valves.
2. AC line control in power supply applications.

Notice The content of data sheet is subject to change without prior notice.

In the absence of confirmation by device specification sheets, SHARP takes no responsibility for any defects that may occur in equipment using any SHARP devices shown in catalogs, data books, etc. Contact SHARP in order to obtain the latest device specification sheets before using any SHARP device.

Internal Connection Diagram

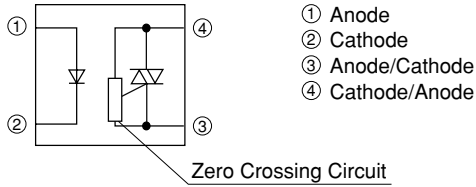

Outline Dimensions

(Unit : mm)

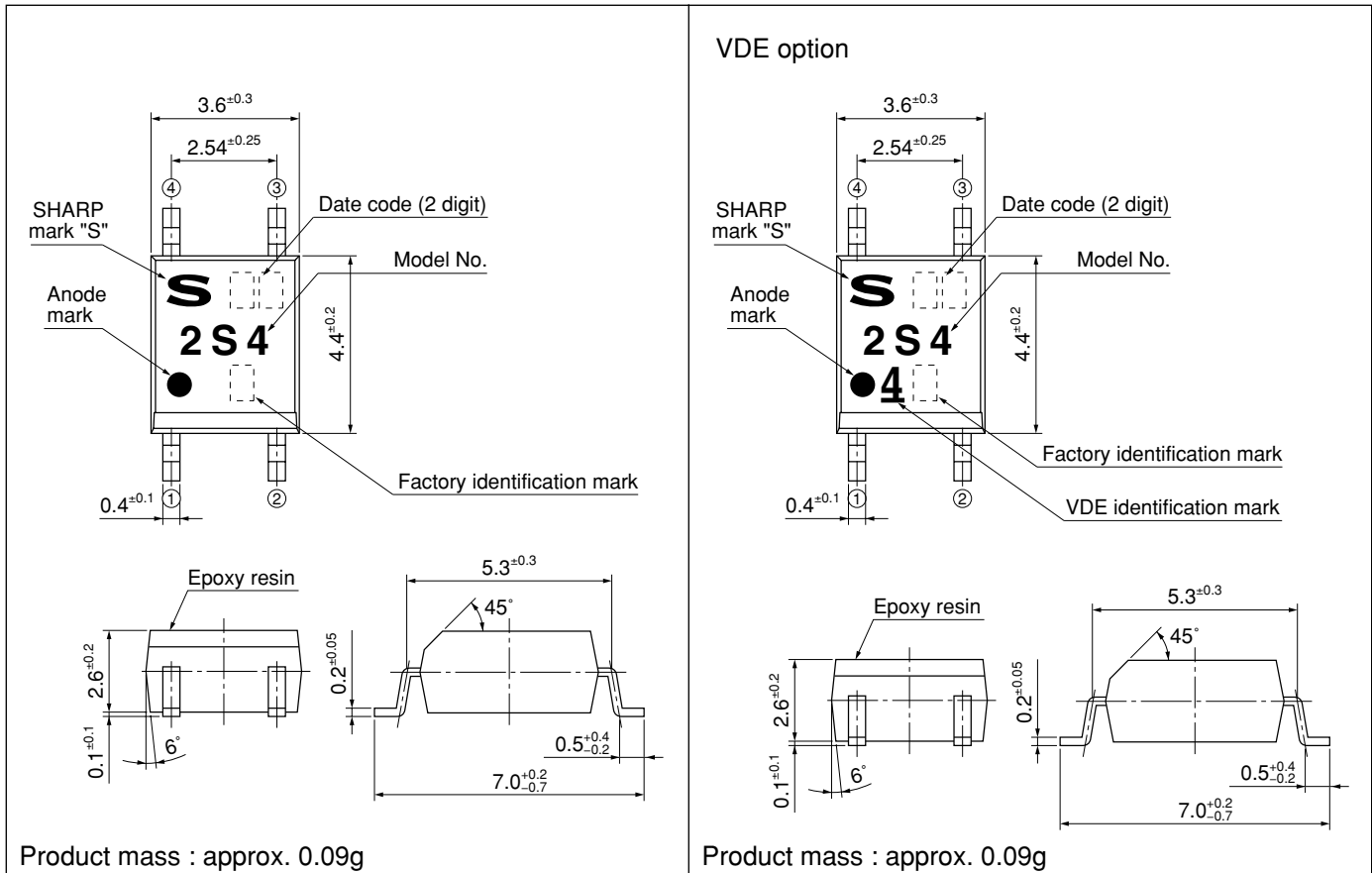





Date code (2 digit)

1st digit				2nd digit	
Year of production				Month of production	
A.D.	Mark	A.D.	Mark	Month	Mark
1990	A	2002	P	January	1
1991	B	2003	R	February	2
1992	C	2004	S	March	3
1993	D	2005	T	April	4
1994	E	2006	U	May	5
1995	F	2007	V	June	6
1996	H	2008	W	July	7
1997	J	2009	X	August	8
1998	K	2010	A	September	9
1999	L	2011	B	October	O
2000	M	2012	C	November	N
2001	N	∴	∴	December	D

repeats in a 20 year cycle

Factory identification mark

Factory identification Mark	Country of origin
no mark	Japan
	
	Indonesia
	Philippines
	China

* This factory marking is for identification purpose only.
Please contact the local SHARP sales representative to see the actual status of the production.

Rank mark

There is no rank mark indicator.

■ Absolute Maximum Ratings (T_a=25°C)

Parameter	Symbol	Rating	Unit	
Input	Forward current	I _F	50	mA
	Reverse voltage	V _R	6	V
Output	RMS ON-state current	I _{T(rms)}	0.05	A
	Peak one cycle surge current	I _{surge}	0.6 ^{*3}	A
	Repetitive peak OFF-state voltage	V _{DRM}	600	V
*1 Isolation voltage	V _{iso(rms)}	3.75	kV	
Operating temperature	T _{opr}	-30 to +100	°C	
Storage temperature	T _{stg}	-40 to +125	°C	
*2 Soldering temperature	T _{sol}	260	°C	

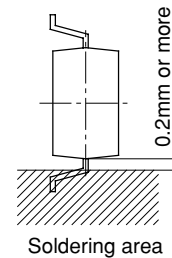

*1 40 to 60%RH, AC for 1minute, f=60Hz

*2 For 10s

*3 f=50Hz sine wave

■ Electro-optical Characteristics (T_a=25°C)

Parameter		Symbol	Conditions	MIN.	TYP.	MAX.	Unit
Input	Forward voltage	V _F	I _F =20mA	-	1.2	1.4	V
	Reverse current	I _R	V _R =3V	-	-	10	μA
Output	Repetitive peak OFF-state current	I _{DRM}	V _D =V _{DRM}	-	-	1	μA
	ON-state voltage	V _T	I _T =0.05A	-	-	2.5	V
	Holding current	I _H	V _D =6V	0.1	-	3.5	mA
	Critical rate of rise of OFF-state voltage	dV/dt	V _D =1/√2 · V _{DRM}	100	1 000	-	V/μs
	Zero-cross voltage	V _{OX}	I _F =15mA, Resistance load	-	-	35	V
Transfer characteristics	Minimum trigger current	No rank	V _D =6V, R _L =100Ω	-	-	10	mA
		Rank R		-	-	7	
		Rank L		-	-	5	
	Isolation resistance	R _{ISO}	DC500V, 40 to 60%RH	5×10 ¹⁰	10 ¹¹	-	Ω
Turn-on time	t _{on}	V _D =6V, R _L =100Ω, I _F =20mA	-	-	50	μs	

■ Model Line-up

Shipping Package	Sleeve		Taping				I _{FT} rank	I _{FT} [mA] (V _D =6V, R _L =100Ω)
	100pcs/sleeve		3 000pcs/reel		750pcs/reel			
DIN EN60747-5-2	—	Approved	—	Approved	—	Approved		
Model No.	S2S4000F	S2S4Y00F	S2S4A00F	S2S4AY0F	S2S4B00F	S2S4BY0F	No rank	MAX. 10
	S2S4R00F	S2S4RY0F	S2S4RA0F	S2S4RAYF	S2S4RBOF	S2S4RBYF	Rank R	MAX. 7
	S2S4L00F	S2S4LY0F	S2S4LA0F	—	S2S4LBOF	—	Rank L	MAX. 5

Please contact a local SHARP sales representative to inquire about production status.

Fig.1 Forward Current vs. Ambient Temperature

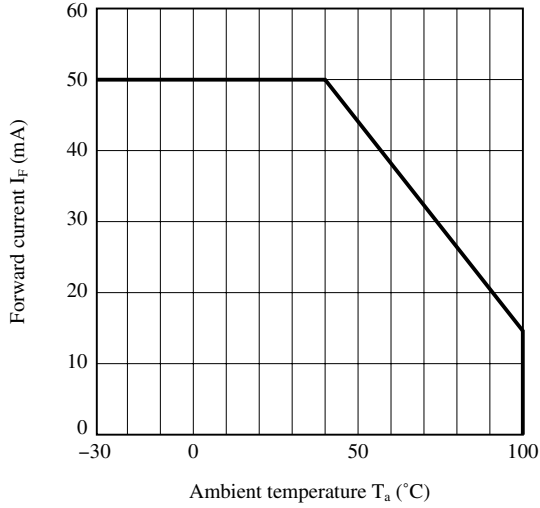

Fig.2 RMS ON-state Current vs. Ambient Temperature

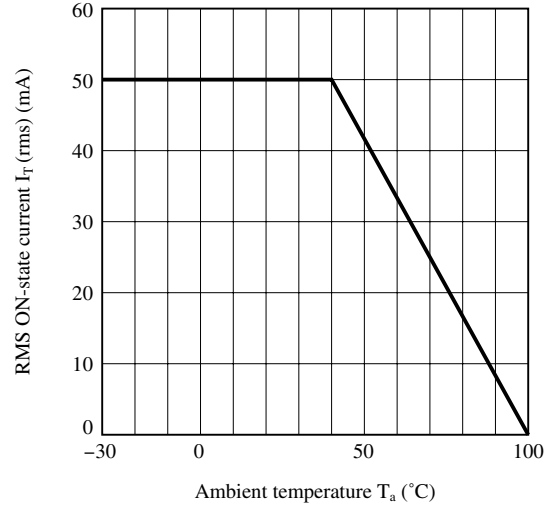

Fig.3 Forward Current vs. Forward Voltage

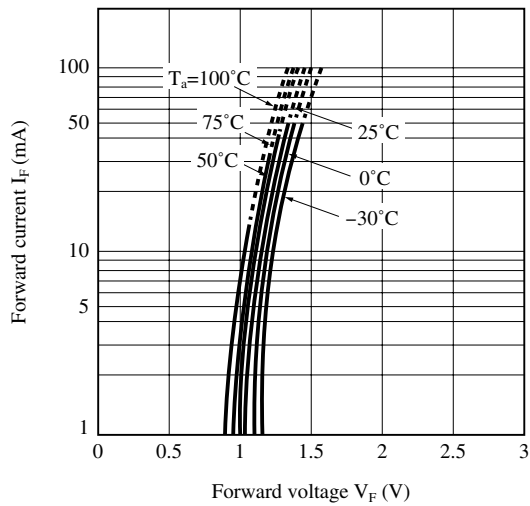

Fig.4 Minimum Trigger Current vs. Ambient Temperature

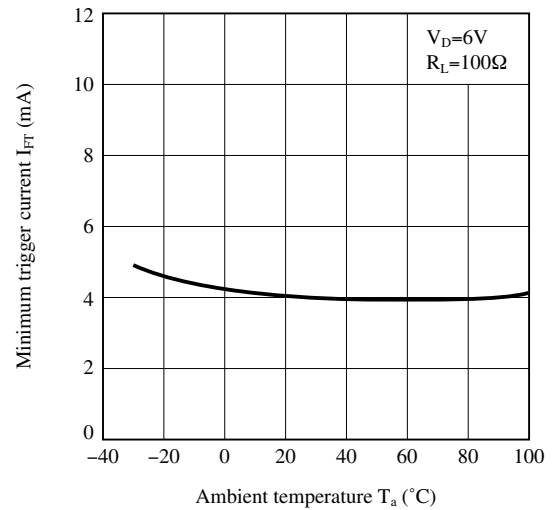

Fig.5 Relative Repetitive Peak OFF-state Voltage vs. Ambient Temperature

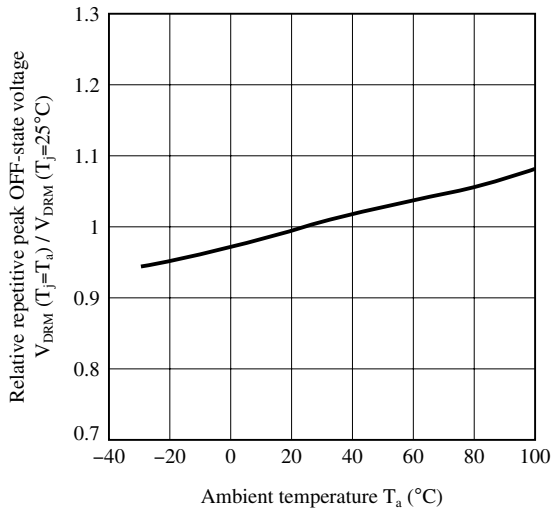

Fig.6 ON-state Voltage vs. Ambient Temperature

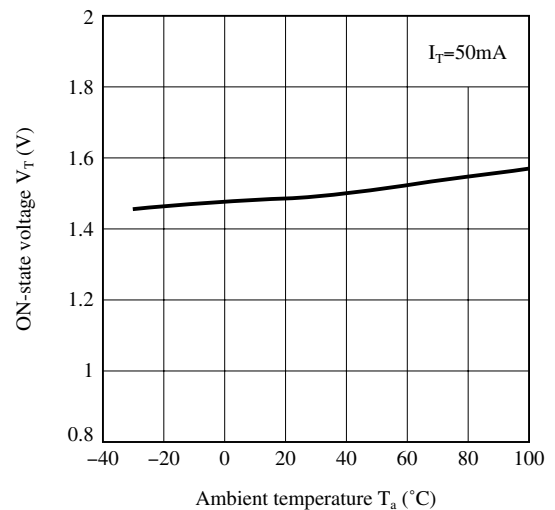

Fig.7 Holding Current vs. Ambient Temperature

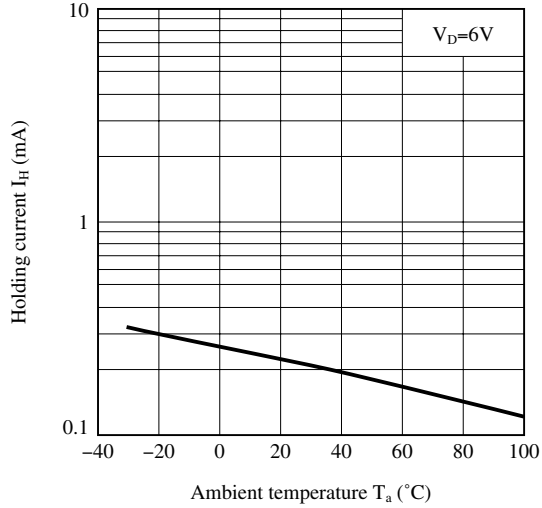

Fig.8 Repetitive Peak OFF-state Current vs. OFF-state Voltage

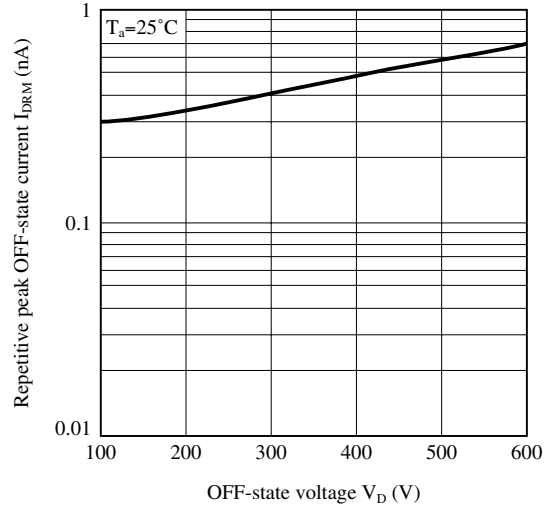

Fig.9 Relative Repetitive Peak OFF-state Current vs. Ambient Temperature

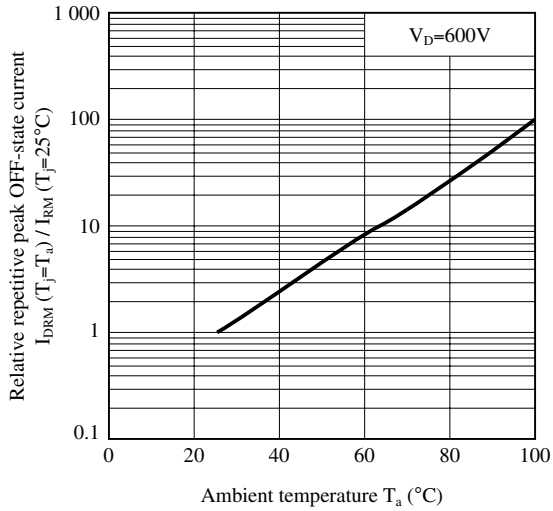

Fig.10 Turn-on Time vs. Forward Current

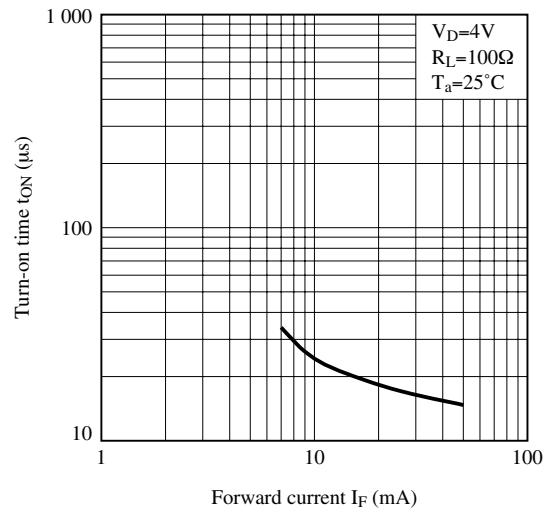

Fig.11 Zero-cross Voltage vs. Ambient Temperature

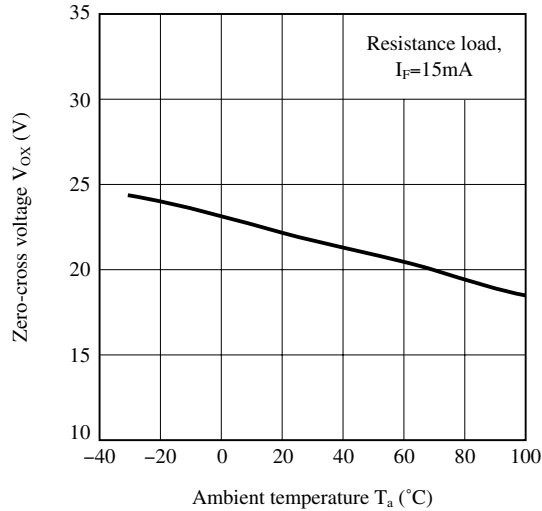
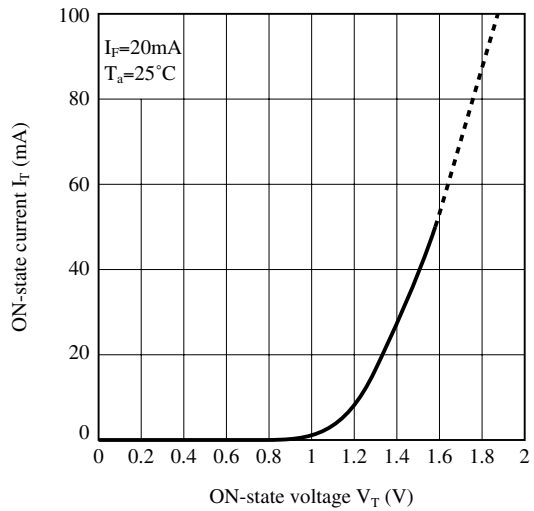

Fig.12 ON-state Current vs. ON-state Voltage



Remarks : Please be aware that all data in the graph are just for reference.

■ **Design Considerations**

● **Design guide**

In order for the Phototriac to turn off, the triggering current (I_F) must be 0.1mA or less.

Please refrain from using these devices in a direct drive configuration. These Phototriac Coupler are intended to be used as triggering device for main Triacs. Please ensure that the output rating of these devices will be sufficient for triggering the main output Triac of your choice. Failure to do may result in malfunctions.

For applications with inductive loads such as motors, please use caution in utilizing a zero crossing type Phototriac Coupler as this may cause undesired operations due to the phase difference between voltage and current of load.

For designs that will experience excessive noise or sudden changes in load voltage, please include an appropriate snubber circuit as shown in the below circuit. Please keep in mind the Sharp Phototriac Coupler incorporate superior dV/dt ratings which can eliminate the need for a snubber circuit.

For over voltage protection, a Varistor may be used.

● **Degradation**

In general, the emission of the IRED used in Phototriac Couplers will degrade over time.

In the case where long term operation and / or constant extreme temperature fluctuations will be applied to the devices, please allow for a worst case scenario of 50% degradation over 5years.

Therefore in order to maintain proper operation, a design implementing these Phototriac Couplers should provide at least twice the minimum required triggering current from initial operation.

● **Recommended Foot Print (reference)**

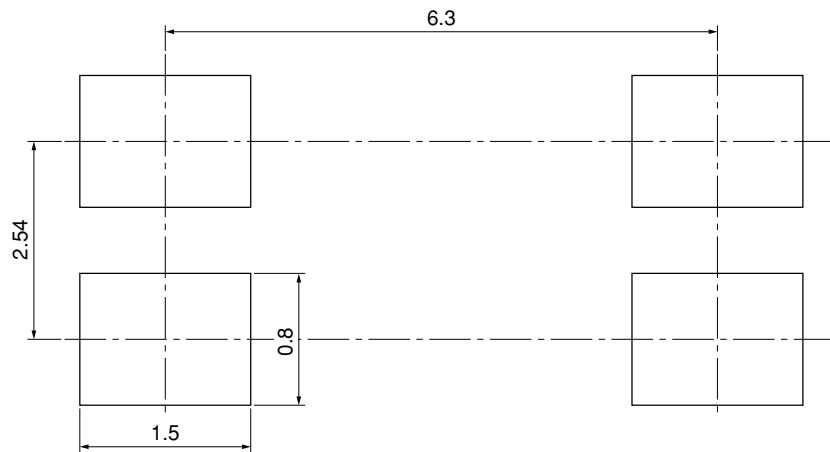

(Unit : mm)

● **Standard Circuit (Medium/High Power Triac Drive Circuit)**

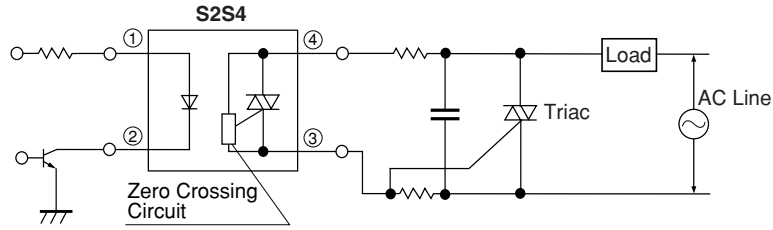

Note) Please add the snubber circuit according to a condition.
 Any snubber or varistor used for the above mentioned scenarios should be located as close to the main output triac as possible.

■ Manufacturing Guidelines

● Soldering Method

Reflow Soldering:

Reflow soldering should follow the temperature profile shown below.

Soldering should not exceed the curve of temperature profile and time.

Please don't solder more than twice.



Flow Soldering :

Due to SHARP's double transfer mold construction submersion in flow solder bath is allowed under the below listed guidelines.

Flow soldering should be completed below 260°C and within 10s.

Preheating is within the bounds of 100 to 150°C and 30 to 80s.

Please don't solder more than twice.

Hand soldering

Hand soldering should be completed within 3s when the point of solder iron is below 400°C.

Please don't solder more than twice.

Other notices

Please test the soldering method in actual condition and make sure the soldering works fine, since the impact on the junction between the device and PCB varies depending on the tooling and soldering conditions.

● Cleaning instructions**Solvent cleaning :**

Solvent temperature should be 45°C or below. Immersion time should be 3minutes or less.

Ultrasonic cleaning :

The impact on the device varies depending on the size of the cleaning bath, ultrasonic output, cleaning time, size of PCB and mounting method of the device.

Therefore, please make sure the device withstands the ultrasonic cleaning in actual conditions in advance of mass production.

Recommended solvent materials :

Ethyl alcohol, Methyl alcohol and Isopropyl alcohol.

In case the other type of solvent materials are intended to be used, please make sure they work fine in actual using conditions since some materials may erode the packaging resin.

● Presence of ODC

This product shall not contain the following materials.

And they are not used in the production process for this device.

Regulation substances : CFCs, Halon, Carbon tetrachloride, 1.1.1-Trichloroethane (Methylchloroform)

Specific brominated flame retardants such as the PBBOs and PBBs are not used in this product at all.

■ **Package specification**

● **Sleeve package**

Package materials

Sleeve : HIPS (with anti-static material)

Stopper : Styrene-Elastomer

Package method

MAX. 100pcs of products shall be packaged in a sleeve.

Both ends shall be closed by tabbed and tabless stoppers.

The product shall be arranged in the sleeve with its anode mark on the tabless stopper side.

MAX. 50 sleeves in one case.

Sleeve outline dimensions

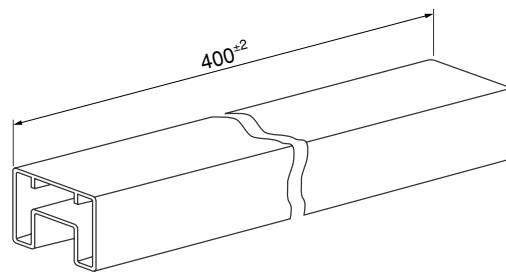
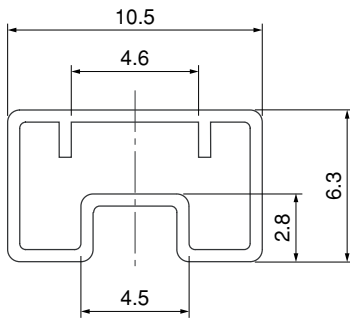

(Unit : mm)

● **Tape and Reel package**

1. 3 000pcs/reel

Package materials

Carrier tape : A-PET (with anti-static material)

Cover tape : PET (three layer system)

Reel : PS

Carrier tape structure and Dimensions

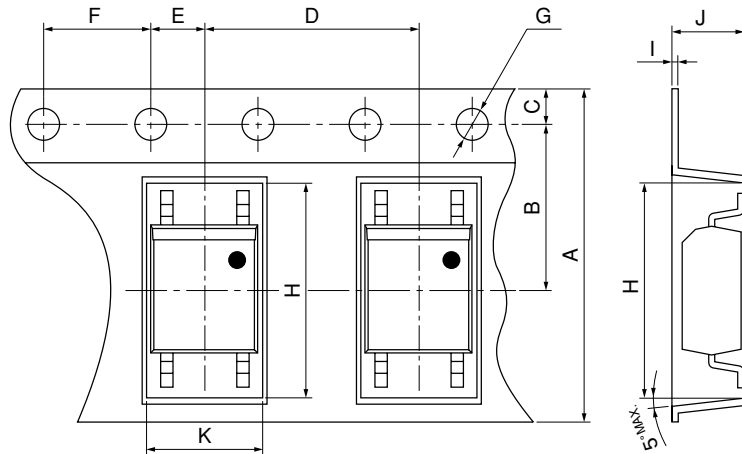

Dimensions List (Unit : mm)

A	B	C	D	E	F	G
12.0±0.3	5.5±0.1	1.75±0.1	8.0±0.1	2.0±0.1	4.0±0.1	φ1.5±0.1
H	I	J	K			
7.4±0.1	0.3±0.05	3.1±0.1	4.0±0.1			

Reel structure and Dimensions

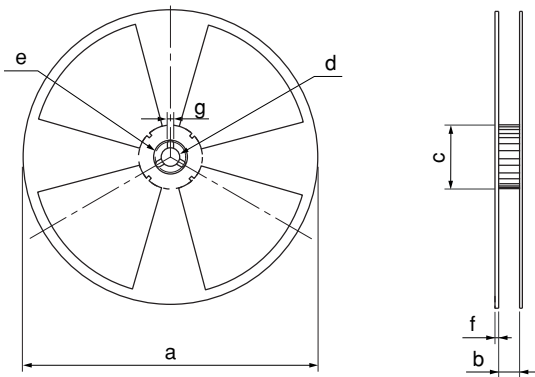

Dimensions List (Unit : mm)

a	b	c	d
370	13.5±1.5	80±1.0	13±0.5
e	f	g	
21±1.0	2.0±0.5	2.0±0.5	

Direction of product insertion

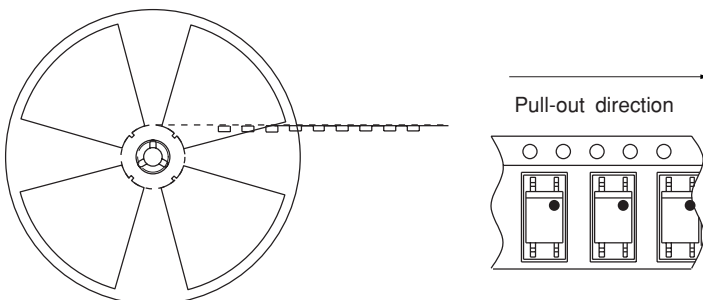

[Packing : 3 000pcs/reel]

2. 750pcs/reel

Package materials

Carrier tape : A-PET (with anti-static material)

Cover tape : PET (three layer system)

Reel : PS

Carrier tape structure and Dimensions

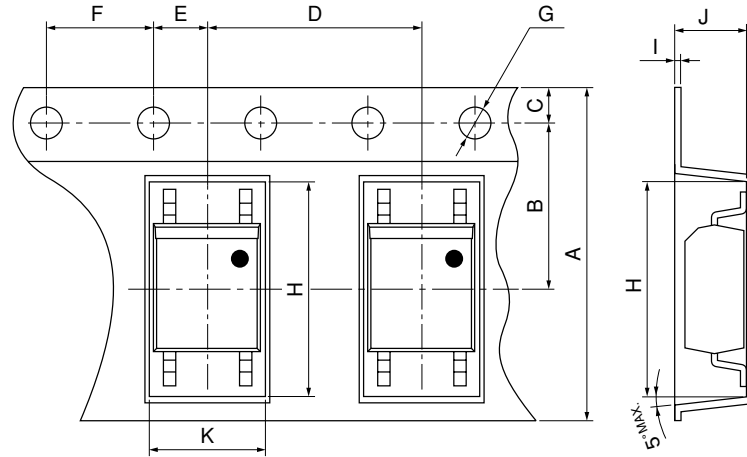

Dimensions List							(Unit : mm)
A	B	C	D	E	F	G	
12.0±0.3	5.5±0.1	1.75±0.1	8.0±0.1	2.0±0.1	4.0±0.1	φ1.5±0.1	
H	I	J	K				
7.4±0.1	0.3±0.05	3.1±0.1	4.0±0.1				

Reel structure and Dimensions

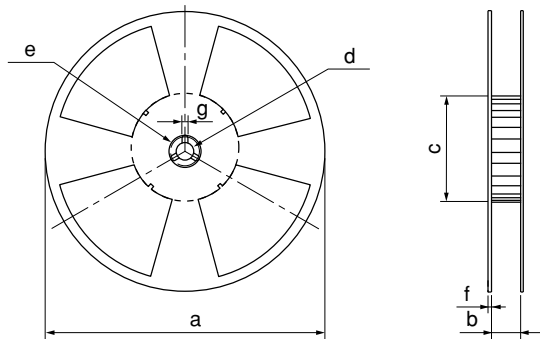

Dimensions List				(Unit : mm)
a	b	c	d	
180	13.5±1.5	80±1.0	13±0.5	
e	f	g		
21±1.0	2.0±0.5	2.0±0.5		

Direction of product insertion

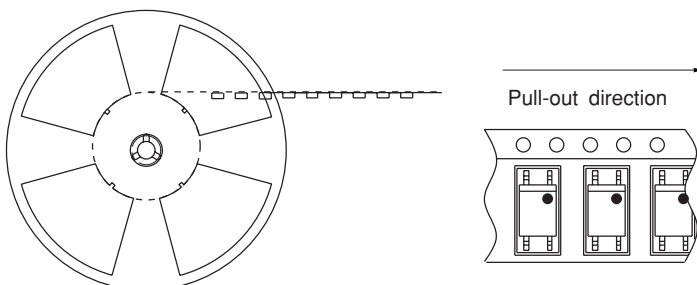

[Packing : 750pcs/reel]

■ Important Notices

· The circuit application examples in this publication are provided to explain representative applications of SHARP devices and are not intended to guarantee any circuit design or license any intellectual property rights. SHARP takes no responsibility for any problems related to any intellectual property right of a third party resulting from the use of SHARP's devices.

· Contact SHARP in order to obtain the latest device specification sheets before using any SHARP device. SHARP reserves the right to make changes in the specifications, characteristics, data, materials, structure, and other contents described herein at any time without notice in order to improve design or reliability. Manufacturing locations are also subject to change without notice.

· Observe the following points when using any devices in this publication. SHARP takes no responsibility for damage caused by improper use of the devices which does not meet the conditions and absolute maximum ratings to be used specified in the relevant specification sheet nor meet the following conditions:

(i) The devices in this publication are designed for use in general electronic equipment designs such as:

- Personal computers
- Office automation equipment
- Telecommunication equipment [terminal]
- Test and measurement equipment
- Industrial control
- Audio visual equipment
- Consumer electronics

(ii) Measures such as fail-safe function and redundant design should be taken to ensure reliability and safety when SHARP devices are used for or in connection

with equipment that requires higher reliability such as:

- Transportation control and safety equipment (i.e., aircraft, trains, automobiles, etc.)
- Traffic signals
- Gas leakage sensor breakers
- Alarm equipment
- Various safety devices, etc.

(iii) SHARP devices shall not be used for or in connection with equipment that requires an extremely high level of reliability and safety such as:

- Space applications
- Telecommunication equipment [trunk lines]
- Nuclear power control equipment
- Medical and other life support equipment (e.g., scuba).

· If the SHARP devices listed in this publication fall within the scope of strategic products described in the Foreign Exchange and Foreign Trade Law of Japan, it is necessary to obtain approval to export such SHARP devices.

· This publication is the proprietary product of SHARP and is copyrighted, with all rights reserved. Under the copyright laws, no part of this publication may be reproduced or transmitted in any form or by any means, electronic or mechanical, for any purpose, in whole or in part, without the express written permission of SHARP. Express written permission is also required before any use of this publication may be made by a third party.

· Contact and consult with a SHARP representative if there are any questions about the contents of this publication.

Looking for pricing, stock, or lifecycle information?

Click below to explore more details on WIN SOURCE:

- ⊖ [View S2S4B00F on WIN SOURCE](#)
- ⊖ [Sharp Microelectronics Information](#)

Optimize Your Supply Chain with WIN SOURCE Solutions

- ✓ Global Sourcing Solution
- ✓ Obsolete Management
- ✓ Cost Control Management
- ✓ Shortage Management
- ✓ Alternative Solution
- ✓ Excess Inventory Management