



**THE DATASHEET OF
AD9895KBCZRL**



AD9891/AD9895

FEATURES

AD9891: 10-Bit 20 MHz Version
AD9895: 12-Bit 30 MHz Version
Correlated Double Sampler (CDS)
4 ±6 dB Pixel Gain Amplifier (PxGA)[®]
2 dB to 36 dB 10-Bit Variable Gain Amplifier (VGA)
10-Bit 20 MHz A/D Converter (AD9891)
12-Bit 30 MHz A/D Converter (AD9895)
Black Level Clamp with Variable Level Control
Complete On-Chip Timing Generator
***Precision Timing* Core with 1 ns Resolution**
On-Chip 5 V Horizontal and RG Drivers
2-Phase and 4-Phase H-Clock Modes
4-Phase Vertical Transfer Clocks
Electronic and Mechanical Shutter Modes
On-Chip Driver for External Crystal
On-Chip Sync Generator with External Sync Option
64-Lead CSPBGA Package

APPLICATIONS

Digital Still Cameras
Digital Video Camcorders
Industrial Imaging

PRODUCT DESCRIPTION

The AD9891 and AD9895 are highly integrated CCD signal processors for digital still camera applications. Both include a complete analog front end with A/D conversion combined with a full-function programmable timing generator. A *Precision Timing* core allows adjustment of high speed clocks with 1 ns resolution at 20 MHz operation and 700 ps resolution at 30 MHz operation.

The AD9891 is specified at pixel rates of up to 20 MHz, and the AD9895 is specified at 30 MHz. The analog front end includes black level clamping, CDS, PxGA, VGA, and a 10-Bit or 12-Bit A/D converter. The timing generator provides all the necessary CCD clocks: RG, H-clocks, V-clocks, sensor gate pulses, substrate clock, and substrate bias control. Operation is programmed using a 3-wire serial interface.

Packaged in a space-saving 64-lead CSPBGA, the AD9891 and AD9895 are specified over an operating temperature range of -20°C to +85°C.

FUNCTIONAL BLOCK DIAGRAM

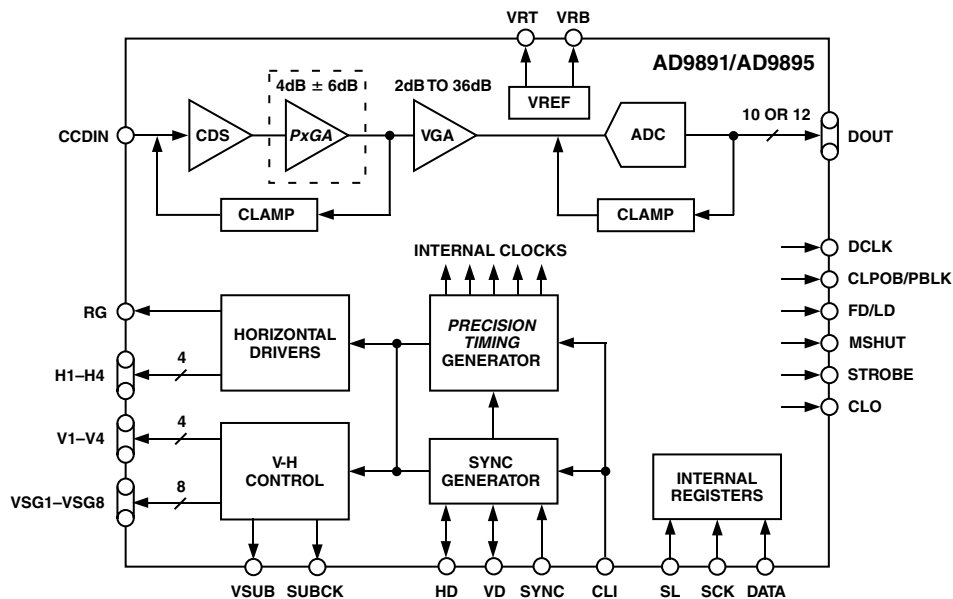

PxGA is a registered trademark and Precision Timing is a trademark of Analog Devices, Inc.

REV. A

Information furnished by Analog Devices is believed to be accurate and reliable. However, no responsibility is assumed by Analog Devices for its use, nor for any infringements of patents or other rights of third parties that may result from its use. No license is granted by implication or otherwise under any patent or patent rights of Analog Devices.

AD9891/AD9895

TABLE OF CONTENTS

SPECIFICATIONS	3	Frame Transfer CCD Mode	24
DIGITAL SPECIFICATIONS	3	Vertical Sensor Gate (Shift Gate) Timing	25
AD9891 ANALOG SPECIFICATIONS	4	SHUTTER TIMING CONTROL	26
AD9895 ANALOG SPECIFICATIONS	5	Normal Shutter Mode	26
TIMING SPECIFICATIONS	6	High Precision Shutter Mode	26
PACKAGE THERMAL CHARACTERISTICS	6	Low Speed Shutter Mode	26
ABSOLUTE MAXIMUM RATINGS	6	SUBCK Suppression	26
ORDERING GUIDE	6	Readout After Exposure	27
PIN CONFIGURATION-AD9891	7	VSub Control	27
PIN FUNCTION DESCRIPTIONS-AD9891	7	MSHUT and STROBE Control	27
PIN CONFIGURATION-AD9895	8	Example of Exposure and Readout of Interlaced Frame	29
PIN FUNCTION DESCRIPTIONS-AD9895	8	ANALOG FRONT END DESCRIPTION AND	
SPECIFICATION DEFINITIONS	9	OPERATION	30
EQUIVALENT CIRCUITS	9	DC Restore	30
TYPICAL PERFORMANCE CHARACTERISTICS	10	Correlated Double Sampler	30
SYSTEM OVERVIEW	11	Input Clamp	30
Typical System Block Diagram	11	PxGA	30
PRECISION TIMING HIGH SPEED TIMING		PxGA Color Steering Mode Timing	31
GENERATION	12	Variable Gain Amplifier	33
Timing Resolution	12	PxGA and VGA Gain Curves	33
High Speed Clock Programmability	12	Optical Black Clamp	33
H-Driver and RG Outputs	13	A/D Converter	33
Digital Data Outputs	13	POWER-UP AND SYNCHRONIZATION	34
HORIZONTAL CLAMPING AND BLANKING	15	Recommended Power-Up Sequence for Master Mode	34
Individual CLPOB, CLPDM, and PBLK Sequences	15	SYNC During Master Mode Operation	35
Individual HBLK Sequences	15	Synchronization in Slave Mode	35
Horizontal Sequence Control	15	POWER-DOWN MODE OPERATION	35
VERTICAL TIMING GENERATION	17	HORIZONTAL TIMING SEQUENCE EXAMPLE	37
Individual Vertical Sequences	18	VERTICAL TIMING EXAMPLE	39
Individual Vertical Regions	19	CIRCUIT LAYOUT INFORMATION	40
Complete Field: Combining the Regions	20	SERIAL INTERFACE TIMING	41
Vertical Sequence Alteration	21	Notes About Accessing a Double-Wide Register	41
Second Vertical Sequence During VSG Lines	22	NOTES ON REGISTER LISTING	42
Vertical Sweep Mode Operation	22	COMPLETE REGISTER LISTING	43
Vertical Multiplier Mode	24	OUTLINE DIMENSIONS	57
		REVISION HISTORY	57

AD9891/AD9895—SPECIFICATIONS

Parameter	Min	Typ	Max	Unit
TEMPERATURE RANGE				
Operating	-20		+85	°C
Storage	-65		+150	°C
POWER SUPPLY VOLTAGE				
AVDD1, AVDD2 (AFE Analog Supply)	2.7	3.0	3.6	V
TCVDD (Timing Core Analog Supply)	2.7	3.0	3.6	V
RGVDD (RG Driver)	3.0	5.0	5.25	V
HVDD (H1–H4 Drivers)	3.0	5.0	5.25	V
DRVDD (Data Output Drivers)	2.7	3.0	3.6	V
DVDD (Digital)	2.7	3.0	3.6	V
POWER DISSIPATION—AD9891 (See TPC 1 for Power Curves)				
20 MHz, Typ Supply Levels, 100 pF H1–H4 Loading		380		mW
Power from HVDD Only*		220		mW
Power-Down 1 Mode		42		mW
Power-Down 2 Mode		8		mW
Power-Down 3 Mode		2.5		mW
POWER DISSIPATION—AD9895 (See TPC 4 for Power Curves)				
30 MHz, Typ Supply Levels, 100 pF H1–H4 Loading		600		mW
Power from HVDD Only*		320		mW
Power-Down 1 Mode		138		mW
Power-Down 2 Mode		22		mW
Power-Down 3 Mode		2.5		mW
MAXIMUM CLOCK RATE (CLI)				
AD9891	20			MHz
AD9895	30			MHz

*The total power dissipated by the HVDD supply may be approximated using the equation:

$$\text{Total HVDD Power} = [C_{\text{LOAD}} \times \text{HVDD} \times \text{Pixel Frequency}] \times \text{HVDD} \times \text{Number of H-Outputs Used}$$

Reducing the H-loading, using only two of the outputs, and/or using a lower HVDD supply will reduce the power dissipation. Actual HVDD power may be slightly higher than the calculated value because of stray capacitance inherent in the PCB layout/routing. Specifications subject to change without notice.

DIGITAL SPECIFICATIONS (RGVDD = HVDD = 4.75 V to 5.25 V, DVDD = DRVDD = 2.7 V to 3.5 V, C_L = 20 pF, T_{MIN} to T_{MAX}, unless otherwise noted.)

Parameter	Symbol	Min	Typ	Max	Unit
LOGIC INPUTS					
High Level Input Voltage	V _{IH}	2.1			V
Low Level Input Voltage	V _{IL}			0.6	V
High Level Input Current	I _{IH}		10		μA
Low Level Input Current	I _{IL}		10		μA
Input Capacitance	C _{IN}		10		pF
LOGIC OUTPUTS (Except H and RG)					
High Level Output Voltage @ I _{OH} = 2 mA	V _{OH}	2.2			V
Low Level Output Voltage @ I _{OL} = 2 mA	V _{OL}			0.5	V
RG and H-DRIVER OUTPUTS (H1–H4)					
High Level Output Voltage @ Max Current	V _{OH}	VDD – 0.5			V
Low Level Output Voltage @ Max Current	V _{OL}			0.5	V
Maximum Output Current (Programmable)		24			mA
Maximum Load Capacitance (for Each Output)		100			pF

Specifications subject to change without notice.

AD9891/AD9895

AD9891—ANALOG SPECIFICATIONS (AVDD1, AVDD2 = 3.0 V, $f_{\text{CLK}} = 20 \text{ MHz}$, T_{MIN} to T_{MAX} , unless otherwise noted.)

Parameter	Min	Typ	Max	Unit	Notes
CDS					
Gain		0		dB	Input signal characteristics*
Allowable CCD Reset Transient		500		mV	
Max Input Range before Saturation	1.0			V p-p	
Max CCD Black Pixel Amplitude		±200		mV	
PIXEL GAIN AMPLIFIER (PxGA)					
Max Input Range	1.0			V p-p	Default setting
Max Output Range	1.6			V p-p	
Gain Control Resolution		64		Steps	
Gain Monotonicity		Guaranteed			
Gain Range					
Min Gain (PxGA Code 32)		-2.5		dB	
Med Gain (PxGA Code 0)		+3.5		dB	
Max Gain (PxGA Code 31)		+9.5		dB	
VARIABLE GAIN AMPLIFIER (VGA)					
Max Input Range	1.6			V p-p	
Max Output Range	2.0			V p-p	
Gain Control Resolution		1024		Steps	
Gain Monotonicity		Guaranteed			
Gain Range					
Low Gain (VGA Code 70)		2		dB	
Max Gain (VGA Code 1023)		36		dB	
BLACK LEVEL CLAMP					
Clamp Level Resolution		256		Steps	Measured at ADC output
Clamp Level					
Min Clamp Level		0		LSB	
Max Clamp Level		63.75		LSB	
A/D CONVERTER					
Resolution	10			Bits	
Differential Nonlinearity (DNL)		±0.4	±1.0	LSB	
No Missing Codes		Guaranteed			
Full-Scale Input Voltage		2.0		V	
VOLTAGE REFERENCE					
Reference Top Voltage (VRT)		2.0		V	
Reference Bottom Voltage (VRB)		1.0		V	
SYSTEM PERFORMANCE					
Gain Accuracy					Includes entire signal chain Includes 4 dB default PxGA gain Gain = (0.035 × Code) + 3.55 dB 12 dB gain applied AC grounded input, 6 dB gain applied Measured with step change on supply
Low Gain (VGA Code 70)	5	6	7	dB	
Max Gain (VGA Code 1023)	38.5	39.5	40.5	dB	
Peak Nonlinearity, 500 mV Input Signal		0.2		%	
Total Output Noise		0.6		LSB rms	
Power Supply Rejection (PSR)		40		dB	

*Input signal characteristics defined as follows:

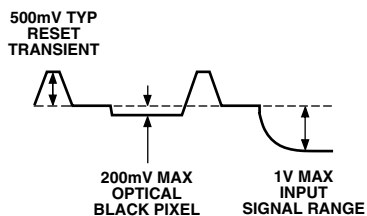

Specifications subject to change without notice.

AD9895—ANALOG SPECIFICATIONS (AVDD1, AVDD2 = 3.0 V, $f_{\text{CLK}} = 30 \text{ MHz}$, T_{MIN} to T_{MAX} , unless otherwise noted.)

Parameter	Min	Typ	Max	Unit	Notes
CDS					
Gain		0		dB	Input signal characteristics*
Allowable CCD Reset Transient		500		mV	
Max Input Range before Saturation	1.0			V p-p	
Max CCD Black Pixel Amplitude		±200		mV	
PIXEL GAIN AMPLIFIER (PxGA)					
Max Input Range	1.0			V p-p	Default setting
Max Output Range	1.6			V p-p	
Gain Control Resolution		64		Steps	
Gain Monotonicity		Guaranteed			
Gain Range					
Min Gain (PxGA Code 32)		-2.5		dB	
Med Gain (PxGA Code 0)		+3.5		dB	
Max Gain (PxGA Code 31)		+9.5		dB	
VARIABLE GAIN AMPLIFIER (VGA)					
Max Input Range	1.6			V p-p	
Max Output Range	2.0			V p-p	
Gain Control Resolution		1024		Steps	
Gain Monotonicity		Guaranteed			
Gain Range					
Low Gain (VGA Code 70)		2		dB	
Max Gain (VGA Code 1023)		36		dB	
BLACK LEVEL CLAMP					
Clamp Level Resolution		256		Steps	Measured at ADC output
Clamp Level					
Min Clamp Level		0		LSB	
Max Clamp Level		255		LSB	
A/D CONVERTER					
Resolution	12			Bits	
Differential Nonlinearity (DNL)		±0.5	±1.0	LSB	
No Missing Codes		Guaranteed			
Full-Scale Input Voltage		2.0		V	
VOLTAGE REFERENCE					
Reference Top Voltage (VRT)		2.0		V	
Reference Bottom Voltage (VRB)		1.0		V	
SYSTEM PERFORMANCE					
Gain Accuracy					Includes entire signal chain Includes 4 dB default PxGA gain Gain = (0.035 × Code) + 3.55 dB
Low Gain (VGA Code 70)	5	6	7	dB	
Max Gain (VGA Code 1023)	38.5	39.5	40.5	dB	
Peak Nonlinearity, 500 mV Input Signal		0.2		%	
Total Output Noise		0.8		LSB rms	
Power Supply Rejection (PSR)		40		dB	

*Input signal characteristics defined as follows:

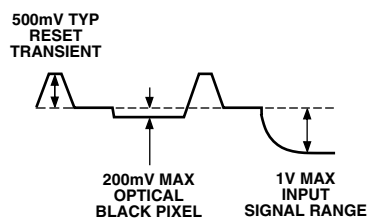

Specifications subject to change without notice.

AD9891/AD9895

TIMING SPECIFICATIONS ($C_L = 20$ pF, $AVDD = DVDD = DRVDD = 3.0$ V, $f_{CLI} = 20$ MHz [AD9891] or 30 MHz [AD9895], unless otherwise noted.)

Parameter	Symbol	Min	Typ	Max	Unit
MASTER CLOCK, CLI (Figure 7)					
CLI Clock Period, AD9891	t_{CONV}	50			ns
CLI High/Low Pulsewidth, AD9891		20	25		ns
CLI Clock Period, AD9895	t_{CONV}	33.3			ns
CLI High/Low Pulsewidth, AD9895		13	16.7		ns
Delay from CLI Rising Edge to Internal Pixel Position 0	t_{CLIDLy}		6		ns
AFE CLAMP PULSES ¹ (Figure 13)					
CLPDM Pulsewidth		4	10		Pixels
CLPOB Pulsewidth ²		2	20		Pixels
AFE SAMPLE LOCATION ¹ (Figure 10)					
SHP Sample Edge to SHD Sample Edge, AD9891	t_{S1}	20	25		ns
SHP Sample Edge to SHD Sample Edge, AD9895	t_{S1}	13	16.7		ns
DATA OUTPUTS (Figure 12)					
Output Delay from DCLK Rising Edge ¹	t_{OD}		8		ns
Pipeline Delay from SHP/SHD Sampling			9		Cycles
SERIAL INTERFACE (Figures 52 and 53)					
Maximum SCK Frequency	f_{SCLK}	10			MHz
SL to SCK Setup Time	t_{LS}	10			ns
SCK to SL Hold Time	t_{LH}	10			ns
SDATA Valid to SCK Rising Edge Setup	t_{DS}	10			ns
SCK Falling Edge to SDATA Valid Hold	t_{DH}	10			ns
SCK Falling Edge to SDATA Valid Read	t_{DV}	10			ns

NOTES

¹Parameter is programmable.

²Minimum CLPOB pulsewidth is for functional operation only. Wider typical pulses are recommended to achieve good clamp performance.

ABSOLUTE MAXIMUM RATINGS

Parameter	With Respect To	Min Max		Unit
		Min	Max	
AVDD1, AVDD2	AVSS	-0.3	+3.9	V
TCVDD	TCVSS	-0.3	+3.9	V
HVDD	HVSS	-0.3	+5.5	V
RGVDD	RGVSS	-0.3	+5.5	V
DVDD	DVSS	-0.3	+3.9	V
DRVDD	DRVSS	-0.3	+3.9	V
RG Output	RGVSS	-0.3	RGVDD + 0.3	V
H1-H4 Output	HVSS	-0.3	HVDD + 0.3	V
Digital Outputs	DVSS	-0.3	DVDD + 0.3	V
Digital Inputs	DVSS	-0.3	DVDD + 0.3	V
SCK, SL, SDATA	DVSS	-0.3	DVDD + 0.3	V
VRT, VRB	AVSS	-0.3	AVDD + 0.3	V
BYP1-BYP3, CCDIN	AVSS	-0.3	AVDD + 0.3	V
Junction Temperature			150	°C
Lead Temperature, 10 sec			350	°C

PACKAGE THERMAL CHARACTERISTICS

Thermal Resistance

$$\theta_{JA} = 61^{\circ}\text{C/W}$$

$$\theta_{JC} = 29.7^{\circ}\text{C/W}$$

ORDERING GUIDE

Model	Temperature Range	Package Description	Package Option
AD9891KBC	-20°C to +85°C	CSPBGA	BC-64
AD9895KBC	-20°C to +85°C	CSPBGA	BC-64

CAUTION

ESD (electrostatic discharge) sensitive device. Electrostatic charges as high as 4000 V readily accumulate on the human body and test equipment and can discharge without detection. Although the AD9891 and AD9895 feature proprietary ESD protection circuitry, permanent damage may occur on devices subjected to high energy electrostatic discharges. Therefore, proper ESD precautions are recommended to avoid performance degradation or loss of functionality.



AD9891 PIN CONFIGURATION

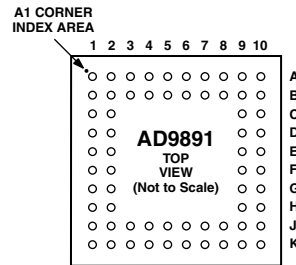

PIN FUNCTION DESCRIPTIONS¹

Pin	Mnemonic	Type ²	Description	Pin	Mnemonic	Type ²	Description
A1	VD	DO	Vertical Sync Pulse (Input for Slave Mode, Output for Master Mode)	K9	VSG5	DO	CCD Sensor Gate Pulse 5
B1	HD	DO	Horizontal Sync Pulse (Input for Slave Mode, Output for Master Mode)	J9	VSG6	DO	CCD Sensor Gate Pulse 6
C1	SYNC	DI	External System Sync Input	K10	VSG7	DO	CCD Sensor Gate Pulse 7
C2	LD/FD	DO	Line or Field Designator Output	J10	VSG8	DO	CCD Sensor Gate Pulse 8
D1	DCLK	DO	Data Clock Output	H10	H1	DO	CCD Horizontal Clock 1
D2	CLPOB/ PBLK	DO	CLPOB or PBLK Output	H9	H2	DO	CCD Horizontal Clock 2
E1	NC		Not Internally Connected	G10	HVDD	P	H1–H4 Driver Supply
E2	NC		Not Internally Connected	G9	HVSS	P	H1–H4 Driver Ground
F2	DO/SDO	DO	Data Output (LSB) (also Serial Data Output ³)	F10	H3	DO	CCD Horizontal Clock 3
F1	D1	DO	Data Output	F9	H4	DO	CCD Horizontal Clock 4
G2	D2	DO	Data Output	E10	RGVDD	P	RG Driver Supply
G1	D3	DO	Data Output	E9	RGVSS	P	RG Driver Ground
H2	D4	DO	Data Output	D9	RG	DO	CCD Reset Gate Clock
H1	D5	DO	Data Output	D10	CLO	DO	Reference Clock Output for Crystal
J2	D6	DO	Data Output	C10	CLI	DI	Reference Clock Input
J1	D7	DO	Data Output	B10	TCVDD	P	Analog Supply for Timing Core
K2	D8	DO	Data Output	C9	TCVSS	P	Analog Ground for Timing Core
K1	D9	DO	Data Output (MSB)	A10	AVDD1	P	Analog Supply for AFE
K3	DRVDD	P	Data Output Driver Supply	B9	AVSS1	P	Analog Ground for AFE
K4	DRVSS	P	Data Output Driver Ground	A9	BYP1	AO	Analog Circuit Bypass
J3	VSUB	DO	CCD Substrate Bias	B8	BYP2	AO	Analog Circuit Bypass
J4	SUBCK	DO	CCD Substrate Clock (E-Shutter)	A8	CCDIN	AI	CCD Signal Input
K5	V1	DO	CCD Vertical Transfer Clock 1	A7	BYP3	AO	Analog Circuit Bypass
J5	V2	DO	CCD Vertical Transfer Clock 2	B7	AVDD2	P	Analog Supply for AFE
K6	V3	DO	CCD Vertical Transfer Clock 3	B6	AVSS2	P	Analog Ground for AFE
J6	V4	DO	CCD Vertical Transfer Clock 4	A6	REFB	AO	Voltage Reference Bottom Bypass
K7	VSG1/V5	DO	CCD Sensor Gate Pulse 1 (also V5 ⁴)	A5	REFT	AO	Voltage Reference Top Bypass
J7	VSG2/V6	DO	CCD Sensor Gate Pulse 2 (also V6 ⁴)	B5	SL	DI	3-Wire Serial Load Pulse
K8	VSG3/V7	DO	CCD Sensor Gate Pulse 3 (also V7 ⁴)	A4	SDI	DI	3-Wire Serial Data Input
J8	VSG4/V8	DO	CCD Sensor Gate Pulse 4 (also V8 ⁴)	B4	SCK	DI	3-Wire Serial Clock
				A3	MSHUT	DO	Mechanical Shutter Pulse
				B3	STROBE	DO	Strobe Pulse
				B2	DVSS	P	Digital Ground
				A2	DVDD	P	Digital Supply for VSG, V1–V4, HD, VD, MSHUT, STROBE, and Serial Interface

NOTES

¹See Figure 50 for circuit configuration.

²AI = Analog Input, AO = Analog Output, DI = Digital Input,
DO = Digital Output, DIO = Digital Input/Output, P = Power.

³In Register Readback Mode

⁴In Frame Transfer CCD Mode

AD9895 PIN CONFIGURATION

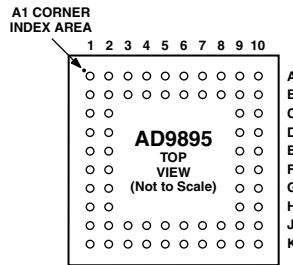

PIN FUNCTION DESCRIPTIONS¹

Pin	Mnemonic	Type ²	Description	Pin	Mnemonic	Type ²	Description
A1	VD	DO	Vertical Sync Pulse (Input for Slave Mode, Output for Master Mode)	K9	VSG5	DO	CCD Sensor Gate Pulse 5
B1	HD	DO	Horizontal Sync Pulse (Input for Slave Mode, Output for Master Mode)	J9	VSG6	DO	CCD Sensor Gate Pulse 6
C1	SYNC	DI	External System Sync Input	K10	VSG7	DO	CCD Sensor Gate Pulse 7
C2	LD/FD	DO	Line or Field Designator Output	J10	VSG8	DO	CCD Sensor Gate Pulse 8
D1	DCLK	DO	Data Clock Output	H10	H1	DO	CCD Horizontal Clock 1
D2	CLPOB/ PBLK	DO	CLPOB or PBLK Output	H9	H2	DO	CCD Horizontal Clock 2
E2	DO	DO	Data Output (LSB)	G10	HVDD	P	H1–H4 Driver Supply
E1	D1	DO	Data Output	G9	HVSS	P	H1–H4 Driver Ground
F2	D2/SDO	DO	Data Output (also Serial Data Output ³)	F10	H3	DO	CCD Horizontal Clock 3
F1	D3	DO	Data Output	F9	H4	DO	CCD Horizontal Clock 4
G2	D4	DO	Data Output	E10	RGVDD	P	RG Driver Supply
G1	D5	DO	Data Output	E9	RGVSS	P	RG Driver Ground
H2	D6	DO	Data Output	D9	RG	DO	CCD Reset Gate Clock
H1	D7	DO	Data Output	D10	CLO	DO	Reference Clock Output for Crystal
J2	D8	DO	Data Output	C10	CLI	DI	Reference Clock Input
J1	D9	DO	Data Output	B10	TCVDD	P	Analog Supply for Timing Core
K2	D10	DO	Data Output	C9	TCVSS	P	Analog Ground for Timing Core
K1	D11	DO	Data Output (MSB)	A10	AVDD1	P	Analog Supply for AFE
K3	DRVDD	P	Data Output Driver Supply	B9	AVSS1	P	Analog Ground for AFE
K4	DRVSS	P	Data Output Driver Ground	A9	BYP1	AO	Analog Circuit Bypass
J3	VSUB	DO	CCD Substrate Bias	B8	BYP2	AO	Analog Circuit Bypass
J4	SUBCK	DO	CCD Substrate Clock (E-Shutter)	A8	CCDIN	AI	CCD Signal Input
K5	V1	DO	CCD Vertical Transfer Clock 1	A7	BYP3	AO	Analog Circuit Bypass
J5	V2	DO	CCD Vertical Transfer Clock 2	B7	AVDD2	P	Analog Supply for AFE
K6	V3	DO	CCD Vertical Transfer Clock 3	B6	AVSS2	P	Analog Ground for AFE
J6	V4	DO	CCD Vertical Transfer Clock 4	A6	REFB	AO	Voltage Reference Bottom Bypass
K7	VSG1/V5	DO	CCD Sensor Gate Pulse 1 (also V5 ⁴)	A5	REFT	AO	Voltage Reference Top Bypass
J7	VSG2/V6	DO	CCD Sensor Gate Pulse 2 (also V6 ⁴)	B5	SL	DI	3-Wire Serial Load Pulse
K8	VSG3/V7	DO	CCD Sensor Gate Pulse 3 (also V7 ⁴)	A4	SDI	DI	3-Wire Serial Data Input
J8	VSG4/V8	DO	CCD Sensor Gate Pulse 4 (also V8 ⁴)	B4	SCK	DI	3-Wire Serial Clock
				A3	MSHUT	DO	Mechanical Shutter Pulse
				B3	STROBE	DO	Strobe Pulse
				B2	DVSS	P	Digital Ground
				A2	DVDD	P	Digital Supply for VSG, V1–V4, HD, VD, MSHUT, STROBE, and Serial Interface

NOTES

¹See Figure 50 for circuit configuration.

²AI = Analog Input, AO = Analog Output, DI = Digital Input, DO = Digital Output, DIO = Digital Input/Output, P = Power.

³In Register Readback Mode

⁴In Frame Transfer CCD Mode

AD9891/AD9895—Typical Performance Characteristics

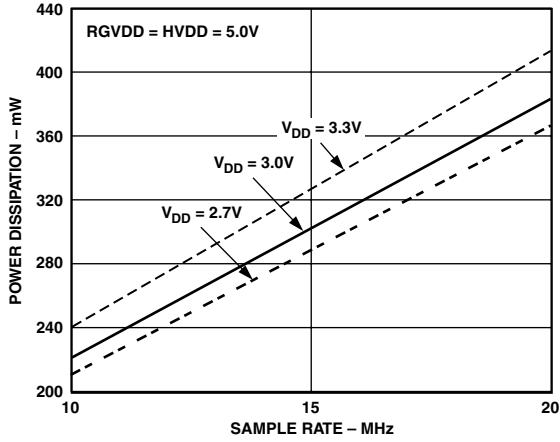

TPC 1. AD9891 Power vs. Sample Rate

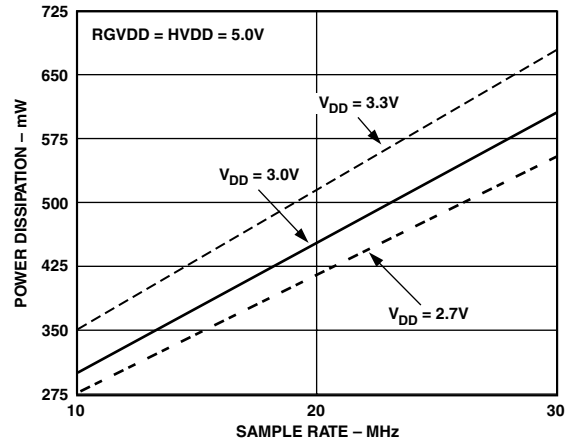

TPC 4. AD9895 Power vs. Sample Rate

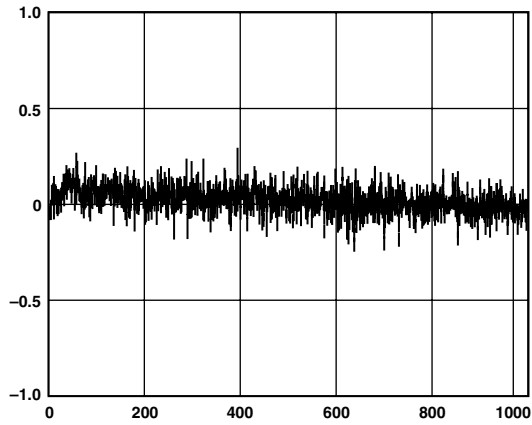

TPC 2. AD9891 Typical DNL Performance

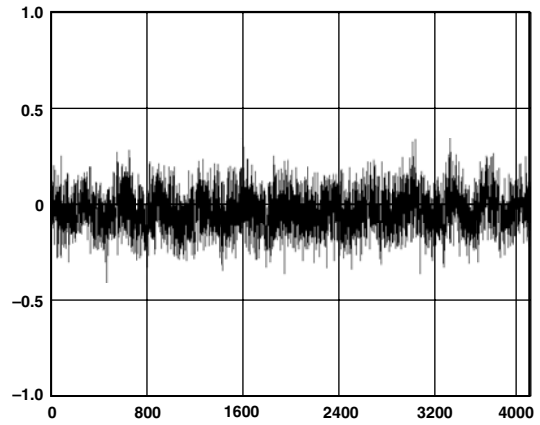

TPC 5. AD9895 Typical DNL Performance

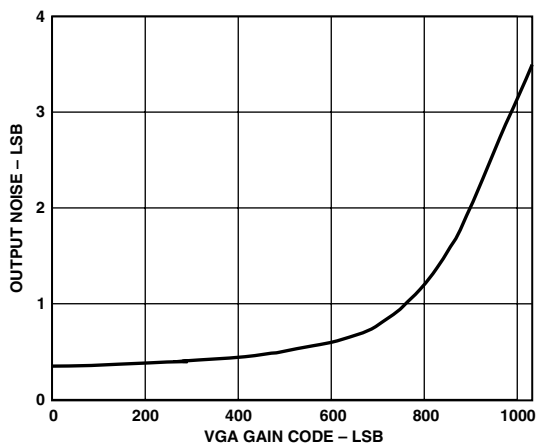

TPC 3. AD9891 Output Noise vs. VGA Gain

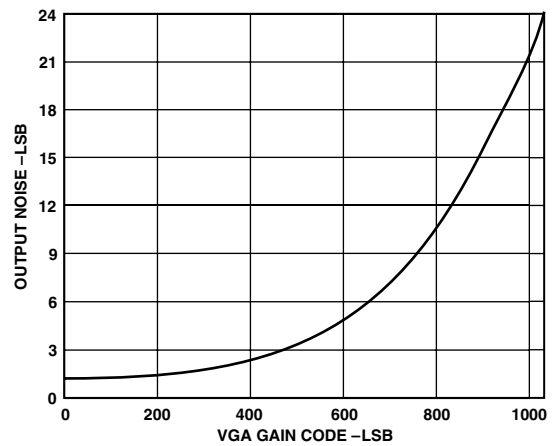

TPC 6. AD9895 Output Noise vs. VGA Gain

SYSTEM OVERVIEW

Figure 5 shows the typical system block diagram for the AD9891/AD9895 used in Master Mode. The CCD output is processed by the AD9891/AD9895's AFE circuitry, which consists of a CDS, P_xGA , VGA, black level clamp, and an A/D converter. The digitized pixel information is sent to the digital image processor chip, which performs the post-processing and compression. To operate the CCD, all CCD timing parameters are programmed into the AD9891/AD9895 from the system microprocessor, through the 3-wire serial interface. From the system master clock, CLI, provided by the image processor or external crystal, the AD9891/AD9895 generates all of the CCD's horizontal and vertical clocks and all internal AFE clocks. External synchronization is provided by a SYNC pulse from the microprocessor, which will reset internal counters and resync the VD and HD outputs.

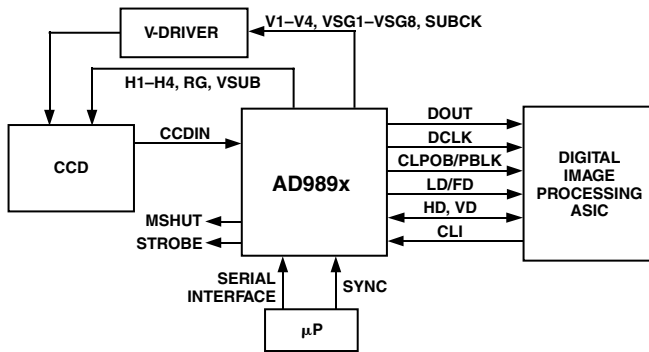

Figure 5. Typical System Block Diagram, Master Mode

Alternatively, the AD9891/AD9895 may be operated in Slave Mode, in which the VD and HD are provided externally from the image processor. In this mode, all AD9891/AD9895 timing will be synchronized with VD and HD.

The H-drivers for H1–H4 and RG are included in the AD9891/AD9895, allowing these clocks to be directly connected to the CCD. H-drive voltage of up to 5 V is supported. An external V-driver is required for the vertical transfer clocks, the sensor gate pulses, and the substrate clock.

The AD9891/AD9895 also includes programmable MSHUT and STROBE outputs, which may be used to trigger mechanical shutter and strobe (flash) circuitry.

Figure 6 shows the horizontal and vertical counter dimensions for the AD9891/AD9895. All internal horizontal and vertical clocking is programmed using these dimensions to specify line and pixel locations.

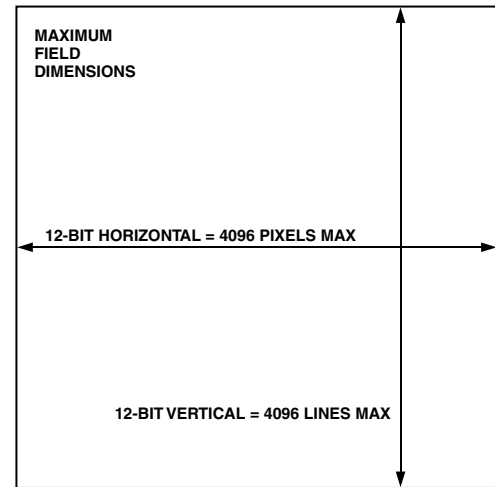

Figure 6. Vertical and Horizontal Counters

AD9891/AD9895

PRECISION TIMING HIGH SPEED TIMING GENERATION

The AD9891/AD9895 generates flexible, high speed timing signals using the *Precision Timing* core. This core is the foundation for generating the timing used for both the CCD and the AFE: the reset gate RG, horizontal drivers H1–H4, and the SHP/SHD sample clocks. A unique architecture makes it routine for the system designer to optimize image quality by providing precise control over the horizontal CCD readout and the AFE correlated double sampling.

The high speed timing of the AD9891/AD9895 operates the same in either Master or Slave Mode configuration.

Timing Resolution

The *Precision Timing* core uses a $1\times$ master clock input (CLI) as a reference. This clock should be the same as the CCD pixel clock frequency. Figure 7 illustrates how the internal timing core divides the master clock period into 48 steps or edge positions. Using a 20 MHz CLI frequency, the edge resolution of the *Precision Timing* core is 1 ns. If a $1\times$ system clock is not available, it is also possible to use a $2\times$ reference clock by programming the CLIDIVIDE Register (Addr x01F). The AD9891/AD9895 will then internally divide the CLI frequency by two.

The AD9891/AD9895 also includes a master clock output, CLO, which is the inverse of CLI. This output is intended to be used as a crystal driver. A crystal can be placed between the CLI and CLO Pins to generate the master clock for the AD9891/AD9895. For more information on using a crystal, see Figure 51.

High Speed Clock Programmability

Figure 8 shows how the high speed clocks RG, H1–H4, SHP, and SHD are generated. The RG pulse has programmable rising and falling edges, and may be inverted using the polarity control. The horizontal clocks H1 and H3 have programmable rising and falling edges and polarity control. The H2 and H4 clocks are always inverses of H1 and H3, respectively. Table I summarizes the high speed timing registers and their parameters. Figure 9 shows the typical 2-phase H-clock arrangement in which H3 and H4 are programmed for the same edge location as H1 and H2.

The edge location registers are six bits wide, but there are only 48 valid edge locations available. Therefore, the register values are mapped into four quadrants, with each quadrant containing 12 edge locations. Table II shows the correct register values for

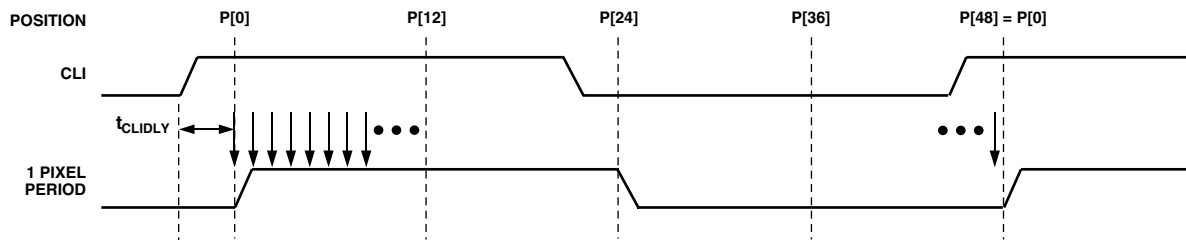

NOTES
 PIXEL CLOCK PERIOD IS DIVIDED INTO 48 POSITIONS, PROVIDING FINE EDGE RESOLUTION FOR HIGH SPEED CLOCKS.
 THERE IS A FIXED DELAY FROM THE CLI INPUT TO THE INTERNAL PIXEL PERIOD POSITIONS ($t_{CLIDLAY} = 6\text{ns TYP}$).

Figure 7. High Speed Clock Resolution from CLI Master Clock Input

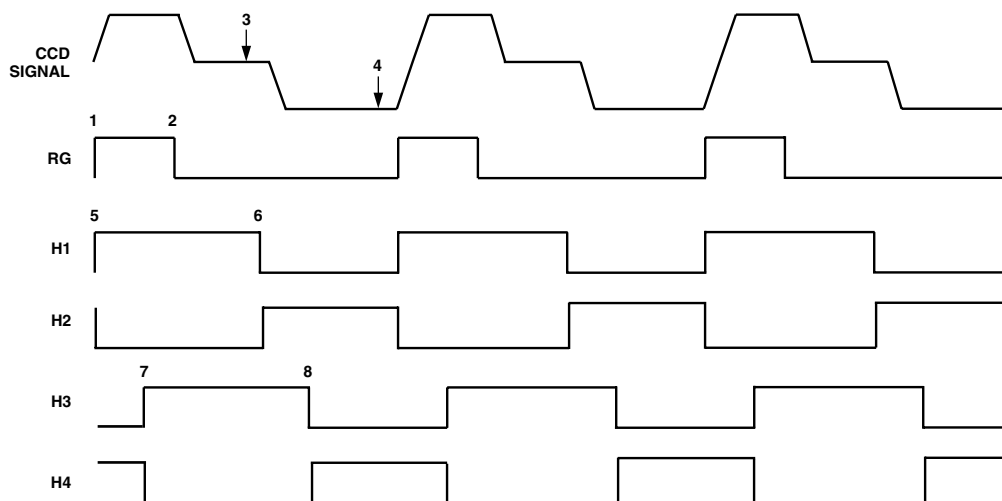

PROGRAMMABLE CLOCK POSITIONS:
 1: RG RISING EDGE
 2: RG FALLING EDGE
 3: SHP SAMPLE LOCATION
 4: SHD SAMPLE LOCATION
 5: H1 RISING EDGE POSITION AND 6: H1 FALLING EDGE POSITION (H2 IS INVERSE OF H1)
 7: H3 RISING EDGE POSITION AND 8: H3 FALLING EDGE POSITION (H4 IS INVERSE OF H3)

Figure 8. High Speed Clock Programmable Locations

the corresponding edge locations. Figure 10 shows the range and default locations of the high speed clock signals.

H-Driver and RG Outputs

In addition to the programmable timing positions, the AD9891/AD9895 features on-chip output drivers for the RG and H1–H4 outputs. These drivers are powerful enough to directly drive the CCD inputs. The H-driver current can be adjusted for optimum rise/fall time into a particular load by using the DRV Registers (Addr x0E1 to x0E4). The RG drive current is adjustable using the RGDRV Register (Addr x0E8). Each 3-bit DRV Register is adjustable in 3.5 mA increments, with the minimum setting of 0 equal to OFF or three-state, and the maximum setting of 7 equal to 24.5 mA.

As shown in Figure 11, the H2 and H4 outputs are inverses of H1 and H3, respectively. The internal propagation delay resulting from the signal inversion is less than 1 ns, which is significantly less than the typical rise time driving the CCD load. This results

in an H1/H2 crossover voltage at approximately 50% of the output swing. The crossover voltage is not programmable.

Digital Data Outputs

The AD9891/AD9895 data output and DCLK phase are programmable using the DOUTPHASE Register (Addr x01D). Any edge from 0 to 47 may be programmed, as shown in Figure 12. Normally, the DOUT and DCLK signals will track in phase, based on the DOUTPHASE Register contents. The DCLK output phase can also be held fixed with respect to the data outputs, by changing the DCLKMODE Register (Addr x01E) HIGH. In this mode, the DCLK output will remain at a fixed phase equal to CLO (the inverse of CLI) while the data output phase is still programmable.

There is a fixed output delay from the DCLK rising edge to the DOUT transition, called t_{OD} . This delay can be programmed to four values between 0 ns and 12 ns, using the DOUT_DELAY Register (Addr x032). The default value is 8 ns.

Table I. H1–H4, RG, SHP, and SHD Timing Parameters

Register	Length	Range	Description
POL	1b	High/Low	Polarity Control for H1, H3, and RG (0 = No Inversion, 1 = Inversion)
POSLOC	6b	0–47 Edge Location	Positive Edge Location for H1, H3, and RG Sample Location for SHP, SHD
NEGLOC	6b	0–47 Edge Location	Negative Edge Location for H1, H3, and RG
DRV	3b	0–7 Current Steps	Drive Current for H1–H4 and RG Outputs (3.5 mA per Step)

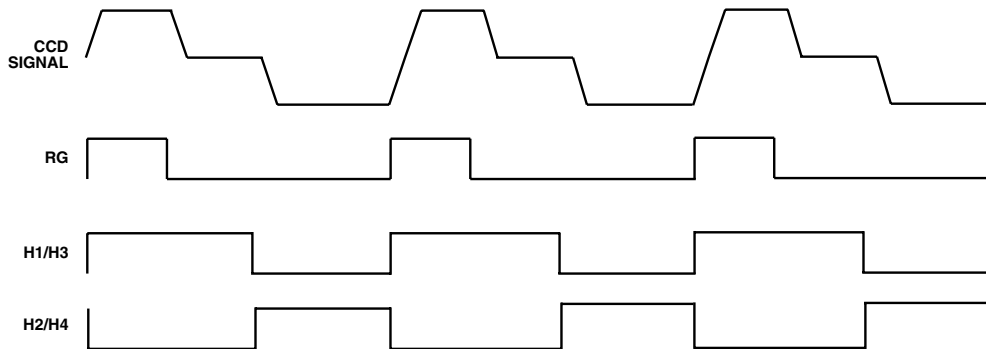

USING THE SAME TOGGLE POSITIONS FOR H1 AND H3 GENERATES STANDARD 2-PHASE H-CLOCKING.

Figure 9. 2-Phase H-Clock Operation

Table II. Precision Timing Edge Locations

Quadrant	Edge Location (Dec)	Register Value (Dec)	Register Value (Bin)
I	0 to 11	0 to 11	000000 to 001011
II	12 to 23	16 to 27	010000 to 011011
III	24 to 35	32 to 43	100000 to 101011
IV	36 to 47	48 to 59	110000 to 111011

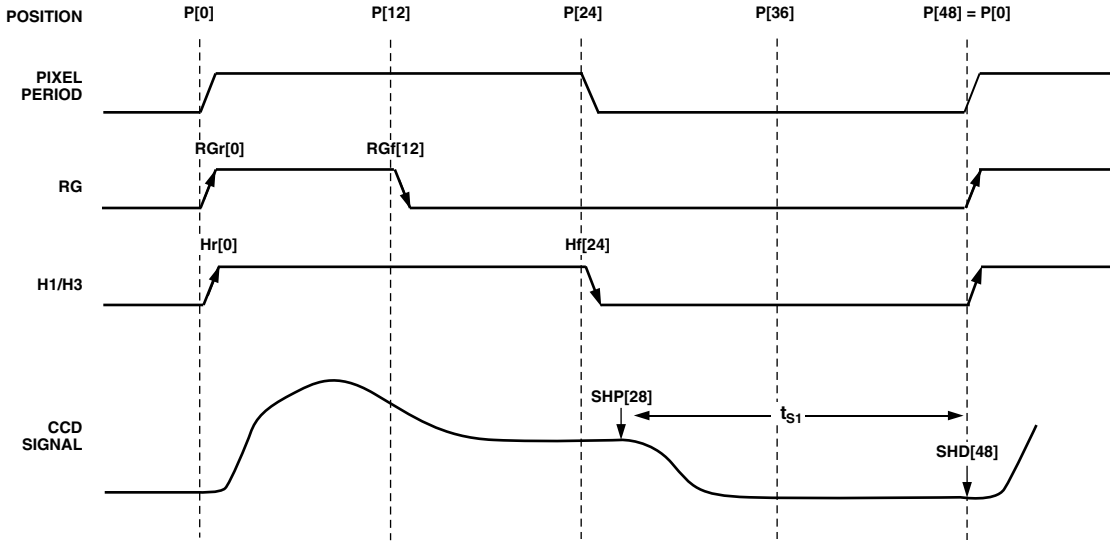

NOTES
 ALL SIGNAL EDGES ARE FULLY PROGRAMMABLE TO ANY OF THE 48 POSITIONS WITHIN ONE PIXEL PERIOD.
 DEFAULT POSITIONS FOR EACH SIGNAL ARE SHOWN.

Figure 10. High Speed Clock Default and Programmable Locations

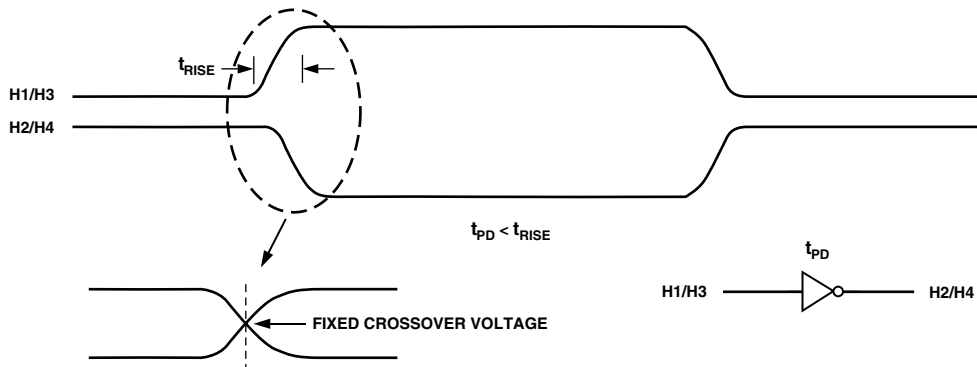
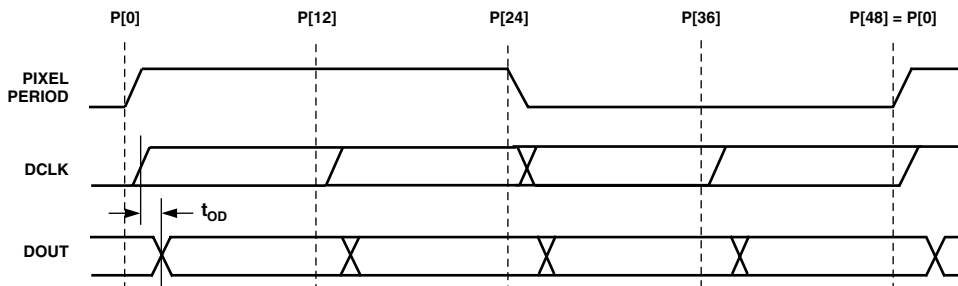

Figure 11. H-Clock Inverse Phase Relationship



NOTES
 DATA OUTPUT (DOUT) AND DCLK PHASE ARE ADJUSTABLE WITH RESPECT TO THE PIXEL PERIOD.
 WITHIN 1 CLOCK PERIOD, THE DATA TRANSITION CAN BE PROGRAMMED TO 48 DIFFERENT LOCATIONS.
 OUTPUT DELAY (t_{OD}) FROM DCLK RISING EDGE TO DOUT RISING EDGE IS PROGRAMMABLE.

Figure 12. Digital Output Phase Adjustment

HORIZONTAL CLAMPING AND BLANKING

The AD9891/AD9895's horizontal clamping and blanking pulses are fully programmable to suit a variety of applications. As with the vertical timing generation, individual sequences are defined for each signal, which are then organized into multiple regions during image readout. This allows the dark pixel clamping and blanking patterns to be changed at each stage of the readout in order to accommodate different image transfer timing and high speed line shifts.

Individual CLPOB, CLPDM, and PBLK Sequences

The AFE horizontal timing consists of CLPOB, CLPDM, and PBLK, as shown in Figure 13. These three signals are independently programmed using the registers in Table III. SPOL is the start polarity for the signal, and TOG1 and TOG2 are the first and second toggle positions of the pulse. All three signals are active low and should be programmed accordingly. Up to four individual sequences can be created for each signal.

To simplify the programming requirements, the CLPDM signal will track the CLPOB signal by default. If separate control of the CLPDM signal is desired, the SINGLE_CLAMP Register (Addr x031) should be set LOW.

Individual HBLK Sequences

The HBLK programmable timing shown in Figure 14 is similar to CLPOB, CLPDM, and PBLK. However, there is no start polarity control. Only the toggle positions are used to designate the start and the stop positions of the blanking period. Additionally, there is a polarity control, HBLKMASK, that designates the polarity of the horizontal clock signals H1–H4 during the blanking period. Setting HBLKMASK high will set H1 = H3 = Low and H2 = H4 = High during the blanking, as shown in Figure 15. Up to four individual sequences are available for HBLK.

Horizontal Sequence Control

The AD9891/AD9895 use sequence change positions (SCP) and sequence pointers (SPTR) to organize the individual hori-

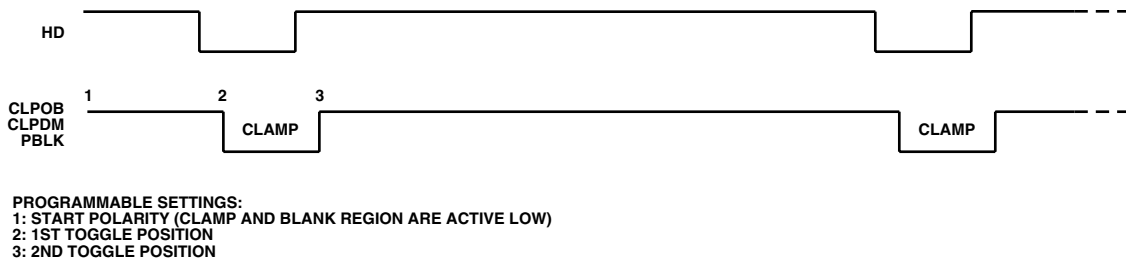

Figure 13. Clamp and Preblank Pulse Placement

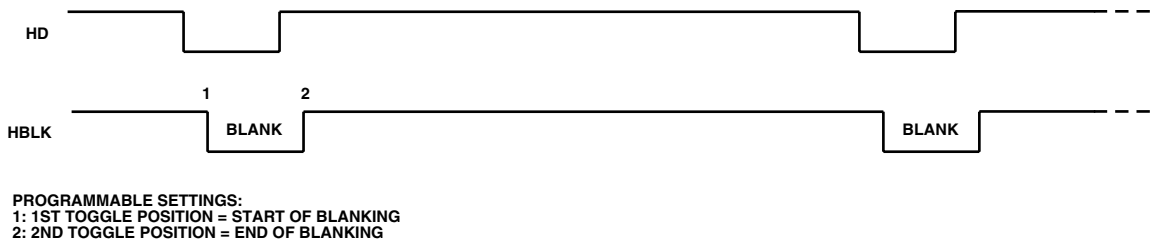
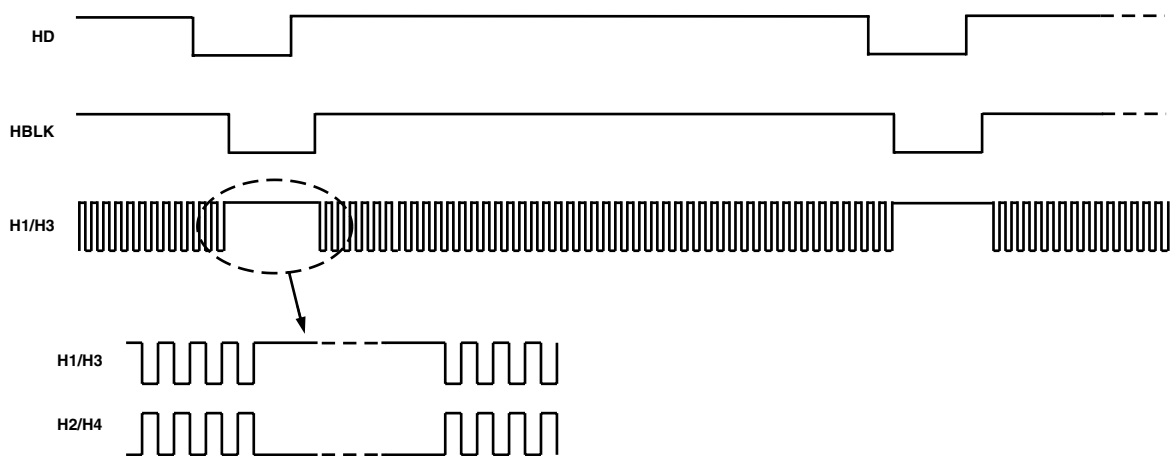

Figure 14. Horizontal Blanking (HBLK) Pulse Placement



THE POLARITY OF H1 DURING BLANKING IS PROGRAMMABLE (H2 IS OPPOSITE POLARITY OF H1)

Figure 15. HBLK Masking Control

AD9891/AD9895

zontal sequences. Up to four SCPs are available to divide the readout into four separate regions, as shown in Figure 16. The SCP0 is always hard-coded to line 0, and SCP1–SCP3 are register programmable. During each region bound by the SCP, the SPTR Registers designate which sequence is used by each signal. CLPOB and CLPDM share the same SCP, PBLK has a separate set of SCP, and HBLK shares the vertical RCP (see Vertical Timing Generation section). For example,

CLPSCP1 will define Region 0 for CLPOB and CLPDM, and in that region any of the four individual CLPOB and CLPDM sequences may be selected with the SPTR Registers. The next SCP defines a new region, and in that region each signal can be assigned to a different individual sequence. Because HBLK shares the vertical RCP, there are up to eight regions where HBLK sequences may be changed using the eight HBLKSPTR Registers.

Table III. CLPOB, CLPDM, and PBLK Individual Sequence Parameters

Register	Length	Range	Description
SPOL	1b	High/Low	Starting Polarity of Vertical Transfer Pulse for Sequences 0–3
TOG1	12b	0–4095 Pixel Location	First Toggle Position within Line for Sequences 0–3
TOG2	12b	0–4095 Pixel Location	Second Toggle Position within Line for Sequences 0–3

Table IV. HBLK Individual Sequence Parameters

Register	Length	Range	Description
HBLKMASK	1b	High/Low	Masking Polarity for H1 for Sequences 0–3 (0 = H1 Low, 1 = H1 High)
HBLKTOG1	12b	0–4095 Pixel Location	First Toggle Position within Line for Sequences 0–3
HBLKTOG2	12b	0–4095 Pixel Location	Second Toggle Position within Line for Sequences 0–3

Table V. Horizontal Sequence Control Parameters for CLPOB, CLPDM, and PBLK

Register	Length	Range	Description
SCP1–SCP3	12b	0–4095 Line Number	CLPOB/PBLK SCP to Define Horizontal Regions 0–3
SPTR0–SPTR3	2b	0–3 Sequence Number	Sequence Pointer for Horizontal Regions 0–3

Table VI. Horizontal Sequence Control Parameters for HBLK

Register	Length	Range	Description
VTPRCP1–VTPRCP7	12b	0–4095 Line Number	Vertical Region Change Positions (See Table IX.)
HBLKSPTR0–HBLKSPTR7	2b	0–3 Sequence Number	Sequence Pointer for HBLK Regions 0–7

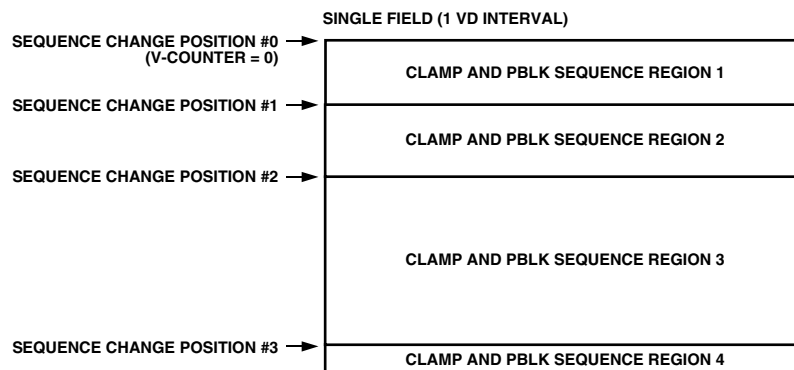

UP TO FOUR INDIVIDUAL HORIZONTAL CLAMP AND BLANKING REGIONS MAY BE PROGRAMMED WITHIN A SINGLE FIELD, USING THE SEQUENCE CHANGE POSITIONS.

Figure 16. Clamp and Blanking Sequence Flexibility

VERTICAL TIMING GENERATION

The AD9891/AD9895 provide a very flexible solution for generating vertical CCD timing and can support multiple CCDs and different system architectures. The 4-phase vertical transfer clocks V1–V4 are used to shift each line of pixels into the horizontal output register of the CCD. The AD9891/AD9895 allow these outputs to be individually programmed into different pulse patterns. Vertical sequence control registers then organize the individual vertical pulses into the desired CCD vertical timing arrangement.

Figure 17 shows an overview of how the vertical timing is generated in three basic steps. First, the individual pulse patterns or

sequences are created by using the Vertical Transfer Pulse (VTP) Registers. These sequences are essentially a “pool” of pulse patterns that may be assigned to any of the V1–V4 outputs. Second, individual regions are built by assigning a sequence to each of the V1–V4 outputs. Up to five unique regions may be specified. Finally, the readout of the entire field is constructed by combining one or more of the individual regions sequentially. With up to eight region areas available, different steps of the readout such as high speed line shifts and vertical image transfer can be supported.

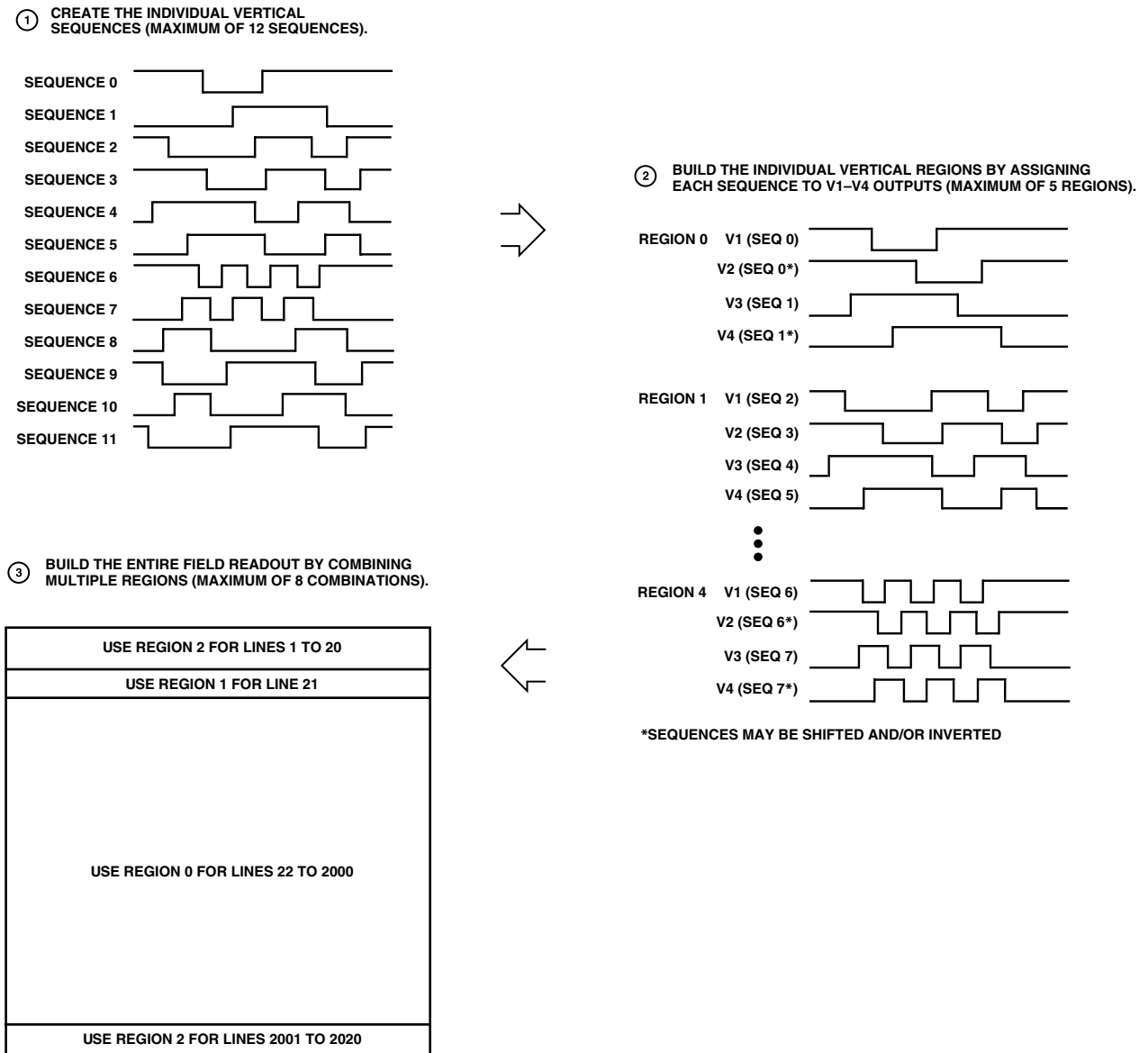

Figure 17. Summary of Vertical Timing Generation

AD9891/AD9895

Individual Vertical Sequences

To generate the individual vertical sequences or patterns shown in Figure 18, five registers are required for each sequence. Table VII summarizes these registers and their respective bit lengths. The start polarity (VTPPOL) determines the starting polarity of the vertical sequence and can be programmed high or low. The first toggle position (VTPTOG1) and second toggle position (VTPTOG2) are the pixel locations within the line where the pulse transitions. A third toggle position (VTPTOG3) is also available for sequences 0 through 7. All toggle positions are 10-bit values, which limits the placement of a pulse to within 1024 pixels of a line. A separate register, VSTART, sets the start position of the sequence within the line (see Individual Vertical Regions section). The Length (VTPLEN) Register determines the number of pixels between each of the pulse repetitions, if any repetitions have been programmed. The number of repetitions (VTPREP) simply determines the number of pulse repetitions desired within a

single line. Programming “1” for VTPREP gives a single pulse, while setting to “0” will provide a fixed dc output based on the start polarity value. There is a total of 12 individual sequences that may be programmed.

When specifying the individual regions, each sequence may be assigned to any of the V1–V4 outputs. For example, Figure 19 shows a typical 4-phase V-clock arrangement. Two different sequences are needed to generate the different pulsewidths. The use of individual start positions for V1–V4 allows the four outputs to be generated from two sequences. Figure 20 shows a slightly different V-clock arrangement in which V2, V3, and V4 are simply shifted and/or inverted versions of V1. Only one individual sequence is needed because all signals have the same pulsewidth. The invert sequence registers (VINV) are used for V3 and V4 (see Table VII).

Note that for added flexibility, the VTPPOL Registers (Start Polarity) may be used as an extra toggle position.

Table VII. Individual VTP Sequence Parameters

Register	Length	Range	Description
VTPPOL	1b	High/Low	Starting Polarity of Vertical Transfer Pulse for Each Sequence 0–11
VTPTOG1	10b	0–1023 Pixel Location	First Toggle Position within Line for Each Sequence 0–11
VTPTOG2	10b	0–1023 Pixel Location	Second Toggle Position within Line for Each Sequence 0–11
VTPTOG3	10b	0–1023 Pixel Location	Third Toggle Position within Line for Each Sequence 0–7
VTPLEN	10b	0–1023 Pixels	Length between Pulse Repetitions for Each Sequence 0–11
VTPREP	12b	0–4095 Pulses	Number of Pulse Repetitions for Each Sequence 0–11 (0 = DC Output)

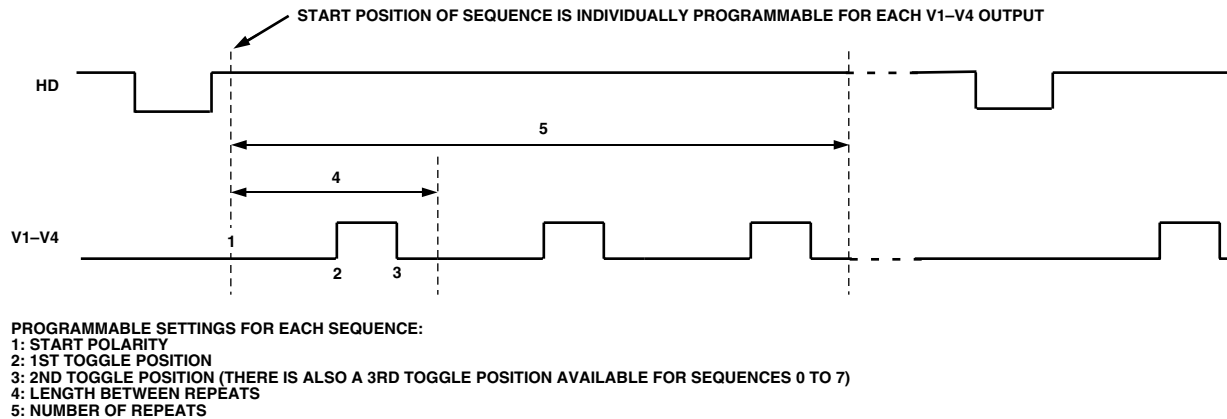

Figure 18. Individual Vertical Sequence Programmability

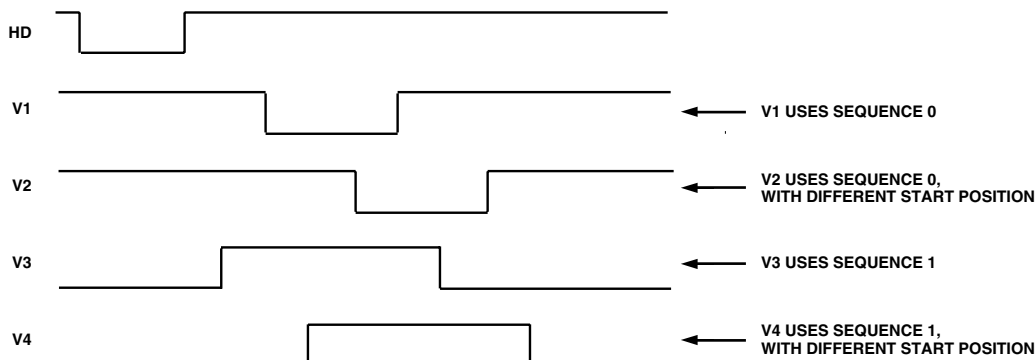

Figure 19. Example of Separate V1–V4 Signals Using Two Individual Sequences

Individual Vertical Regions

The AD9891/AD9895 arranges the individual sequences into regions through the use of Sequence Pointers (SPTR). Within each region, different sequences may be assigned to each V-clock output. Figure 21 shows the programmability of each region and Table VIII summarizes the registers needed for generating each region.

For each individual region, the line length (in pixels) is programmable using the HDLEN Registers. Each region can have a different line length to accommodate various image readout techniques. The maximum number of pixels per line is 4096. Also unique to each region are the sequence start positions for each V-output, which are programmed using the VSTART Registers. Each VSTART is a 12-bit value, allowing the start position to be placed anywhere in the line. There are five HDLEN Registers, one for each region. There is a total of 20 VSTART Registers: one for each V1–V4 output, for five different regions.

Note that the last line of the field is separately programmable using the HDLASTLEN Register.

The Sequence Pointer registers VxSPTRFIRST and VxSPTRSECOND assign the individual vertical sequences to each of the V-clock outputs (V1–V4) within a given region. Typically, only the SPTRFIRST Registers are used, with the SPTRSECOND Registers reserved for generating line-by-line alternation (see Vertical Sequence Alternation). Any of the 12 individual sequences may also be inverted using the VxINVFIRST and VxINVSECOND Registers, effectively doubling the number of sequences available. There is one SPTRFIRST Register for each V-output, for a total of four registers per region. If all five regions are used, there is a total of 20 SPTRFIRST Registers. There is also the same number of SPTRSECOND Registers, if alternation is required. Note that the SPTR Registers are four bits wide; if a value greater than 11 is programmed, the Vx output will be dc at the level of the VxINV Register.

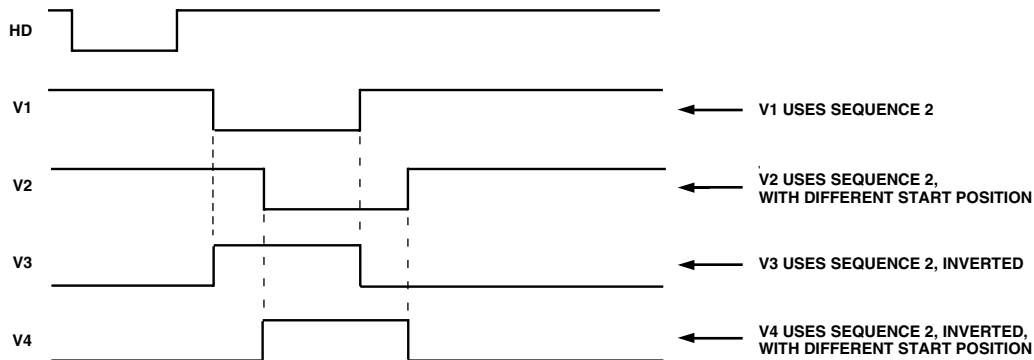
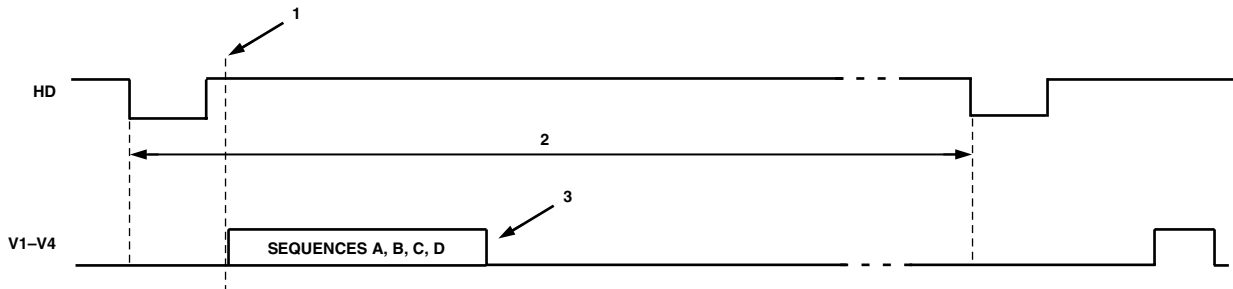

Figure 20. Example of Inverted V1–V4 Signals Using One Individual Sequence with Inversion



PROGRAMMABLE SETTINGS FOR EACH REGION:
 1: START POSITION OF SELECTED SEQUENCE IS SEPARATELY PROGRAMMABLE FOR EACH OUTPUT
 2: HD LINE LENGTH
 3: SEQUENCE POINTERS (SPTR) TO SELECT AN INDIVIDUAL SEQUENCE FOR EACH OUTPUT
 4: ANY SEQUENCES MAY ALSO BE ALTERNATED FOR ADDITIONAL FLEXIBILITY

Figure 21. Individual Vertical Region Programmability

Table VIII. Individual Vertical Region Parameters

Register	Length	Range	Description
HDLEN	12b	0–4095 Pixels	HD Line Length for Lines in Each Region 0–4
VxSTART	12b	0–4095 Pixel Location	Sequence Start Position for Each Vx Output in Each Region 0–4
VxSPTRFIRST	4b	Sequence 0–11	Sequence Pointer for Vx Output during Each Region 0–4 (Can Be Used with SPTRSECOND for Alternation, See Text)
VxINVFIRST	1b	High/Low	When High, the Polarity of Sequence VxSPTRFIRST Is Inverted

x is the V-output from 1–4.

Complete Field: Combining the Regions

The individual regions are combined into a complete field readout by using region change positions (RCP) and region pointers (REGPTR). Figure 22 shows how each field is divided into multiple regions. This allows the user to change the vertical timing during various stages of the image readout. The boundaries of each region are defined by the sequence change positions (RCP). Each RCP is a 12-bit value representing the line number bounding the region. A total of seven RCPs allow up to eight

different region areas in the field to be defined. The first RCP is always hard-coded to zero, and the remaining seven are register programmable. Note that there are only five possible individual regions that can be defined, but the eight region areas allow the same region to be used in more than one place during the field. Within each region area, the region pointers specify which of the five individual regions will be used. There are eight region pointers, one for each region area. Table IX summarizes the registers for the region change positions and region pointers.

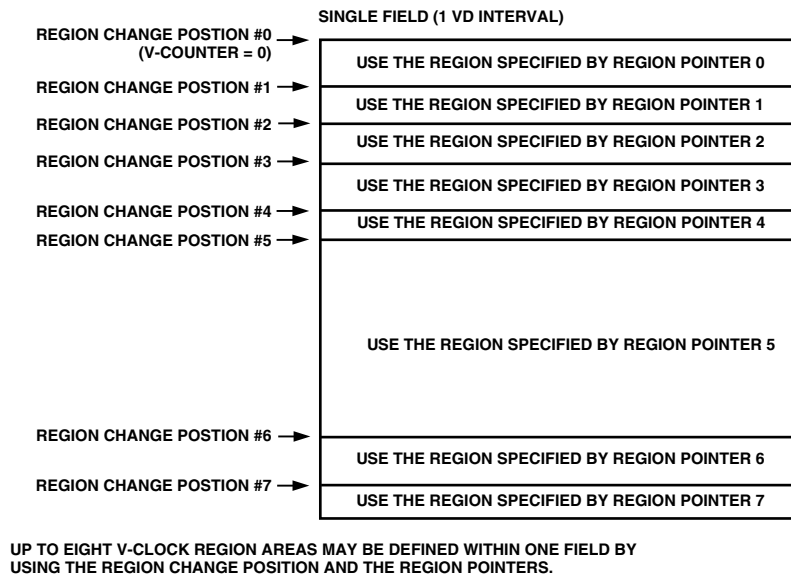

Figure 22. Complete Field Using Multiple Region Areas

Table IX. Complete Vertical Field Registers

Register	Length	Range	Description
VTPRCP	12b	0–4095 Line Location	Region Change Position for each Region Area in Field
VTPREGPTR	3b	Region 0–4	Region Pointer for each Region Area of Field

Vertical Sequence Alternation

The AD9891/AD9895 also supports line-by-line alternation of vertical sequences within any region, as shown in Figure 23. Table X summarizes the additional registers used to support different alternation patterns. To create an alternating vertical pattern,

the VxSPTRFIRST and VxSPTRSECOND Registers are programmed with the desired sequences to be alternated. The VTPALT Register must be set HIGH for that region to use alternation. If VTPALT is LOW, then the VxSPTRSECOND Registers will be ignored. Figure 24 shows an example of line-by-line alternation.

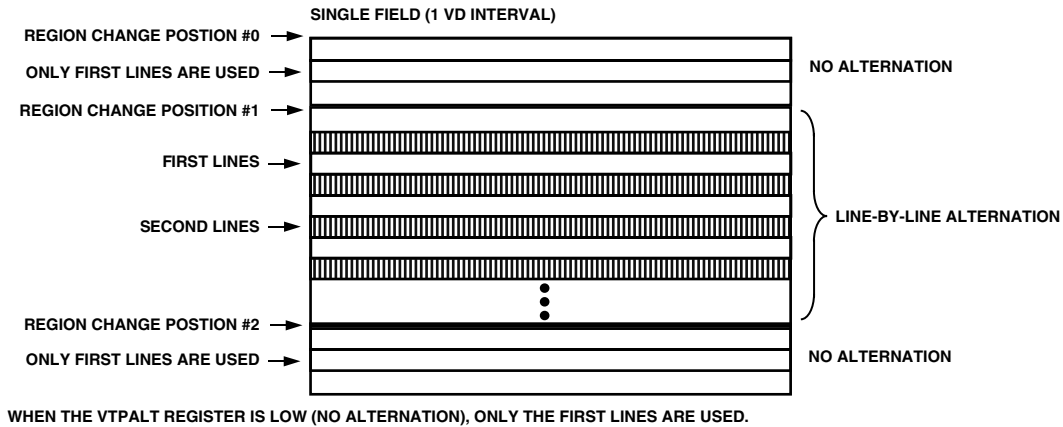
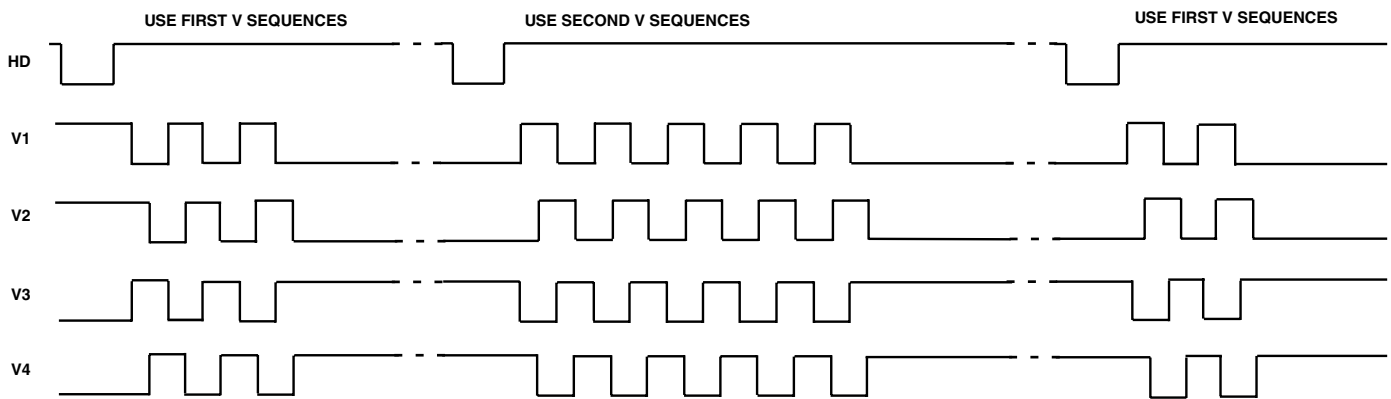

Figure 23. Use of Line Alteration in Vertical Sequencing



SEQUENCES MAY BE ALTERNATED WITHIN A REGION BY USING THE SPTRFIRST AND SPTRSECOND REGISTERS.

Figure 24. Example of Line Alteration within a Region

Table X. Vertical Sequence Alternation Parameters

Register	Length	Range	Description
VTPALT	1b	Enabled/Disabled	Enables the Line-by-Line Alternation (1 = Enabled)
VxSPTRFIRST	4b	Sequence 0–11	SPTR for Vx Output during Each Region 0–4 for FIRST Lines
VxINVFIRST	1b	High/Low	When High, the Polarity of VxSPTRFIRST Is Inverted
VxSPTRSECOND	4b	Sequence 0–11	SPTR for Vx Output during Each Region 0–4 for SECOND Lines
VxINVSECOND	1b	High/Low	When High, the Polarity of VxSPTRSECOND Is Inverted

x is the V-output from 1–4.

AD9891/AD9895

Second Vertical Sequence During VSG Lines

Most CCDs require additional vertical timing during the sensor gate line. The AD9891/AD9895 supports the option to output a second set of sequences for V1–V4 during the line when the sensor gates VSG1–VSG4 are active. Figure 25 shows a typical VSG line, which includes two separate sets of vertical sequences on V1–V4. The sequences at the start of the line are the same as those generated in the previous line. But the second sequence only occurs in the line where the VSG signals are active. To select the sequences used for the second sequence, the registers in Table XI are used. To enable the second set of sequences during the VSG line, the VTP_SGLINEMODE is set HIGH. As with the standard vertical regions, each V1–V4 output has an individual start position, programmed in the VxSTART_SGLINE Registers. Each V1–V4 output can select from the pool of 12 unique sequences using individual sequence pointer registers, VxSPTR_SGLINE. Also, any sequence may be inverted for a particular V1–V4 output by using the VxINV_SGLINE Registers.

Vertical Sweep Mode Operation

The AD9891/AD9895 contains a special mode of vertical timing operation called Sweep Mode. This mode is used to generate a large number of repetitive pulses that span across multiple HD lines. One example of where this mode may be needed is at the start of the CCD readout operation. At the end of the image exposure, but before the image is transferred by the sensor gate

pulses, the vertical interline CCD Registers should be “clean” of all charge. This can be accomplished by quickly shifting out any charge with a long series of pulses on the V1–V4 outputs. Depending on the vertical resolution of the CCD, up to two or three thousand clock cycles will be needed to shift the charge out of each vertical CCD line. This operation will span across multiple HD line lengths. Normally, the AD9891/AD9895 sequences are contained within one HD line length. But when Sweep Mode is enabled, the HD boundaries will be ignored until the region is finished. To enable Sweep Mode within any region, program the appropriate SWEEP (0–4) Registers to HIGH.

Figure 26 shows an example of the Sweep Mode operation. The number of vertical pulses needed will depend on the vertical resolution of the CCD. The V1–V4 output signals are generated using the Individual Vertical Sequence Registers (shown in Table VII). A single pulse is created using the first, second, and third toggle positions, and then the number of repeats is set to the number of vertical shifts required by the CCD. The maximum number of repeats is 4096 in this mode, using the VTPREP Register. This produces a pulse train of the appropriate length. Normally, the pulse train would be truncated at the end of the HD line length. But with Sweep Mode enabled for this region, the HD boundaries will be ignored. In Figure 26, the sweep region occupies 23 HD lines. After the Sweep Mode region is completed, normal sequence operation will resume in the next region.

Table XI. Second Vertical Sequence Registers During SG Lines

Register Name	Length	Range	Description
VTP_SGLINEMODE	1b	HIGH/LOW	To Turn on Second Sequences during SG Line, Set = HIGH
VxSTART_SGLINE	12b	0–4095 Pixel Location	Sequence Start Position for Each Vx Output for SG Line Sequence
VxSPTR_SGLINE	4b	0–11 Sequence #	Sequence Pointer for Vx Output during second SG Line Sequence
VxINV_SGLINE	1b	HIGH/LOW	When HIGH, the Polarity of Sequence VxSPTRFIRST Is Inverted

x is the V-output from 1–4.

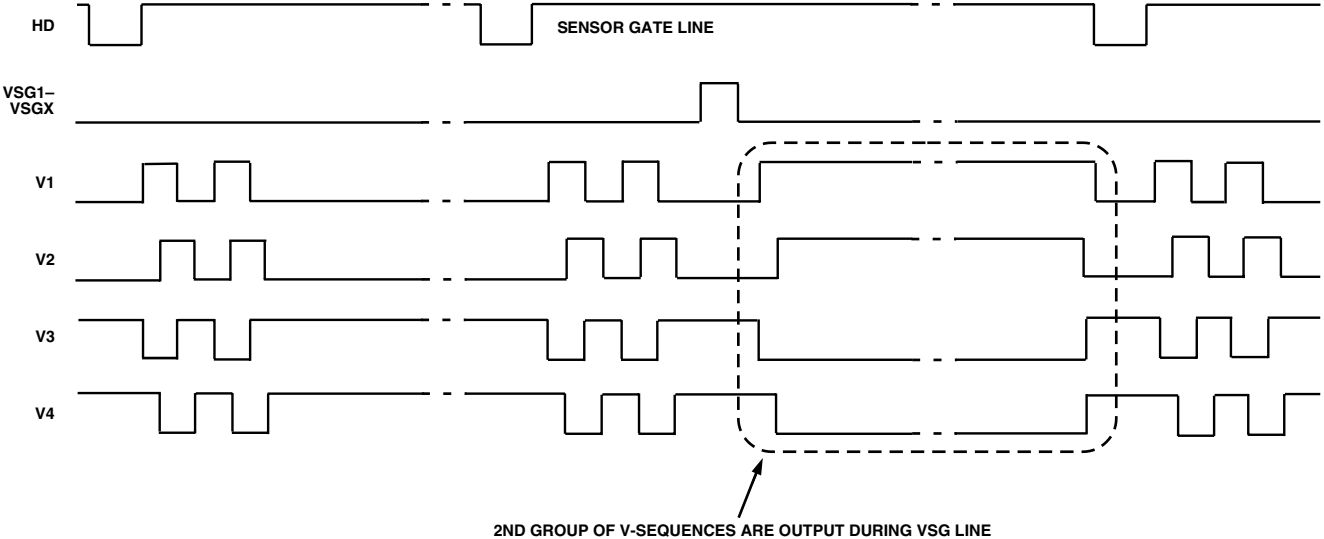

Figure 25. Example of Second Sequences During Sensor Gate Line

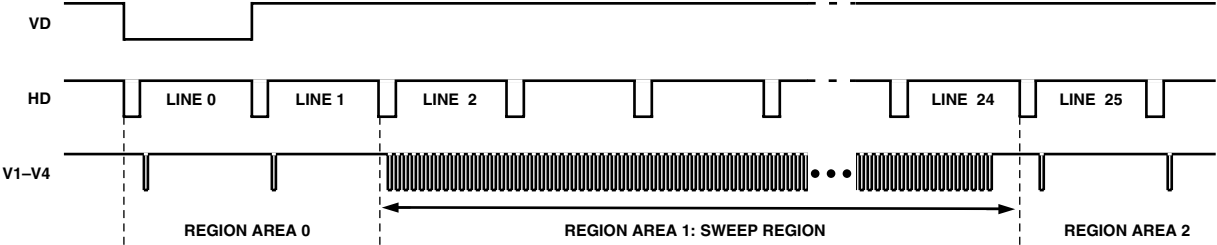

Figure 26. Example of Sweep Region for High Speed Vertical Shift

AD9891/AD9895

Vertical Multiplier Mode

To generate very wide vertical timing pulses, a vertical region may be configured into Multiplier Mode. This mode uses the vertical sequence registers in a slightly different manner. Multiplier Mode can be used to support unusual CCD timing requirements, such as vertical pulses that are wider than a single HD line length.

The start polarity and toggle positions are still used in the same manner as the standard sequence generation, but the length is used differently. Instead of using the pixel counter (HD counter) to specify the toggle position locations (VTPTOG1, 2, 3) of the sequence, VTP length (VTPLEN) is multiplied by the VTPTOG position to allow very long sequences to be generated. To calculate the exact toggle position, counted in pixels after the start position:

$$\text{Multiplier Toggle Position} = \text{VTPTOG} \times \text{VTPLEN}$$

Because the VTPTOG Register is multiplied by VTPLEN, the resolution of the toggle position placement is reduced. If VTPLEN = 4, the toggle position accuracy is now reduced to 4-pixel steps instead of single pixel steps. Table XII summarizes how the Individual Vertical Sequence Registers are programmed for Multiplier Mode operation. Note that the bit ranges for the VTPTOG and VTPREP Registers differ from the normal operation shown in Table VII. In Multiplier Mode, the VTPREP Register should always be programmed to the same value as the highest toggle position register.

The example shown in Figure 27 illustrates this operation. The first toggle position is 2 and the second toggle position is 9. In Nonmultiplier Mode, this would cause the V-sequence to toggle at pixel 2 and then pixel 9 within a single HD line. However, now toggle positions are multiplied by the VTPLEN = 4, so the first toggle occurs at pixel count = 8, and the second toggle occurs at pixel count = 36. Sweep Mode should be enabled to allow the toggle positions to cross the HD line boundaries.

Frame Transfer CCD Mode

The AD9891/AD9895 may also be configured for use with frame transfer CCDs. In Frame Transfer CCD (FTCCD) Mode, an additional four vertical outputs are available for a total of eight outputs (V1–V8). In this case, V1–V4 are used for clocking the active image area, and V5–V8 are used for clocking the storage area. In FTCCD Mode, the sequences assigned to the V1–V4 outputs are duplicated at the V5–V8 outputs to allow the storage area to be clocked along with the image area. Individual masking of the V1–V4 and V5–V8 outputs allows for vertical decimation techniques during transfer from the image to the storage area. The additional outputs V5–V8 are available on four of the sensor gate output pins, VSG1–VSG4. Figure 28 shows an example of the eight V-clocks configured for use with a frame transfer CCD.

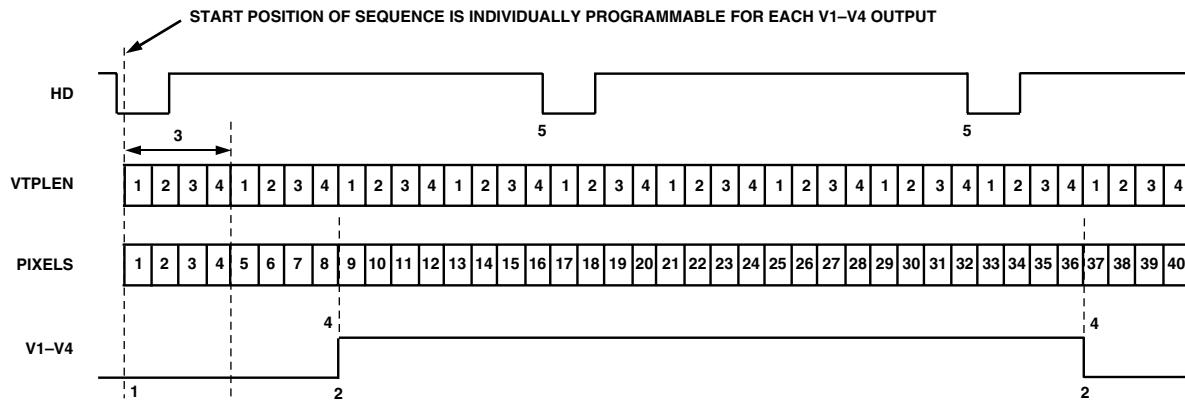

- MULTIPLIER MODE VERTICAL SEQUENCE PROPERTIES:**
- 1: START POLARITY (ABOVE: STARTPOL = 0)
 - 2: 1ST, 2ND, AND 3RD TOGGLE POSITIONS (ABOVE: VTPTOG1 = 2, VTPTOG2 = 9)
 - 3: LENGTH OF VTP COUNTER (ABOVE: VTPLEN = 4). THIS IS THE MINIMUM RESOLUTION FOR TOGGLE POSITION CHANGES.
 - 4: TOGGLE POSITIONS OCCUR AT LOCATION EQUAL TO (VTPTOG × VTPLEN)
 - 5: ENABLE SWEEP REGION ALLOWS THE COUNTERS TO CROSS THE HD BOUNDARIES

Figure 27. Example of Multiplier Region for Wide Vertical Pulse Timing

Table XII. Multiplier Mode and Sequence Register Parameters

Register	Length	Range	Description
MULTI	1b	HIGH/LOW	High Enables Multiplier Mode for Each Region 0–4
VTPPOL	1b	HIGH/LOW	Starting Polarity of Vertical Transfer Pulse for Each Sequence 0–11
VTPTOG1	12b	0–4095 Pixel Location	First Toggle Position for Each Sequence 0–11
VTPTOG2	12b	0–4095 Pixel Location	Second Toggle Position for Each Sequence 0–11
VTPTOG3	12b	0–4095 Pixel Location	Third Toggle Position for Each Sequence 0–7
VTPLEN	10b	0–1023 Pixels	“Multiplier” Factor for Repetition Counter
VTPREP	12b	0–4096	Should Be Programmed to the Same Value as the Highest Toggle Position

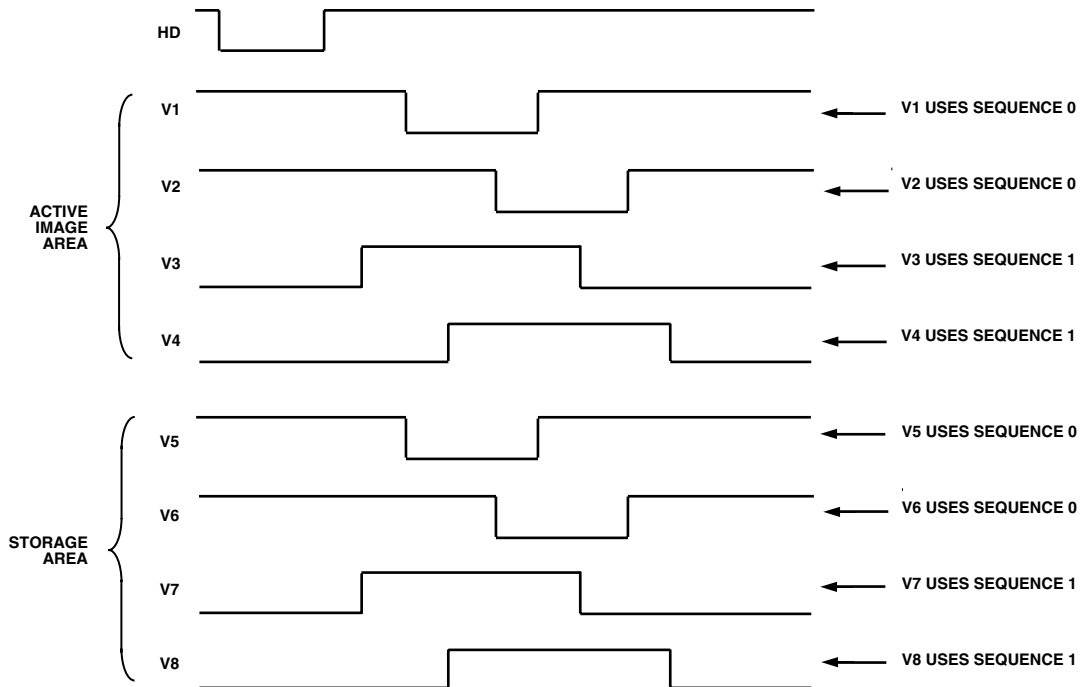

Figure 28. Example of Frame Transfer CCD Mode using V1-V8

The frame transfer CCD also requires additional timing control when decimating the image for Preview Mode. The AD9891/AD9895 contain registers to independently stop the operation of the V5-V8 outputs while the V1-V4 outputs continue to run or to stop the V1-V4 outputs, while the V5-V8 outputs remain operational. The FREEZE and RESUME Registers specify the pixel locations within each line of a region where the V1-V4 or V5-V8 clock outputs will start to hold their state, and where they will resume normal operation. FREEZE and RESUME can be used in any region during the frame readout.

Vertical Sensor Gate (Shift Gate) Timing

With an interline CCD, the vertical sensor gates (VSG) are used to transfer the pixel charges from the light-sensitive image area into the light-shielded vertical registers. When a mechanical shutter is not being used, this transfer will effectively end the exposure period during the image acquisition. From the light-shield vertical registers, the image is then read out line-by-line by using the vertical transfer pulses V1-V4 in conjunction with the high speed horizontal clocks.

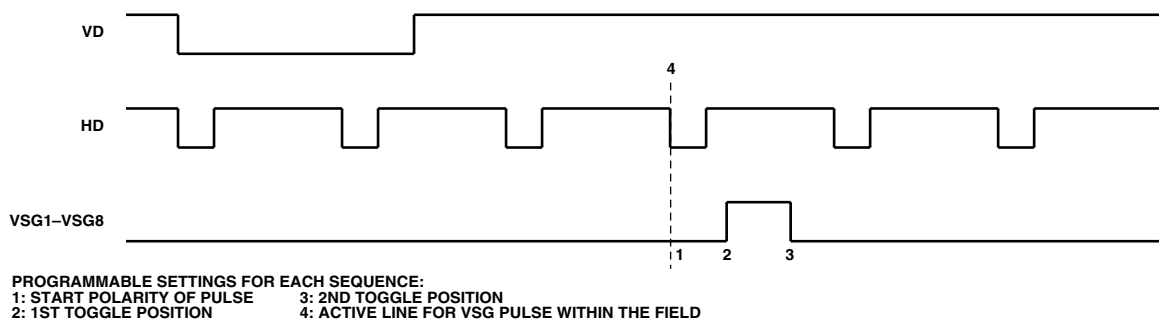

Figure 29. Vertical Sensor Gate Pulse Placement

Table XIII. Sensor Gate Register Parameters

Register	Length	Range	Description
SGPOL	1b	High/Low	Sensor Gate Starting Polarity for Sequence 0-3
SGTOG1	12b	0-4095 Pixel Location	First Toggle Position for Sequence 0-11
SGTOG2	12b	0-4095 Pixel Location	Second Toggle Position for Sequence 0-11
SGACTLINE	12b	0-4095 Pixel Location	Line in Field where VSG1-VSG8 Are Active
SGSEL	2b	Sequence 0-3	Selects Sequence 0-3 for VSG1-VSG8
SGMASK	8b	8 Individual Bits	Masking for any of VSG1-VSG8 Signals (0 = On, 1 = Mask)

AD9891/AD9895

Table XIII contains the summary of the VSG Registers. The AD9891/AD9895 has eight SG outputs, VSG1–VSG8. Each of the outputs can be assigned to one of four programmed sequences by using the SGSEL1–SGSEL8 Registers. Each sequence is generated in the same manner as the individual vertical sequences, with a programmable start polarity (SGPOL), first toggle position (SGTOG1), and second toggle position (SGTOG2). The active line where the VSG1–VSG8 pulses occur is programmable using the two SGACTION Registers. Additionally, any of the VSG1–VSG8 pulses may be individually disabled by using the SGMASK Register. The masking allows all of the different SG sequences to be preprogrammed and the appropriate pulses for odd or even fields can be masked.

SHUTTER TIMING CONTROL

CCD image exposure time is controlled through use of the substrate clock signal (SUBCK), which pulses the CCD substrate to clear out accumulated charge. The AD9891/AD9895 supports three types of electronic shuttering: Normal Shutter Mode, High Precision Shutter Mode, and Low Speed Shutter Mode. Along with the SUBCK pulse placement, the AD9891/AD9895 can accommodate different progressive and interlaced readout modes. Additionally, the AD9891/AD9895 provides output signals to control an external mechanical shutter, strobe (flash), and the CCD bias for still mode readout (VSUB).

Normal Shutter Mode

Figure 30 shows the VD and SUBCK output for Normal Shutter Mode. The SUBCK will pulse once per line, and the total number of repetitions within the field is programmable. The pulse polarity, width, and line location is programmable using the SUBCKPOL, SUBCK1TOG1, and SUBCK1TOG2 Registers

(see Table XIV). The number of SUBCK pulses per field is programmed in the SUBCKNUM Register.

As shown in Figure 30, the SUBCK pulses will always begin on the line after the sensor gates occur, specified by the SGACTLINE Register (Addr x265 and Addr x266). The SUBCKPOL, SUBCK1TOG, SUBCK2TOG, and SUBCKNUM Registers are updated at the start of the line after the sensor gate line. All other shutter mode registers are updated with the majority of the AD9891/AD9895's registers at the VD/HD falling edge.

High Precision Shutter Mode

High precision shuttering is controlled in the same way as normal shuttering but requires a second set of toggle registers. In this mode, the SUBCK still pulses once per line, but the last SUBCK in the field will have an additional SUBCK pulse whose location is determined by the SUBCK2TOG1 and SUBCK2TOG2 Registers (see Figure 31). Finer resolution of the exposure time is possible using this mode. Leaving both SUBCK2TOG Registers set to 4095 (x3F) will disable the High Precision Mode (default setting).

Low Speed Shutter Mode

For normal exposure times less than one field interval, the EXPOSURE Register will be set to 0. Exposure times greater than one field interval can be achieved by writing a value greater than zero to the EXPOSURE Register. As shown in Figure 32, this shutter mode will suppress the SUBCK and VSG outputs for up to 4095 fields (VD periods). The VD and HD outputs may be suppressed during the exposure period by programming the VDHDOFF Register to 1.

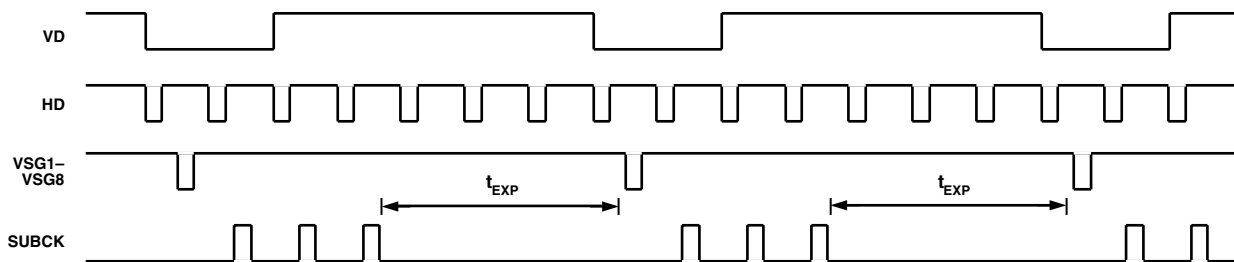

SUBCK PROGRAMMABLE SETTINGS:
 1: PULSE POLARITY USING THE SUBCKPOL REGISTER
 2: NUMBER OF PULSES WITHIN THE FIELD USING THE SUBCKNUM REGISTER
 3: PIXEL LOCATION OF PULSE WITHIN THE LINE AND PULSE WIDTH PROGRAMMED USING SUBCK1 TOGGLE POSITION REGISTERS

Figure 30. Normal Shutter Mode

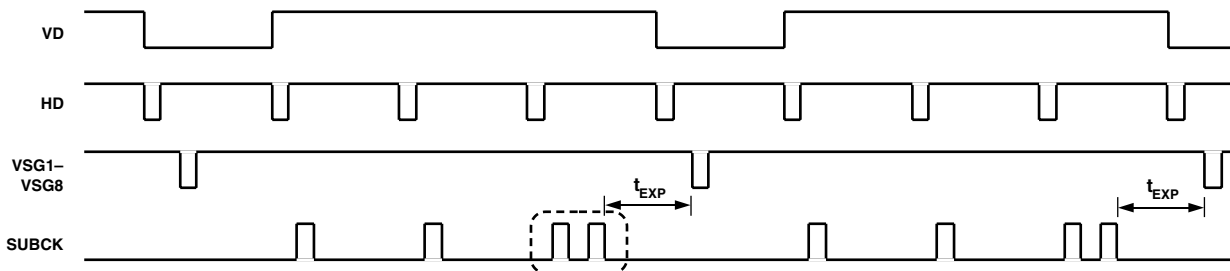

NOTES
 1. 2ND SUBCK PULSE IS ADDED IN THE LAST SUBCK LINE.
 2. LOCATION OF 2ND PULSE IS FULLY PROGRAMMABLE USING THE SUBCK2 TOGGLE POSITION REGISTERS.

Figure 31. High Precision Shutter Mode

SUBCK Suppression

Normally, the SUBCKs will begin to pulse on the line following the sensor gate line (VSG). With some CCDs, the SUBCKs need to be suppressed for one or more lines following the VSG line. The SUBCKSUPPRESS Register allows for the suppression the SUBCK pulses for up to 63 lines following the VSG line.

Readout After Exposure

A write to the EXPOSURE Register will designate the number fields in the exposure time (t_{EXP}) from 0 to 4095. After the exposure, the readout of the CCD data occurs. During readout, the SUBCK output may need to be further suppressed until the readout is completed. The READOUT Register specifies the number of additional fields after the exposure to continue the suppression of SUBCK. READOUT can be programmed for zero to seven additional fields and should be preprogrammed at start-up, not at the same time as the exposure write. A typical interlaced CCD frame readout mode will generally require two additional fields of SUBCK suppression (READOUT = 2).

Note that a write to the EXPOSURE Register acts as a trigger for readout after the exposure is completed. If no write to the EXPOSURE Register occurs, than the READOUT Register will have no effect. See Figure 35 for an example of triggering the exposure and subsequent readout.

VSUB Control

The CCD readout bias (VSUB) can be programmed to accommodate different CCDs. Figure 35 shows two different modes that are available. In Mode 0, VSUB goes active during the field of the last SUBCK when the exposure begins. The on-position (rising edge in Figure 35) is programmable to any line within the field. VSUB will remain active until the end of the image readout. In Mode 1, the VSUB is not activated until the start of the readout.

MSHUT and STROBE Control

MSHUT and STROBE operation is shown in Figures 33, 34, and 35. Table XV shows the registers parameters for controlling the MSHUT and STROBE outputs. The MSHUT output is switched on with the MSHUTON Registers, and it will remain on until the location specified in the MSHUTOFF Registers. The location of MSHUTOFF is fully programmable to anywhere within the exposure period, using the FD (field), LN (line), and PX (pixel) Registers. The STROBE pulse is defined by the ON and OFF positions. STROBON_FD is the field in which the STROBE is turned on, measured from the field containing the last SUBCK before exposure begins. The STROBON_LN and STROBON_PX Registers give the line and pixel positions with respect to STROBON_FD. The STROBE off position is programmable to any field, line, and pixel location with respect to the field of the last SUBCK.

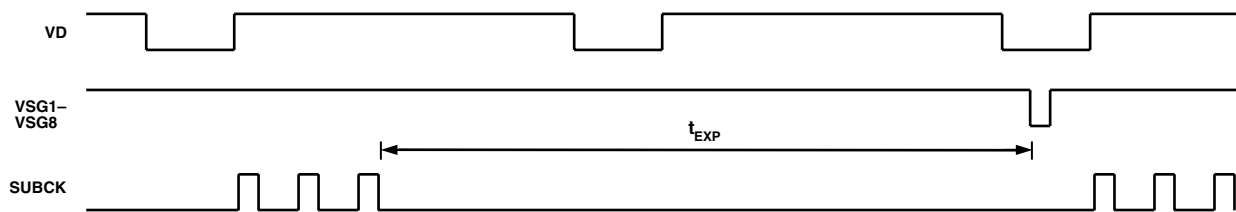

NOTES

1. SUBCK MAY BE SUPPRESSED FOR MULTIPLE FIELDS BY PROGRAMMING THE EXPOSURE REGISTER GREATER THAN ZERO.
2. ABOVE EXAMPLE USES EXPOSURE = 1.
3. VD/HD OUTPUTS MAY ALSO BE SUPPRESSED USING THE VDHD OFF REGISTER = 1.

Figure 32. Low Speed Shutter Mode Using EXPOSURE Register

Table XIV. Electronic Shutter Mode Register Parameters

Register	Length	Range	Description
SUBCKPOL*	1b	HIGH/LOW	SUBCK Start Polarity for SUBCK1 and SUBCK2
SUBCK1TOG1*	12b	0–4095 Pixel Location	SUBCK First Toggle Position
SUBCK1TOG2*	12b	0–4095 Pixel Location	SUBCK Second Toggle Position
SUBCK2TOG1*	12b	0–4095 Pixel Location	Second SUBCK First Toggle Position (for High Precision Mode)
SUBCK2TOG2*	12b	0–4095 Pixel Location	Second SUBCK Second Toggle Position (for High Precision Mode)
SUBCKNUM*	12b	0–4095 # of Pulses	Total Number of SUBCKs per Field (at 1 Pulse per Line)
SUBCKSUPPRESS*	6b	0–63 # of Pulses	Number of SUBCK's to Suppress after VSG Line
EXPOSURE	12b	0–4095 # of Fields	Number of Fields to Suppress to SUBCK and VSG; Triggers Readout to Occur after t_{EXP}
VDHD OFF	1b	ON/OFF	Disable VD/HD Output during Exposure (1 = On, 0 = Off)
READOUT	3b	0–7 # of Fields	Number of Fields to Suppress SUBCK after Exposure (for Readout)

*Register is not VD/HD updated but is updated at the start of line after sensor gate line.

AD9891/AD9895

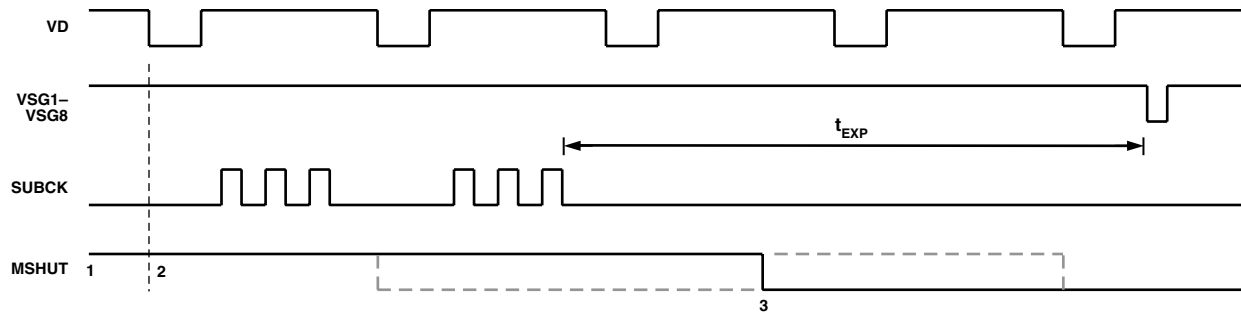

MSHUT PROGRAMMABLE SETTINGS:
 1: ACTIVE POLARITY
 2: ON-POSITION IS VD UPDATED AND MAY BE SWITCHED ON AT ANY TIME
 3: OFF-POSITION CAN BE PROGRAMMED ANYWHERE FROM THE FIELD OF LAST SUBCK UNTIL THE FIELD BEFORE READOUT

Figure 33. MSHUT Output Programmability

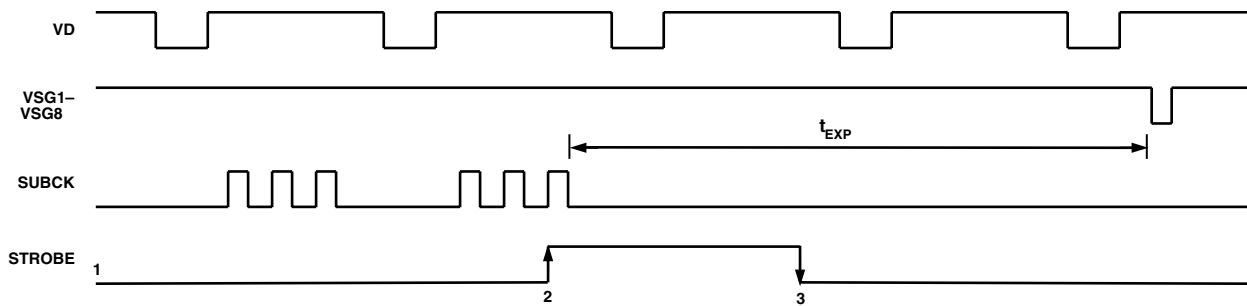

STROBE PROGRAMMABLE SETTINGS:
 1: ACTIVE POLARITY
 2: ON-POSITION WITH RESPECT TO TO FIELD OF LAST SUBCK
 3: OFF-POSITION CAN BE PROGRAMMED ANYWHERE DURING THE EXPOSURE TIME

Figure 34. STROBE Output Programmability

Table XV. VSUB, MSHUT, and STROBE Register Parameters

Register	Length	Range	Description
TRIGGER	3b	On/Off for Three Signals	1-Bit Triggers for VSUB[0], MSHUT[1], and STROBE[2]
VSUBMODE	1b	HIGH/LOW	VSUB Mode (0 = Mode 0, 1 = Mode 1) (See Figure 27)
VSUBKEEPON	1b	HIGH/LOW	Sets VSUB to Stay Active after Readout When High
VSUBPOL	1b	HIGH/LOW	VSUB Active Polarity
VSUBON	12b	0–4095 Line Location	VSUB On Position. Active starting in any line of field.
MSHUTON	1b	ON/OFF	MSHUT Signal Enable (1 = Active or “Open”)
MSHUTONPOS_LN	12b	0–4095 Line Location	MSHUT Line Location
MSHUTONPOS_PX	12b	0–4095 Pixel Location	MSHUTON Pixel Location
MSHUTPOL	1b	HIGH/LOW	MSHUT Active Polarity
MSHUTOFF_FD	12b	0–4095 Field Location	Field Location to Switch OFF MSHUT. (Inactive or “Closed”)
MSHUTOFF_LN	12b	0–4095 Line Location	Line Location to Switch OFF MSHUT. (Inactive or “Closed”)
MSHUTOFF_PX	12b	0–4095 Pixel Location	Pixel Location to Switch OFF MSHUT. (Inactive or “Closed”)
STROBPOL	1b	HIGH/LOW	STROBE Active Polarity
STROBON_FD	12b	0–4095 Field Location	STROBE ON Field Location, with Respect to Last SUBCK Field
STROBON_LN	12b	0–4095 Line Location	STROBE ON Line Location
STROBON_PX	12b	0–4095 Pixel Location	STROBE ON Pixel Location
STROBOFF_FD	12b	0–4095 Field Location	STROBE OFF Field Location, with Respect to Last SUBCK Field
STROBOFF_LN	12b	0–4095 Line Location	STROBE OFF Location
STROBOFF_PX	12b	0–4095 Pixel Location	STROBE OFF Location

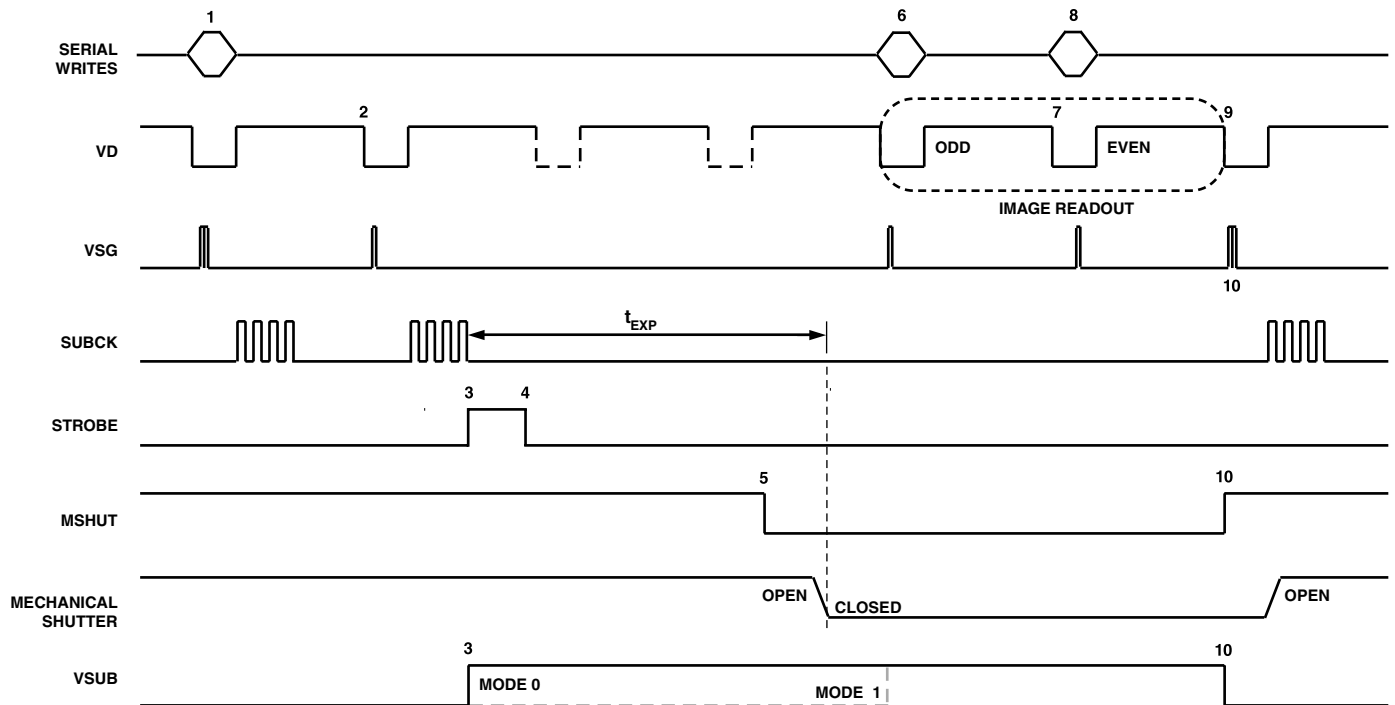

Figure 35. Exposure and Readout of Interlaced Frame

Example of Exposure and Readout of Interlaced Frame

Figure 35 shows the sequence of events for a typical exposure and readout operation using a mechanical shutter and strobe. The register values for the VSUB, MSHUT, and STROBE toggle positions may be previously loaded at any time, prior to triggering these functions. Additional register writes are required to configure the vertical clock outputs, V1–V4, which are not described here.

- 0: Write to the READOUT Register (Addr x281) to specify the number of fields to further suppress SUBCK while the CCD data is readout. In this example, READOUT = 2.
- 1: Write to the EXPOSURE Register (Addr x27D) to start the exposure and specify the number of fields to suppress SUBCK and VSG outputs during exposure. In this example, EXPOSURE = 2.

Write to the TRIGGER Register (Addr x280) to enable the STROBE, MSHUT, and VSUB signals. To trigger all three signals (as in Figure 36) the register TRIGGER = 7.

Write to the SGACTION Register (Addr x265 and Addr x266) and SGMASK Register (Addr x26F and Addr x270) to configure the sensor gates for ODD field readout (interlaced CCD).

- 2: VD/HD falling edge will update the serial writes from 1.
- 3: If VSUB Mode = 0, VSUB output turns ON at the line specified in the VSUBON Register (Addr x272 and Addr x273).

STROBE output turns ON at the location specified in the STROBON Registers (Addr x294 to Addr x299).

- 4: STROBE output turns OFF at the location specified in the STROBOFF Registers (Addr x29A to Addr x29F).
- 5: MSHUT Output turns OFF at the location specified in the MSHUTOFF Registers (Addr x28D to Addr x292).
- 6: Write to the SGACTION Register (Addr x253 and Addr x254) and SGMASK Register to configure the sensor gates for EVEN field readout.
- 7: VD/HD falling edge will update the serial writes from 6.
- 8: Write to the SGACTION Register and SGMASK Register to reconfigure the sensor gates for Draft/Preview Mode output. Write to the MSHUTON Register (Addr x287) to reopen the mechanical shutter for Draft/Preview Mode.
- 9: VD/HD falling edge will update the serial writes from 8.
- 10: VSG outputs returns to Draft/Preview Mode timing. SUBCK output resumes operation. MSHUT output returns to the ON position (Active or “Open”). VSUB output returns to the OFF position (Inactive).

AD9891/AD9895

ANALOG FRONT END DESCRIPTION AND OPERATION

The AD9891/AD9895 AFE signal processing chain is shown in Figure 36. Each processing step is essential in achieving a high quality image from the raw CCD pixel data. AFE Register details are shown in Table XXXI.

DC Restore

To reduce the large dc offset of the CCD output signal, a dc-restore circuit is used with an external $0.1 \mu\text{F}$ series coupling capacitor. This restores the dc level of the CCD signal to approximately 1.5 V, to be compatible with the 3 V analog supply of the AD9891/AD9895.

Correlated Double Sampler

The CDS circuit samples each CCD pixel twice to extract the video information and reject low frequency noise. The timing shown in Figure 10 illustrates how the two internally generated CDS clocks, SHP and SHD, are used to sample the reference level and the data level, respectively, of the CCD signal. The placement of the SHP and SHD sampling edges is determined by the setting of the SHPPOSLOC and SHDPOSLOC Registers located at Addr 0xE9 and Addr 0xEA, respectively. Placement of these two clock signals is critical in achieving the best performance from the CCD.

Input Clamp

A line-rate input clamping circuit is used to remove the CCD's optical black offset. This offset exists in the CCD's shielded black reference pixels. The AD9891/AD9895 remove this offset in the input stage to minimize the effect of a gain change on the

system black level. Another advantage of removing this offset at the input stage is to maximize system headroom. Some area CCDs have large black level offset voltages, which, if not corrected at the input stage, can significantly reduce the available headroom in the internal circuitry when higher VGA gain settings are used.

The input clamp is controlled by the CLPDM signal, which is fully programmable (see Horizontal Clamping and Blanking section). System timing examples are shown in the Horizontal Timing Sequence Example section. It is recommended that the CLPDM pulse be used during valid CCD dark pixels. CLPDM may be used during the optical black pixels, either together with CLPOB or separately. The CLPDM pulse should be a minimum of 4 pixels wide.

PxGA

The PxGA provides separate gain adjustment for the individual color pixels. A programmable gain amplifier with four separate values, the PxGA has the capability to "multiplex" its gain value on a pixel-to-pixel basis (see Figure 37). This allows lower output color pixels to be gained up to match higher output color pixels. Also, the PxGA may be used to adjust the colors for white balance, reducing the amount of digital processing that is needed. The four different gain values are switched according to the "color steering" circuitry. Seven different color steering modes for different types of CCD color filter arrays are programmed in the AD9891/AD9895 AFE CTLMODE Register, at Addr 0x06 (see Figures 39a–39g for internal color steering timing). For

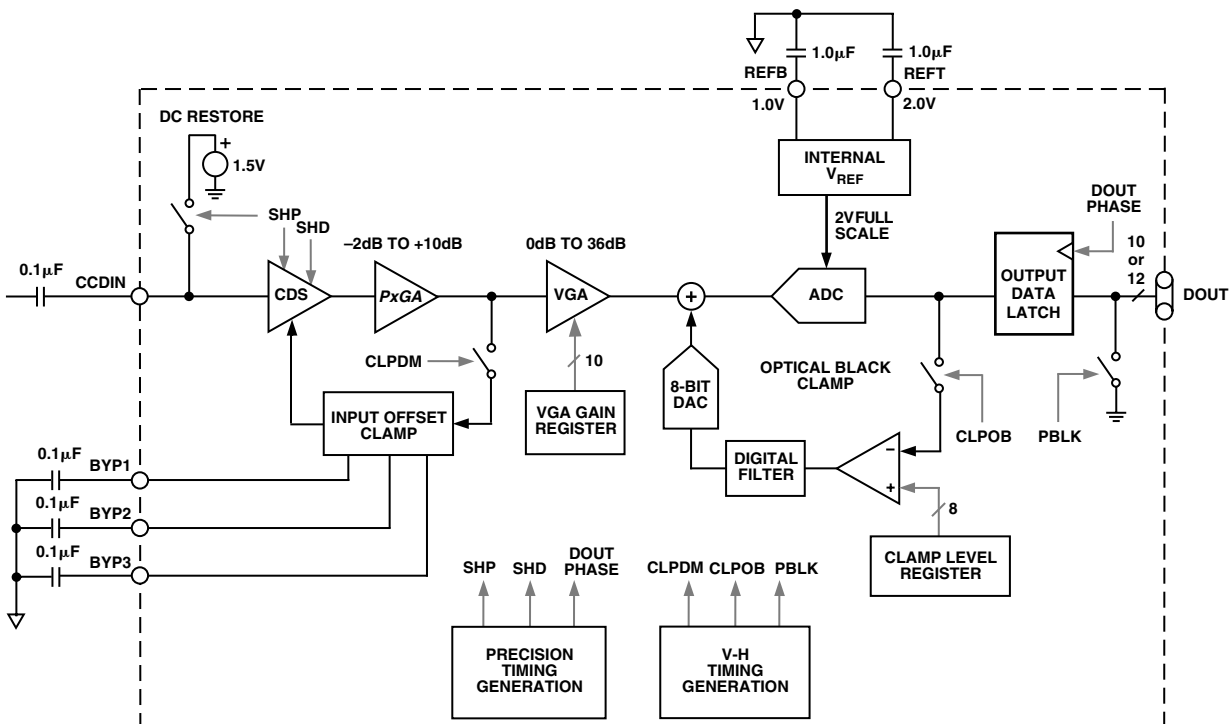
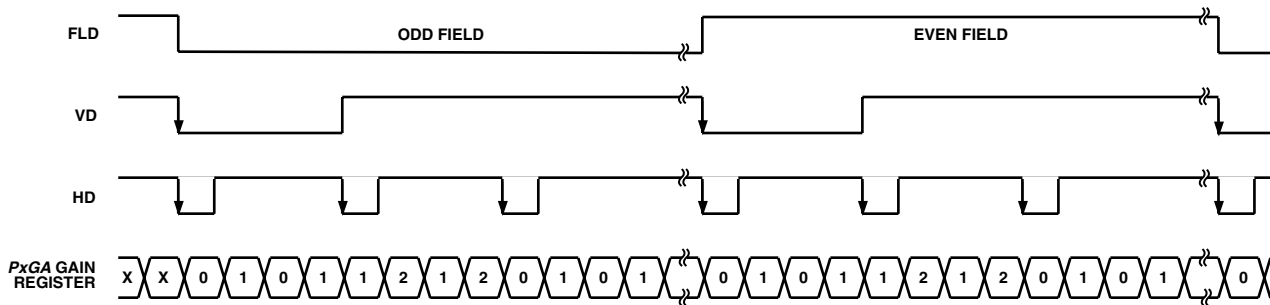

Figure 36. AFE Block Diagram

AD9891/AD9895



- NOTES
1. VD FALLING EDGE WILL RESET THE PxGA GAIN STEERING TO "0101" LINE.
 2. HD FALLING EDGES WILL ALTERNATE THE PxGA GAIN STEERING BETWEEN "0101" AND "1212" LINES.
 3. ALL FIELDS WILL HAVE THE SAME PxGA GAIN STEERING PATTERN (FLD STATUS IS IGNORED).

Figure 39c. Mosaic Repeat Color Steering Mode

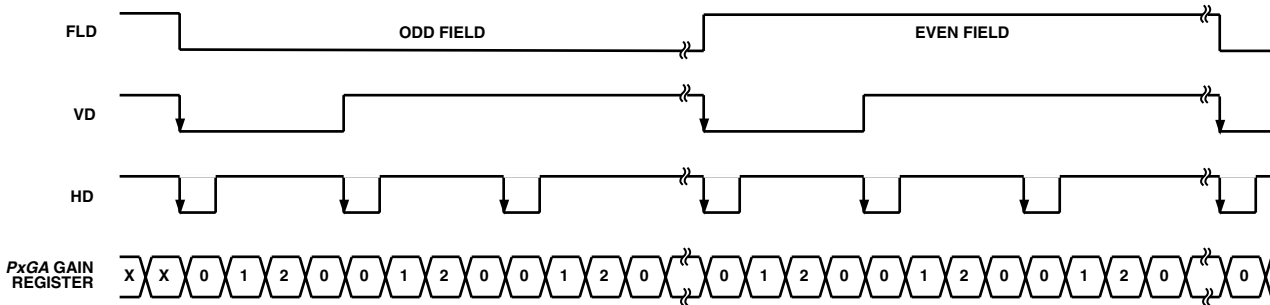

- NOTES
1. EACH LINE FOLLOWS "012012" STEERING PATTERN.
 2. VD AND HD FALLING EDGES WILL RESET THE PxGA GAIN REGISTER STEERING TO GAIN REGISTER "0."
 3. FLD STATUS IS IGNORED.

Figure 39d. 3-Color 1-Color Steering Mode

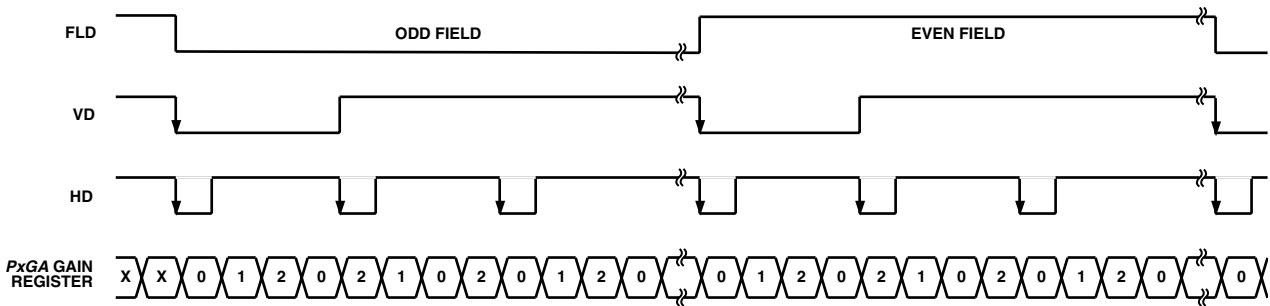

- NOTES
1. VD FALLING EDGE WILL RESET THE PxGA GAIN REGISTER STEERING TO "012012" LINE.
 2. HD FALLING EDGES WILL ALTERNATE THE PxGA GAIN REGISTER STEERING BETWEEN "012012" AND "210210" LINES.
 3. FLD STATUS IS IGNORED.

Figure 39e. 3-Color 2-Color Steering Mode

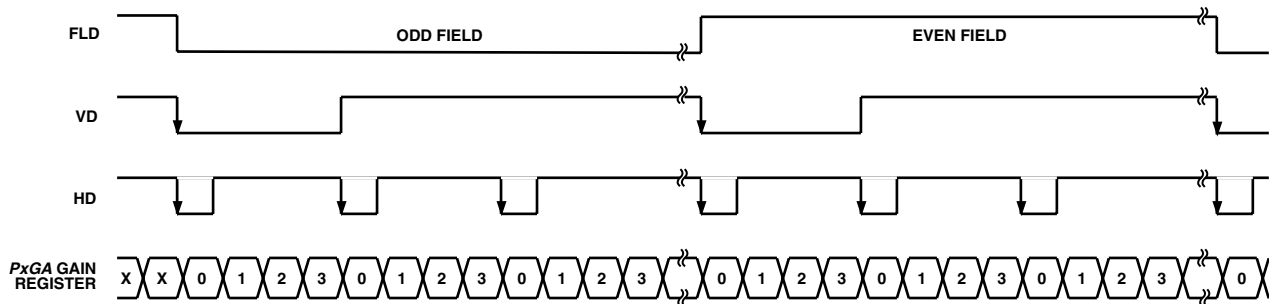

- NOTES
1. EACH LINE FOLLOWS "01230123" STEERING PATTERN.
 2. VD AND HD FALLING EDGES WILL RESET THE PxGA GAIN REGISTER STEERING TO GAIN REGISTER "0."
 3. FLD STATUS IS IGNORED.

Figure 39f. 4-Color 1-Color Steering Mode

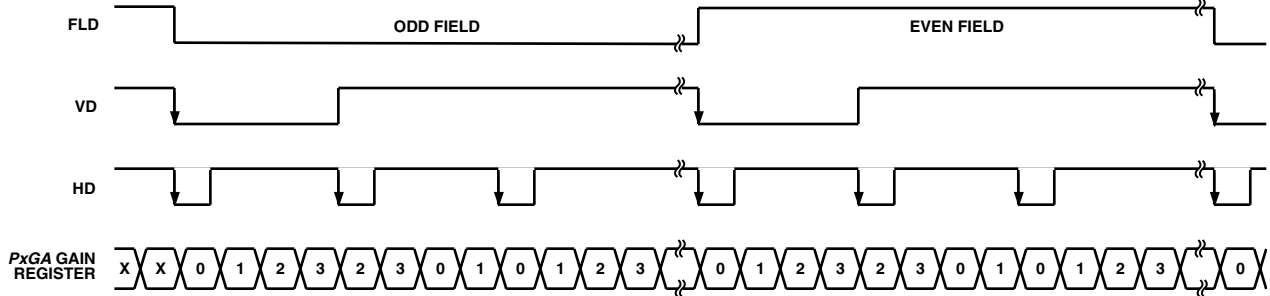

- NOTES**
1. VD FALLING EDGE WILL RESET THE *PxGA* GAIN REGISTER STEERING TO “01230123” LINE.
 2. HD FALLING EDGES WILL ALTERNATE THE *PxGA* GAIN REGISTER STEERING BETWEEN “01230123” AND “23012301” LINES.
 3. FLD STATUS IS IGNORED.

Figure 39g. 4-Color 2-Color Steering Mode

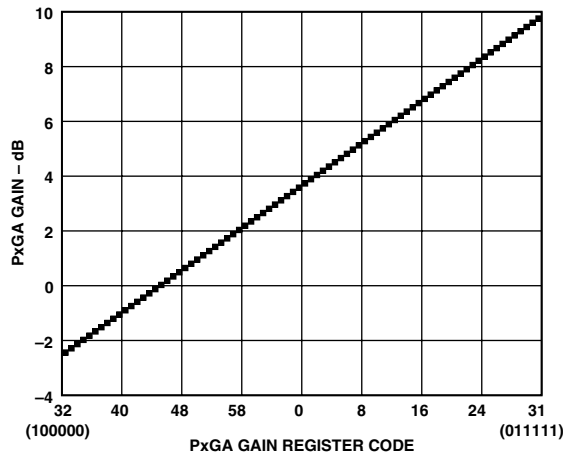

Figure 40. *PxGA* Gain Curve

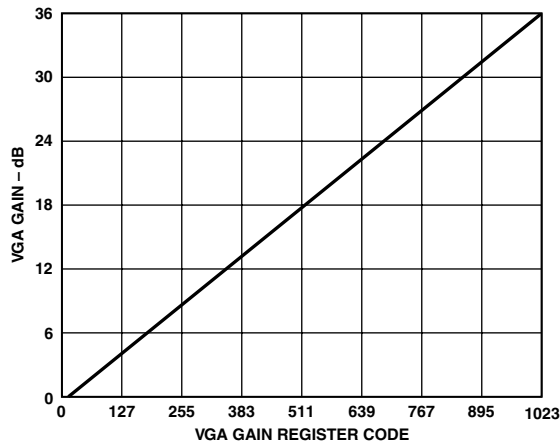

Figure 41. *VGA* Gain Curve (*PxGA* not included)

Variable Gain Amplifier

The *VGA* stage provides a gain range of 2 dB to 36 dB, programmable with 10-bit resolution through the serial digital interface. Combined with approximately 4 dB from the *PxGA* stage, the total gain range for the AD9891/AD9895 is 6 dB to 40 dB. The minimum gain of 6 dB is needed to match a 1 V input signal with the ADC full-scale range of 2 V. When compared to 1 V full-scale systems (such as ADI’s AD9803), the equivalent gain range is 0 dB to 34 dB.

The *VGA* gain curve follows a “linear-in-dB” characteristic. The exact *VGA* gain can be calculated for any gain register value by using the equation:

$$Gain = (0.035 \times Code) + 3.55$$

where the code range is 0 to 1023. *PxGA* default gain is included.

The gain accuracy specifications include the *PxGA* gain of approximately 4 dB, for a total gain range of 6 dB to 40 dB.

Optical Black Clamp

The optical black clamp loop is used to remove residual offsets in the signal chain and to track low frequency variations in the CCD’s black level. During the optical black (shielded) pixel interval on each line, the ADC output is compared with a fixed black level reference selected by the user in the Clamp Level Register. The clamp level is programmable in 256 steps, with a range between 0 LSB and 63.75 LSB in the AD9891 and between 0 LSB and 255 LSB in the AD9895. The resulting error signal is filtered to reduce noise, and the correction value is applied to the ADC input through a D/A converter. Normally, the optical black clamp loop is turned on once per horizontal line, but this loop can be updated more slowly to suit a particular application. If external digital clamping is used during the post-processing, the AD9891/AD9895 optical black clamping may be disabled using Bit D5 in the Operation Register (see Serial Interface Timing and Register Listing sections). When the loop is disabled, the Clamp Level Register may still be used to provide programmable offset adjustment.

The optical black clamp is controlled by the CLPOB signal, which is fully programmable (see Horizontal Clamping and Blanking section). System timing examples are shown in the Horizontal Timing Sequence Example section. The CLPOB pulse should be placed during the CCD’s optical black pixels. It is recommended that the CLPOB pulse duration be at least 20 pixels wide. Shorter pulsewidths may be used, but the ability to track low frequency variations in the black level will be reduced.

A/D Converter

The AD9891 uses a high performance 10-bit ADC architecture, optimized for high speed and low power, while the AD9895 uses a 12-bit ADC architecture. Differential nonlinearity (DNL) performance is typically better than 0.5 LSB for both products. The ADC uses a 2 V input range. Better noise performance results from using a larger ADC full-scale range.

AD9891/AD9895

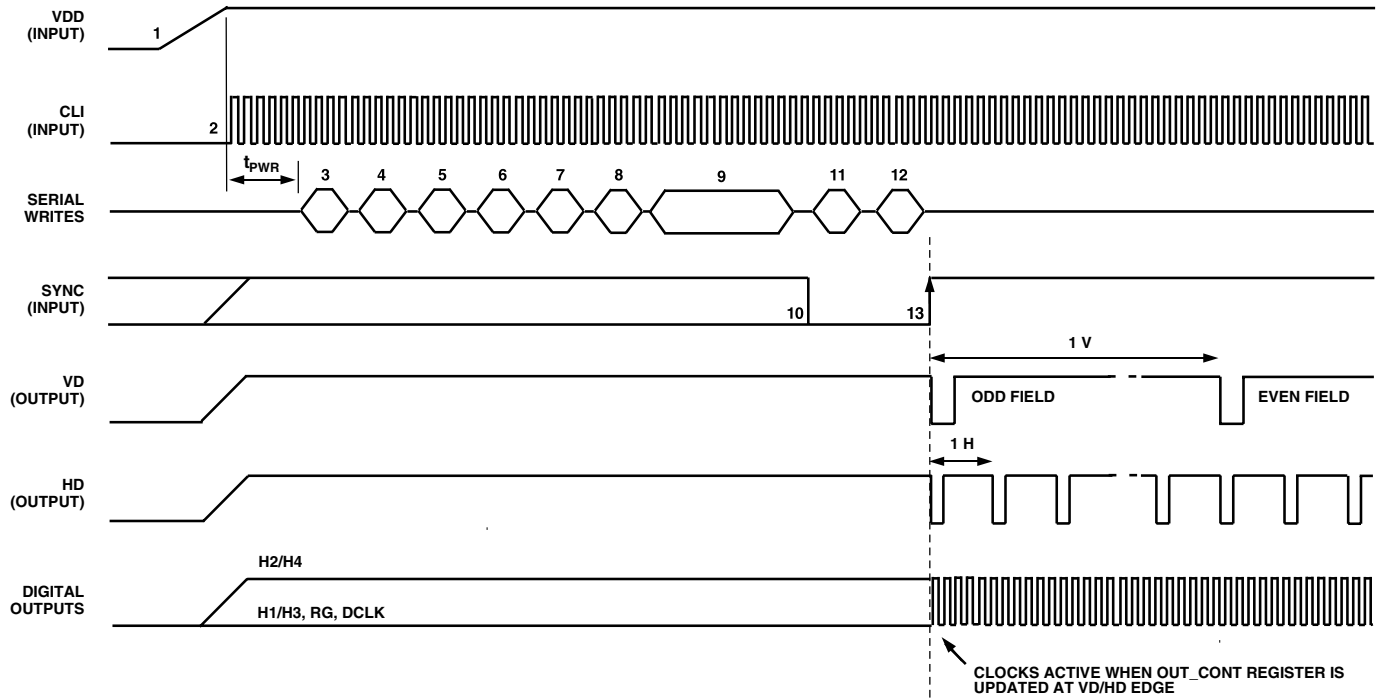

Figure 42. Recommended Power-Up Sequence and Synchronization, Master Mode

POWER-UP AND SYNCHRONIZATION

Recommended Power-Up Sequence for Master Mode

When the AD9891/AD9895 are powered up, the following sequence is recommended (refer to Figure 42 for each step).

1. Turn on power supplies for the AD9891/AD9895.
2. Apply the master clock input CLI.
3. Reset and initialize the internal AD9891/AD9895 Registers. First, write a “1” to the SW_RESET Register (Addr x017) followed by a “0” to the same register. Next, write “110101” (53 decimal) to the INITIAL1 Register (Addr x02B) followed by “000100” (4 decimal) to the INITIAL2 Register (Addr x010). This sequence of writes must always be done in the proper order:

Addr x017	Data 000001
Addr x017	Data 000000
Addr x02B	Data 110101
Addr x010	Data 000100
4. Configure the AD9891/AD9895 for Master Mode timing by writing a “1” to the MASTER Register (Addr x0EB).
5. By default, the internal timing core is held in a reset state with TGCORE_RSTB Register = “0.” Write a “1” to the TGCORE_RSTB Register (Addr x029) to start the internal timing core operation.
6. Write a “1” to the PREVENTUPDATE Register (Addr x01B). This will prevent any updating of the serial register data.
7. Write a “1” to the SYNCENABLE Register (Addr x024). This will allow the external SYNC to be used.
8. Write a “1” to the SYNCSPEND Register (Addr x026). This will cause the outputs to be suspended during the SYNC operation (see Figure 43).

9. Write to desired registers to configure high speed timing, horizontal timing, vertical timing, and shutter timing.
10. If SYNC is HIGH at power-up, then bring SYNC input LOW. Also, SYNC may be held low from power-up.
11. Write a “1” to the OUT_CONT Register (Addr x018). This will allow the outputs to become active after SYNC rising edge.
12. Write a “0” to the PREVENTUPDATE Register (Addr x01B). This will allow the serial information to be updated at the next VD/HD falling edge.
13. Bring SYNC back HIGH. This will cause the internal counters to reset to “0” and start VD/HD operation. VD/HD edge allows register updates to occur, including OUT_CONT, which enables all clock outputs.

SYNC During Master Mode Operation

The SYNC input may be used any time during operation to resync the AD9891/AD9895 counters with external timing, as shown in Figure 43. The operation of the digital outputs may be suspended during the SYNC operation by setting the SYNCSPEND Register (Addr x026) to a “1.”

Synchronization in Slave Mode

When the AD9891/AD9895 is used in Slave Mode, the VD and HD inputs are used to synchronize the internal counters. Following a falling edge of VD, there will be a latency of eight master clock cycles (CLI) after the falling edge of HD until the internal H-counter will be reset. The reset operation is shown in Figure 44.

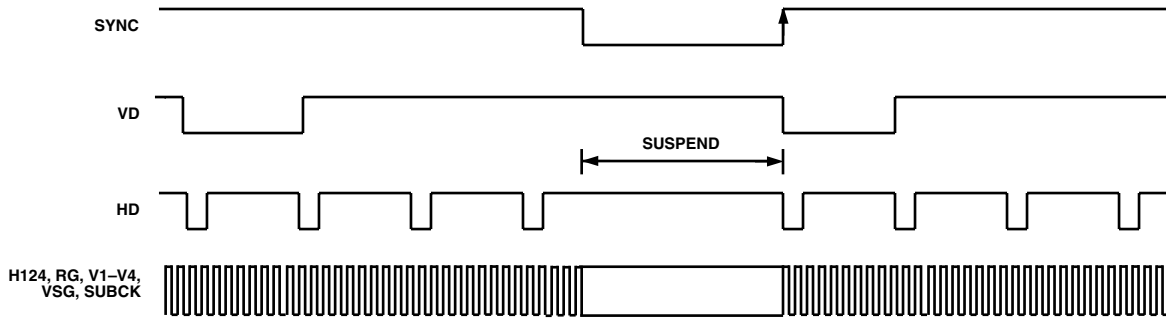

- NOTES
1. SYNC RISING EDGE RESETS VD/HD AND COUNTERS TO ZERO.
 2. SYNC POLARITY IS PROGRAMMABLE USING SYNCPOL REGISTER (ADDR x025).
 3. DURING SYNC LOW, ALL INTERNAL COUNTERS ARE RESET AND VD/HD CAN BE SUSPENDED USING THE SYNCSPEND REGISTER (ADDR x026).
 4. IF SYNCSPEND = 1, VERTICAL CLOCKS AND H1-H2, RG ARE HELD AT THEIR DEFAULT POLARITIES.
 5. IF SYNCSPEND = 0, THEN ALL CLOCK OUTPUTS CONTINUE TO OPERATE NORMALLY UNTIL SYNC RESET EDGE.

Figure 43. SYNC Timing to Synchronize AD989x with External Timing

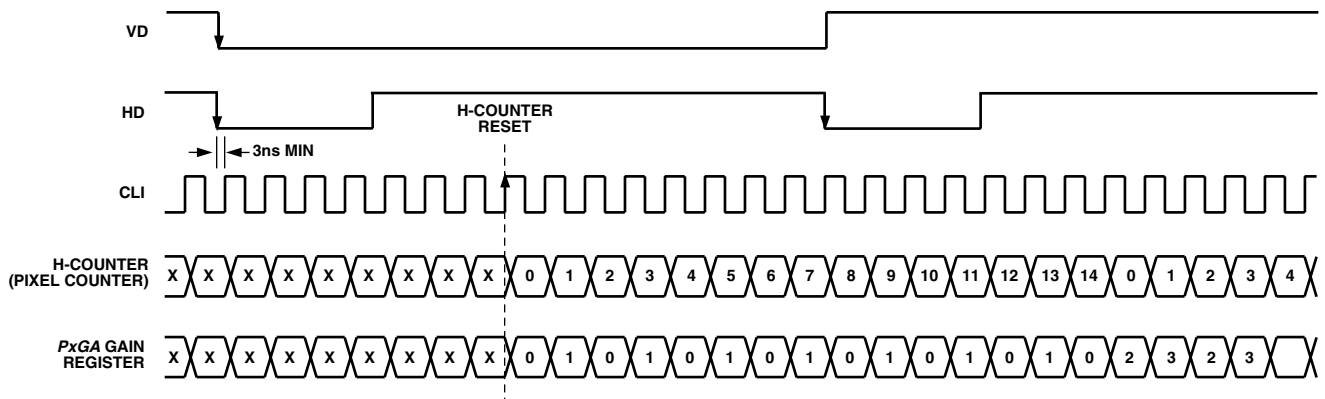

- NOTES
1. INTERNAL H-COUNTER IS RESET 8 CLOCK CYCLES AFTER THE HD FALLING EDGE.
 2. PxGA STEERING IS SYNCHRONIZED WITH THE RESET OF THE INTERNAL H-COUNTER (MOSAIC SEPARATE MODE IS SHOWN).

Figure 44. External VD/HD and Internal H-Counter Synchronization, SLAVE Mode

POWER-DOWN MODE OPERATION

The AD9891/AD9895 contain three different power-down modes to optimize the overall power dissipation in a particular application. Bits [1:0] of the OPRMODE Register control the power-down state of the device:

- OPR_MODE [1:0] = 00 = Normal Operation (full power)
- OPR_MODE[1:0] = 01 = Power-Down 1 Mode
- OPR_MODE[1:0] = 10 = Power-Down 2 Mode
- OPR_MODE[1:0] = 11 = Power-Down 3 Mode (lowest overall power)

Table XVI summarizes the operation of each power-down mode. Note that in any mode, the OUT_CONT Register takes priority over the power-down modes where the digital output states are concerned. Power-Down 3 Mode has the lowest power consumption, and it even powers down the crystal oscillator circuit between CLI and CLO. Thus, if CLI and CLO are being used with a crystal to generate the master clock, this circuit will be powered down and there will be no clock signal. When returning from Power-Down 3 Mode to normal operation, the timing core must be reset at least 500 ms after the OPR_MODE Register is written to. This will allow sufficient time for the crystal circuit to settle.

AD9891/AD9895

Table XVI. Power-Down Mode Operation

I/O Block	OUT_CONT== LOW ¹	Power-Down 1 ¹	Power-Down 2 ^{1, 2}	Power-Down 3 ^{1, 3, 4}
AFE	ON	OFF	OFF	OFF
Timing Core	ON	ON	OFF	OFF
CLO Oscillator	ON	ON	ON	OFF
V1	LOW	LOW	LOW	LOW
V2	LOW	LOW	LOW	LOW
V3	HIGH	HIGH	HIGH	LOW
V4	HIGH	HIGH	HIGH	LOW
VSG1	HIGH	HIGH	HIGH	LOW
VSG2	HIGH	HIGH	HIGH	LOW
VSG3	HIGH	HIGH	HIGH	LOW
VSG4	HIGH	HIGH	HIGH	LOW
VSG5	HIGH	HIGH	HIGH	LOW
VSG6	HIGH	HIGH	HIGH	LOW
VSG7	HIGH	HIGH	HIGH	LOW
VSG8	HIGH	HIGH	HIGH	LOW
SUBCK	HIGH	HIGH	HIGH	LOW
VSUB	LOW	LOW	LOW	LOW
MSHUT	LOW	LOW	LOW	LOW
STROBE	LOW	LOW	LOW	LOW
H1	LOW	LOW	LOW (3.5 mA)	Hi-Z
H2	HIGH	HIGH	HIGH (3.5 mA)	Hi-Z
H3	LOW	LOW	LOW (3.5 mA)	Hi-Z
H4	HIGH	HIGH	HIGH (3.5 mA)	Hi-Z
RG	LOW	LOW	LOW (3.5 mA)	Hi-Z
LD/FD	LOW	LOW	LOW	LOW
CLPOB/ PBLK	HIGH	HIGH	HIGH	LOW
VD	vdhdpol	running	vdhdpol	LOW
HD	vdhdpol	running	vdhdpol	LOW
DCLK	LOW	running	LOW	LOW
CLO	running	running	running	HIGH
DOUT	LOW	LOW	LOW	LOW

NOTES

¹First column represents the defaults when OUT_CONT==LO (OUT_CONT takes precedence). Power-Down 1, 2, and 3 are direct decodes of the OPRMODE Register Bits [1:0]. These polarities assume OUT_CONT==HI.

²Power-Down 2 will set H[1,2,3,4]DRV and RGDRV to 3'h1 (3.5 mA). Power-Down 3 will three-state the H and RG clocks (set H[1,2,3,4]DRV and RGDRV to 3'h0).

³Both the Timing Core and the CLO Oscillator will be powered down in Power-Down 3.

⁴To exit Power-Down 3, first write a 2'b00 to OPRMODE[1:0] (will wake up the oscillator and the timing core), then reset the timing core after ~500µs to guarantee lock.

HORIZONTAL TIMING SEQUENCE EXAMPLE

Figure 45 shows an example CCD layout. The horizontal register contains 28 dummy pixels that will occur on each line clocked from the CCD. In the vertical direction, there are 10 optical black (OB) lines at the front of the readout and two at the back of the readout. The horizontal direction has four OB pixels in the front and 48 in the back.

To configure the AD9891/AD9895 horizontal signals for this CCD, three sequences can be used. Figure 46 shows the first sequence to be used during vertical blanking. During this time, there are no valid OB pixels from the sensor, so the CLPOB and

CLPDM signals are not used. In some cases, if the horizontal clocks are used during this time, the CLPDM signal may be used to keep the AD9891/AD9895's input clamp partially settled. PBLK may be enabled during this time because no valid data is available.

Figure 47 shows the recommended sequence for the vertical OB interval. The clamp signals are used across the whole lines in order to stabilize the clamp loops of the AD9891/AD9895.

Figure 48 shows the recommended sequence for the effective pixel readout. The 48 OB pixels at the end of each line are used for the CLPOB and CLPDM signals.

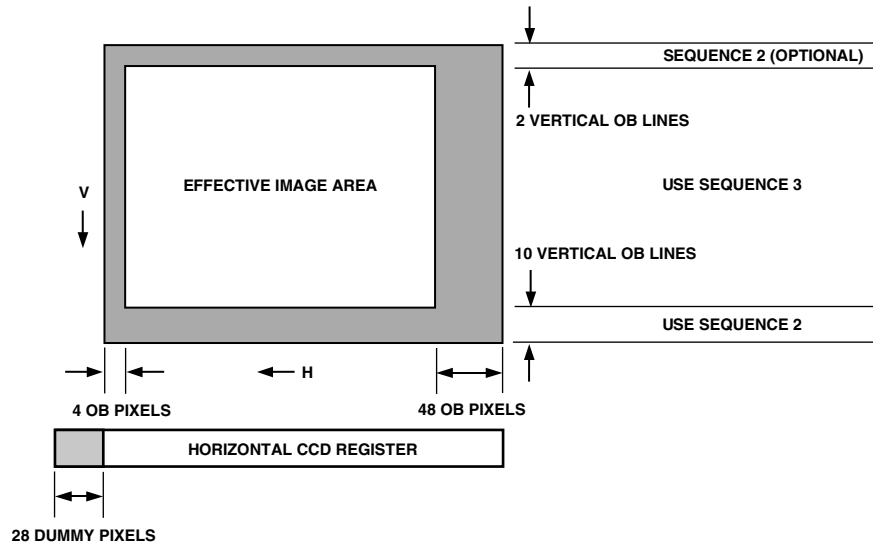
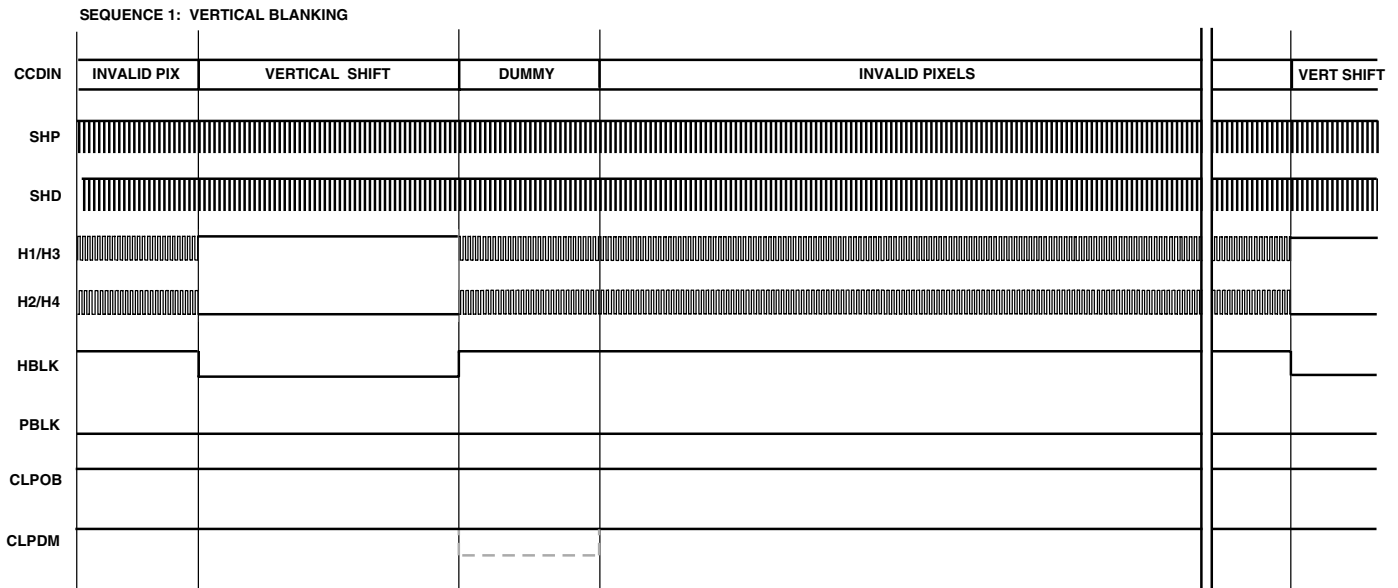

Figure 45. Example CCD Configuration



CLPDM PULSE MAY BE USED DURING HORIZONTAL DUMMY PIXELS IF THE H-CLOCKS ARE USED DURING VERTICAL BLANKING.

Figure 46. Horizontal Sequences During Vertical Blanking

AD9891/AD9895

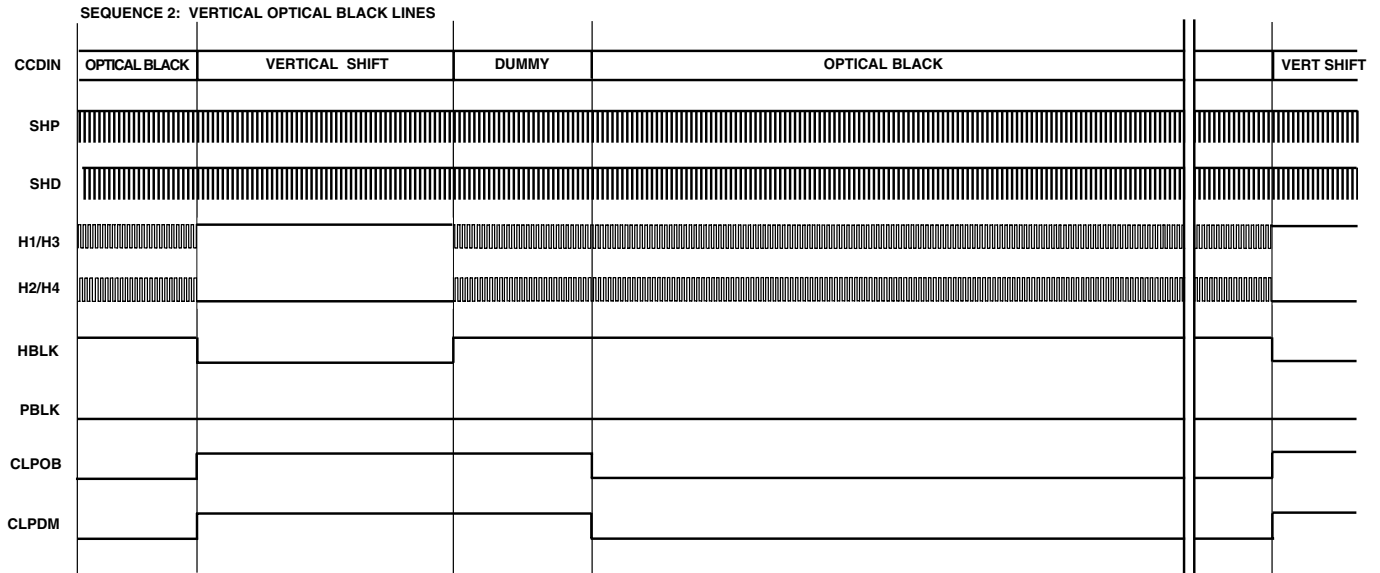

Figure 47. Horizontal Sequences During Vertical Optical Black Pixels

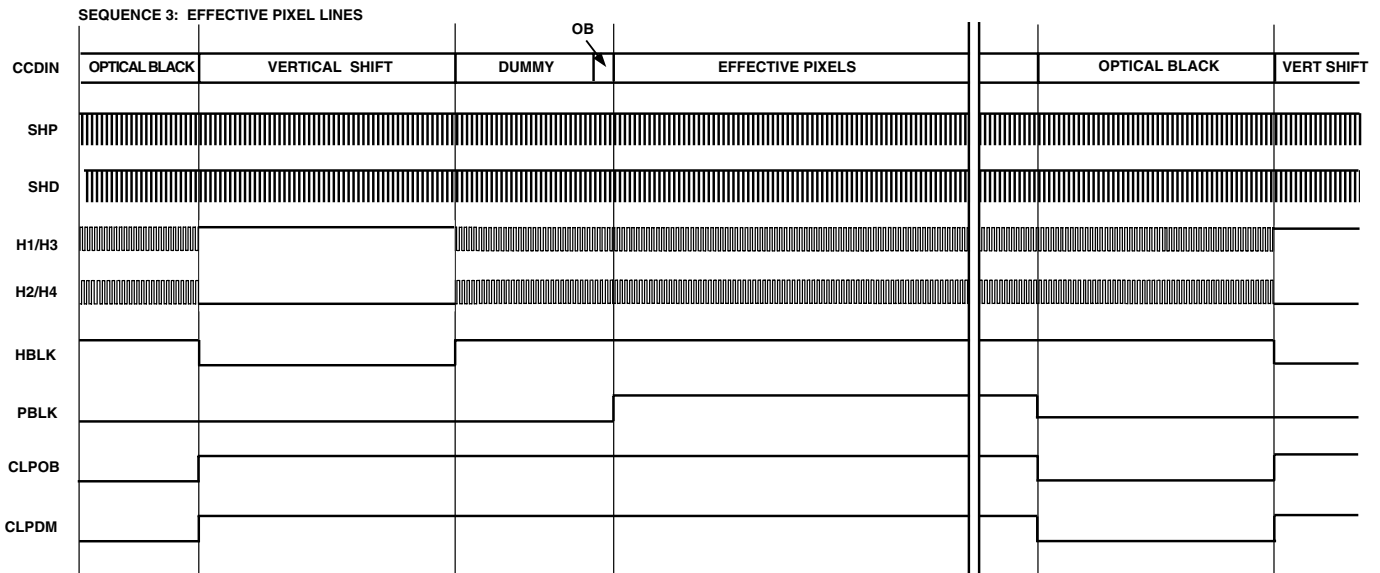

Figure 48. Horizontal Sequences During Effective Pixels

VERTICAL TIMING EXAMPLE

Figure 49 shows an example CCD timing chart for an interlaced readout. Each field can be broken down into four separate region areas. The vertical region change positions (RCPs) will set the line boundaries for each region area, and the region pointers will assign a unique region to each region area.

Region Area 0 is a high speed vertical shift region. Sweep Mode can be used to generate this timing operation, with the desired number of high speed vertical pulses needed to “clean” the charge from the CCD’s vertical registers.

Region Area 1 consists of only two lines and uses standard single line vertical shift timing. The timing of this region area will be the same as the timing in Region Area 3.

Region Area 2 is the sensor gate line, where the VSG pulses transfer the image into the vertical CCD registers. This region will require the use of the second vertical sequence for SG lines.

Region Area 3 also uses the standard single line vertical shift timing, the same timing as Region Area 1.

In summary, three unique regions are required to support the four region areas, since Region Areas 1 and 3 use the same timing.

Some of the timing parameters will need to be adjusted to read out the second field, such as the sensor gate pulse and line location.

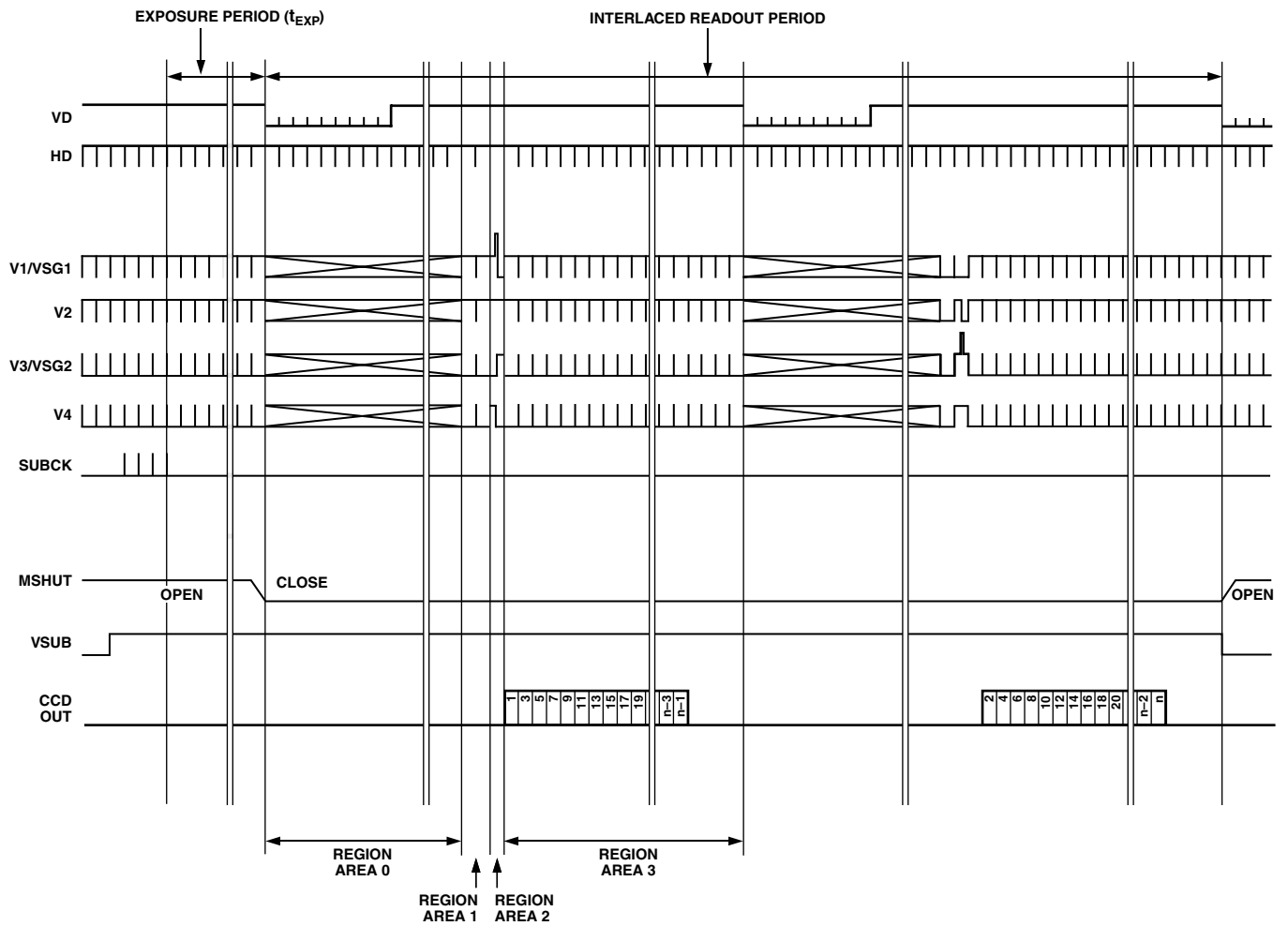

Figure 49. Vertical Timing Example—Separate Regions

AD9891/AD9895

CIRCUIT LAYOUT INFORMATION

The AD9891/AD9895 Typical Circuit Connection is shown in Figure 50. Note that Pins E1 and E2 will be No Connects when using the AD9891. The PCB layout is critical in achieving good image quality from the AD989x products. All of the supply pins, particularly the AVDD1, TCVDD, RGVDD, and HVDD supplies, must be decoupled to ground with good quality high frequency chip capacitors. The decoupling capacitors should be located as close as possible to the supply pins and should have a very low impedance path to a continuous ground plane. There should also be a 4.7 μF or larger value bypass capacitor for each main supply—AVDD, RGVDD, HVDD, and DRVDD—although this is not necessary for each individual pin. In most applications, it is easier to share the supply for RGVDD and HVDD, which may be done as long as the individual supply pins are separately bypassed. A separate 3 V supply may also be used for DRVDD, but this supply pin should still be decoupled to the same ground plane as the rest of the chip. A separate ground for DRVSS is not recommended.

The analog bypass pins (BYP1–3, VRB, VRT) should also be carefully decoupled to ground as close as possible to their respective pins. The analog input (CCDIN) capacitor should also be located close to the pin.

The H1–H4 and RG traces should be designed to have low inductance to avoid excessive distortion of the signals. Heavier traces are recommended because of the large transient current demand on H1–H4 by the CCD. If possible, physically locating the AD9891/AD9895 closer to the CCD will reduce the inductance on these lines. As always, the routing path should be as direct as possible from the AD9891/AD9895 to the CCD.

The AD9891/AD9895 also contains an on-chip oscillator for driving an external crystal. Figure 51 shows an example application using a typical 18 MHz crystal. For the exact values of the external resistors and capacitors, it is best to consult with the crystal manufacturer's data sheet.

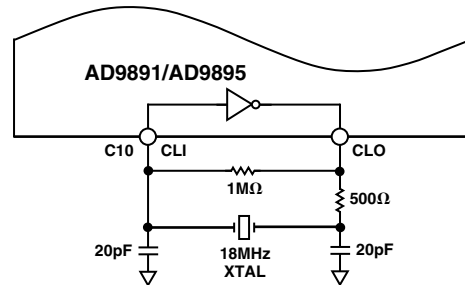

Figure 51. Crystal Driver Application

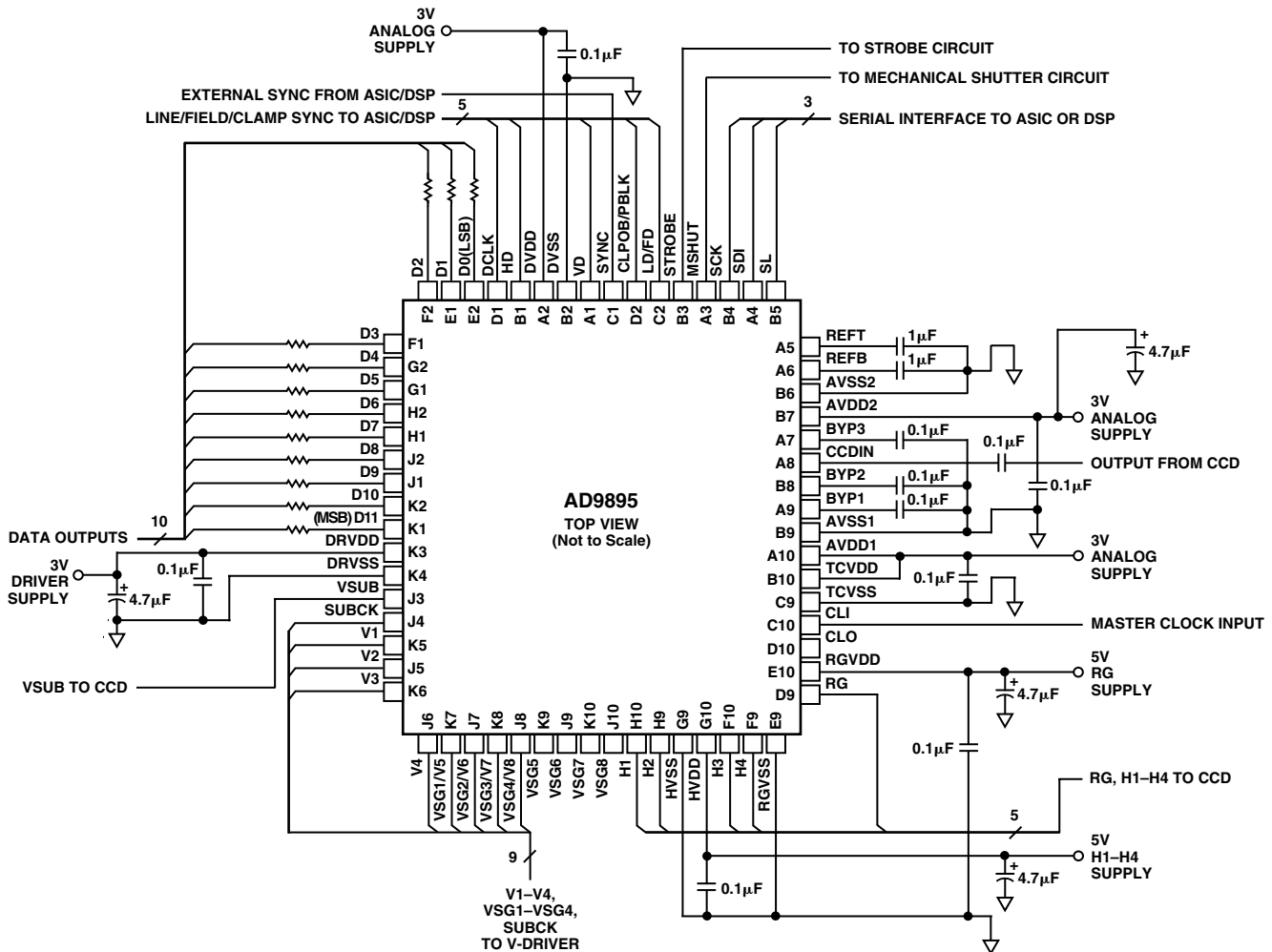

Figure 50. AD9891/AD9895 Typical Circuit Configuration

SERIAL INTERFACE TIMING

All of the internal registers of the AD9891/AD9895 are accessed through a 3-wire serial interface. Each register consists of a 10-bit address and a 6-bit data-word. Both the 10-bit address and 6-bit data-word are written starting with the LSB. To write to each register, a 16-bit operation is required, as shown in Figure 52. Although many registers are less than six bits wide, all six bits must be written to for each register. If the register is only two bits wide, then the upper four bits are Don't Cares and can be filled with 0s during the serial write operation. If less than six bits are written, the register will not be updated with new data.

Because of the large number of registers in the AD9891/AD9895, Figure 53 shows a more efficient way to write to the registers, using the AD9891/AD9895's address auto-increment capability. Using this method, the lowest desired address is written first, followed by multiple 6-bit data-words. Each new 6-bit data-word will automatically be written to the next highest register address. By eliminating the need for each 10-bit address to be written, faster register loading is accomplished. Address auto-increment may be used starting with any register location and may be used to write to as few as two registers or as many as the entire register space.

Notes About Accessing a Double-Wide Register

There are many double-wide registers in the AD9891/AD9895. These registers are configured into two consecutive 6-bit registers with the least significant six bits located in the lower of the two addresses and the remaining most significant

bits located in the higher of the two addresses. For example, the six LSBs of the OPRMODE Register, OPRMODE[5:0], are located at Addr 0x00. The most significant six bits of the OPRMODE Register, OPRMODE[11:6], are located at Addr 0x1. The following rules must be followed when accessing double-wide registers:

1. When accessing a double-wide register, BOTH addresses must be written to.
2. The lower of the two consecutive addresses for the double-wide register must be written to first. In the example of the OPRMODE Register, the contents of Addr 0x00 must be written first followed by the contents of Addr 0x01. The register will be internally updated after the completion of the write to Register 0x01, either at the next SL rising edge or the next VD/HD falling edge depending on the register.
3. A single write to the lower of the two consecutive addresses of a double-wide register that is not followed by a write to the higher address of the registers is not supported. This will not update the register.
4. A single write to the higher of the two consecutive addresses of a double-wide register that is not preceded by a write to the lower of the two addresses is not supported. Although the write to the higher address will update the full double-wide register, the lower six bits of the register will be written with an indeterminate value if the lower address was not written to first.

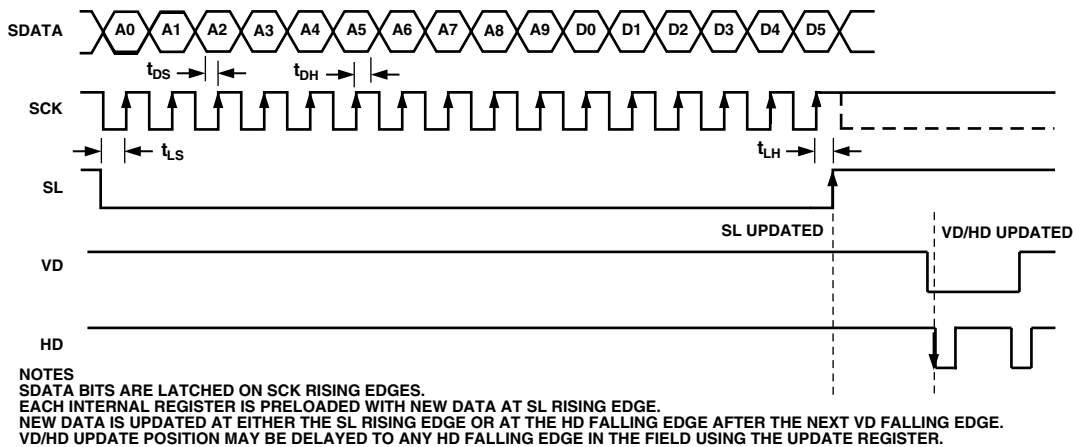

Figure 52. Serial Write Operation

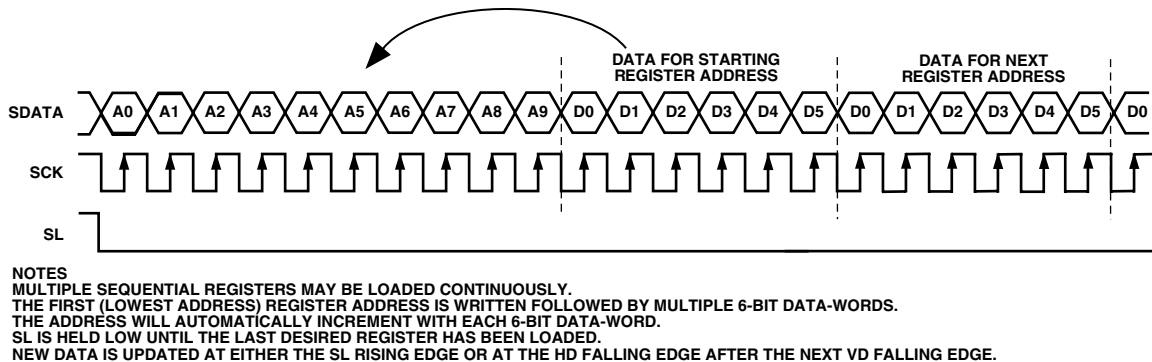

Figure 53. Continuous Serial Write Operation

AD9891/AD9895

NOTES ON REGISTER LISTING

1. Registers larger than six bits occupy two adjacent addresses. When writing to these registers, the lower address containing the least significant data bits should be written to first. The data for both addresses should be written to avoid corruption of register data.
2. All addresses and default values are expressed in hexadecimal.
3. All registers are VD/HD updated as shown in Figure 52, except for the registers indicated in Table XVII, which are SL updated.
4. The registers indicated in Table XVIII are not updated by SL or VD/HD, but are updated at the HD line following the VSG line.

Table XVIII. SG-Line Updated Registers

Register	Description
SUBCKPOL	SUBCK Start Polarity
SUBCK1TOG1	SUBCK First Toggle Position
SUBCK1TOG2	SUBCK Second Toggle Position
SUBCK2TOG1	Second SUBCK First Toggle Position
SUBCK2TOG2	Second SUBCK Second Toggle Position
SUBCKNUM	Total Number of SUBCKs per Field
SUBCKSUPPRESS	Number of SUBCKs to Suppress after VSG Line

Table XVII. SL-Updated Register

Register	Description
OPRMODE	AFE Operation Modes
CTLMODE	AFE Control Modes
SW_RESET	Software Reset Bit
READBACK	Enables Serial Register Readback Mode
FIELDVAL	Resets Internal Field Pulse.
H1HBLKRETIME	Retimes the H1 HBLK to Internal Clock
H3HBLKRETIME	Retimes the H3 HBLK to Internal Clock
SYNCENABLE	External Synchronization Enable
SYNCPOL	External SYNC Active Polarity
SYNCSUSPEND	SYNC Suspend while Active
TG_CORE RSTB	Reset Bar Signal for Internal TG Core
FFTRANCCD	Frame Transfer CCD Mode
H12POL	H1/H2 Polarity Control
H1POSLOC	H1 Positive Edge Location
H1NEGLOC	H1 Negative Edge Location
H34POL	H3/H4 Polarity Control
H3POSLOC	H3 Positive Edge Location
H3NEGLOC	H3 Negative Edge Location
H1DRV	H1 Drive Current
H2DRV	H2 Drive Current
H3DRV	H3 Drive Current
H4DRV	H4 Drive Current
RGPOL	RG Polarity
RGPOSLOC	RG Positive Edge Location
RGNEGLOC	RG Negative Edge Location
SHPLOC	SHP Sample Location
SHDLOC	SHD Sample Location
MASTER	VD/HD Master/Slave Timing Mode
VDHDPOL	VD/HD Active Polarity
SINGLE_CLAMP	Sets CLPDM = CLPOB
DOUT_DELAY	Sets the Output Delay of DOUT
OSC_PWRDOWN	Powers Down the CLO Oscillator
VDHDPOL	VD/HD Active Polarity

Table XIX. AFE Register Map

Address	Content	Bit Width	Default Value	Register Name	Register Description
00	[5:0]	6	10	OPRMODE[5:0]	AFE Operation Mode (See Table XXXI.)
01	[1:0]	2	00	OPRMODE[7:6]	
02	[5:0]	6	05	CCDGAIN[5:0]	VGA Gain (Defaults to 2 dB)
03	[3:0]	4	01	CCDGAIN[9:6]	
04	[5:0]	6	00	REFBLACK[5:0]	Black Clamp Level
05	[1:0]	2	02	REFBLACK[7:6]	
06	[5:0]	6	00	CTLMODE	Control Mode (See Table XXXI.)
07	[5:0]	6	00	PXGA GAIN0	PxGA Color 0 Gain
08	[5:0]	6	00	PXGA GAIN1	PxGA Color 1 Gain
09	[5:0]	6	00	PXGA GAIN2	PxGA Color 2 Gain
0A	[5:0]	6	00	PXGA GAIN3	PxGA Color 3 Gain

Table XX. MISCELLANEOUS/EXTRA Register Map

Address	Content	Bit Width	Default Value	Register Name	Register Description
010	[5:0]	6	00	INTIAL2	See Power-Up Sequence. Should be set to "4."
017	[0]	1	00	SW_RESET	Software Reset (1 = Reset All Registers to Default)
018	[0]	1	00	OUT_CONT	Output Control (0 = Make All Outputs DC Inactive)
019	[5:0]	6	00	UPDATE[5:0]	Serial Data Update Control. Sets the line (HD) within the field for the serial data update to occur.
01A	[5:0]	6	00	UPDATE[11:6]	
01B	[0]	1	00	PREVENTUPDATE	Prevents the Update of the VD Updated Registers
01C	[0]	1	00	READBACK	Serial Interface Readback Enable
01D	[5:0]	6	00	DOUTPHASE	DOUT Phase Control
01E	[0]	1	00	DCLKMODE	DCLK Mode (0 = DCLK Tracks DOUT Phase, 1 = DCLK Is CLO, i.e., CLI Inverse)
01F	[0]	1	00	CLIDIVIDE	Divide CLI Input Clock by 2
020	[0]	1	00	DISABLERESTORE	Disable CCDIN DC Restore Circuit during PBLK (1 = Disable)
021	[0]	1	01	FIELDVAL	Reset Internal Field Pulse Value (0 = Next Field Odd, 1 = Next Field Even)
022	[0]	1	00	H1HBLKRETIME	Re-time H1/H2 HBLK to Internal H1 Clock
023	[0]	1	00	H3HBLKRETIME	Re-time H3/H4 HBLK to Internal H3 Clock
024	[0]	1	00	SYNCENABLE	External Synchronization Enable (1 = Enable)
025	[0]	1	00	SYNCPOL	SYNC Active Polarity (0 = Active LOW)
026	[0]	1	00	SYNCSUSPEND	Suspend Clocks during SYNC Active (1 = Suspend)
027	[0]	1	00	OUTPUTLD	Assign LD/FD Output (0 = FD, 1 = LD)
028	[0]	1	00	OUTPUTPBLK	Assign CLPOB/PBLK Output (0 = CLPOB, 1 = PBLK)
029	[0]	1	00	TG CORE_RSTB	TG Core Reset_bar (0 = Hold TG Core in Reset, 1 = Resume Operation)
02A	[0]	1	00	FTRANCCD	Frame Transfer CCD Mode (1 = VSG1-VSG4 Become V5-V8 Out)
02B	[5:0]	6	00	INTIAL1	See Power-Up Sequence. Should be set to "53."
031	[0]	1	01	SINGLE_CLAMP	CLPDM = CLPOB when Set to 1 (Only CLPOB Registers Used).
032	[1:0]	2	02	DOUT_DELAY	Delay from DCLK to DOUT (0 = No Delay, 1 = 4 ns, 2 = 8 ns, 3 = 12 ns)
033	[0]	1	01	OSC_PWRDOWN	CLO Oscillator Power-Down (0 = Oscillator Is Powered Down)

Table XXI. CLPDM/CLPOB Shared Register Map

Address	Content	Bit Width	Default Value	Register Name	Register Description
064		0	00	CLPSCP0	CLPOB/DM Sequence-Change Position #0 (Hard-Coded to 0)
065	[5:0]	6	3F	CLPSCP1[5:0]	CLPOB/CLPDM Sequence-Change Position #1
066	[5:0]	6	3F	CLPSCP1[11:6]	
067	[5:0]	6	3F	CLPSCP2[5:0]	CLPOB/CLPDM Sequence-Change Position #2
068	[5:0]	6	3F	CLPSCP2[11:6]	
069	[5:0]	6	3F	CLPSCP3[5:0]	CLPOB/CLPDM Sequence-Change Position #3
06A	[5:0]	6	3F	CLPSCP3[11:6]	
06B	[5:0]	6	3F	CLPMASK0[5:0]	CLPOB/CLPDM Masking Line #0
06C	[5:0]	6	3F	CLPMASK0[11:6]	
06D	[5:0]	6	3F	CLPMASK1[5:0]	CLPOB/CLPDM Masking Line #1
06E	[5:0]	6	3F	CLPMASK1[11:6]	
06F	[5:0]	6	3F	CLPMASK2[5:0]	CLPOB/CLPDM Masking Line #2
070	[5:0]	6	3F	CLPMASK2[11:6]	
071	[5:0]	6	3F	CLPMASK3[5:0]	CLPOB/CLPDM Masking Line #3
072	[5:0]	6	3F	CLPMASK3[11:6]	
073	[5:0]	6	3F	CLPMASK4[5:0]	CLPOB/CLPDM Masking Line #4
074	[5:0]	6	3F	CLPMASK4[11:6]	

Table XXII. CLPDM Register Map

Address	Content	Bit Width	Default Value	Register Name	Register Description
075	[0]	1	01	CLPDMSPOL0	Sequence #0: Start Polarity for CLPDM
076	[5:0]	6	2E	CLPDMTOG1_0[5:0]	Sequence #0: Toggle Position 1 for CLPDM
077	[5:0]	6	00	CLPDMTOG1_0[11:6]	
078	[5:0]	6	06	CLPDMTOG2_0[5:0]	Sequence #0: Toggle Position 2 for CLPDM
079	[5:0]	6	03	CLPDMTOG2_0[11:6]	
07A	[0]	1	00	CLPDMSPOL1	Sequence #1: Start Polarity for CLPDM
07B	[5:0]	6	3F	CLPDMTOG1_1[5:0]	Sequence #1: Toggle Position 1 for CLPDM
07C	[5:0]	6	3F	CLPDMTOG1_1[11:6]	
07D	[5:0]	6	3F	CLPDMTOG2_1[5:0]	Sequence #1: Toggle Position 2 for CLPDM
07E	[5:0]	6	3F	CLPDMTOG2_1[11:6]	
07F	[0]	1	00	CLPDMSPOL2	Sequence #2: Start Polarity for CLPDM
080	[5:0]	6	3F	CLPDMTOG1_2[5:0]	Sequence #2: Toggle Position 1 for CLPDM
081	[5:0]	6	3F	CLPDMTOG1_2[11:6]	
082	[5:0]	6	3F	CLPDMTOG2_2[5:0]	Sequence #2: Toggle Position 2 for CLPDM
083	[5:0]	6	3F	CLPDMTOG2_2[11:6]	
084	[0]	1	00	CLPDMSPOL3	Sequence #3: Start Polarity for CLPDM
085	[5:0]	6	3F	CLPDMTOG1_3[5:0]	Sequence #3: Toggle Position 1 for CLPDM
086	[5:0]	6	3F	CLPDMTOG1_3[11:6]	
087	[5:0]	6	3F	CLPDMTOG2_3[5:0]	Sequence #3: Toggle Position 2 for CLPDM
088	[5:0]	6	3F	CLPDMTOG2_3[11:6]	
089	[1:0]	2	00	CLPDMSPTR0	CLPDM Sequence Pointer for Region #0
08A	[1:0]	2	00	CLPDMSPTR1	CLPDM Sequence Pointer for Region #1
08B	[1:0]	2	00	CLPDMSPTR2	CLPDM Sequence Pointer for Region #2
08C	[1:0]	2	00	CLPDMSPTR3	CLPDM Sequence Pointer for Region #3

Table XXIII. CLPOB Register Map

Address	Content	Bit Width	Default Value	Register Name	Register Description
08D	[0]	1	01	CLPOBPOL0	Sequence #0: Start Polarity for CLPOB
08E	[5:0]	6	0A	CLPOBTOG1_0[5:0]	Sequence #0: Toggle Position 1 for CLPOB
08F	[5:0]	6	00	CLPOBTOG1_0[11:6]	
090	[5:0]	6	2F	CLPOBTOG2_0[5:0]	Sequence #0: Toggle Position 2 for CLPOB
091	[5:0]	6	00	CLPOBTOG2_0[11:6]	
092	[0]	1	00	CLPOBPOL1	Sequence #1: Start Polarity for CLPOB
093	[5:0]	6	3F	CLPOBTOG1_1[5:0]	Sequence #1: Toggle Position 1 for CLPOB
094	[5:0]	6	3F	CLPOBTOG1_1[11:6]	
095	[5:0]	6	3F	CLPOBTOG2_1[5:0]	Sequence #1: Toggle Position 2 for CLPOB
096	[5:0]	6	3F	CLPOBTOG2_1[11:6]	
097	[0]	1	00	CLPOBPOL2	Sequence #2: Start Polarity for CLPOB
098	[5:0]	6	3F	CLPOBTOG1_2[5:0]	Sequence #2: Toggle Position 1 for CLPOB
099	[5:0]	6	3F	CLPOBTOG1_2[11:6]	
09A	[5:0]	6	3F	CLPOBTOG2_2[5:0]	Sequence #2: Toggle Position 2 for CLPOB
09B	[5:0]	6	3F	CLPOBTOG2_2[11:6]	
09C	[0]	1	00	CLPOBSPOL3	Sequence #3: Start Polarity for CLPOB
09D	[5:0]	6	3F	CLPOBTOG1_3[5:0]	Sequence #3: Toggle Position 1 for CLPOB
09E	[5:0]	6	3F	CLPOBTOG1_3[11:6]	
09F	[5:0]	6	3F	CLPOBTOG2_3[5:0]	Sequence #3: Toggle Position 2 for CLPOB
0A0	[5:0]	6	3F	CLPOBTOG2_3[11:6]	
0A1	[1:0]	2	00	CLPOBSPTR0	CLPOB Sequence Pointer for Region #0
0A2	[1:0]	2	00	CLPOBSPTR1	CLPOB Sequence Pointer for Region #1
0A3	[1:0]	2	00	CLPOBSPTR2	CLPOB Sequence Pointer for Region #2
0A4	[1:0]	2	00	CLPOBSPTR3	CLPOB Sequence Pointer for Region #3

Table XXIV. HBLK Register Map*

Address	Content	Bit Width	Default Value	Register Name	Register Description
0A5	[0]	1	01	HBLKMASK_H1_0	Sequence #0: H1 Masking Polarity for HBLK
0A6	[0]	1	01	HBLKMASK_H3_0	Sequence #0: H3 Masking Polarity for HBLK
0A7	[5:0]	6	34	HBLKTOG1_0[5:0]	Sequence #0: Toggle Position 1 for HBLK
0A8	[5:0]	6	00	HBLKTOG1_0[11:6]	
0A9	[5:0]	6	2C	HBLKTOG2_0[5:0]	Sequence #0: Toggle Position 2 for HBLK
0AA	[5:0]	6	02	HBLKTOG2_0[11:6]	
0AB	[0]	1	00	HBLKMASK_H1_1	Sequence #1: H1 Masking Polarity for HBLK
0AC	[0]	1	00	HBLKMASK_H3_1	Sequence #1: H3 Masking Polarity for HBLK
0AD	[5:0]	6	3F	HBLKTOG1_1[5:0]	Sequence #1: Toggle Position 1 for HBLK
0AE	[5:0]	6	3F	HBLKTOG1_1[11:6]	
0AF	[5:0]	6	3F	HBLKTOG2_1[5:0]	Sequence #1: Toggle Position 2 for HBLK
0B0	[5:0]	6	3F	HBLKTOG2_1[11:6]	
0B1	[0]	1	00	HBLKMASK_H1_2	Sequence #2: H1 Masking Polarity for HBLK
0B2	[0]	1	00	HBLKMASK_H3_2	Sequence #2: H3 Masking Polarity for HBLK
0B3	[5:0]	6	3F	HBLKTOG1_2[5:0]	Sequence #2: Toggle Position 1 for HBLK
0B4	[5:0]	6	3F	HBLKTOG1_2[11:6]	
0B5	[5:0]	6	3F	HBLKTOG2_2[5:0]	Sequence #2: Toggle Position 2 for HBLK
0B6	[5:0]	6	3F	HBLKTOG2_2[11:6]	
0B7	[0]	1	00	HBLKMASK_H1_3	Sequence #3: H1 Masking Polarity for HBLK
0B8	[0]	1	00	HBLKMASK_H3_3	Sequence #3: H3 Masking Polarity for HBLK
0B9	[5:0]	6	3F	HBLKTOG1_3[5:0]	Sequence #3: Toggle Position 1 for HBLK
0BA	[5:0]	6	3F	HBLKTOG1_3[11:6]	
0BB	[5:0]	6	3F	HBLKTOG2_3[5:0]	Sequence #3: Toggle Position 2 for HBLK
0BC	[5:0]	6	3F	HBLKTOG2_3[11:6]	

*HBLK Sequence-Change Positions shared with the vertical transfer pulses.

Table XXV. PBLK Register Map

Address	Content	Bit Width	Default Value	Register Name	Register Description
0BD	[0]	1	00	PBLKSPOL0	Sequence #0: Start Polarity for PBLK
0BE	[5:0]	6	10	PBLKTOG1_0[5:0]	Sequence #0: Toggle Position 1 for PBLK
0BF	[5:0]	6	03	PBLKTOG1_0[11:6]	
0C0	[5:0]	6	3F	PBLKBTOG2_0[5:0]	Sequence #0: Toggle Position 2 for PBLK
0C1	[5:0]	6	3F	PBLKBTOG2_0[11:6]	
0C2	[0]	1	00	PBLKSPOL1	Sequence #1: Start Polarity for PBLK
0C3	[5:0]	6	3F	PBLKTOG1_1[5:0]	Sequence #1: Toggle Position 1 for PBLK
0C4	[5:0]	6	3F	PBLKTOG1_1[11:6]	
0C5	[5:0]	6	3F	PBLKTOG2_1[5:0]	Sequence #1: Toggle Position 2 for PBLK
0C6	[5:0]	6	3F	PBLKTOG2_1[11:6]	
0C7	[0]	1	00	PBLKSPOL2	Sequence #2: Start Polarity for PBLK
0C8	[5:0]	6	3F	PBLKTOG1_2[5:0]	Sequence #2: Toggle Position 1 for PBLK
0C9	[5:0]	6	3F	PBLKTOG1_2[11:6]	
0CA	[5:0]	6	3F	PBLKTOG2_2[5:0]	Sequence #2: Toggle Position 2 for PBLK
0CB	[5:0]	6	3F	PBLKTOG2_2[11:6]	
0CC	[0]	1	00	PBLKSPOL3	Sequence #3: Start Polarity for PBLK
0CD	[5:0]	6	3F	PBLKTOG1_3[5:0]	Sequence #3: Toggle Position 1 for PBLK
0CE	[5:0]	6	3F	PBLKTOG1_3[11:6]	
0CF	[5:0]	6	3F	PBLKTOG2_3[5:0]	Sequence #3: Toggle Position 2 for PBLK
0D0	[5:0]	6	3F	PBLKTOG2_3[11:6]	
		0	00	PBLKSCP0	PBLK Sequence-Change Position #0 (Hard-Coded to 0)
0D1	[1:0]	2	00	PBLKSPTR0	PBLK Sequence Pointer for Region #0
0D2	[5:0]	6	3F	PBLKSCP1[5:0]	PBLK Sequence-Change Position #1
0D3	[5:0]	6	3F	PBLKSCP1[11:6]	
0D4	[1:0]	2	00	PBLKSPTR1	PBLK Sequence Pointer for Region #1
0D5	[5:0]	6	3F	PBLKSCP2[5:0]	PBLK Sequence-Change Position #2
0D6	[5:0]	6	3F	PBLKSCP2[11:6]	
0D7	[1:0]	2	00	PBLKSPTR2	PBLK Sequence Pointer for Region #2
0D8	[5:0]	6	3F	PBLKSCP3[5:0]	PBLK Sequence-Change Position #3
0D9	[5:0]	6	3F	PBLKSCP3[11:6]	
0DA	[1:0]	2	00	PBLKSPTR3	PBLK Sequence Pointer for Region #3

Table XXVI. H1-H4, RG, SHP, SHD Register Map

Address	Content	Bit Width	Default Value	Register Name	Register Description
0DB	[0]	1	01	H12POL	H1/H2 Polarity Control (0 = Inversion, 1 = No Inversion)
0DC	[5:0]	6	00	H1POSLOC	H1 Positive Edge Location
0DD	[5:0]	6	20	H1NEGLOC	H1 Negative Edge Location
0DE	[0]	1	01	H34POL	H3/H4 Polarity Control (0 = Inversion, 1 = No Inversion)
0DF	[5:0]	6	00	H3POSLOC	H3 Positive Edge Location
0E0	[5:0]	6	20	H3NEGLOC	H3 Negative Edge Location
0E1	[2:0]	3	03	H1DRV	H1 Drive Strength (0 = Off, 1 = 3.5 mA, 2 = 7 mA, 3 = 10.5 mA, 4 = 14 mA, 5 = 17.5 mA, 6 = 21 mA, 7 = 24.5 mA)
0E2	[2:0]	3	03	H2DRV	H2 Drive Strength
0E3	[2:0]	3	03	H3DRV	H3 Drive Strength
0E4	[2:0]	3	03	H4DRV	H4 Drive Strength
0E5	[0]	1	01	RGPOL	RG Polarity Control (0 = Inversion, 1 = No Inversion)
0E6	[5:0]	6	00	RGPOSLOC	RG Positive Edge Location
0E7	[5:0]	6	10	RGNEGLOC	RG Negative Edge Location
0E8	[2:0]	3	02	RGDRV	RG Drive Strength (0 = Off, 1 = 3.5 mA, 2 = 7 mA, 3 = 10.5 mA, 4 = 14 mA, 5 = 17.5 mA, 6 = 21 mA, 7 = 24.5 mA)
0E9	[5:0]	6	24	SHPPOSLOC	SHP (Positive) Edge Sampling Location
0EA	[5:0]	6	00	SHDPOSLOC	SHD (Positive) Edge Sampling Location

Table XXVII. HD/VD Register Map

Address	Content	Bit Width	Default Value	Register Name	Register Description
0EB	[0]	1	00	MASTER	VD/HD Master or Slave Timing (0 = Slave, 1 = Master)
0EC	[0]	1	00	VDHDPOL	VD/HD Active Polarity (0 = Low Active, 1 = High Active)
0ED	[5:0]	6	09	VDRISE	VD Rising Edge Location (HD Location in Field)
0EE	[5:0]	6	07	VDLEN[5:0]	VD Field Length (Number of Lines per Field)
0EF	[4:0]	6	04	VDLEN[11:6]	
0F0	[5:0]	6	33	HDRISE[5:0]	HD Rising Edge Location (Pixel Location in Line)
0F1	[5:0]	6	01	HDRISE[11:6]	
0F2	[5:0]	6	38	HDLASTLEN[5:0]	HD Last Line Length (Number of Pixels in Last Line of Field)
0F3	[5:0]	6	11	HDLASTLEN[11:6]	

Table XXVIII. V1-V8 Register Map

Address	Content	Bit Width	Default Value	Register Name	Register Description
0F4	[0]	1	00	VTPPOL0	Sequence #0: Start Polarity
0F5	[5:0]	6	05	VTPTOG1_0[5:0]	Sequence #0: Toggle Position 1
0F6	[5:0]	6	00	VTPTOG1_0[11:6]	
0F7	[5:0]	6	12	VTPTOG2_0[5:0]	Sequence #0: Toggle Position 2
0F8	[5:0]	6	00	VTPTOG2_0[11:6]	
0F9	[5:0]	6	3F	VTPTOG3_0[5:0]	Sequence #0: Toggle Position 3
0FA	[5:0]	6	3F	VTPTOG3_0[11:6]	
0FB	[5:0]	6	24	VTPLEN0[5:0]	Sequence #0: Total Length
0FC	[3:0]	4	00	VTPLEN0[9:6]	
0FD	[5:0]	6	03	VTPREP0[5:0]	Sequence #0: Repetitions
0FE	[11:6]	6	00	VTPREP0[11:6]	
0FF	[0]	1	00	VTPPOL1	Sequence #1: Start Polarity
100	[5:0]	6	17	VTPTOG1_1[5:0]	Sequence #1: Toggle Position 1
101	[5:0]	6	00	VTPTOG1_1[11:6]	
102	[5:0]	6	3F	VTPTOG2_1[5:0]	Sequence #1: Toggle Position 2
103	[5:0]	6	3F	VTPTOG2_1[11:6]	
104	[5:0]	6	3F	VTPTOG3_1[5:0]	Sequence #1: Toggle Position 3
105	[5:0]	6	3F	VTPTOG3_1[11:6]	
106	[5:0]	6	24	VTPLEN1[5:0]	Sequence #1: Total Length
107	[3:0]	4	00	VTPLEN1[9:6]	
108	[5:0]	6	03	VTPREP1[5:0]	Sequence #1: Repetitions
109	[11:6]	6	00	VTPREP1[11:6]	
10A	[0]	1	01	VTPPOL2	Sequence #2: Start Polarity
10B	[5:0]	6	16	VTPTOG1_2[5:0]	Sequence #2: Toggle Position 1
10C	[5:0]	6	02	VTPTOG1_2[11:6]	
10D	[5:0]	6	2C	VTPTOG2_2[5:0]	Sequence #2: Toggle Position 2
10E	[5:0]	6	04	VTPTOG2_2[11:6]	
10F	[5:0]	6	28	VTPTOG3_2[5:0]	Sequence #2: Toggle Position 3
110	[5:0]	6	05	VTPTOG3_2[11:6]	
111	[5:0]	6	28	VTPLEN2[5:0]	Sequence #2: Total Length
112	[3:0]	4	05	VTPLEN2[9:6]	
113	[5:0]	6	01	VTPREP2[5:0]	Sequence #2: Repetitions
114	[11:6]	6	00	VTPREP2[11:6]	
115	[0]	1	01	VTPPOL3	Sequence #3: Start Polarity
116	[5:0]	6	1A	VTPTOG1_3[5:0]	Sequence #3: Toggle Position 1
117	[5:0]	6	01	VTPTOG1_3[11:6]	
118	[5:0]	6	30	VTPTOG2_3[5:0]	Sequence #3: Toggle Position 2
119	[5:0]	6	03	VTPTOG2_3[11:6]	
11A	[5:0]	6	2C	VTPTOG3_3[5:0]	Sequence #3: Toggle Position 3
11B	[5:0]	6	04	VTPTOG3_3[11:6]	

AD9891/AD9895

Table XXVIII. V1-V8 Register Map (continued)

Address	Content	Bit Width	Default Value	Register Name	Register Description
11C	[5:0]	6	2C	VTPLEN3[5:0]	Sequence #3: Total Length
11D	[3:0]	4	04	VTPLEN3[9:6]	
11E	[5:0]	6	01	VTPREP3[5:0]	Sequence #3: Repetitions
11F	[11:6]	6	00	VTPREP3[11:6]	
120	[0]	1	00	VTPPOL4	Sequence #4: Start Polarity
121	[5:0]	6	34	VTPTOG1_4[5:0]	Sequence #4: Toggle Position 1
122	[5:0]	6	02	VTPTOG1_4[11:6]	
123	[5:0]	6	0A	VTPTOG2_4[5:0]	Sequence #4: Toggle Position 2
124	[5:0]	6	05	VTPTOG2_4[11:6]	
125	[5:0]	6	06	VTPTOG3_4[5:0]	Sequence #4: Toggle Position 3
126	[5:0]	6	06	VTPTOG3_4[11:6]	
127	[5:0]	6	06	VTPLEN4[5:0]	Sequence #4: Total Length
128	[3:0]	4	06	VTPLEN4[9:6]	
129	[5:0]	6	01	VTPREP4[5:0]	Sequence #4: Repetitions
12A	[11:6]	6	00	VTPREP4[11:6]	
12B	[0]	1	00	VTPPOL5	Sequence #5: Start Polarity
12C	[5:0]	6	12	VTPTOG1_5[5:0]	Sequence #5: Toggle Position 1
12D	[5:0]	6	03	VTPTOG1_5[11:6]	
12E	[5:0]	6	2C	VTPTOG2_5[5:0]	Sequence #5: Toggle Position 2
12F	[5:0]	6	04	VTPTOG2_5[11:6]	
130	[5:0]	6	28	VTPTOG3_5[5:0]	Sequence #5: Toggle Position 3
131	[5:0]	6	05	VTPTOG3_5[11:6]	
132	[5:0]	6	28	VTPLEN5[5:0]	Sequence #5: Total Length
133	[3:0]	4	05	VTPLEN5[9:6]	
134	[5:0]	6	01	VTPREP5[5:0]	Sequence #5: Repetitions
135	[11:6]	6	00	VTPREP5[11:6]	
136	[0]	1	00	VTPPOL6	Sequence #6: Start Polarity
137	[5:0]	6	3F	VTPTOG1_6[5:0]	Sequence #6: Toggle Position 1
138	[5:0]	6	3F	VTPTOG1_6[11:6]	
139	[5:0]	6	3F	VTPTOG2_6[5:0]	Sequence #6: Toggle Position 2
13A	[5:0]	6	3F	VTPTOG2_6[11:6]	
13B	[5:0]	6	3F	VTPTOG3_6[5:0]	Sequence #6: Toggle Position 3
13C	[5:0]	6	3F	VTPTOG3_6[11:6]	
13D	[5:0]	6	00	VTPLEN6[5:0]	Sequence #6: Total Length
13E	[3:0]	4	00	VTPLEN6[9:6]	
13F	[5:0]	6	00	VTPREP6[5:0]	Sequence #6: Repetitions
140	[11:6]	6	00	VTPREP6[11:6]	
141	[0]	1	00	VTPPOL7	Sequence #7: Start Polarity
142	[5:0]	6	3F	VTPTOG1_7[5:0]	Sequence #7: Toggle Position 1
143	[5:0]	6	3F	VTPTOG1_7[11:6]	
144	[5:0]	6	3F	VTPTOG2_7[5:0]	Sequence #7: Toggle Position 2
145	[5:0]	6	3F	VTPTOG2_7[11:6]	
146	[5:0]	6	3F	VTPTOG3_7[5:0]	Sequence #7: Toggle Position 3
147	[5:0]	6	3F	VTPTOG3_7[11:6]	
148	[5:0]	6	00	VTPLEN7[5:0]	Sequence #7: Total Length
149	[3:0]	4	00	VTPLEN7[9:6]	
14A	[5:0]	6	00	VTPREP7[5:0]	Sequence #7: Repetitions
14B	[11:6]	6	00	VTPREP7[11:6]	
14C	[0]	1	00	VTPPOL8	Sequence #8: Start Polarity
14D	[5:0]	6	3F	VTPTOG1_8[5:0]	Sequence #9: Toggle Position 1
14E	[3:0]	4	3F	VTPTOG1_8[9:6]	
14F	[5:0]	6	3F	VTPTOG2_8[5:0]	Sequence #8: Toggle Position 2
150	[3:0]	4	3F	VTPTOG2_8[9:6]	
151	[5:0]	6	00	VTPLEN8[5:0]	Sequence #8: Total Length
152	[3:0]	4	00	VTPLEN8[9:6]	
153	[5:0]	6	00	VTPREP8	Sequence #8: Repetitions

Table XXVIII. V1-V8 Register Map (continued)

Address	Content	Bit Width	Default Value	Register Name	Register Description
154	[0]	1	00	VTPPOL8	Sequence #9: Start Polarity
155	[5:0]	6	3F	VTPTOG1_9[5:0]	Sequence #9: Toggle Position 1
156	[3:0]	4	3F	VTPTOG1_9[9:6]	
157	[5:0]	6	3F	VTPTOG2_9[5:0]	Sequence #9: Toggle Position 2
158	[3:0]	4	3F	VTPTOG2_9[9:6]	
159	[5:0]	6	00	VTPLEN9[5:0]	Sequence #9: Total Length
15A	[3:0]	4	00	VTPLEN9[9:6]	
15B	[5:0]	6	00	VTPREP9	Sequence #9: Repetitions
15C	[0]	1	00	VTPPOL10	Sequence #10: Start Polarity
15D	[5:0]	6	3F	VTPTOG1_10[5:0]	Sequence #10: Toggle Position 1
15E	[3:0]	4	3F	VTPTOG1_10[6:0]	
15F	[5:0]	6	3F	VTPTOG2_10[5:0]	Sequence #10: Toggle Position 2
160	[3:0]	4	3F	VTPTOG2_10[9:6]	
161	[5:0]	6	00	VTPLEN10[5:0]	Sequence #10: Total Length
162	[3:0]	4	00	VTPLEN10[9:6]	
163	[5:0]	6	00	VTPREP10	Sequence #10: Repetitions
164	[0]	1	00	VTPPOL11	Sequence #11: Start Polarity
165	[5:0]	6	3F	VTPTOG1_11[5:0]	Sequence #11: Toggle Position 1
166	[3:0]	4	3F	VTPTOG1_11[9:6]	
167	[5:0]	6	3F	VTPTOG2_11[5:0]	Sequence #11: Toggle Position 2
168	[3:0]	4	3F	VTPTOG2_11[9:6]	
169	[5:0]	6	00	VTPLEN11[5:0]	Sequence #11: Total Length
16A	[3:0]	4	00	VTPLEN11[9:6]	
16B	[5:0]	6	00	VTPREP11	Sequence #11: Repetitions
		0	00	VTPRCP0	V Region-Change Position #0 (Hard-Coded to 0)
16C	[2:0]	3	00	VTPREGPTR0	V Region Pointer for Sequence-Change Position #0
16D	[5:0]	6	3F	VTPRCP1[5:0]	V Region-Change Position #1
16E	[5:0]	6	3F	VTPRCP1[11:6]	
16F	[2:0]	3	00	VTPREGPTR1	V Region Pointer for Sequence-Change Position #1
170	[5:0]	6	3F	VTPRCP2[5:0]	V Region-Change Position #2
171	[5:0]	6	3F	VTPRCP2[11:6]	
172	[2:0]	3	00	VTPREGPTR2	V Region Pointer for Sequence-Change Position #2
173	[5:0]	6	3F	VTPRCP3[5:0]	V Region-Change Position #3
174	[5:0]	6	3F	VTPRCP3[11:6]	
175	[2:0]	3	00	VTPREGPTR3	V Region Pointer for Sequence-Change Position #3
176	[5:0]	6	3F	VTPRCP4[5:0]	V Region-Change Position #4
177	[5:0]	6	3F	VTPRCP4[11:6]	
178	[2:0]	3	00	VTPREGPTR4	V Region Pointer for Sequence-Change Position #4
179	[5:0]	6	3F	VTPRCP5[5:0]	V Region-Change Position #5
17A	[5:0]	6	3F	VTPRCP5[11:6]	
17B	[2:0]	3	00	VTPREGPTR5	V Region Pointer for Sequence-Change Position #5
17C	[5:0]	6	3F	VTPRCP6[5:0]	V Region-Change Position #6
17D	[5:0]	6	3F	VTPRCP6[11:6]	
17E	[2:0]	3	00	VTPREGPTR6	V Region Pointer for Sequence-Change Position #6
17F	[5:0]	6	3F	VTPRCP7[5:0]	V Region-Change Position #7
180	[5:0]	6	3F	VTPRCP7[11:6]	
181	[2:0]	3	00	VTPREGPTR7	V Region Pointer for Sequence-Change Position #7
182	[0]	1	00	SWEEP0	V Sweep for Region #0
183	[0]	1	00	MULTI0	V Multiplier for Region #0
184	[5:0]	6	30	HDLEN0[5:0]	Region #0 HD Line Length
185	[5:0]	6	23	HDLEN0[11:6]	
186	[1:0]	2	00	HBLKSPTR0	HBLK Sequence for Region #0
187	[0]	1	00	VTPALT0	VTP Sequence Alternation for Region #0
188	[3:0]	4	00	VISPTRFIRST0	V1 Sequence for Region #0 (1st Lines)

Table XXVIII. V1-V8 Register Map (continued)

Address	Content	Bit Width	Default Value	Register Name	Register Description
189	[0]	1	00	V1INVFIRST0	V1 Sequence Inversion for Region #0 (First Lines)
18A	[3:0]	4	00	V1SPTRSECOND0	V1 Sequence for Region #0 (Second Lines)
18B	[0]	1	00	V1INVSECOND0	V1 Sequence Inversion for Region #0 (Second Lines)
18C	[5:0]	6	34	V4_7START4[5:0]	V1 and V5 Sequence Start for Region #0
18D	[5:0]	6	00	V1_5START0[11:6]	
18E	[3:0]	4	00	V2SPTRFIRST0	V2 Sequence for Region #0 (First Lines)
18F	[0]	1	00	V2INVFIRST0	V2 Sequence Inversion for Region #0 (First Lines)
190	[3:0]	4	00	V2SPTRSECOND0	V2 Sequence for Region #0 (Second Lines)
191	[0]	1	00	V2INVSECOND0	V2 Sequence Inversion for Region #0 (Second Lines)
192	[5:0]	6	3D	V4_7START4[5:0]	V2 and V6 Sequence Start for Region #0
193	[5:0]	6	00	V2_6START0[11:6]	
194	[3:0]	4	01	V3SPTRFIRST0	V3 Sequence for Region #0 (First Lines)
195	[0]	1	00	V3INVFIRST0	V3 Sequence Inversion for Region #0 (First Lines)
196	[3:0]	4	00	V3SPTRSECOND0	V3 Sequence for Region #0 (Second Lines)
197	[0]	1	00	V3INVSECOND0	V3 Sequence Inversion for Region #0 (Second Lines)
198	[5:0]	6	34	V4_7START4[5:0]	V3 and V7 Sequence Start for Region #0
199	[5:0]	6	00	V3_7START0[11:6]	
19A	[3:0]	4	01	V4SPTRFIRST0	V4 Sequence for Region #0 (First Lines)
19B	[0]	1	00	V4INVFIRST0	V4 Sequence Inversion for Region #0 (First Lines)
19C	[3:0]	4	00	V4SPTRSECOND0	V4 Sequence for Region #0 (Second Lines)
19D	[0]	1	00	V4INVSECOND0	V4 Sequence Inversion for Region #0 (Second Lines)
19E	[5:0]	6	3D	V4_8START0[5:0]	V4 and V8 Sequence Start for Region #0
19F	[5:0]	6	00	V4_8START0[11:6]	
1A0	[5:0]	6	00	V1_4FREEZE0[5:0]	V1-V4 Freeze Start Position for Region #0
1A1	[5:0]	6	00	V1_4FREEZE0[11:6]	
1A2	[5:0]	6	00	V1_4RESUME0[5:0]	V1-V4 Resume Start Position for Region #0
1A3	[5:0]	6	00	V1_4RESUME0[11:6]	
1A4	[5:0]	6	00	V5_8FREEZE0[5:0]	V5-V8 Freeze Start Position for Region #0
1A5	[5:0]	6	00	V5_8FREEZE0[11:6]	
1A6	[5:0]	6	00	V5_8RESUME0[5:0]	V5-V8 Resume Start Position for Region #0
1A7	[5:0]	6	00	V5_8RESUME0[11:6]	
1A8	[0]	1	00	SWEEP1	V Sweep for Region #1
1A9	[0]	1	00	MULTI1	V Multiplier for Region #1
1AA	[5:0]	6	3F	HDLEN1[5:0]	Region #1 HD Line Length
1AB	[5:0]	6	3F	HDLEN1[11:6]	
1AC	[1:0]	2	00	HBLKSPTR1	HBLK Sequence for Region #1
1AD	[0]	1	00	VTPALT1	V Sequence Alternation for Region #1
1AE	[3:0]	4	00	V1SPTRFIRST1	V1 Sequence for Region #1 (First Lines)
1AF	[0]	1	00	V1INVFIRST1	V1 Sequence Inversion for Region #1 (First Lines)
1B0	[3:0]	4	00	V1SPTRSECOND1	V1 Sequence for Region #1 (Second Lines)
1B1	[0]	1	00	V1INVSECOND1	V1 Sequence Inversion for Region #1 (Second Lines)
1B2	[5:0]	6	00	V1_5START1[5:0]	V1 and V5 Sequence Start for Region #1
1B3	[5:0]	6	00	V1_5START1[11:6]	
1B4	[3:0]	4	00	V2SPTRFIRST1	V2 Sequence for Region #1 (First Lines)
1B5	[0]	1	00	V2INVFIRST1	V2 Sequence Inversion for Region #1 (First Lines)
1B6	[3:0]	4	00	V2SPTRSECOND1	V2 Sequence for Region #1 (Second Lines)
1B7	[0]	1	00	V2INVSECOND1	V2 Sequence Inversion for Region #1 (Second Lines)
1B8	[5:0]	6	00	V2_6START1[5:0]	V2 and V6 Sequence Start for Region #1
1B9	[5:0]	6	00	V2_6START1[11:6]	
1BA	[3:0]	4	00	V3SPTRFIRST1	V3 Sequence for Region #1 (First Lines)
1BB	[0]	1	00	V3INVFIRST1	V3 Sequence Inversion for Region #1 (First Lines)
1BC	[3:0]	4	00	V3SPTRSECOND1	V3 Sequence for Region #1 (Second Lines)
1BD	[0]	1	00	V3INVSECOND1	V3 Sequence Inversion for Region #1 (Second Lines)
1BE	[5:0]	6	00	V3_7START1[5:0]	V3 and V7 Sequence Start for Region #1

Table XXVIII. V1-V8 Register Map (continued)

Address	Content	Bit Width	Default Value	Register Name	Register Description
1BF	[5:0]	6	00	V3_7START1[11:6]	
1C0	[3:0]	4	00	V4SPTRFIRST1	V4 Sequence for Region #1 (First Lines)
1C1	[0]	1	00	V4INVFIRST1	V4 Sequence Inversion for Region #1 (First Lines)
1C2	[3:0]	4	00	V4SPTRSECOND1	V4 Sequence for Region #1 (Second Lines)
1C3	[0]	1	00	V4INVSECOND1	V4 Sequence Inversion for Region #1 (Second Lines)
1C4	[5:0]	6	00	V4_8START1[5:0]	V4 and V8 Sequence Start for Region #1
1C5	[5:0]	6	00	V4_8START1[11:6]	
1C6	[5:0]	6	00	V1_4FREEZE1[5:0]	V1-V4 Freeze Start Position for Region #1
1C7	[5:0]	6	00	V1_4FREEZE1[11:6]	
1C8	[5:0]	6	00	V1_4RESUME1[5:0]	V1-V4 Resume Start Position for Region #1
1C9	[5:0]	6	00	V1_4RESUME1[11:6]	
1CA	[5:0]	6	00	V5_8FREEZE1[5:0]	V5-V8 Freeze Start Position for Region #1
1CB	[5:0]	6	00	V5_8FREEZE1[11:6]	
1CC	[5:0]	6	00	V5_8RESUME1[5:0]	V5-V8 Resume Start Position for Region #1
1CD	[5:0]	6	00	V5_8RESUME1[11:6]	
1CE	[0]	1	00	SWEEP2	V Sweep for Region #2
1CF	[0]	1	00	MULTI2	V Multiplier for Region #2
1D0	[5:0]	6	3F	HDLEN2[5:0]	Region #2 HD Line Length
1D1	[5:0]	6	3F	HDLEN2[11:6]	
1D2	[1:0]	2	00	HBLKSPTR2	HBLK Sequence for Region #2
1D3	[0]	1	00	VTPALT2	V Sequence Alternation for Region #2
1D4	[3:0]	4	00	V1SPTRFIRST2	V1 Sequence for Region #2 (First Lines)
1D5	[0]	1	00	V1INVFIRST2	V1 Sequence Inversion for Region #2 (First Lines)
1D6	[3:0]	4	00	V1SPTRSECOND2	V1 Sequence for Region #2 (Second Lines)
1D7	[0]	1	00	V1INVSECOND2	V1 Sequence Inversion for Region #2 (Second Lines)
1D8	[5:0]	6	00	V1_5START2[5:0]	V1 and V5 Sequence Start for Region #2
1D9	[5:0]	6	00	V1_5START2[11:6]	
1DA	[3:0]	4	00	V2SPTRFIRST2	V2 Sequence for Region #2 (First Lines)
1DB	[0]	1	00	V2INVFIRST2	V2 Sequence Inversion for Region #2 (First Lines)
1DC	[3:0]	4	00	V2SPTRSECOND2	V2 Sequence for Region #2 (Second Lines)
1DD	[0]	1	00	V2INVSECOND2	V2 Sequence Inversion for Region #2 (Second Lines)
1DE	[5:0]	6	00	V2_6START2[5:0]	V2 and V6 Sequence Start for Region #2
1DF	[5:0]	6	00	V2_6START2[11:6]	
1E0	[3:0]	4	00	V3SPTRFIRST2	V3 Sequence for Region #2 (First Lines)
1E1	[0]	1	00	V3INVFIRST2	V3 Sequence Inversion for Region #2 (First Lines)
1E2	[3:0]	4	00	V3SPTRSECOND2	V3 Sequence for Region #2 (Second Lines)
1E3	[0]	1	00	V3INVSECOND2	V3 Sequence Inversion for Region #2 (Second Lines)
1E4	[5:0]	6	00	V3_7START2[5:0]	V3 and V7 Sequence Start for Region #2
1E5	[5:0]	6	00	V3_7START2[11:6]	
1E6	[3:0]	4	00	V4SPTRFIRST2	V4 Sequence for Region #2 (First Lines)
1E7	[0]	1	00	V4INVFIRST2	V4 Sequence Inversion for Region #2 (First Lines)
1E8	[3:0]	4	00	V4SPTRSECOND2	V4 Sequence for Region #2 (Second Lines)
1E9	[0]	1	00	V4INVSECOND2	V4 Sequence Inversion for Region #2 (Second Lines)
1EA	[5:0]	6	00	V4_8START2[5:0]	V4 and V8 Sequence Start for Region #2
1EB	[5:0]	6	00	V4_8START2[11:6]	
1EC	[5:0]	6	00	V1_4FREEZE2[5:0]	V1-V4 Freeze Start Position for Region #2
1ED	[5:0]	6	00	V1_4FREEZE2[11:6]	
1EE	[5:0]	6	00	V1_4RESUME2[5:0]	V1-V4 Resume Start Position for Region #2
1EF	[5:0]	6	00	V1_4RESUME2[11:6]	
1F0	[5:0]	6	00	V5_8FREEZE2[5:0]	V5-V8 Freeze Start Position for Region #2
1F1	[5:0]	6	00	V5_8FREEZE2[11:6]	
1F2	[5:0]	6	00	V5_8RESUME2[5:0]	V5-V8 Resume Start Position for Region #2
1F3	[5:0]	6	00	V5_8RESUME2[11:6]	
1F4	[0]	1	00	SWEEP3	V Sweep for Region #3
1F5	[0]	1	00	MULTI3	V Multiplier for Region #3

Table XXVIII. V1-V8 Register Map (continued)

Address	Content	Bit Width	Default Value	Register Name	Register Description
1F6	[5:0]	6	3F	HDLEN3[5:0]	Region #3 HD Line Length
1F7	[5:0]	6	3F	HDLEN3[11:6]	
1F8	[1:0]	2	00	HBLKSPTR3	HBLK Sequence for Region #3
1F9	[0]	1	00	VTPALT3	VTP Sequence Alternation for Region #3
1FA	[3:0]	4	00	V1SPTRFIRST3	V1 Sequence for Region #3 (First Lines)
1FB	[0]	1	00	V1INVFIRST3	V1 Sequence Inversion for Region #3 (First Lines)
1FC	[3:0]	4	00	V1SPTRSECOND3	V1 Sequence for Region #3 (Second Lines)
1FD	[0]	1	00	V1INVSECOND3	V1 Sequence Inversion for Region #3 (Second Lines)
1FE	[5:0]	6	00	V1_5START3[5:0]	V1 and V5 Sequence Start for Region #3
1FF	[5:0]	6	00	V1_5START3[11:6]	
200	[3:0]	4	00	V2SPTRFIRST3	V2 Sequence for Region #3 (First Lines)
201	[0]	1	00	V2INVFIRST3	V2 Sequence Inversion for Region #3 (First Lines)
202	[3:0]	4	00	V2SPTRSECOND3	V2 Sequence for Region #3 (Second Lines)
203	[0]	1	00	V2INVSECOND3	V2 Sequence Inversion for Region #3 (Second Lines)
204	[5:0]	6	00	V2_6START3[5:0]	V2 and V6 Sequence Start for Region #3
205	[5:0]	6	00	V2_6START3[11:6]	
206	[3:0]	4	00	V3SPTRFIRST3	V3 Sequence for Region #3 (First Lines)
207	[0]	1	00	V3INVFIRST3	V3 Sequence Inversion for Region #3 (First Lines)
208	[3:0]	4	00	V3SPTRSECOND3	V3 Sequence for Region #3 (Second Lines)
209	[0]	1	00	V3INVSECOND3	V3 Sequence Inversion for Region #3 (Second Lines)
20A	[5:0]	6	00	V3_7START3[5:0]	V3 and V7 Sequence Start for Region #3
20B	[5:0]	6	00	V3_7START3[11:6]	
20C	[3:0]	4	00	V4SPTRFIRST3	V4 Sequence for Region #3 (First Lines)
20D	[0]	1	00	V4INVFIRST3	V4 Sequence Inversion for Region #3 (First Lines)
20E	[3:0]	4	00	V4SPTRSECOND3	V4 Sequence for Region #3 (Second Lines)
20F	[0]	1	00	V4INVSECOND3	V4 Sequence Inversion for Region #3 (Second Lines)
210	[5:0]	6	00	V4_8START3[5:0]	V4 and V8 Sequence Start for Region #3
211	[5:0]	6	00	V4_8START3[11:6]	
212	[5:0]	6	00	V1_4FREEZE3[5:0]	V1-V4 Freeze Start Position for Region #3
213	[5:0]	6	00	V1_4FREEZE3[11:6]	
214	[5:0]	6	00	V1_4RESUME3[5:0]	V1-V4 Resume Start Position for Region #3
215	[5:0]	6	00	V1_4RESUME3[11:6]	
216	[5:0]	6	00	V5_8FREEZE3[5:0]	V5-V8 Freeze Start Position for Region #3
217	[5:0]	6	00	V5_8FREEZE3[11:6]	
218	[5:0]	6	00	V5_8RESUME3[5:0]	V5-V8 Resume Start Position for Region #3
219	[5:0]	6	00	V5_8RESUME3[11:6]	
21A	[0]	1	00	SWEEP4	V Sweep for Region #4
21B	[0]	1	00	MULTI4	V Multiplier for Region #4
21C	[5:0]	6	3F	HDLEN4[5:0]	Region #4 HD Line Length
21D	[5:0]	6	3F	HDLEN4[11:6]	
21E	[1:0]	2	00	HBLKSPTR4	HBLK Sequence for Region #4
21F	[0]	1	00	VTPALT4	VTP Sequence Alternation for Region #4
220	[3:0]	4	00	V1SPTRFIRST4	V1 Sequence for Region #4 (First Lines)
221	[0]	1	00	V1INVFIRST4	V1 Sequence Inversion for Region #4 (First Lines)
222	[3:0]	4	00	V1SPTRSECOND4	V1 Sequence for Region #4 (Second Lines)
223	[0]	1	00	V1INVSECOND4	V1 Sequence Inversion for Region #4 (Second Lines)
224	[5:0]	6	00	V1_5START4[5:0]	V1 and V5 Sequence Start for Region #4
225	[5:0]	6	00	V1_5START4[11:6]	
226	[3:0]	4	00	V2SPTRFIRST4	V2 Sequence for Region #4 (First Lines)
227	[0]	1	00	V2INVFIRST4	V2 Sequence Inversion for Region #4 (First Lines)
228	[3:0]	4	00	V2SPTRSECOND4	V2 Sequence for Region #4 (Second Lines)
229	[0]	1	00	V2INVSECOND4	V2 Sequence Inversion for Region #4 (Second Lines)
22A	[5:0]	6	00	V2_6START4[5:0]	V2 and V6 Sequence Start for Region #4
22B	[5:0]	6	00	V2_6START4[11:6]	
22C	[3:0]	4	00	V4SPTRFIRST4	V4 Sequence for Region #4 (First Lines)

Table XXVIII. V1-V8 Register Map (continued)

Address	Content	Bit Width	Default Value	Register Name	Register Description
22D	[0]	1	00	V4INVFIRST4	V4 Sequence Inversion for Region #4 (First Lines)
22E	[3:0]	4	00	V4SPTRSECOND4	V4 Sequence for Region #4 (Second Lines)
22F	[0]	1	00	V4INVSECOND4	V4 Sequence Inversion for Region #4 (Second Lines)
230	[5:0]	6	00	V4_7START4[5:0]	V4 and V7 Sequence Start for Region #4
231	[5:0]	6	00	V4_7START4[11:6]	
232	[3:0]	4	00	V4SPTRFIRST4	V4 Sequence for Region #4 (First Lines)
233	[0]	1	00	V4INVFIRST4	V4 Sequence Inversion for Region #4 (First Lines)
234	[3:0]	4	00	V4SPTRSECOND4	V4 Sequence for Region #4 (Second Lines)
235	[0]	1	00	V4INVSECOND4	V4 Sequence Inversion for Region #4 (Second Lines)
236	[5:0]	6	00	V4_8START4[5:0]	V4 and V8 Sequence Start for Region #4
237	[5:0]	6	00	V4_8START4[11:6]	
238	[5:0]	6	00	V1_4FREEZE4[5:0]	V1-V4 Freeze Start Position for Region #4
239	[5:0]	6	00	V1_4FREEZE4[11:6]	
23A	[5:0]	6	00	V1_4RESUME4[5:0]	V1-V4 Resume Start Position for Region #4
23B	[5:0]	6	00	V1_4RESUME4[11:6]	
23C	[5:0]	6	00	V5_8FREEZE4[5:0]	V5-V8 Freeze Start Position for Region #4
23D	[5:0]	6	00	V5_8FREEZE4[11:6]	
23E	[5:0]	6	00	V5_8RESUME4[5:0]	V5-V8 Resume Start Position for Region #4
23F	[5:0]	6	00	VTP5_8RESUME4[11:6]	
240	[0]	1	01	VTP_SGLINEMODE	VTP Second Sequence Output Enable during SGLINE
241	[3:0]	4	02	V1SPTR_SGLINE	V1 Second Sequence
242	[0]	1	00	V1INV_SGLINE	V1 Second Sequence Inversion
243	[5:0]	6	10	V1START_SGLINE[5:0]	V1 Start Position of Second V Pulse
244	[5:0]	6	10	V1START_SGLINE[11:6]	
245	[3:0]	4	03	V2SPTR_SGLINE	V2 Second Sequence
246	[0]	1	00	V2INV_SGLINE	V2 Second Sequence Inversion
247	[5:0]	6	2A	V2START_SGLINE[5:0]	V2 Start Position of Second V Pulse
248	[5:0]	6	11	V2START_SGLINE[11:6]	
249	[3:0]	4	04	V3SPTR_SGLINE	V3 Second Sequence
24A	[0]	1	00	V3INV_SGLINE	V3 Second Sequence Inversion
24B	[5:0]	6	32	V3START_SGLINE[5:0]	V3 Start Position of Second VTP Pulse
24C	[5:0]	6	0F	V3START_SGLINE[11:6]	
24D	[3:0]	4	05	V4SPTR_SGLINE	V4 Second Sequence
24E	[0]	1	00	V4INV_SGLINE	V4 Second Sequence Inversion
24F	[5:0]	6	2E	V4START_SGLINE[5:0]	V4 Start Position of Second VTP Pulse
250	[5:0]	6	10	V4START_SGLINE[11:6]	

Table XXIX. VSG1-VSG8 Register Map

Address	Content	Bit Width	Default Value	Register Name	Register Description
251	[0]	1	01	SGPOL0	Sequence #0: Start Polarity
252	[5:0]	6	22	SGTOG1_0[5:0]	Sequence #0: Toggle Position 1
253	[5:0]	6	13	SGTOG1_0[11:6]	
254	[5:0]	6	1E	SGTOG2_0[5:0]	Sequence #0: Toggle Position 2
255	[5:0]	6	14	SGTOG2_0[11:6]	
256	[0]	1	01	SGPOL1	Sequence #1: Start Polarity
257	[5:0]	6	0C	SGTOG1_1[5:0]	Sequence #1: Toggle Position 1
258	[5:0]	6	11	SGTOG1_1[11:6]	
259	[5:0]	6	08	SGTOG2_1[5:0]	Sequence #1: Toggle Position 2
25A	[5:0]	6	12	SGTOG2_1[11:6]	
25B	[0]	1	01	SGPOL2	Sequence #2: Start Polarity
25C	[5:0]	6	3F	SGTOG1_2[5:0]	Sequence #2: Toggle Position 1
25D	[5:0]	6	3F	SGTOG1_2[11:6]	
25E	[5:0]	6	3F	SGTOG2_2[5:0]	Sequence #2: Toggle Position 2
25F	[5:0]	6	3F	SGTOG2_2[11:6]	
260	[0]	1	01	SGPOL3	Sequence #3: Start Polarity
261	[5:0]	6	3F	SGTOG1_3[5:0]	Sequence #3: Toggle Position 1
262	[5:0]	6	3F	SGTOG1_3[11:6]	
263	[5:0]	6	3F	SGTOG2_3[5:0]	Sequence #3: Toggle Position 2
264	[5:0]	6	3F	SGTOG2_3[11:6]	
265	[5:0]	6	00	SGACTLINE[5:0]	VSG Active Line
266	[4:0]	6	00	SGACTLINE[11:6]	
267	[1:0]	2	00	SGSEL1	VSG1 Sequence Selector
268	[1:0]	2	00	SGSEL2	VSG2 Sequence Selector
269	[1:0]	2	00	SGSEL3	VSG3 Sequence Selector
26A	[1:0]	2	00	SGSEL4	VSG4 Sequence Selector
26B	[1:0]	2	01	SGSEL5	VSG5 Sequence Selector
26C	[1:0]	2	01	SGSEL6	VSG6 Sequence Selector
26D	[1:0]	2	01	SGSEL7	VSG7 Sequence Selector
26E	[1:0]	2	01	SGSEL8	VSG8 Sequence Selector
26F	[5:0]	6	00	SGMASK[5:0]	VSG Masking (0 = Output, 1 = Mask)
270	[1:0]	2	00	SGMASK[7:6]	

Table XXX. SUBCK, VSUB, MSHUT Register Map

Address	Content	Bit Width	Default Value	Register Name	Register Description
271	[0]	1	01	SUBCKPOL	SUBCK Start Polarity
272	[5:0]	6	0B	SUBCK1TOG1[5:0]	First SUBCK Toggle Position 1
273	[5:0]	6	01	SUBCK1TOG1[11:6]	
274	[5:0]	6	05	SUBCK1TOG2[5:0]	First SUBCK Toggle Position 2
275	[5:0]	6	02	SUBCK1TOG2[11:6]	
276	[5:0]	6	3F	SUBCK2TOG1[5:0]	Second SUBCK Toggle Position 1
277	[5:0]	6	3F	SUBCK2TOG1[11:6]	
278	[5:0]	6	3F	SUBCK2TOG2[5:0]	Second SUBCK Toggle Position 2
279	[5:0]	6	3F	SUBCK2TOG2[11:6]	
27A	[5:0]	6	3F	SUBCKNUM[5:0]	Number of SUBCKs per Field
27B	[5:0]	6	00	SUBCKNUM[11:6]	
27C	[5:0]	6	00	SUBCKSUPPRESS	Number of SUCKs to Suppress after VSG Line
27D	[5:0]	6	00	EXPOSURE[5:0]	Number of Fields to Suppress SUBCK/VSG (Exposure Time)
27E	[5:0]	6	00	EXPOSURE[11:6]	
27F	[0]	1	00	VDHDOFF	Disable VD and HD during Exposure
280	[2:0]	3	00	TRIGGER	VSUB (TRIGGER[0]), MSHUT (TRIGGER[1]), STROBE (TRIGGER[2]) Trigger
281	[2:0]	3	02	READOUT	SUBCK Suppression after Exposure during Readout
282	[0]	1	00	VSUBMODE	VSUB Readout Mode

Table XXX. SUBCK, VSUB, MSHUT Register Map (continued)

Address	Content	Bit Width	Default Value	Register Name	Register Description
283	[0]	1	00	VSUBKEEPON	VSUB Off Mode (0 = Turn Off after Readout or Next VD, 1 = Keep Active beyond Readout)
284	[0]	1	01	VSUBPOL	VSUB Active Polarity
285	[5:0]	6	00	VSUBON[5:0]	VSUB On Position
286	[5:0]	6	00	VSUBON[11:6]	
287	[0]	1	00	MSHUTON	MSHUT Enable (VD Aligned)
288	[0]	1	01	MSHUTPOL	MSHUT Active Polarity
289	[5:0]	6	00	MSHUTONPOS_LN[5:0]	MSHUT On Line Position (In Terms of HDs from VD Update)
28A	[5:0]	6	00	MSHUTONPOS_LN[11:6]	
28B	[5:0]	6	00	MSHUTONPOS_PIX[5:0]	MSHUT On Pixel Position (In Terms of Pixels from HD On Position)
28C	[5:0]	6	00	MSHUTONPOS_PIX[11:6]	
28D	[5:0]	6	00	MSHUTOFF_FD[5:0]	MSHUT Field Off Position (In Terms of VDs from Field Containing Last SUBCK)
28E	[5:0]	6	00	MSHUTOFF_FD[11:6]	
28F	[5:0]	6	00	MSHUTOFF_LN[5:0]	MSHUT Line Off Position (In Terms of HDs from VD Aligned Off Position)
290	[5:0]	6	00	MSHUTOFF_LN[11:6]	
291	[5:0]	6	00	MSHUTOFF_PX[5:0]	MSHUT Pixel Off Position (In Terms of Pixels from HD Aligned Off Position)
292	[5:0]	6	00	MSHUTOFF_PX[11:6]	
293	[0]	1	01	STROBPOL	STROBE Active Polarity
294	[5:0]	6	00	STROBON_FD[5:0]	STROBE Field On Position (In Terms of VDs from Field Containing Last SUBCK)
295	[5:0]	6	00	STROBON_FD[11:6]	
296	[5:0]	6	00	STROBON_LN[5:0]	STROBE Line On Position (In Terms of HDs from VD Aligned On Position)
297	[5:0]	6	00	STROBON_LN[11:6]	
298	[5:0]	6	00	STROBON_PX[5:0]	STROBE Pixel On Position (In Terms of Pixels from HD Aligned On Position)
299	[5:0]	6	00	STROBON_PX[11:6]	
29A	[5:0]	6	00	STROBOFF_FD[5:0]	STROBE Field Off Position (In Terms of VDs from Field Containing Last SUBCK)
29B	[5:0]	6	00	STROBOFF_FD[11:6]	
29C	[5:0]	6	00	STROBOFF_LN[5:0]	STROBE Line Off Position (In Terms of HDs from VD Aligned Off Position)
29D	[5:0]	6	00	STROBOFF_LN[11:6]	
29E	[5:0]	6	00	STROBOFF_PX[5:0]	STROBE Pixel Off Position (In Terms of Pixels from HD Aligned Off Position)
29F	[5:0]	6	00	STROBOFF_PX[11:6]	

AD9891/AD9895

Table XXXI. AFE Register Breakdown

Content	Bit Width	Default Value	Register Name	Register Description
OPRMODE		8'h0		Serial Address: 10'h0{OPRMODE[5:0]}, 10'h1{OPRMODE[7:6]}
[7:0]				
[1:0]	2'h0 2'h1 2'h2 2'h3		POWERDOWN[1:0]	Normal Operation Standby1 (See Standby Modes Table) Standby2 (See Standby Modes Table) Standby3 (See Standby Modes Table)
[2]			DISBLACK	Disable Black Loop Clamping (HIGH Active)
[3]			Test Mode	Test Mode—Should Be Set LOW
[4]			Test Mode	Test Mode—Should Be Set HIGH
[5]			Test Mode	Test Mode—Should Be Set LOW
[6]			Test Mode	Test Mode—Should Be Set LOW
[7]			Test Mode	Test Mode—Should Be Set LOW
CTLMODE		6'h0		Serial Address: 10'h6{CLTMODE[5:0]}
[5:0]				
[2:0]	3'h0 3'h1 3'h2 3'h3 3'h4 3'h5 3'h6 3'h7		CTLMODE[2:0]	OFF Mosaic Separate VD Selected/Mosaic Interlaced Mosaic Repeat 3-Color 3-Color II 4-Color 4-Color II
[3]			ENABLEPXGA	Enable PxGA (HIGH Active)
[4]	1'h0 1'h1		OUTPUTLAT	Latch Output Data on Selected DOUT Edge Leave Output Latch Transparent
[5]	1'h0 1'h1		TRISTATEOUT	ADC Outputs Are Driven ADC Outputs Are Three-Stated

OUTLINE DIMENSIONS

64-Lead Plastic Ball Grid Array [CSPBGA]
(BC-64)

Dimensions shown in millimeters

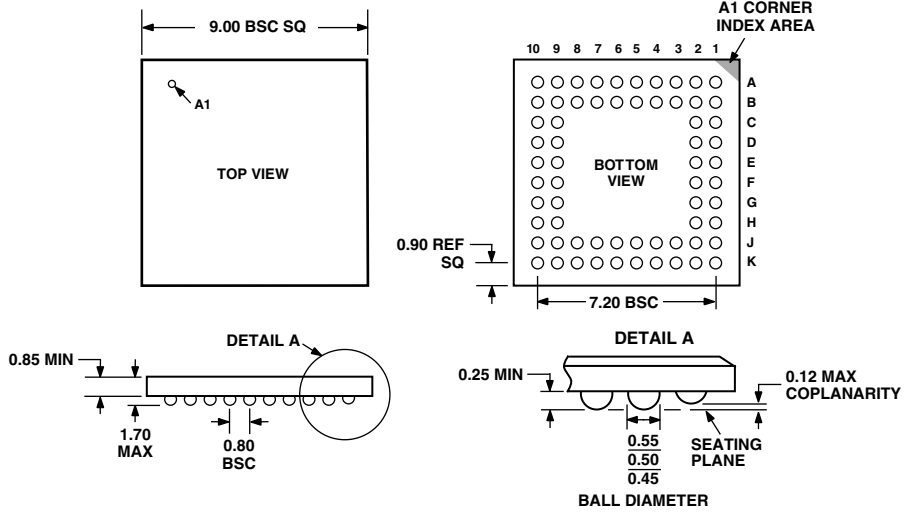

COMPLIANT TO JEDEC STANDARDS MO-205-AB

Revision History

Location	Page
8/02—Data Sheet changed from REV. 0 to REV. A.	
Added AD9895 part	Universal

Looking for pricing, stock, or lifecycle information?

Click below to explore more details on WIN SOURCE:

 [View AD9895KBCZRL on WIN SOURCE](#)

 [Analog Devices Inc. Information](#)

Optimize Your Supply Chain with WIN SOURCE Solutions

-  Global Sourcing Solution
-  Obsolete Management
-  Cost Control Management
-  Shortage Management
-  Alternative Solution
-  Excess Inventory Management