



**THE DATASHEET OF
RCLAMP0534N.TCT**



PROTECTION PRODUCTS - RailClamp®

Description

RailClamp® TVS diodes are specifically designed to protect sensitive components which are connected to high-speed data and transmission lines from overvoltage caused by ESD (electrostatic discharge), CDE (cable discharge events), and EFT (electrical fast transients).

The unique design incorporates surge rated, low capacitance steering diodes and a TVS diode in a single package. This allows the device to absorb large amounts of energy while protecting downstream components from harmful transient events.

The RClamp®0534N is in a 10-pin SLP3020N10 package. It measures 3.0 x 2.0 x 0.60mm. The leads are finished with lead-free NiPdAu. The combination of small size, low capacitance, and high surge capability makes them ideal for use in applications such as 10/100 Ethernet, USB 2.0, and video interfaces.

Features

- ◆ ESD protection for high-speed data lines to **IEC 61000-4-2 (ESD) ±30kV (air), ±30kV (contact)**
- ◆ **IEC 61000-4-4 (EFT) 40A (5/50ns)**
- ◆ **IEC 61000-4-5 (Lightning) 25A (8/20µs)**
- ◆ Array of surge rated diodes with internal TVS Diode
- ◆ Small package saves board space
- ◆ Protects four I/O lines and Voltage Bus
- ◆ Low capacitance: 5pF (VR=0V)
- ◆ Low clamping voltage
- ◆ Low operating voltage: 5.0V
- ◆ Solid-state silicon-avalanche technology

Mechanical Characteristics

- ◆ SLP3020N10 10L package
- ◆ Pb-Free, Halogen Free, RoHS/WEEE Compliant
- ◆ Nominal Dimensions: 3.0 x 2.0 x 0.60 mm
- ◆ Lead Finish: NiPdAu
- ◆ Molding compound flammability rating: UL 94V-0
- ◆ Marking : Marking code + Date code
- ◆ Packaging : Tape and Reel

Applications

- ◆ USB 2.0 Power and Data Line Protection
- ◆ Video Graphics Cards
- ◆ Monitors and Flat Panel Displays
- ◆ Digital Video Interface (DVI)
- ◆ Notebook Computers
- ◆ Networking Equipment

Circuit Diagram

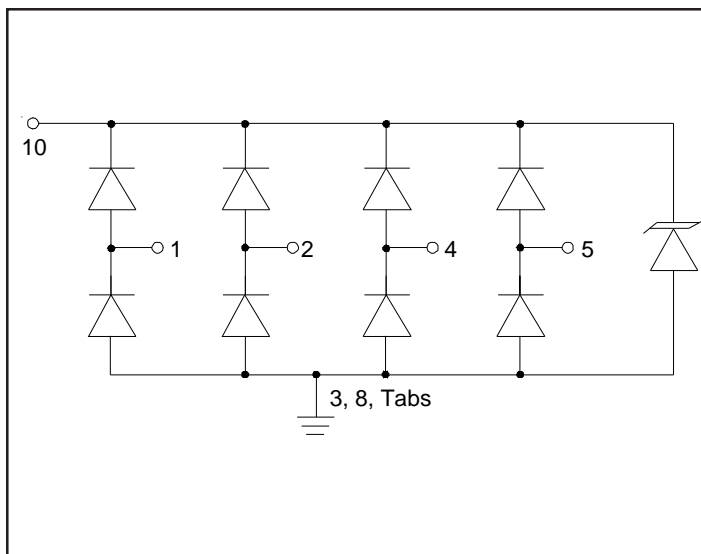

Circuit Diagram

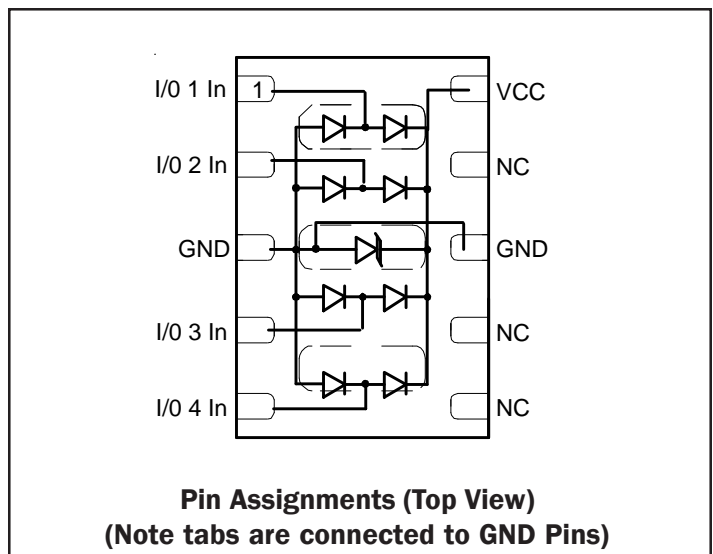

PROTECTION PRODUCTS
Absolute Maximum Rating

Rating	Symbol	Value	Units
Peak Pulse Power (tp = 8/20μs)	P_{pk}	500	Watts
Peak Pulse Current (tp = 8/20μs)	I_{pp}	25	A
ESD per IEC 61000-4-2 (Air) ESD per IEC 61000-4-2 (Contact)	VESD	+/- 30 +/- 30	kV
Operating Temperature	T_J	-55 to +125	°C
Storage Temperature	T_{STG}	-55 to +150	°C

Electrical Characteristics (T=25°C)

Parameter	Symbol	Conditions	Minimum	Typical	Maximum	Units
Reverse Stand-Off Voltage	V_{RWM}				5	V
Reverse Breakdown Voltage	V_{BR}	$I_t = 1mA$	6			V
Reverse Leakage Current	I_R	$V_{RWM} = 5V, T=25^\circ C$			0.5	μA
Clamping Voltage	V_C	$I_{pp} = 1A, tp = 8/20\mu s$ Any I/O to GND			10	V
Clamping Voltage	V_C	$I_{pp} = 10A, tp = 8/20\mu s$ Any I/O to GND			12	V
Clamping Voltage	V_C	$I_{pp} = 25A, tp = 8/20\mu s$ Any I/O to GND			15	V
Junction Capacitance	C_j	Any I/O to GND $V_R = 0V, f = 1MHz$		3.5	5	pF
		I/O to I/O $V_R = 0V, f = 1MHz$		1.5	3	pF

PROTECTION PRODUCTS

Typical Characteristics

Non-Repetitive Peak Pulse Power vs. Pulse Time

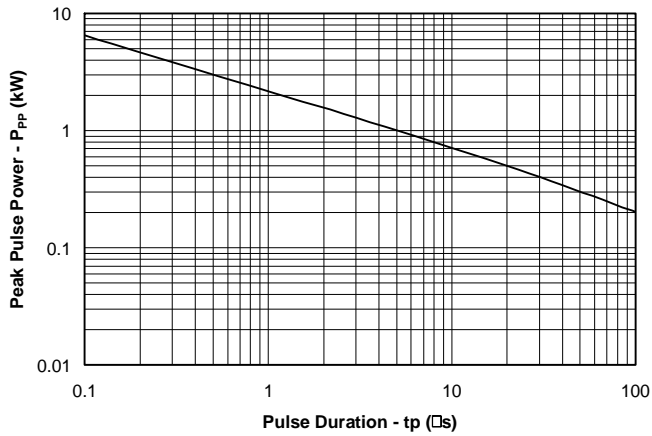

Power Derating Curve

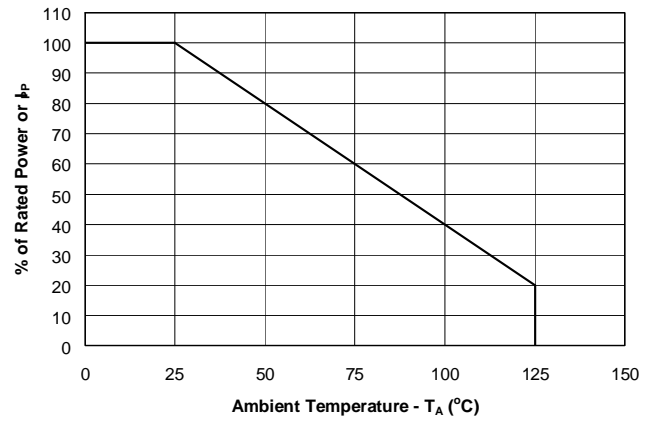

Surge Current Output Waveform ($t_p = 8/20\mu s$)

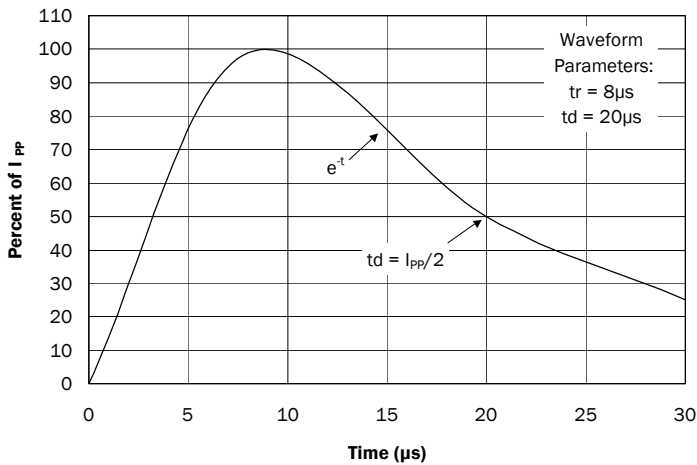

Clamping Voltage vs. Peak Pulse Current Any I/O to GND ($t_p = 8/20\mu s$)

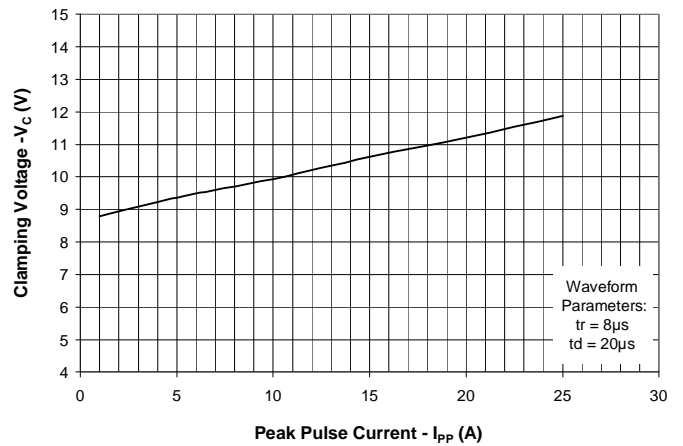

Forward Voltage vs. Forward Current

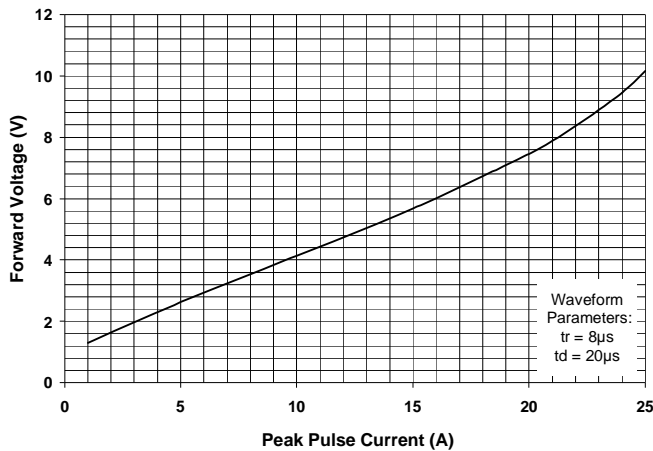

Normalized Capacitance vs. Reverse Voltage

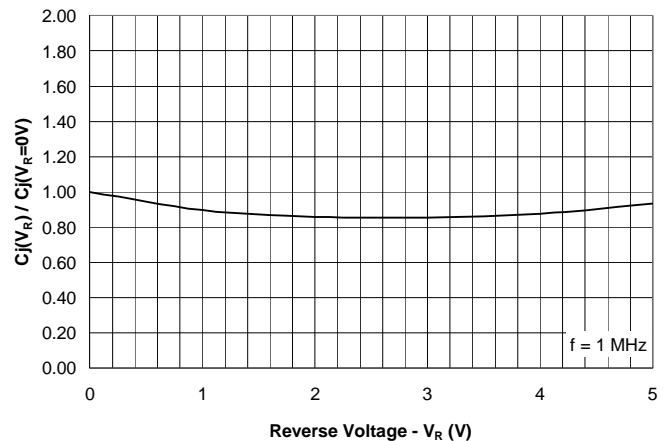

PROTECTION PRODUCTS

Typical Characteristics

Insertion Loss S21 - Any I/O to GND

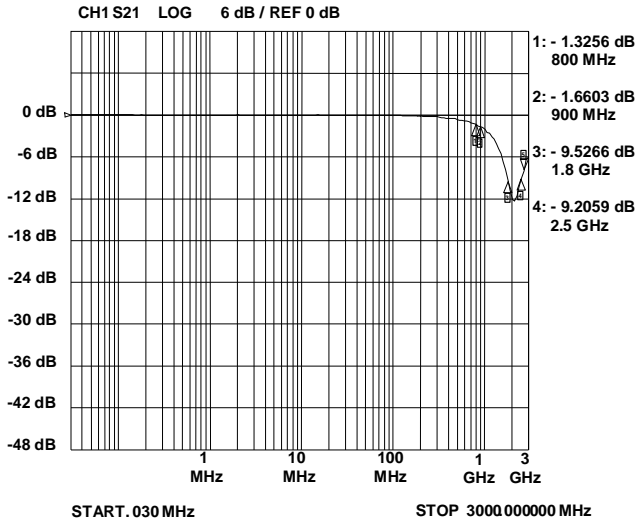

Insertion Loss S21 - I/O to I/O

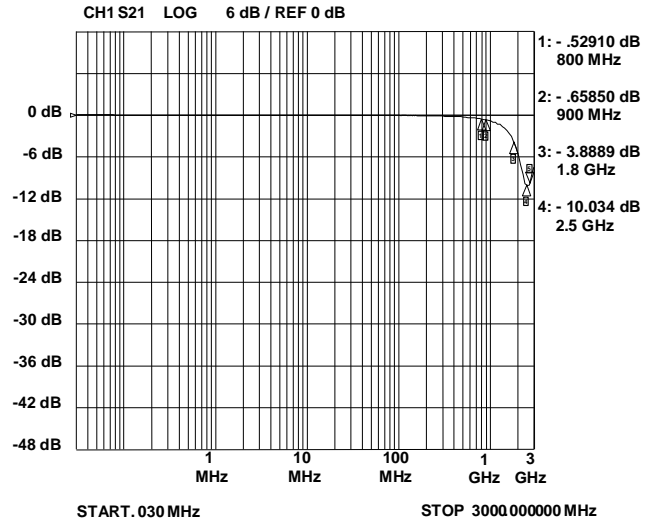

ESD Clamping - Between any I/O and GND (+8kV Contact per IEC 61000-4-2)

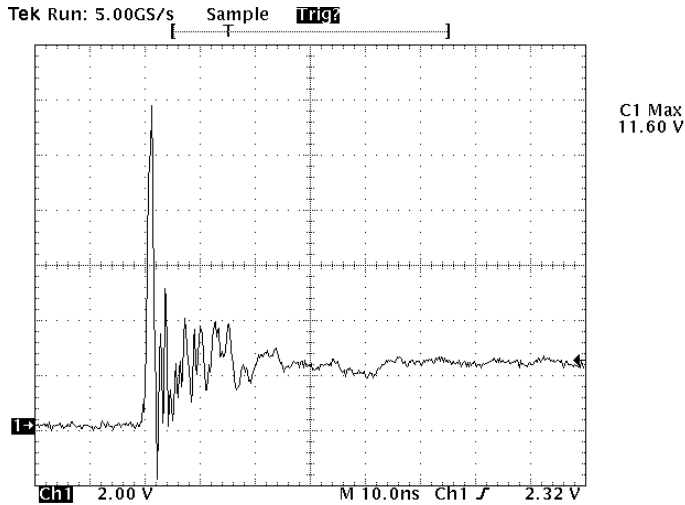

ESD Clamping - Between any I/O and GND (-8kV Contact per IEC 61000-4-2)

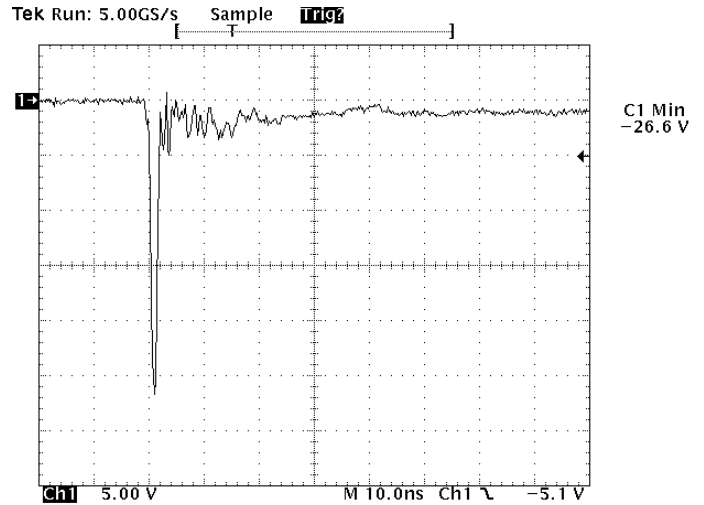

Note: Data is taken with a 10x attenuator

Note: Data is taken with a 10x attenuator

PROTECTION PRODUCTS

Applications Information

Device Connection Options for Protection of Four High-Speed Data Lines

The RClamp0534N is designed to protect four data lines from transient over-voltages by clamping them to a fixed reference. When the voltage on the protected line exceeds the reference voltage (plus diode V_f) the steering diodes are forward biased, conducting the transient current away from the sensitive circuitry. Data lines are connected at pins 1, 2, 4 and 5. The package is designed for easy trace routing. Pins 3 and 8 are internally connected to the center tabs and should be connected directly to a ground plane on the board for best results. The path length is kept as short as possible to minimize parasitic inductance. The positive reference (REF2) is connected at pin 9. The options for connecting the positive reference are as follows:

1. To protect data lines and the power line, connect pin 10 directly to the positive supply rail (V_{CC}). In this configuration the data lines are referenced to the supply voltage. The internal TVS diode prevents over-voltage on the supply rail.
2. The RClamp0534N can be isolated from the power supply by adding a series resistor between pin 10 and V_{CC} . A value of $100k\Omega$ is recommended. The internal TVS and steering diodes remain biased, providing the advantage of lower capacitance.
3. In applications where no positive supply reference is available, or complete supply isolation is desired, the internal TVS may be used as the reference. In this case, pin 10 is not connected. The steering diodes will begin to conduct when the voltage on the protected line exceeds the working voltage of the TVS (plus one diode drop).

Figure 1- Pin Configuration (Top View)

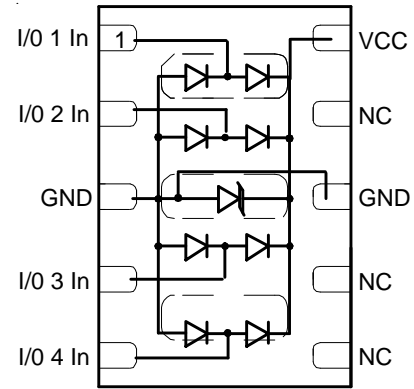
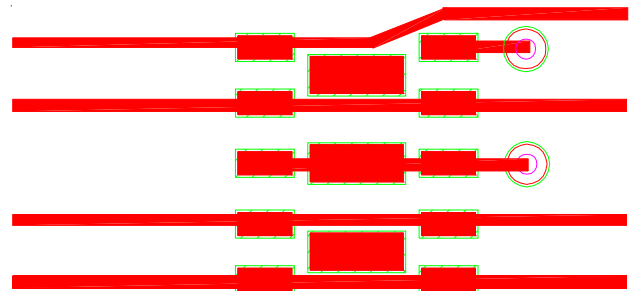
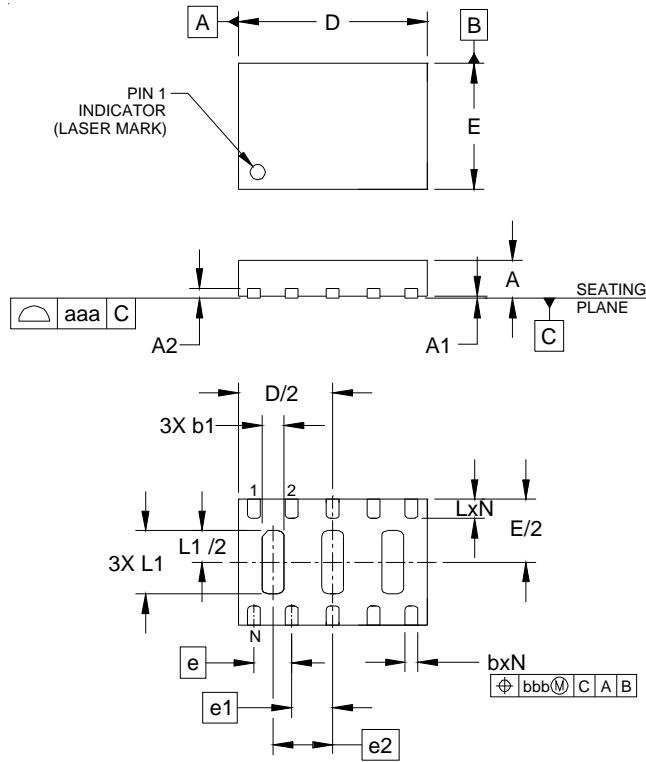

Figure 2 - Layout Example



PROTECTION PRODUCTS

Outline Drawing - SLP3020N10



DIM	MILLIMETERS		
	MIN	NOM	MAX
A	0.50	0.60	0.65
A1	0.00	0.03	0.05
A2		(0.15)	
b	0.15	0.20	0.25
b1	0.25	0.35	0.45
D	2.90	3.00	3.10
E	1.90	2.00	2.10
e	0.60 BSC		
e1	0.65 BSC		
e2	0.95 BSC		
L	0.25	0.30	0.35
L1	0.95	1.00	1.05
N	10		
aaa	0.08		
bbb	0.10		

NOTES:
1. CONTROLLING DIMENSIONS ARE IN MILLIMETERS (ANGLES IN DEGREES).

Land Pattern - SLP3020N10

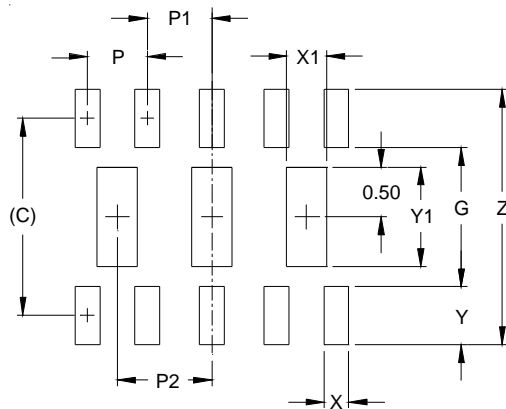

DIM	MILLIMETERS
	C
G	1.40
P	0.60
P1	0.65
P2	0.95
X	0.25
X1	0.40
Y	0.58
Y1	1.00
Z	2.56

NOTES:
1. CONTROLLING DIMENSIONS ARE IN MILLIMETERS (ANGLES IN DEGREES).
2. THIS LAND PATTERN IS FOR REFERENCE PURPOSES ONLY. CONSULT YOUR MANUFACTURING GROUP TO ENSURE YOUR COMPANY'S MANUFACTURING GUIDELINES ARE MET.

PROTECTION PRODUCTS

Marking

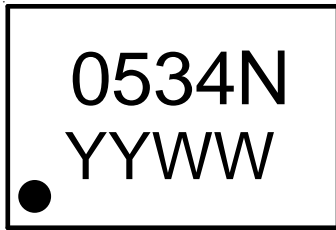

1

Ordering Information

Part Number	Working Voltage	Qty per Reel	Reel Size
RClamp0534N.TCT	5 Volts	3,000	7 Inch

RailClamp and RClamp are trademarks of Semtech Corporation

YYWW = Date Code

Tape and Reel Specification

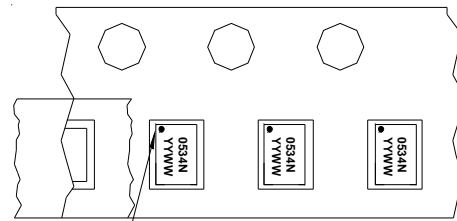
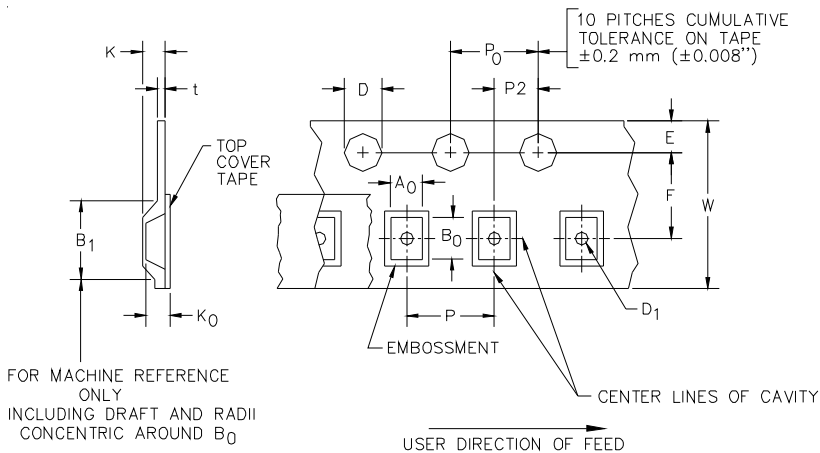

Pin 1 Location (Towards Sprocket Holes)

→
User Direction of feed

Device Orientation in Tape

A0	B0	K0
2.24 +/-0.05 mm	3.23 +/-0.05 mm	0.93 +/-0.05 mm



Tape Width	B, (Max)	D	D1	E	F	K (MAX)	P	P0	P2	T(MAX)	W
8 mm	4.2 mm	1.5 + 0.1 mm - 0.0 mm)	0.5 mm ±0.05	1.750±.10 mm	3.5±0.05 mm	2.4 mm	4.0±0.1 mm	4.0±0.1 mm	2.0±0.05 mm	0.4 mm	8.0 mm + 0.3 mm - 0.1 mm

Contact Information

Semtech Corporation
 Protection Products Division
 200 Flynn Rd., Camarillo, CA 93012
 Phone: (805)498-2111 FAX (805)498-3804

Looking for pricing, stock, or lifecycle information?

Click below to explore more details on WIN SOURCE:

-  [View RCLAMP0534N.TCT on WIN SOURCE](#)
-  [Semtech Corporation](#) Information

Optimize Your Supply Chain with WIN SOURCE Solutions

-  Global Sourcing Solution
-  Obsolete Management
-  Cost Control Management
-  Shortage Management
-  Alternative Solution
-  Excess Inventory Management