



**THE DATASHEET OF
UD4KB100-BP**





Micro Commercial Components



Micro Commercial Components
 20736 Marilla Street Chatsworth
 CA 91311
 Phone: (818) 701-4933
 Fax: (818) 701-4939

UD4KB05 THRU UD4KB100

4 Amp Glass Passivated Bridge Rectifier 50 to 1000 Volts

Features

- Lead Free Finish/RoHS Compliant (NOTE 1)("P" Suffix designates RoHS Compliant. See ordering information)
- High surge forward current capability
- Halogen free available upon request by adding suffix "-HF"
- Epoxy meets UL 94 V-0 flammability rating
- Moisture Sensitivity Level 1

Maximum Ratings

- Operating Temperature: -55°C to +150°C
- Storage Temperature: -55°C to +150°C
- Mounting Torque: 0.5 N•m
- UL Recognized File # E165989

MCC Catalog Number	Device Marking	Maximum Recurrent Peak Reverse Voltage	Maximum RMS Voltage	Maximum DC Blocking Voltage
UD4KB05	UD4KB05	50V	35V	50V
UD4KB10	UD4KB10	100V	70V	100V
UD4KB20	UD4KB20	200V	140V	200V
UD4KB40	UD4KB40	400V	280V	400V
UD4KB60	UD4KB60	600V	420V	600V
UD4KB80	UD4KB80	800V	560V	800V
UD4KB100	UD4KB100	1000V	700V	1000V

D3K

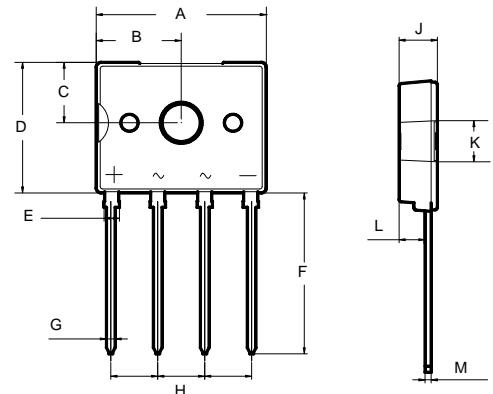

DIMENSIONS

DIM	INCHES		MM		NOTE
	MIN	MAX	MIN	MAX	
A	.524	.563	13.30	14.30	
B	.252	.291	6.40	7.40	
C	.177	.217	4.50	5.50	
D	.406	.445	10.30	11.30	
E	.041	.057	1.05	1.45	
F	.516	.531	13.10	13.50	
G	.024	.033	0.60	0.85	
H	.146	.154	3.70	3.90	
J	.102	.142	2.60	3.60	
K	.122	.134	3.10	3.40	
L	.079	.087	2.00	2.20	
M	.016	.024	0.40	0.60	

Electrical Characteristics @ 25°C Unless Otherwise Specified

Average Forward Current	$I_{F(AV)}$	4.0 A	$T_c = 140^\circ\text{C}$
Peak Forward Surge Current	I_{FSM}	135A	8.3ms, half sine
Maximum Instantaneous Forward Voltage	V_F	1.00V	$I_{FM} = 7.5A$ $T_J = 25^\circ\text{C}$
Maximum DC Reverse Current At Rated DC Blocking Voltage	I_R	10 μA	$T_a = 25^\circ\text{C}$
I^2t Rating for fusing	I^2t	75A ² S	(1ms < t < 8.3ms)
Thermal Resistance	R_{thJA} R_{thJC}	55°C/W 1.5°C/W	

Notes: 1. High Temperature Solder Exemption Applied, see EU Directive Annex Notes 7

RATING AND CHARACTERISTIC CURVES

FIG1: I_o - T_c Curve

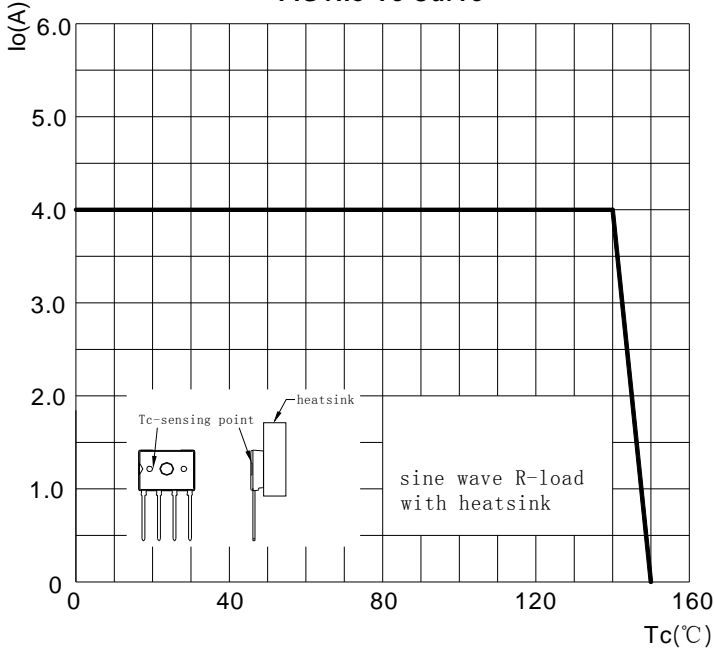

FIG2: Surge Forward Current Capability

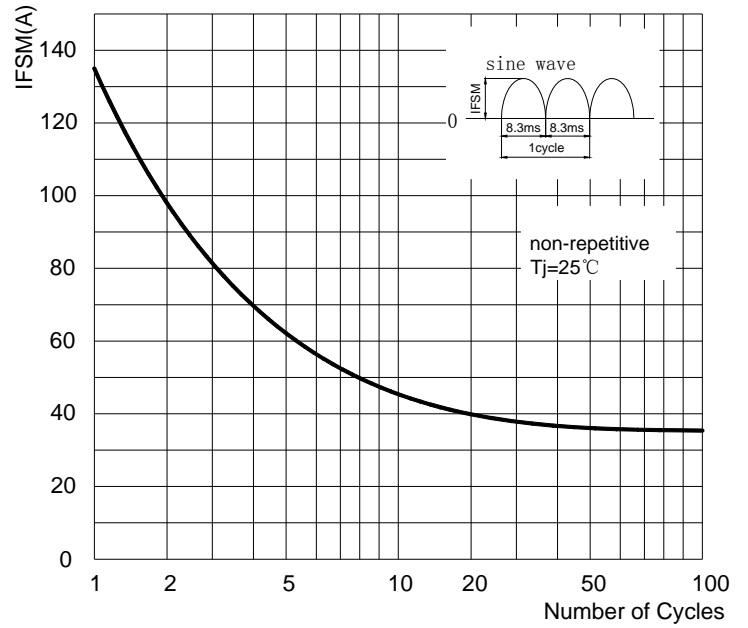

FIG3: Forward Voltage

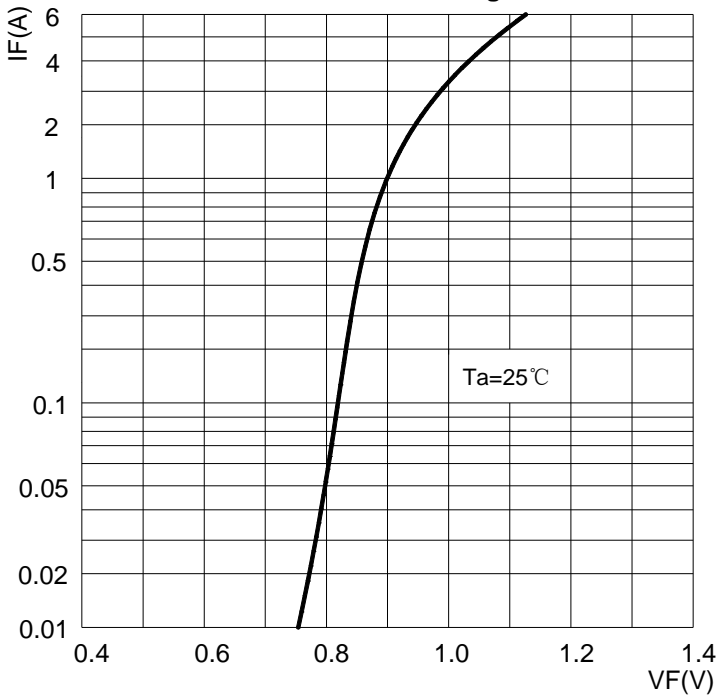
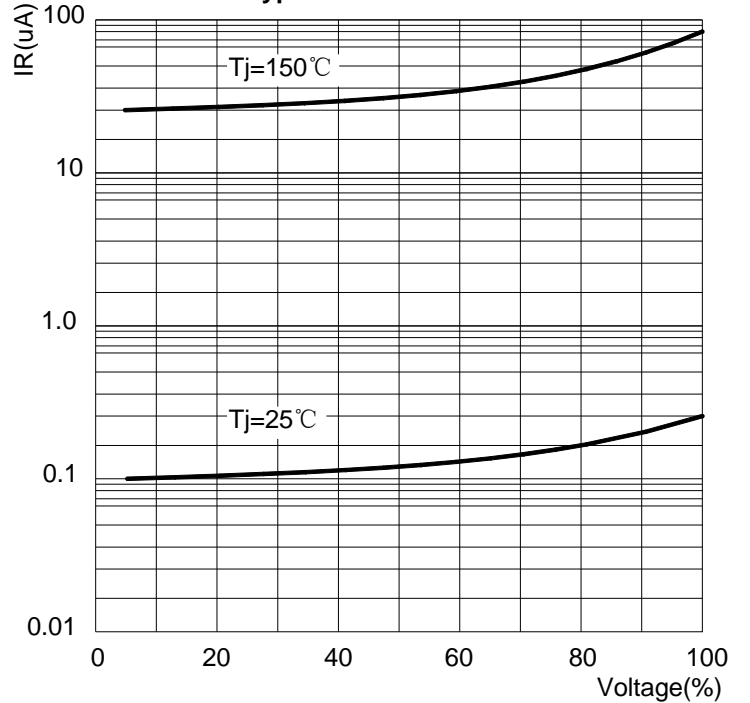

FIG4: Typical Reverse Characteristics





Micro Commercial Components

Ordering Information :

Device	Packing
Part Number-BP	Bulk: 1.5Kpcs/Box

Note : Adding "-HF" suffix for halogen free, eg. Part Number-BP-HF

IMPORTANT NOTICE

Micro Commercial Components Corp. reserves the right to make changes without further notice to any product herein to make corrections, modifications, enhancements, improvements, or other changes. Micro Commercial Components Corp. does not assume any liability arising out of the application or use of any product described herein; neither does it convey any license under its patent rights, nor the rights of others. The user of products in such applications shall assume all risks of such use and will agree to hold Micro Commercial Components Corp. and all the companies whose products are represented on our website, harmless against all damages.

LIFE SUPPORT

MCC's products are not authorized for use as critical components in life support devices or systems without the express written approval of Micro Commercial Components Corporation.



CUSTOMER AWARENESS

Counterfeiting of semiconductor parts is a growing problem in the industry. Micro Commercial Components (MCC) is taking strong measures to protect ourselves and our customers from the proliferation of counterfeit parts. MCC strongly encourages customers to purchase MCC parts either directly from MCC or from Authorized MCC Distributors who are listed by country on our web page cited below. Products customers buy either from MCC directly or from Authorized MCC Distributors are genuine parts, have full traceability, meet MCC's quality standards for handling and storage. MCC will not provide any warranty coverage or other assistance for parts bought from Unauthorized Sources. MCC is committed to combat this global problem and encourage our customers to do their part in stopping this practice by buying direct or from authorized distributors.

www.mccsemi.com

Looking for pricing, stock, or lifecycle information?

Click below to explore more details on WIN SOURCE:

-  [View UD4KB100-BP](#) on WIN SOURCE
-  [Micro Commercial Co](#) Information

Optimize Your Supply Chain with WIN SOURCE Solutions

-  Global Sourcing Solution
-  Obsolete Management
-  Cost Control Management
-  Shortage Management
-  Alternative Solution
-  Excess Inventory Management