



**THE DATASHEET OF
AP1681MTR-G1**



General Description

The AP1681 is a powerful high performance AC/DC power supply controller for dimmable LED lighting applications. The device uses Pulse Frequency Modulation (PFM) technology to regulate output current according to the wall dimmer conduct angle. The AP1681 achieves wide dimming range without visible flicker and is compatible with diverse dimmers.

The AP1681 features low start-up current, low operation current and high efficiency. It also has rich protection functions including over voltage, short circuit, over current and over temperature protections.

The AP1681 is available in SOIC-8 package.

Features

- Primary Side Control for Output Current Regulation Without Opto-coupler and Secondary CV/CC Control Circuitry
- Adjustable Full Brightness and Full Dimming Setting
- Wide Dimming Range From 100% to 1%, Down to Full Darkness
- Adjustable Dimming Curve for Human Eye Sensitivity
- No Visible Flicker
- Connectivity with Analog / Digital / Hybrid Dimming Mode
- Built-in Acceleration Start
- Adjustable Soft-start Timing
- CV Open-load Regulation and Reload Detection
- Over Voltage and Short Circuit Protection
- Over Temperature Protection
- Over Current Protection
- Maximum Switch On-time Protection

Applications

- Dimmable LED Driver Suit for Leading-edge Dimmer, Trailing-edge Dimmer, R Type, R-C Type or R-L Type Dimmer



Figure 1. Package Type of AP1681

Pin Configuration

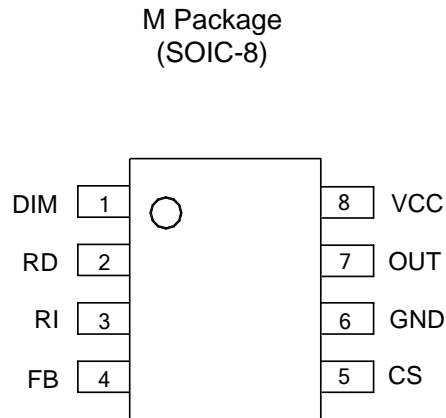

Figure 2. Pin Configuration of AP1681 (Top View)

Pin Description

Pin Number	Pin Name	Function
1	DIM	Dimming control signal input
2	RD	Full brightness level setting
3	RI	Full dimming level setting
4	FB	The feedback voltage sensing from the auxiliary winding
5	CS	Primary current sensing
6	GND	Ground. Current return for gate driver and control circuits of the IC
7	OUT	Gate driver output
8	VCC	Supply voltage of gate driver and control circuits of the IC

Functional Block Diagram

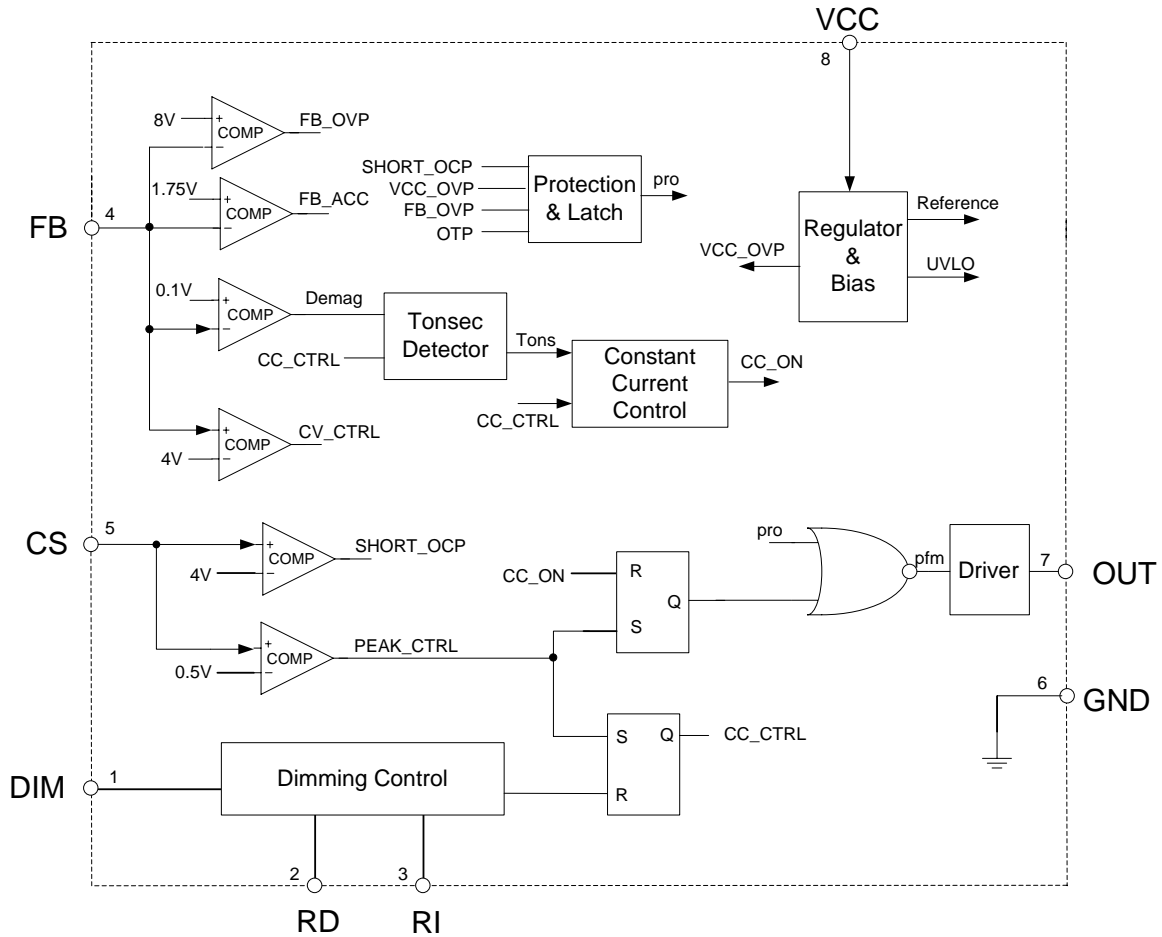
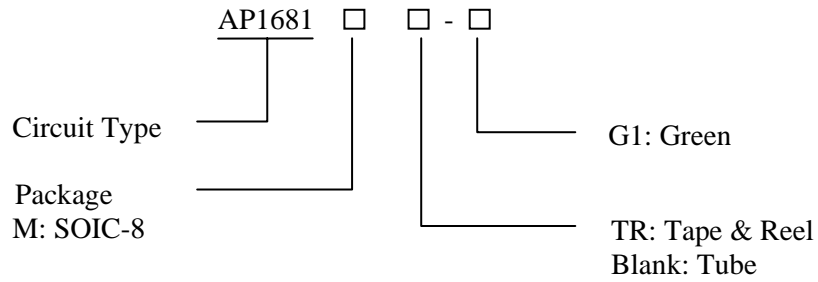

Figure 3. Functional Block Diagram of AP1681



Off-line Primary Side Regulation Controller for Dimmable LED Driver AP1681

Ordering Information



Package	Temperature Range	Part Number	Marking ID	Packing Type
SOIC-8	-40 to 105°C	AP1681M-G1	1681M-G1	Tube
		AP1681MTR-G1	1681M-G1	Tape & Reel

BCD Semiconductor's Pb-free products, as designated with "G1" suffix in the part number, are RoHS compliant and green.

**Absolute Maximum Ratings (Note 1)**

Parameter	Symbol	Value	Unit
Power Supply Voltage	V_{CC}	-0.3 to 30	V
Driver Output Current	I_{OUT}	± 300	mA
Voltage at RD, RI, DIM, CS	$V_{RD}, V_{RI},$ V_{DIM}, V_{CS}	-0.3 to 7	V
FB Input Voltage	V_{FB}	-40 to 10	V
Operating Junction Temperature	T_J	150	°C
Storage Temperature	T_{STG}	-65 to 150	°C
Lead Temperature (Soldering, 10 sec)	T_{LEAD}	300	°C
Power Dissipation at $T_A=50^\circ\text{C}$	P_D	0.65	W
Thermal Resistance (Junction-to-Ambient)	θ_{JA}	150	°C/W
ESD (Machine Model)		200	V
ESD (Human Body Model)		4000	V

Note 1: Stresses greater than those listed under “Absolute Maximum Ratings” may cause permanent damage to the device. These are stress ratings only, and functional operation of the device at these or any other conditions beyond those indicated under “Recommended Operating Conditions” is not implied. Exposure to “Absolute Maximum Ratings” for extended periods may affect device reliability.

Recommended Operating Conditions

Parameter	Symbol	Min	Max	Unit
Power Supply Voltage	V_{CC}	10.8	21.5	V
Ambient Temperature	T_A	-40	105	°C



Off-line Primary Side Regulation Controller for Dimmable LED Driver AP1681

Electrical Characteristics

V_{CC}=15V, T_A=25°C, unless otherwise specified.

Parameter	Symbol	Conditions	Min	Typ	Max	Unit
UVLO Section						
Start-up Threshold	V _{TH} (ST)		16.5	19	21.5	V
Minimal Operating Voltage	V _{OPR} (Min)	After turn on	7.2	9	10.8	
Standby Current Section						
Start-up Current	I _{ST}	V _{CC} =V _{TH} (ST)-0.5V, Before start up		1.7	10	μA
Operating Current	I _{CC}	Static	700	900	1100	
Drive Output Section						
Output High Level Voltage	V _{OH}	I _{GD-SOURCE} =20mA V _{CC} =12V	8			V
Output Low Level Voltage	V _{OL}	I _{GD-SINK} =20mA V _{CC} =12V			1	V
Output Voltage Rise Time	t _R	C _L =1nF	120	220	320	ns
Output Voltage Fall Time	t _F	C _L =1nF	30	50	90	ns
Output Clamp Voltage	V _{O-CLAMP}	I _{GD-SOURCE} =5mA V _{CC} =20V	11	13	15	V
UVLO Saturation Voltage	V _{UVLO}	V _{CC} =0 to V _{CC-ON} I _{SINK} =10mA			1	V
Maximum Switch On-time	t _{ONP_MAX}			16.5		μs
DIM Input Section						
Voltage Gain to RI		ΔV _{RI} /ΔV _{DIM}	-1.2	-1.1	-1.0	
Internal Source Current			11	20	35	μA
Reload Threshold			0.8	1	1.25	V
RD and RI Section						
RD Pin Voltage	V _{RD}		1.3	1.5	1.75	V
Maximum RD Current				150		μA
Maximum RI Current				250		μA
Current Sense Section						
Current Sense Voltage	V _{CS}		450	500	560	mV
Maximum CS Current		V _{DIM} =0		120		μA
Leading Edge Blanking				600		ns



Electrical Characteristics (Continued)

$V_{CC}=15V$, $T_A=25^{\circ}C$, unless otherwise specified.

Parameter	Symbol	Conditions	Min	Typ	Max	Unit
Feedback Input Section						
CV Feedback Threshold	V_{FB-CV}		3.0	4.0	5.0	V
FB Pin Input Leakage Current	I_{FB}	$V_{FB}=4V$	1.0	2	3.0	μA
Acceleration Start Threshold			1.35	1.75	2.15	V
Over Voltage Protection	V_{FB-OVP}		6.5	8	9.5	V
Over Temperature Protection Section						
Shutdown Temperature				140		$^{\circ}C$
Temperature Hysteresis				20		$^{\circ}C$

Typical Performance Characteristics

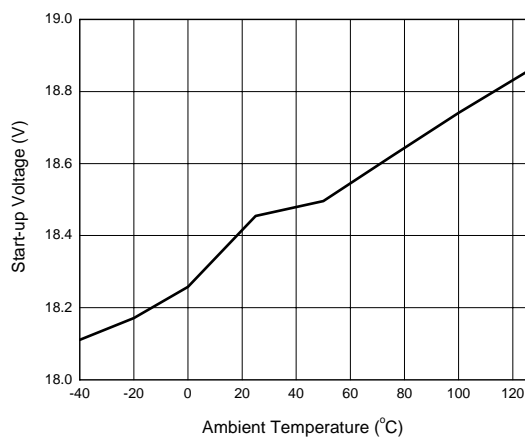

Figure 4. Start-up Voltage vs. Ambient Temperature

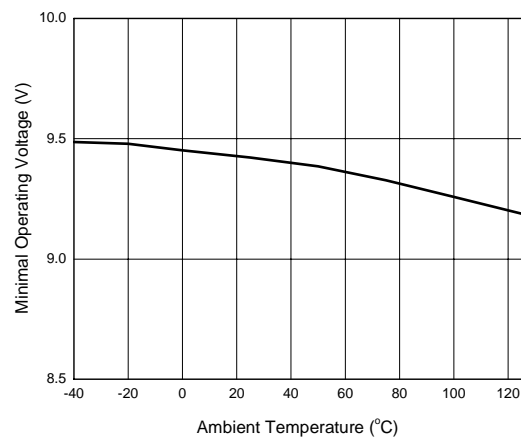

Figure 5. Minimal Operating Voltage vs. Ambient Temperature

Typical Performance Characteristics (Continued)

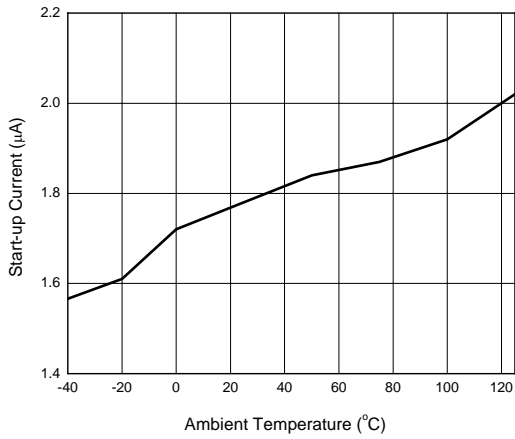

Figure 6. Start-up Current vs. Ambient Temperature

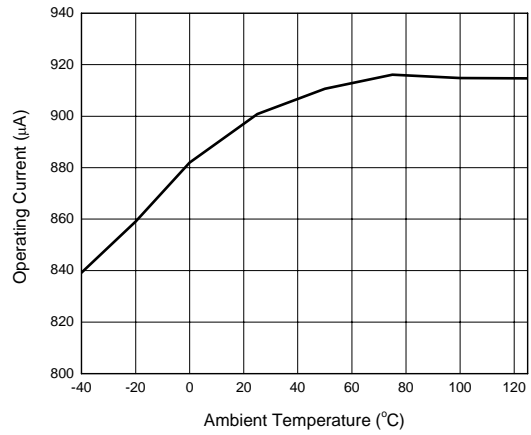

Figure 7. Operating Current vs. Ambient Temperature

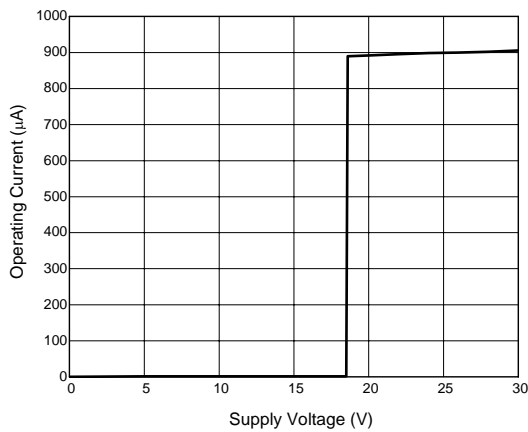

Figure 8. Operating Current vs. Supply Voltage

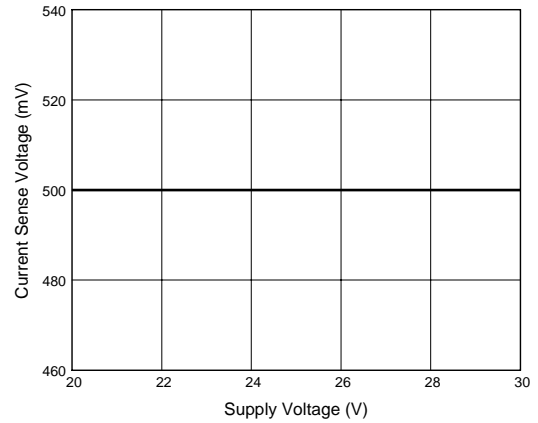

Figure 9. Current Sense Voltage vs. Supply Voltage



Typical Performance Characteristics (Continued)

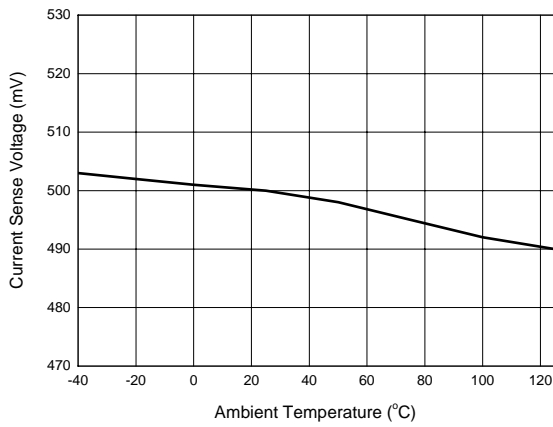

Figure 10. Current Sense Voltage vs. Ambient Temperature

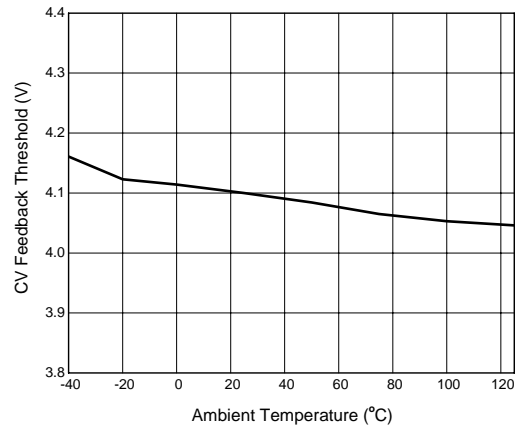

Figure 11. CV Feedback Threshold vs. Ambient Temperature

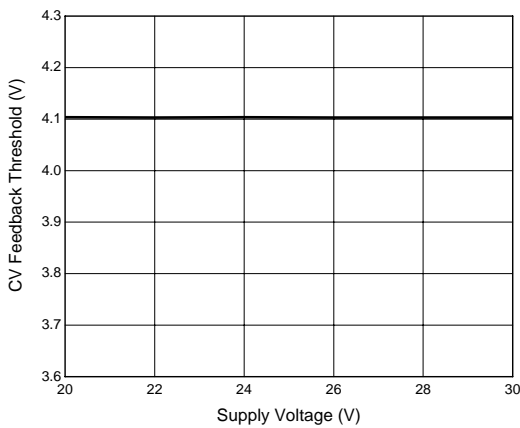

Figure 12. CV Feedback Threshold vs. Supply Voltage

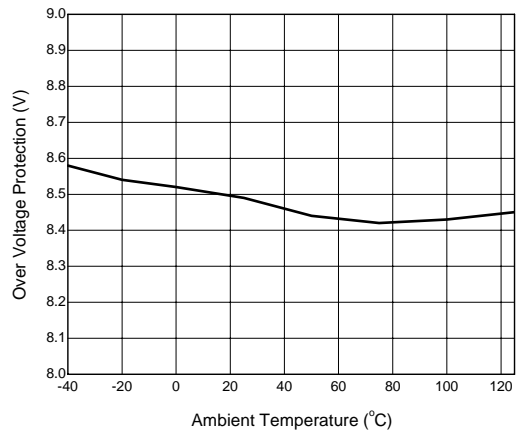

Figure 13. Over Voltage Protection vs. Ambient Temperature

Typical Performance Characteristics (Continued)

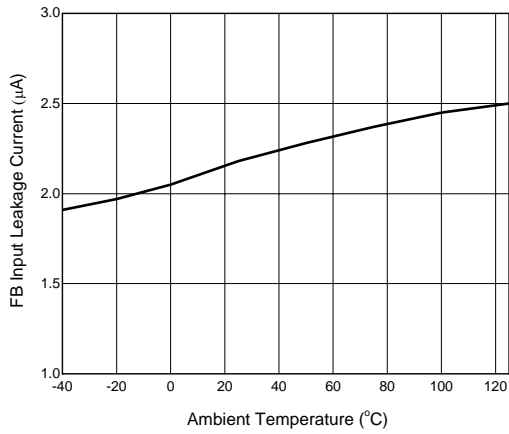

Figure 14. FB Input Leakage Current vs. Ambient Temperature

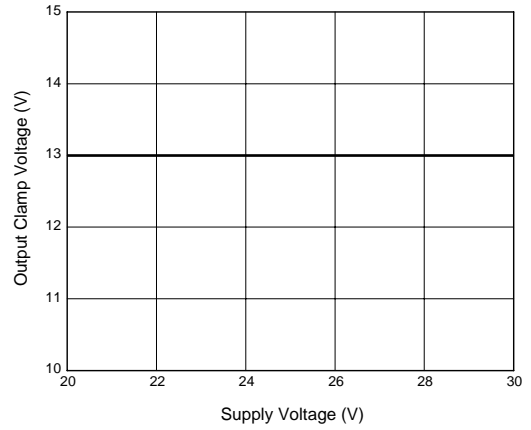

Figure 15. Output Clamp Voltage vs. Supply Voltage

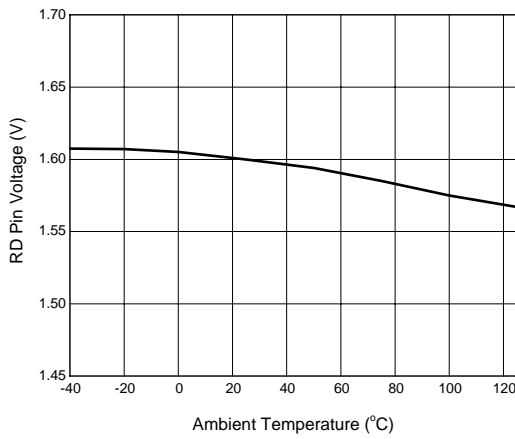

Figure 16. RD Pin Voltage vs. Ambient Temperature



BCD Semiconductor Manufacturing Limited

<http://www.bcdsemi.com>

IMPORTANT NOTICE

BCD Semiconductor Manufacturing Limited reserves the right to make changes without further notice to any products or specifications herein. BCD Semiconductor Manufacturing Limited does not assume any responsibility for use of any its products for any particular purpose, nor does BCD Semiconductor Manufacturing Limited assume any liability arising out of the application or use of any its products or circuits. BCD Semiconductor Manufacturing Limited does not convey any license under its patent rights or other rights nor the rights of others.

MAIN SITE

- Headquarters

BCD Semiconductor Manufacturing Limited

No. 1600, Zi Xing Road, Shanghai Zizhu Science-based Industrial Park, 200241, China
Tel: +86-21-24162266, Fax: +86-21-24162277

- Wafer Fab

Shanghai SIM-BCD Semiconductor Manufacturing Co., Ltd.

800 Yi Shan Road, Shanghai 200233, China
Tel: +86-21-6485 1491, Fax: +86-21-5450 0008

REGIONAL SALES OFFICE

Shenzhen Office

Shanghai SIM-BCD Semiconductor Manufacturing Co., Ltd., Shenzhen Office

Unit A Room 1203, Skyworth Bldg., Gaoxin Ave. 1.S., Nanshan District, Shenzhen, China
Tel: +86-755-8826 7951
Fax: +86-755-8826 7865

Taiwan Office

BCD Semiconductor (Taiwan) Company Limited

4F, 298-1, Rui Guang Road, Nei-Hu District, Taipei, Taiwan
Tel: +886-2-2656 2808
Fax: +886-2-2656 2806

USA Office

BCD Semiconductor Corp.

30920 Huntwood Ave. Hayward, CA 94544, USA
Tel : +1-510-324-2988
Fax: +1-510-324-2788

Looking for pricing, stock, or lifecycle information?

Click below to explore more details on WIN SOURCE:

-  [View AP1681MTR-G1 on WIN SOURCE](#)
-  [Diodes Incorporated Information](#)

Optimize Your Supply Chain with WIN SOURCE Solutions

-  Global Sourcing Solution
-  Obsolete Management
-  Cost Control Management
-  Shortage Management
-  Alternative Solution
-  Excess Inventory Management