



**THE DATASHEET OF  
IXDI402SIA**



### Features

- Built using the advantages and compatibility of CMOS and IXYS HDMOS™ processes
- Latch-Up Protected up to 0.5A
- High Peak Output Current: 2A Peak
- Wide Operating Range: 4.5V to 35V
- -55°C to +125°C Extended Operating Temperature Standard
- High Capacitive Load Drive Capability: 1000pF in <10ns
- Matched Rise And Fall Times
- Low Propagation Delay Time
- Low Output Impedance
- Low Supply Current
- Two Drivers in Single Chip

### Applications

- Driving MOSFETs and IGBTs
- Motor Controls
- Line Drivers
- Pulse Generators
- Local Power ON/OFF Switch
- Switch Mode Power Supplies (SMPS)
- DC to DC Converters
- Pulse Transformer Driver
- Class D Switching Amplifiers

### General Description

The IXDN402/IXDI402/IXDF402 consists of two 2 Amp CMOS high speed MOSFET drivers. Each output can source and sink 2A of peak current while producing voltage rise and fall times of less than 15ns to drive the latest IXYS MOSFETs & IGBTs. The input of the driver is TTL or CMOS compatible and is fully immune to latch up over the entire operating range. A patent-pending circuit virtually eliminates cross conduction and current shoot-through. Improved speed and drive capabilities are further enhanced by very low and matched rise and fall times.

The IXDN402 is configured as a dual non-inverting gate driver, the IXDI402 as a dual inverting gate driver, and the IXDF402 as a dual inverting + non-inverting gate driver.

The IXDN402/IXDI402/IXDF402 family are available in the standard 8 pin P-DIP (PI), SOIC-8 (SIA) and SOIC-16 (SIA-16) packages. For enhanced thermal performance, the SOIC-8 and SOIC-16 are also available with an exposed grounded backmetal package as the SI and SI-16 respectively.

### Ordering Information

Part Number	Package Type	Temp. Range	Configuration
IXDN402PI	8-Pin PDIP	-55°C to +125°C	Dual Non Inverting
IXDN402SI	8-Pin SOIC with Grounded Backmetal		
IXDN402SIA	8-Pin SOIC		
IXDN402SI-16	16-Pin SOIC with Grounded Backmetal		
IXDN402SIA-16	16-Pin SOIC		
IXDI402PI	8-Pin PDIP	-55°C to +125°C	Dual Inverting
IXDI402SI	8-Pin SOIC with Grounded Backmetal		
IXDI402SIA	8-Pin SOIC		
IXDI402SI-16	16-Pin SOIC with Grounded Backmetal		
IXDI402SIA-16	16-Pin SOIC		
IXDF402PI	8-Pin PDIP	-55°C to +125°C	Inverting + Non Inverting
IXDF402SI	8-Pin SOIC with Grounded Backmetal		
IXDF402SIA	8-Pin SOIC		
IXDF402SI-16	16-Pin SOIC with Grounded Backmetal		
IXDF402SIA-16	16-Pin SOIC		

**NOTE:** Mounting or solder tabs on all packages are connected to ground

**Figure 1 - IXDN402 Dual 2A Non-Inverting Gate Driver Functional Block Diagram**

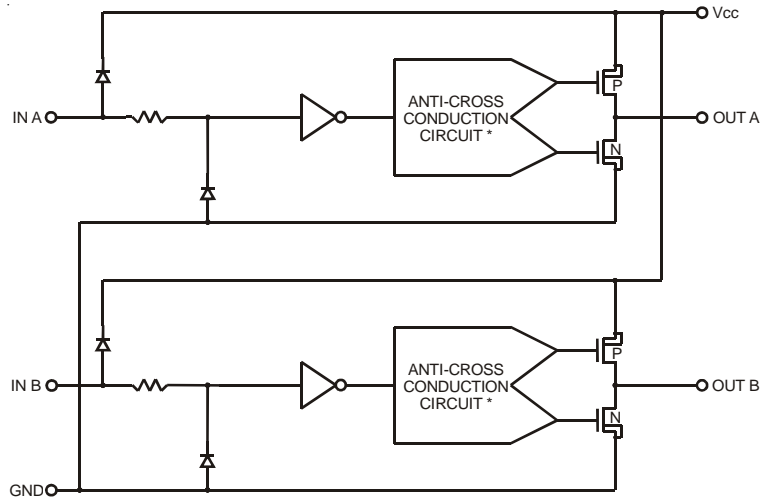

**Figure 2 - IXDI402 Dual Inverting 2A Gate Driver Functional Block Diagram**

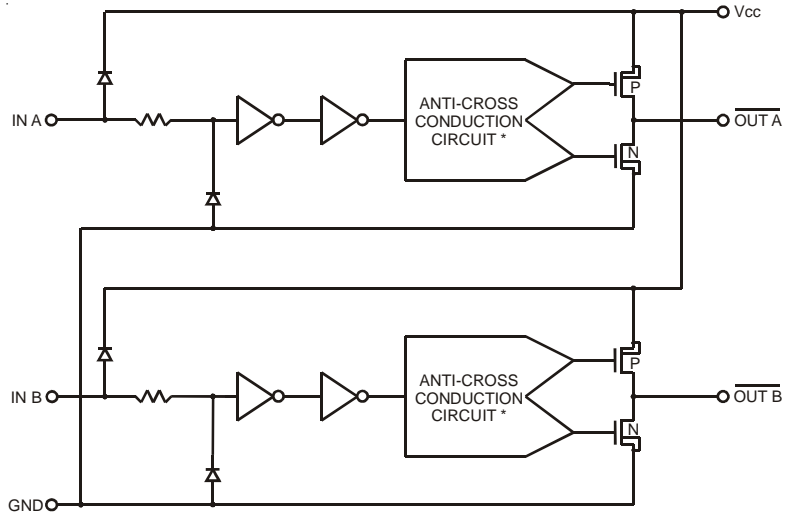

**Figure 3 - IXDF402 Inverting + Non-Inverting 2A Gate Driver Functional Block Diagram**

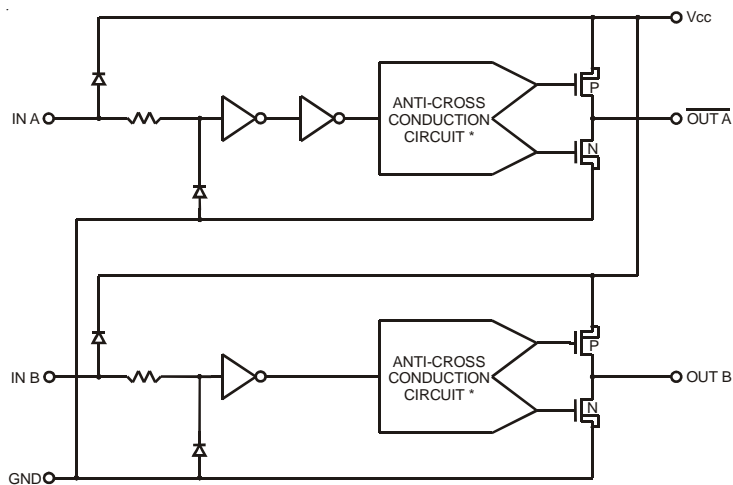

\* Patent Pending

**Absolute Maximum Ratings** (Note 1)

Parameter	Value
Supply Voltage	40 V
All Other Pins	-0.3 V to $V_{CC} + 0.3$ V
Junction Temperature	150 °C
Storage Temperature	-65 °C to 150 °C
Lead Temperature (10 sec)	300 °C
Thermal Resistance (Junction to Case) ( $\theta_{JC}$ )	
8 Pin SOIC (SI)	10 K/W
16 Pin SOIC (SI-16)	10 K/W

**Operating Ratings**

Parameter	Value
Operating Temperature Range	-55 °C to 125 °C
Thermal Resistance (To Ambient)	
8 Pin PDIP (PI) ( $\theta_{JA}$ )	130 K/W
8 Pin SOIC (SIA)	120 K/W
16 Pin SOIC (SIA-16) ( $\theta_{JA}$ )	120 K/W
$\theta_{JA}$ with heat sink **	
Heat sink area of 1 cm <sup>2</sup>	
8 Pin SOIC	100 K/W
16 Pin SOIC-CT	100 K/W
Heat sink area of 3 cm <sup>2</sup>	
8 Pin SOIC	90 K/W
16 Pin SOIC-CT	90 K/W

\*\* Device soldered to metal back pane. Heat sink area is 1 oz. copper on 1 side of 0.06" thick FR4 PC board.

**Electrical Characteristics**

Unless otherwise noted,  $T_A = 25$  °C,  $4.5V \leq V_{CC} \leq 35V$ .

All voltage measurements with respect to GND. IXDD402 configured as described in *Test Conditions*. All specifications are for one channel.

Symbol	Parameter	Test Conditions	Min	Typ	Max	Units
$V_{IH}$	High input voltage	$4.5V \leq V_{CC} \leq 18V$	3			V
$V_{IL}$	Low input voltage	$4.5V \leq V_{CC} \leq 18V$			0.8	V
$V_{IN}$	Input voltage range		-5		$V_{CC} + 0.3$	V
$I_{IN}$	Input current	$0V \leq V_{IN} \leq V_{CC}$	-10		10	$\mu$ A
$V_{OH}$	High output voltage		$V_{CC} - 0.025$			V
$V_{OL}$	Low output voltage				0.025	V
$R_{OH}$	Output resistance @ Output high	$V_{CC} = 18V$		3.7	4	$\Omega$
$R_{OL}$	Output resistance @ Output Low	$V_{CC} = 18V$		2.5	3	$\Omega$
$I_{PEAK}$	Peak output current	$V_{CC}$ is 18V		2		A
$I_{DC}$	Continuous output current				1	A
$t_R$	Rise time	$C_L=1000pF$ $V_{CC}=18V$		8	10	ns
$t_F$	Fall time	$C_L=1000pF$ $V_{CC}=18V$		8	9	ns
$t_{ONDLY}$	On-time propagation delay	$C_L=1000pF$ $V_{CC}=18V$		28	32	ns
$t_{OFFDLY}$	Off-time propagation delay	$C_L=1000pF$ $V_{CC}=18V$		26	30	ns
$V_{CC}$	Power supply voltage		4.5	18	35	V
$I_{CC}$	Power supply current	$V_{IN} = 3.5V$		1	3	mA
		$V_{IN} = 0V$		0	10	$\mu$ A
		$V_{IN} = + V_{CC}$			10	$\mu$ A

Specifications Subject To Change Without Notice

**Note 1:** Operating the device beyond the parameters listed as "Absolute Maximum Ratings" may cause permanent damage to the device. Typical values indicate conditions for which the device is intended to be functional, but do not guarantee specific performance limits. The guaranteed specifications apply only for the test conditions listed. Exposure to absolute maximum rated conditions for extended periods may affect device reliability.

## Electrical Characteristics

Unless otherwise noted, temperature over -55°C to 150°C,  $4.5V \leq V_{CC} \leq 35V$ .

All voltage measurements with respect to GND. IXDD402 configured as described in *Test Conditions*. All specifications are for one channel.

Symbol	Parameter	Test Conditions	Min	Typ	Max	Units
$V_{IH}$	High input voltage	$4.5V \leq V_{CC} \leq 18V$	3.1			V
$V_{IL}$	Low input voltage	$4.5V \leq V_{CC} \leq 18V$			0.8	V
$V_{IN}$	Input voltage range		-5		$V_{CC} + 0.3$	V
$I_{IN}$	Input current	$0V \leq V_{IN} \leq V_{CC}$	-10		10	$\mu A$
$V_{OH}$	High output voltage		$V_{CC} - 0.025$			V
$V_{OL}$	Low output voltage				0.025	V
$R_{OH}$	Output resistance @ Output high	$V_{CC} = 18V$			7	$\Omega$
$R_{OL}$	Output resistance @ Output Low	$V_{CC} = 18V$			5	$\Omega$
$I_{PEAK}$	Peak output current	$V_{CC} = 18V$	1.5			A
$I_{DC}$	Continuous output current				1	A
$t_R$	Rise time	$C_L=1000pF$ $V_{CC}=18V$			13	ns
$t_F$	Fall time	$C_L=1000pF$ $V_{CC}=18V$			12	ns
$t_{ONDLY}$	On-time propagation delay	$C_L=1000pF$ $V_{CC}=18V$			40	ns
$t_{OFFDLY}$	Off-time propagation delay	$C_L=1000pF$ $V_{CC}=18V$			38	ns
$V_{CC}$	Power supply voltage		4.5	18	35	V
$I_{CC}$	Power supply current	$V_{IN} = 3.5V$ $V_{IN} = 0V$ $V_{IN} = + V_{CC}$		1 0	3 10	mA $\mu A$
					10	$\mu A$

Specifications Subject To Change Without Notice

Pin Description

SYMBOL	FUNCTION	DESCRIPTION
IN A	A Channel Input	A Channel Input signal-TTL or CMOS compatible.
GND	Ground	The system ground pin. Internally connected to all circuitry, this pin provides ground reference for the entire chip. This pin should be connected to a low noise analog ground plane for optimum performance.
IN B	B Channel Input	B Channel Input signal-TTL or CMOS compatible.
OUT B	B Channel Output	B Channel Driver output. For application purposes, this pin is connected via a resistor to a gate of a MOSFET/IGBT.
VCC	Supply Voltage	Positive power-supply voltage input. This pin provides power to the entire chip. The range for this voltage is from 4.5V to 35V.
OUT A	A Channel Output	A Channel Driver output. For application purposes, this pin is connected via a resistor to a gate of a MOSFET/IGBT.

**CAUTION:** These devices are sensitive to electrostatic discharge. Follow proper ESD procedures when handling and assembling this component.

Figure 4 - Characteristics Test Diagram

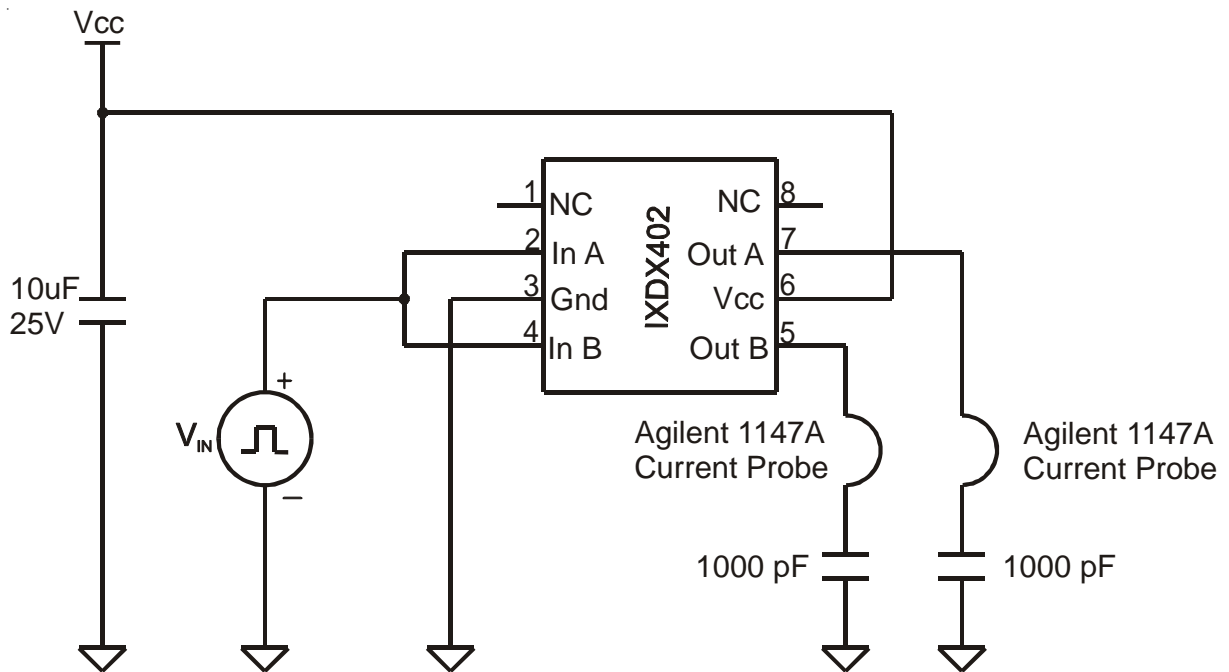

### Typical Performance Characteristics

Fig. 5 Rise Time vs. Supply Voltage  
CL = 100pF to 6800pF

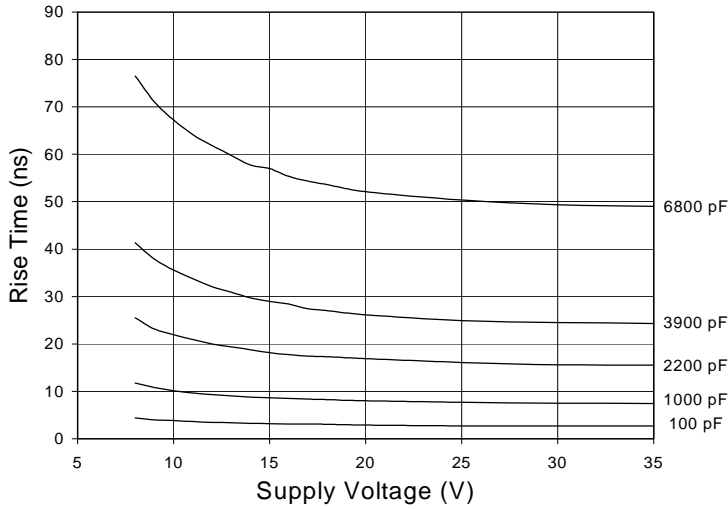

Fig. 6 Fall Time vs. Supply Voltage  
CL = 100pF to 6800pF

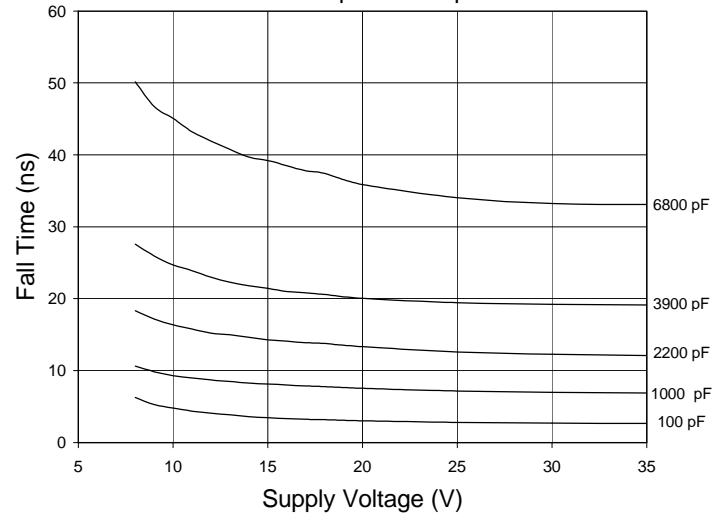

Fig. 7 Rise And Fall Times vs. Case Temperature  
CL = 1000pF, Vcc = 18V

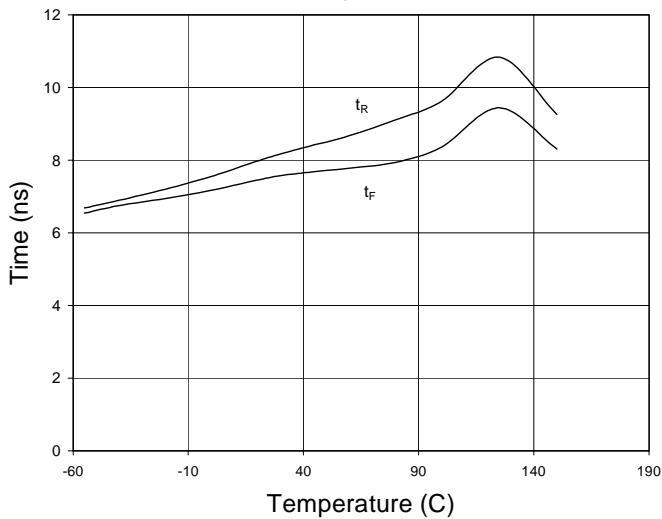

Fig. 8 Output Rise Times vs. Load Capacitance

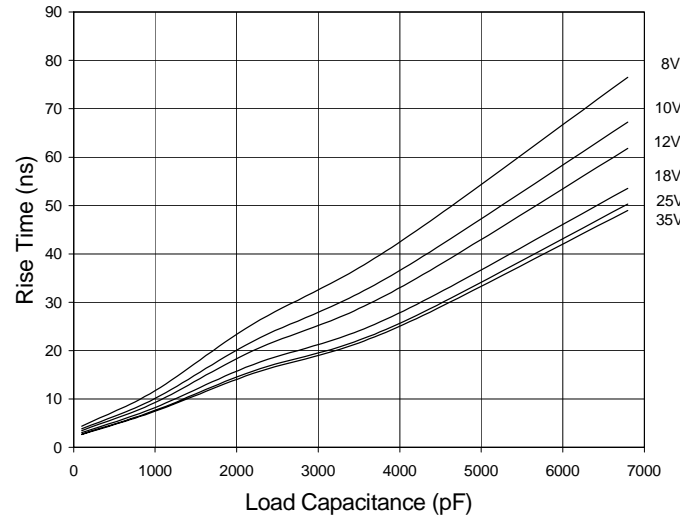

Fig. 9 Output Fall Times vs. Load Capacitance

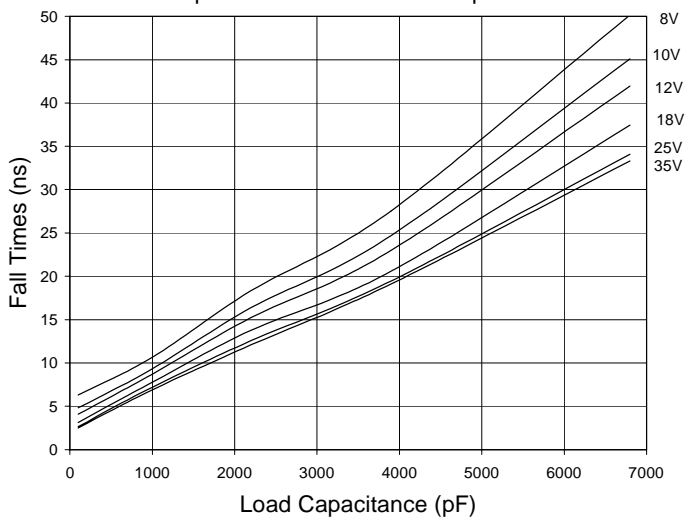
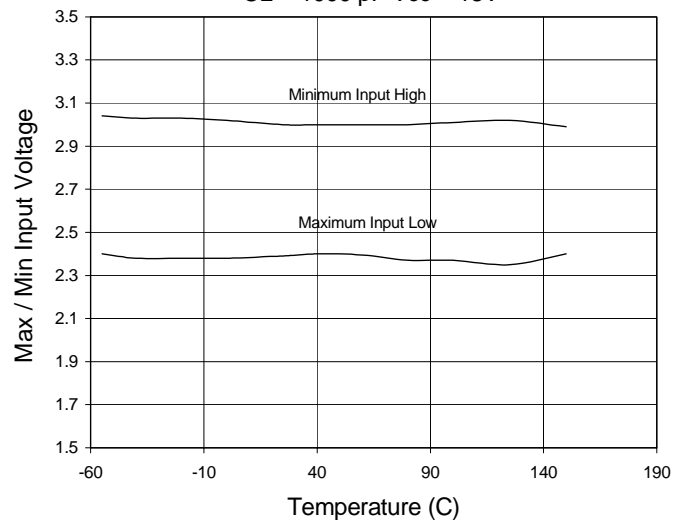
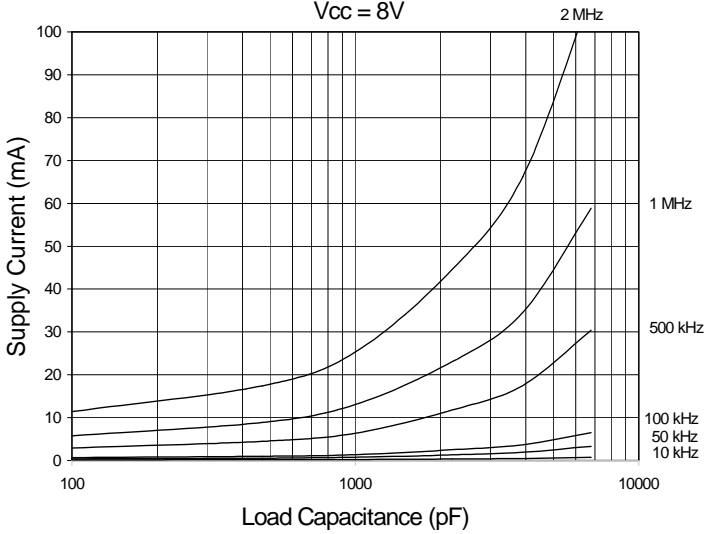

Fig. 10 Max / Min Input vs. Temperature  
CL = 1000 pF Vcc = 18V



**Fig. 11** Supply Current vs. Load Capacitance  
V<sub>CC</sub> = 8V



**Fig. 12** Supply Current vs. Frequency  
V<sub>CC</sub> = 8V

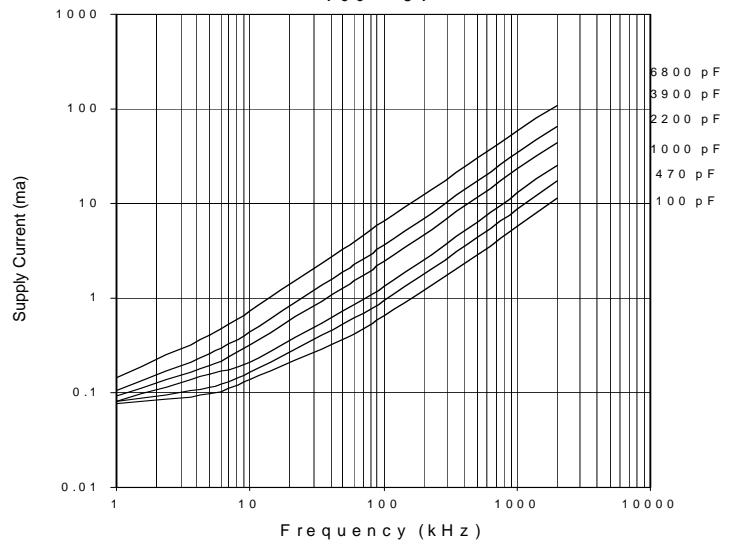

**Fig. 13** Supply Current vs. Load Capacitance  
V<sub>CC</sub> = 12V

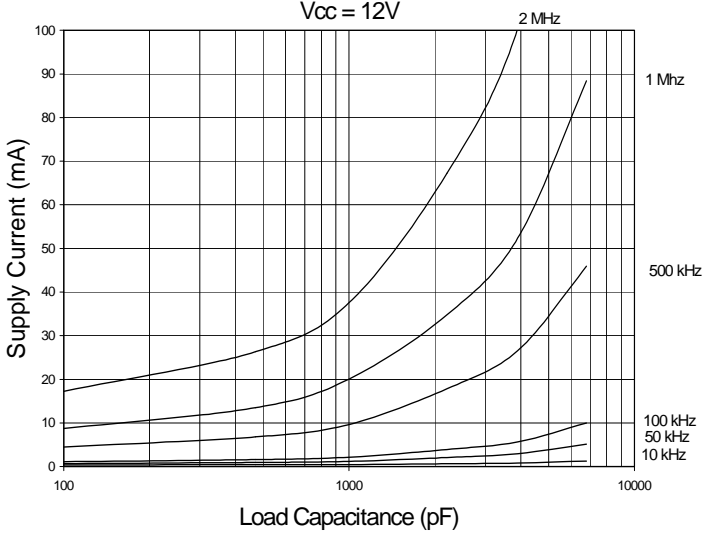

**Fig. 14** Supply Current vs. Frequency  
V<sub>CC</sub> = 12V

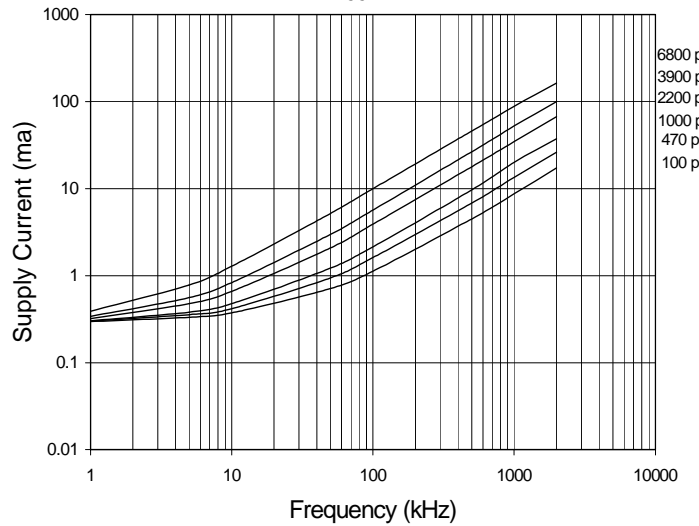

**Fig. 15** Supply Current vs. Load Capacitance  
V<sub>CC</sub> = 18V

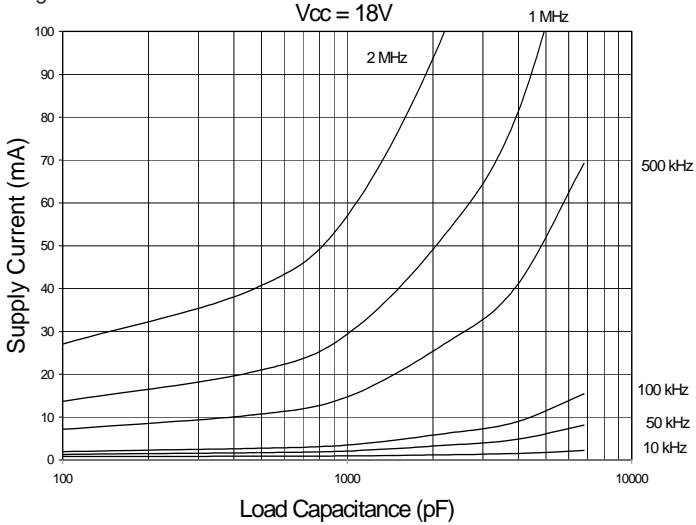

**Fig. 16** Supply Current vs. Frequency  
V<sub>CC</sub> = 18V

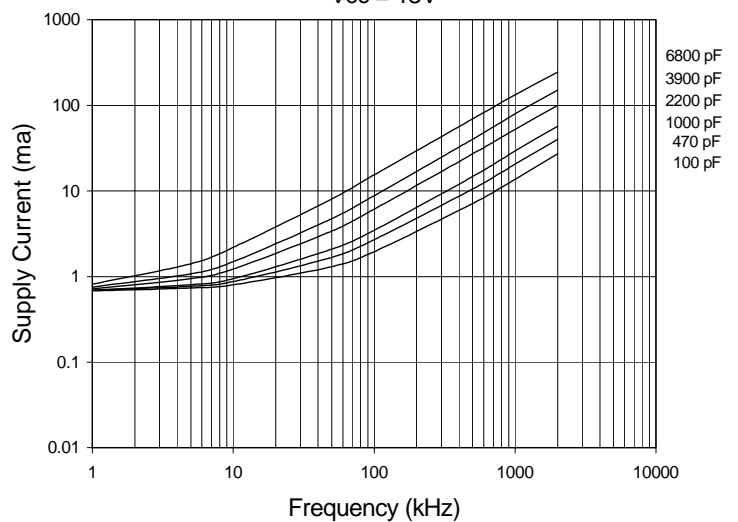

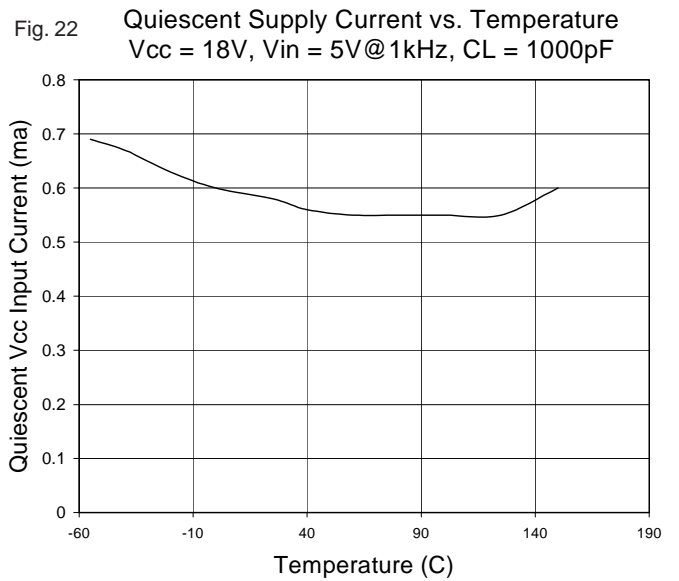
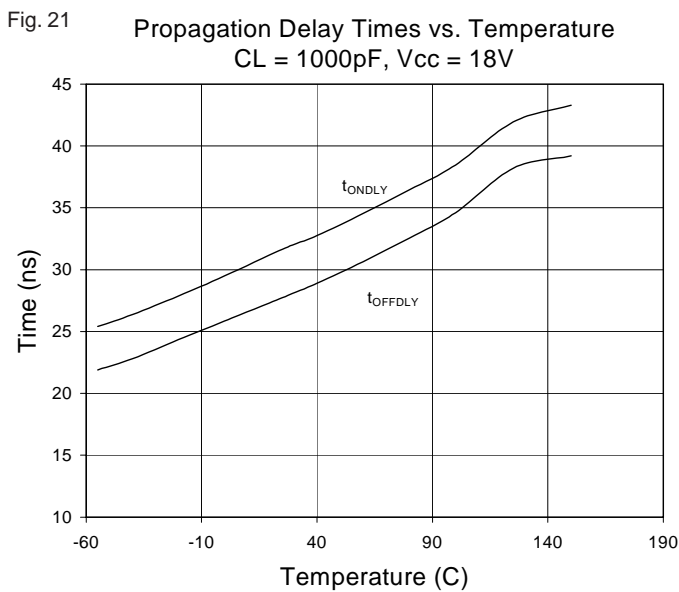
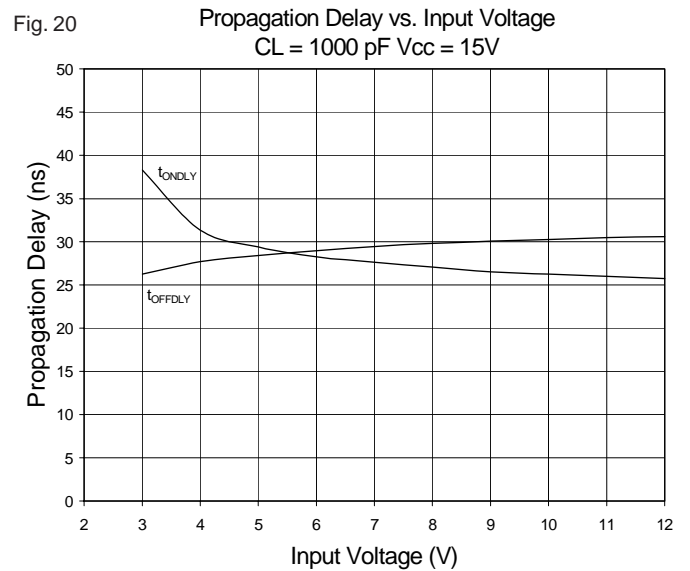
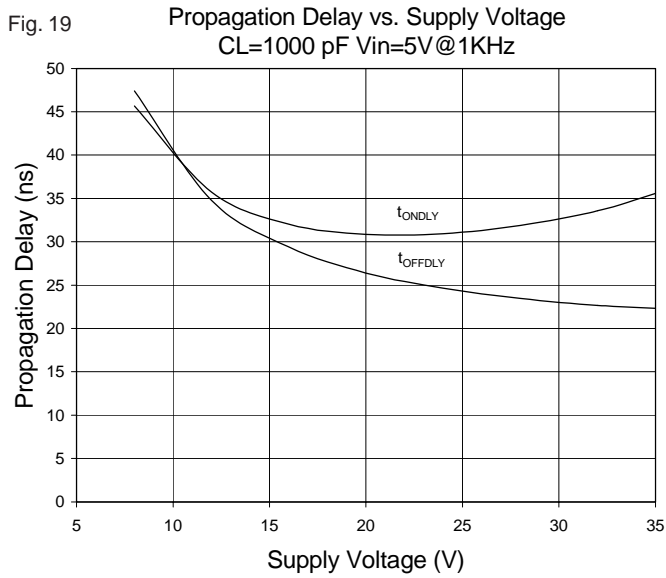
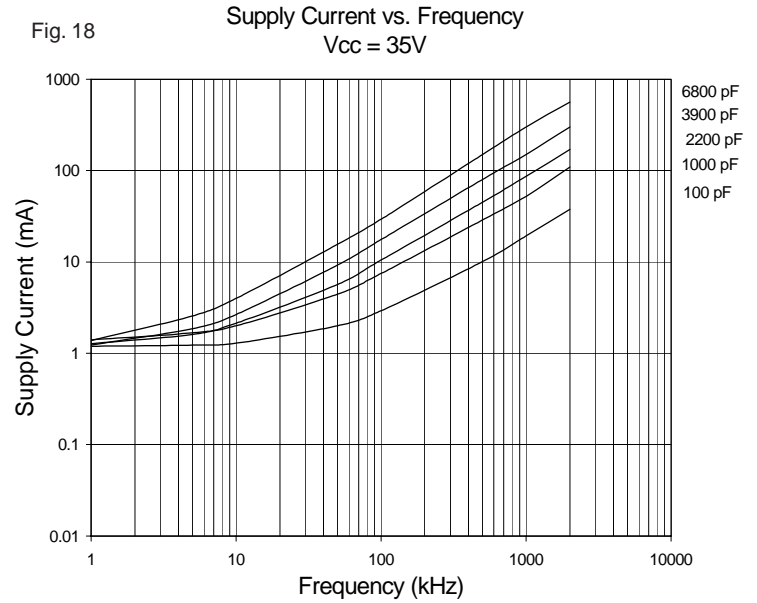
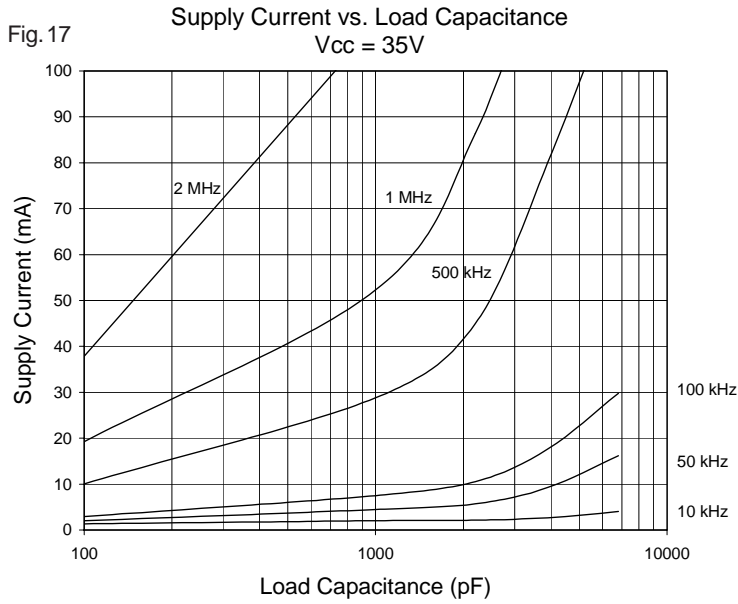

Fig. 23 High State Output Resistance vs. Supply Voltage

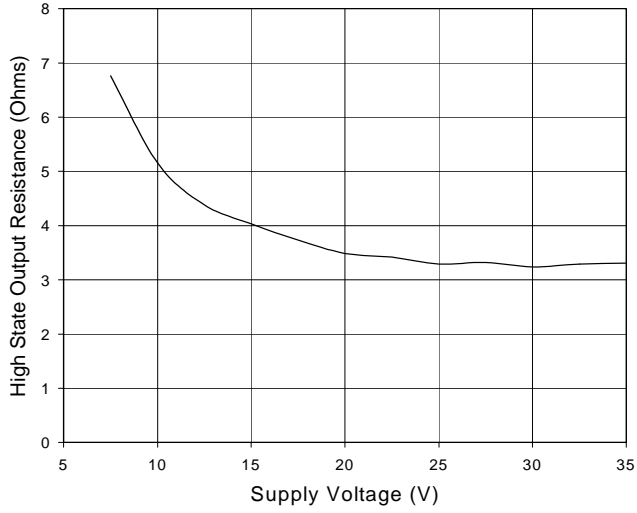

Fig. 24 Low State Output Resistance vs. Supply Voltage

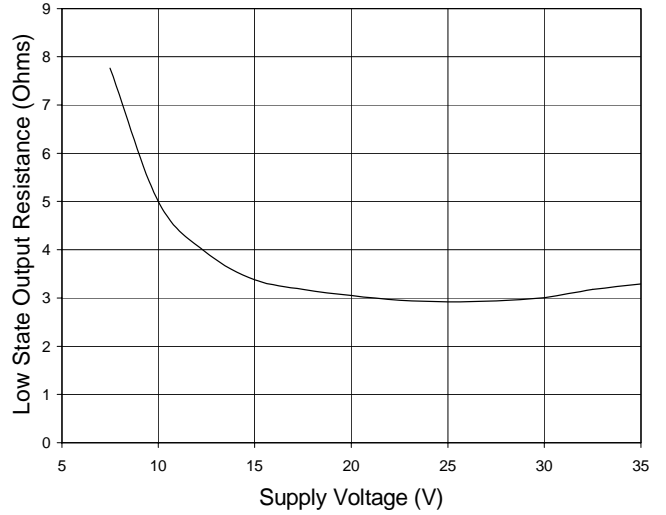

Fig. 25

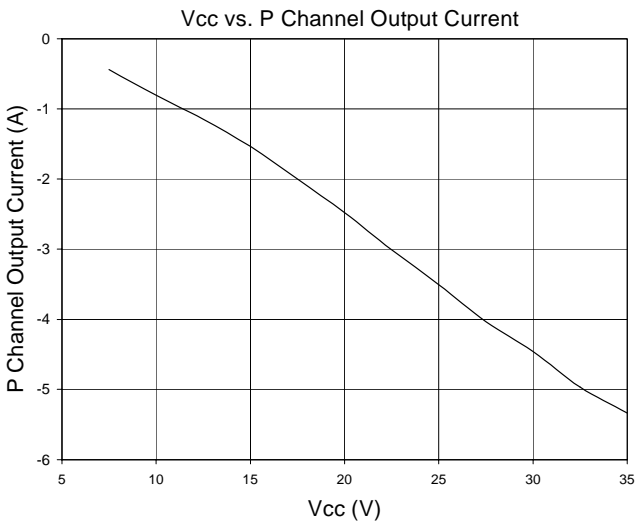

Fig. 26

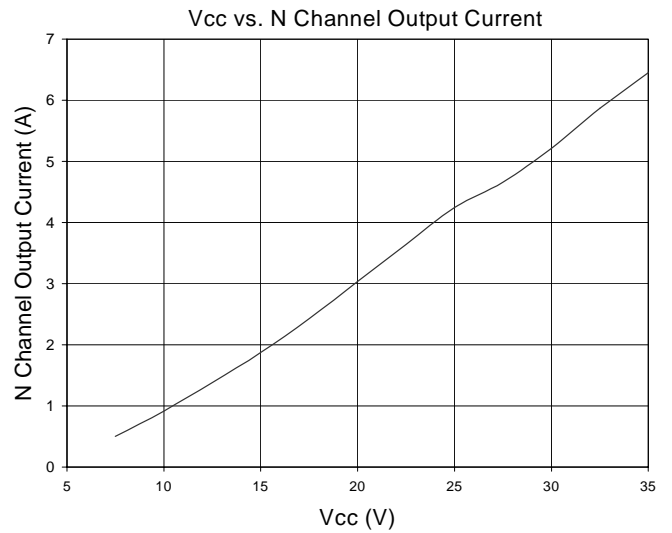

Fig. 27 P Channel Source Output Current vs. Temperature  
Vcc = 18V, CL = 1000 pF

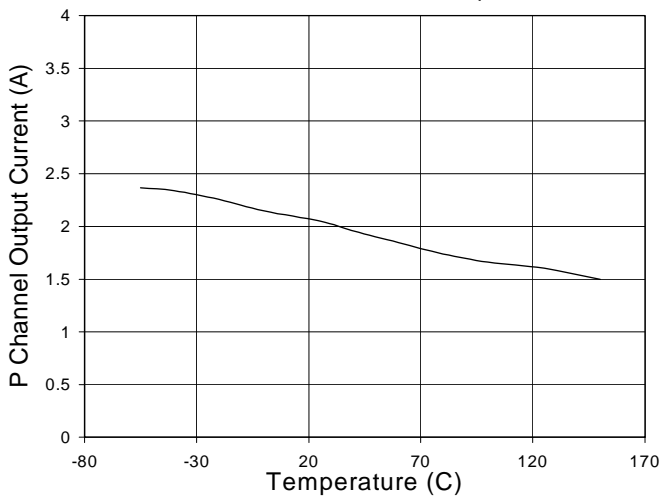
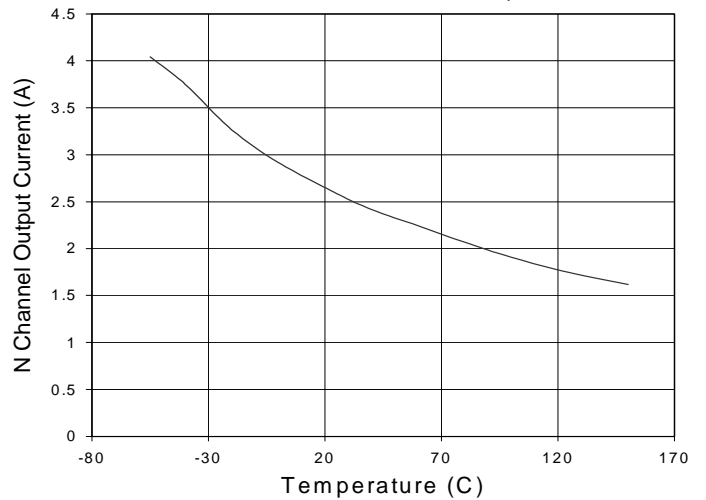
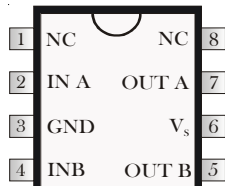

Fig. 28 N Channel Output Current vs. Temperature  
Vcc = 18V CL = 1000 pF



## PIN CONFIGURATIONS



8 Lead PDIP (PI)  
8 Pin SOIC (SI)  
IXDN402

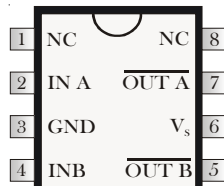

8 Lead PDIP (PI)  
8 Pin SOIC (SI)  
IXDI402

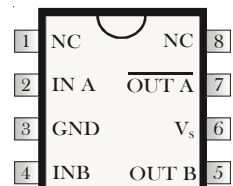

8 Lead PDIP (PI)  
8 Pin SOIC (SI)  
IXDF402

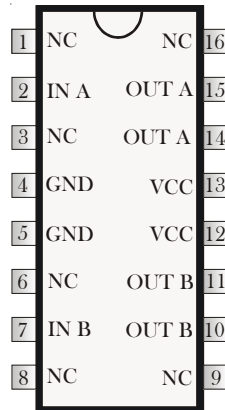

16 Pin SOIC  
IXDN402SI-16

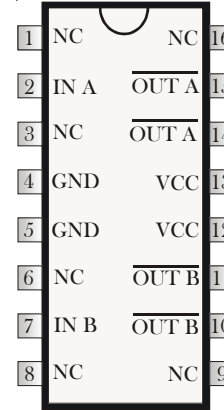

16 Pin SOIC  
IXDI402SI-16

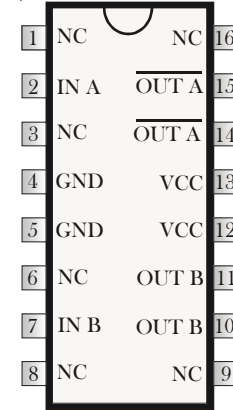

16 Pin SOIC  
IXDF402SI-16

### Supply Bypassing, Grounding Practices And Output Lead inductance

When designing a circuit to drive a high speed MOSFET utilizing the IXDN402/IXDI402/IXDF402, it is very important to observe certain design criteria in order to optimize performance of the driver. Particular attention needs to be paid to **Supply Bypassing, Grounding,** and minimizing the **Output Lead Inductance.**

Say, for example, we are using the IXDN402 to charge a 1500pF capacitive load from 0 to 25 volts in 25ns.

Using the formula:  $I = \Delta V C / \Delta t$ , where  $\Delta V = 25V$ ,  $C = 1500pF$  &  $\Delta t = 25ns$ , we can determine that to charge 1500pF to 25 volts in 25ns will take a constant current of 1.5A. (In reality, the charging current won't be constant, and will peak somewhere around 2A).

#### SUPPLY BYPASSING

In order for our design to turn the load on properly, the IXDN402 must be able to draw this 1.5A of current from the power supply in the 25ns. This means that there must be very low impedance between the driver and the power supply. The most common method of achieving this low impedance is to bypass the power supply at the driver with a capacitance value that is an order of magnitude larger than the load capacitance. Usually, this would be achieved by placing two different types of bypassing capacitors, with complementary impedance curves, very close to the driver itself. (These capacitors should be carefully selected and should have low inductance, low resistance and high-pulse current-service ratings). Lead lengths may radiate at high frequency due to inductance, so care should be taken to keep the lengths of the leads between these bypass capacitors and the IXDN402 to an absolute minimum.

#### GROUNDING

In order for the design to turn the load off properly, the IXDN402 must be able to drain this 1.5A of current into an adequate grounding system. There are three paths for returning current that need to be considered: Path #1 is between the IXDN402 and its load. Path #2 is between the IXDN402 and its power supply. Path #3 is between the IXDN402 and whatever logic is driving it. All three of these paths should be as low in resistance and inductance as possible, and thus as short as practical. In addition, every effort should be made to keep these three ground paths distinctly separate. Otherwise, the returning ground current from the load may develop a voltage that would have a detrimental effect on the logic line driving the IXDN402.

#### OUTPUT LEAD INDUCTANCE

Of equal importance to Supply Bypassing and Grounding are issues related to the Output Lead Inductance. Every effort should be made to keep the leads between the driver and its load as short and wide as possible. If the driver must be placed farther than 2" (5mm) from the load, then the output leads should be treated as transmission lines. In this case, a twisted-pair should be considered, and the return line of each twisted pair should be placed as close as possible to the ground pin of the driver, and connected directly to the ground terminal of the load.

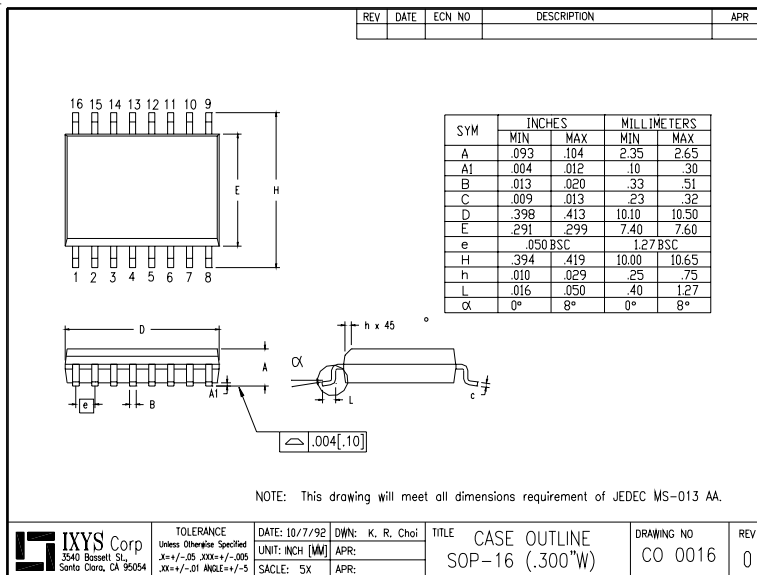
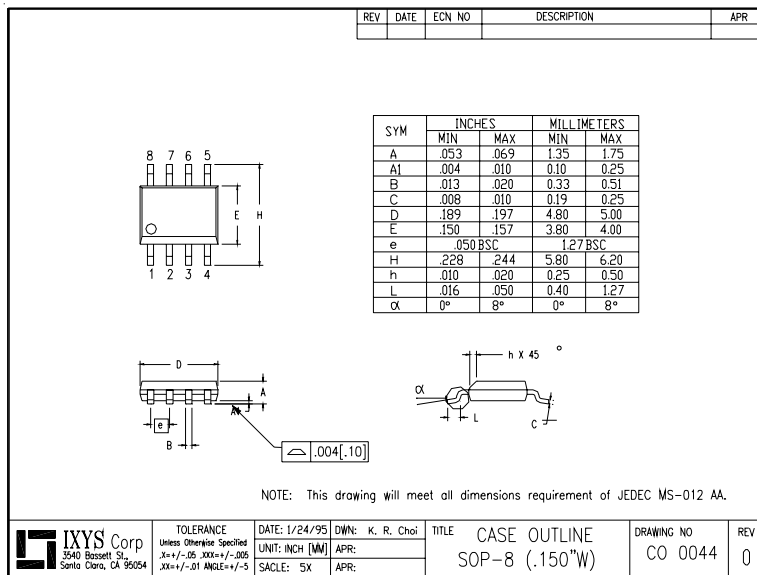
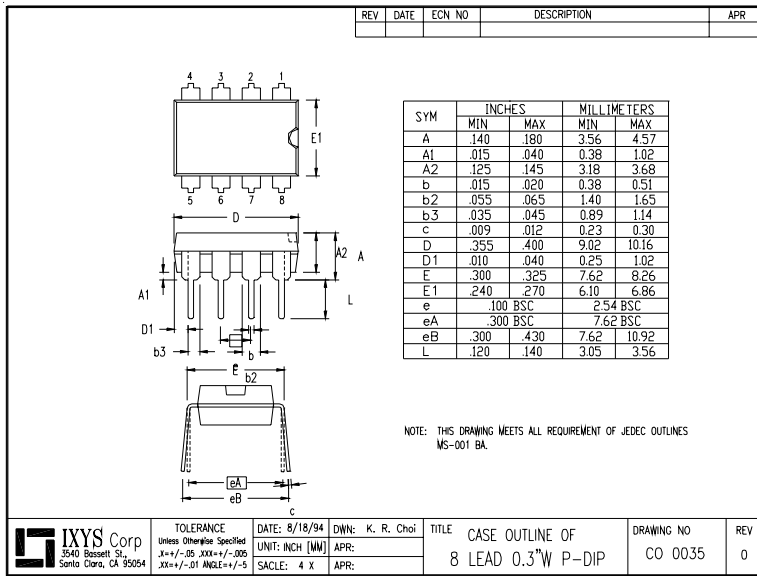

IXYS Corporation  
 3540 Bassett St; Santa Clara, CA 95054  
 Tel: 408-982-0700; Fax: 408-496-0670  
 e-mail: sales@ixys.net  
 www.ixys.com

IXYS Semiconductor GmbH  
 Edisonstrasse15 ; D-68623; Lampertheim  
 Tel: +49-6206-503-0; Fax: +49-6206-503627  
 e-mail: marcom@ixys.de

Directed Energy, Inc.  
 An IXYS Company  
 2401 Research Blvd. Ste. 108, Ft. Collins, CO 80526  
 Tel: 970-493-1901; Fax: 970-493-1903  
 e-mail: deiinfo@directedenergy.com  
 www.directedenergy.com





## Looking for pricing, stock, or lifecycle information?

Click below to explore more details on WIN SOURCE:

 [View IXDI402SIA on WIN SOURCE](#)

 [IXYS Information](#)

## Optimize Your Supply Chain with WIN SOURCE Solutions

-  Global Sourcing Solution
-  Obsolete Management
-  Cost Control Management
-  Shortage Management
-  Alternative Solution
-  Excess Inventory Management