



**THE DATASHEET OF
AD7606BSTZ-6RL**



FEATURES

- 8/6/4 simultaneously sampled inputs
- True bipolar analog input ranges: $\pm 10\text{ V}$, $\pm 5\text{ V}$
- Single 5 V analog supply and 2.3 V to 5 V V_{DRIVE}
- Fully integrated data acquisition solution
 - Analog input clamp protection
 - Input buffer with 1 M Ω analog input impedance
 - Second-order antialiasing analog filter
 - On-chip accurate reference and reference buffer
 - 16-bit ADC with 200 kSPS on all channels
 - Oversampling capability with digital filter
- Flexible parallel/serial interface
 - SPI/QSPI™/MICROWIRE™/DSP compatible
- Performance
 - 7 kV ESD rating on analog input channels
 - 95.5 dB SNR, -107 dB THD
 - $\pm 0.5\text{ LSB INL}$, $\pm 0.5\text{ LSB DNL}$
 - Low power: 100 mW
 - Standby mode: 25 mW
 - Temperature range: -40°C to $+85^{\circ}\text{C}$
 - 64-lead LQFP package

APPLICATIONS

- Power-line monitoring and protection systems
- Multiphase motor control
- Instrumentation and control systems
- Multiaxis positioning systems
- Data acquisition systems (DAS)

Table 1. High Resolution, Bipolar Input, Simultaneous Sampling DAS Solutions

Resolution	Single-Ended Inputs	True Differential Inputs	Number of Simultaneous Sampling Channels
18 Bits	AD7608	AD7609	8
16 Bits	AD7606		8
	AD7606-6		6
	AD7606-4		4
14 Bits	AD7607		8

FUNCTIONAL BLOCK DIAGRAM

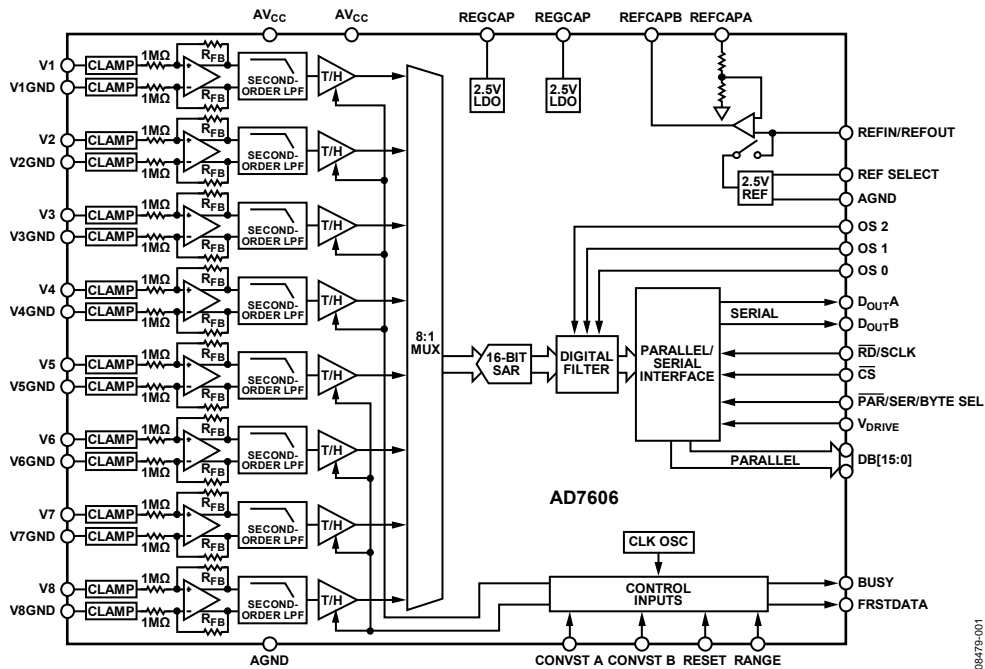

Figure 1.

Rev. E

[Document Feedback](#)

Information furnished by Analog Devices is believed to be accurate and reliable. However, no responsibility is assumed by Analog Devices for its use, nor for any infringements of patents or other rights of third parties that may result from its use. Specifications subject to change without notice. No license is granted by implication or otherwise under any patent or patent rights of Analog Devices. Trademarks and registered trademarks are the property of their respective owners.

TABLE OF CONTENTS

Features.....	1	Analog Input.....	22
Applications.....	1	ADC Transfer Function.....	23
Functional Block Diagram.....	1	Internal/External Reference.....	24
Revision History.....	2	Typical Connection Diagram.....	25
General Description.....	3	Power-Down Modes.....	25
Specifications.....	4	Conversion Control.....	26
Timing Specifications.....	7	Digital Interface.....	27
Absolute Maximum Ratings.....	11	Parallel Interface ($\overline{\text{PAR}}/\text{SER}/\text{BYTE SEL} = 0$).....	27
Thermal Resistance.....	11	Parallel Byte ($\overline{\text{PAR}}/\text{SER}/\text{BYTE SEL} = 1, \text{DB15} = 1$).....	27
ESD Caution.....	11	Serial Interface ($\overline{\text{PAR}}/\text{SER}/\text{BYTE SEL} = 1$).....	27
Pin Configurations and Function Descriptions.....	12	Reading During Conversion.....	28
Typical Performance Characteristics.....	17	Digital Filter.....	29
Terminology.....	21	Layout Guidelines.....	32
Theory of Operation.....	22	Outline Dimensions.....	34
Converter Details.....	22	Ordering Guide.....	34

REVISION HISTORY

5/2018—Rev. D to Rev. E

Changes to Patent Note, Note 1.....	3
Changes to t_{CONV} Parameter, Table 3.....	7

11/2017—Rev. C to Rev. D

Changes to Features Section.....	1
Changes to Specifications Table Summary.....	3
Deleted Endnote 1, Table 1; Renumbered Sequentially.....	6
Change to Table 6.....	14
Changes to Typical Performance Characteristics Section.....	17
Changes to Terminology Section.....	21
Changes to Ordering Guide.....	34

1/2012—Rev. B to Rev. C

Changes to Analog Input Ranges Section.....	22
---	----

10/2011—Rev. A to Rev. B

Changes to Input High Voltage (V_{INH}) and Input Low Voltage (V_{INL}) Parameters and Endnote 6, Table 2.....	4
Changes to Table 3.....	7
Changes to Table 4.....	11
Changes to Pin 32 Description, Table 6.....	13
Changes to Analog Input Clamp Protection Section.....	22
Changes to Typical Connection Diagram Section.....	25

8/2010—Rev. 0 to Rev. A

Changes to Note 1, Table 2.....	6
---------------------------------	---

5/2010—Revision 0: Initial Version

GENERAL DESCRIPTION

The AD7606¹/AD7606-6/AD7606-4 are 16-bit, simultaneous sampling, analog-to-digital data acquisition systems (DAS) with eight, six, and four channels, respectively. Each part contains analog input clamp protection, a second-order antialiasing filter, a track-and-hold amplifier, a 16-bit charge redistribution successive approximation analog-to-digital converter (ADC), a flexible digital filter, a 2.5 V reference and reference buffer, and high speed serial and parallel interfaces.

The AD7606/AD7606-6/AD7606-4 operate from a single 5 V supply and can accommodate ± 10 V and ± 5 V true bipolar input signals while sampling at throughput rates up to 200 kSPS for

all channels. The input clamp protection circuitry can tolerate voltages up to ± 16.5 V. The AD7606 has 1 M Ω analog input impedance regardless of sampling frequency. The single supply operation, on-chip filtering, and high input impedance eliminate the need for driver op amps and external bipolar supplies. The AD7606/AD7606-6/AD7606-4 antialiasing filter has a 3 dB cutoff frequency of 22 kHz and provides 40 dB antialias rejection when sampling at 200 kSPS. The flexible digital filter is pin driven, yields improvements in SNR, and reduces the 3 dB bandwidth.

¹ Protected by US Patent Number 8,072,360.

SPECIFICATIONS

$V_{REF} = 2.5\text{ V}$ external/internal, $AV_{CC} = 4.75\text{ V}$ to 5.25 V , $V_{DRIVE} = 2.3\text{ V}$ to 5.25 V , $f_{SAMPLE} = 200\text{ kSPS}$, $T_A = -40^\circ\text{C}$ to $+85^\circ\text{C}$, unless otherwise noted.

Table 2.

Parameter	Test Conditions/Comments	Min	Typ	Max	Unit
DYNAMIC PERFORMANCE					
Signal-to-Noise Ratio (SNR) ^{1,2}	$f_{IN} = 1\text{ kHz}$ sine wave unless otherwise noted				
	Oversampling by 16; $\pm 10\text{ V}$ range; $f_{IN} = 130\text{ Hz}$	94	95.5		dB
	Oversampling by 16; $\pm 5\text{ V}$ range; $f_{IN} = 130\text{ Hz}$	93	94.5		dB
	No oversampling; $\pm 10\text{ V}$ Range	88.5	90		dB
Signal-to-(Noise + Distortion) (SINAD) ¹	No oversampling; $\pm 5\text{ V}$ range	87.5	89		dB
	No oversampling; $\pm 10\text{ V}$ range	88	90		dB
Dynamic Range	No oversampling; $\pm 5\text{ V}$ range	87	89		dB
	No oversampling; $\pm 10\text{ V}$ range		90.5		dB
Total Harmonic Distortion (THD) ¹	No oversampling; $\pm 5\text{ V}$ range		90		dB
	No oversampling; $\pm 10\text{ V}$ range		90.5		dB
Peak Harmonic or Spurious Noise (SFDR) ¹			-107	-95	dB
Intermodulation Distortion (IMD) ¹	$f_a = 1\text{ kHz}$, $f_b = 1.1\text{ kHz}$		-108		dB
		Second-Order Terms		-110	
Third-Order Terms			-106		dB
Channel-to-Channel Isolation ¹	f_{IN} on unselected channels up to 160 kHz		-95		dB
ANALOG INPUT FILTER					
Full Power Bandwidth	-3 dB, $\pm 10\text{ V}$ range		23		kHz
	-3 dB, $\pm 5\text{ V}$ range		15		kHz
	-0.1 dB, $\pm 10\text{ V}$ range		10		kHz
	-0.1 dB, $\pm 5\text{ V}$ range		5		kHz
$t_{GROUP\ DELAY}$	$\pm 10\text{ V}$ Range		11		μs
	$\pm 5\text{ V}$ Range		15		μs
DC ACCURACY					
Resolution	No missing codes	16			Bits
Differential Nonlinearity ¹			± 0.5	± 0.99	LSB ³
Integral Nonlinearity ¹			± 0.5	± 2	LSB
Total Unadjusted Error (TUE)	$\pm 10\text{ V}$ range		± 6		LSB
	$\pm 5\text{ V}$ range		± 12		LSB
Positive Full-Scale Error ^{1,4}	External reference		± 8	± 32	LSB
	Internal reference		± 8		LSB
Positive Full-Scale Error Drift	External reference		± 2		ppm/ $^\circ\text{C}$
	Internal reference		± 7		ppm/ $^\circ\text{C}$
Positive Full-Scale Error Matching ¹	$\pm 10\text{ V}$ range		5	32	LSB
	$\pm 5\text{ V}$ range		16	40	LSB
Bipolar Zero Code Error ^{1,5}	$\pm 10\text{ V}$ range		± 1	± 6	LSB
	$\pm 5\text{ V}$ range		± 3	± 12	LSB
Bipolar Zero Code Error Drift	$\pm 10\text{ V}$ range		10		$\mu\text{V}/^\circ\text{C}$
	$\pm 5\text{ V}$ range		5		$\mu\text{V}/^\circ\text{C}$
Bipolar Zero Code Error Matching ¹	$\pm 10\text{ V}$ range		1	8	LSB
	$\pm 5\text{ V}$ range		6	22	LSB
Negative Full-Scale Error ^{1,4}	External reference		± 8	± 32	LSB
	Internal reference		± 8		LSB
Negative Full-Scale Error Drift	External reference		± 4		ppm/ $^\circ\text{C}$
	Internal reference		± 8		ppm/ $^\circ\text{C}$
Negative Full-Scale Error Matching ¹	$\pm 10\text{ V}$ range		5	32	LSB
	$\pm 5\text{ V}$ range		16	40	LSB

Parameter	Test Conditions/Comments	Min	Typ	Max	Unit
ANALOG INPUT					
Input Voltage Ranges	RANGE = 1			±10	V
	RANGE = 0			±5	V
Analog Input Current	10 V; see Figure 31		5.4		μA
	5 V; see Figure 31		2.5		μA
Input Capacitance ⁶			5		pF
Input Impedance	See the Analog Input section		1		MΩ
REFERENCE INPUT/OUTPUT					
Reference Input Voltage Range	See the ADC Transfer Function section	2.475	2.5	2.525	V
DC Leakage Current				±1	μA
Input Capacitance ⁶	REF SELECT = 1		7.5		pF
Reference Output Voltage	REFIN/REFOUT		2.49/ 2.505		V
Reference Temperature Coefficient			±10		ppm/°C
LOGIC INPUTS					
Input High Voltage (V_{INH})		$0.7 \times V_{DRIVE}$			V
Input Low Voltage (V_{INL})				$0.3 \times V_{DRIVE}$	V
Input Current (I_{IN})				±2	μA
Input Capacitance (C_{IN}) ⁶			5		pF
LOGIC OUTPUTS					
Output High Voltage (V_{OH})	$I_{SOURCE} = 100 \mu A$	$V_{DRIVE} - 0.2$			V
Output Low Voltage (V_{OL})	$I_{SINK} = 100 \mu A$			0.2	V
Floating-State Leakage Current			±1	±20	μA
Floating-State Output Capacitance ⁶			5		pF
Output Coding	Twos complement				
CONVERSION RATE					
Conversion Time	All eight channels included; see Table 3		4		μs
Track-and-Hold Acquisition Time			1		μs
Throughput Rate	Per channel, all eight channels included			200	kSPS
POWER REQUIREMENTS					
A_{VCC}		4.75		5.25	V
V_{DRIVE}		2.3		5.25	V
I_{TOTAL}	Digital inputs = 0V or V_{DRIVE}				
Normal Mode (Static)	AD7606		16	22	mA
	AD7606-6		14	20	mA
	AD7606-4		12	17	mA
Normal Mode (Operational) ⁷	$f_{SAMPLE} = 200$ kSPS				
	AD7606		20	27	mA
	AD7606-6		18	24	mA
	AD7606-4		15	21	mA
Standby Mode			5	8	mA
Shutdown Mode			2	6	μA

Parameter	Test Conditions/Comments	Min	Typ	Max	Unit
Power Dissipation					
Normal Mode (Static)	AD7606		80	115.5	mW
Normal Mode (Operational) ⁷	$f_{\text{SAMPLE}} = 200 \text{ kSPS}$				
	AD7606		100	142	mW
	AD7606-6		90	126	mW
	AD7606-4		75	111	mW
Standby Mode			25	42	mW
Shutdown Mode			10	31.5	μW

¹See the Terminology section.

²This specification applies when reading during a conversion or after a conversion. If reading during a conversion in parallel mode with $V_{\text{DRIVE}} = 5 \text{ V}$, SNR typically reduces by 1.5 dB and THD by 3 dB.

³LSB means least significant bit. With $\pm 5 \text{ V}$ input range, 1 LSB = 152.58 μV . With $\pm 10 \text{ V}$ input range, 1 LSB = 305.175 μV .

⁴These specifications include the full temperature range variation and contribution from the internal reference buffer but do not include the error contribution from the external reference.

⁵Bipolar zero code error is calculated with respect to the analog input voltage. See the Analog Input Clamp Protection section.

⁶Sample tested during initial release to ensure compliance.

⁷Operational power/current figure includes contribution when running in oversampling mode.

TIMING SPECIFICATIONS

$V_{CC} = 4.75\text{ V to } 5.25\text{ V}$, $V_{DRIVE} = 2.3\text{ V to } 5.25\text{ V}$, $V_{REF} = 2.5\text{ V}$ external reference/internal reference, $T_A = T_{MIN}$ to T_{MAX} , unless otherwise noted.¹

Table 3.

Parameter	Limit at T_{MIN} , T_{MAX} ($0.1 \times V_{DRIVE}$ and $0.9 \times V_{DRIVE}$ Logic Input Levels)			Limit at T_{MIN} , T_{MAX} ($0.3 \times V_{DRIVE}$ and $0.7 \times V_{DRIVE}$ Logic Input Levels)			Unit	Description
	Min	Typ	Max	Min	Typ	Max		
PARALLEL/SERIAL/BYTE MODE								
t_{CYCLE}			5			5	μs	1/throughput rate
						9.4	μs	Parallel mode, reading during or after conversion; or serial mode: $V_{DRIVE} = 3.3\text{ V to } 5.25\text{ V}$, reading during a conversion using D_{OUTA} and D_{OUTB} lines
			9.7			10.7	μs	Serial mode reading after a conversion; $V_{DRIVE} = 2.7\text{ V}$
							μs	Serial mode reading after a conversion; $V_{DRIVE} = 2.3\text{ V}$, D_{OUTA} and D_{OUTB} lines
t_{CONV^2}								Conversion time
	3.45	4	4.2	3.45	4	4.2	μs	Oversampling off; AD7606
		3			3		μs	Oversampling off; AD7606-6
		2			2		μs	Oversampling off; AD7606-4
	7.87		9.1	7.87		9.1	μs	Oversampling by 2; AD7606
	16.05		18.8	16.05		18.8	μs	Oversampling by 4; AD7606
	33		39	33		39	μs	Oversampling by 8; AD7606
	66		78	66		78	μs	Oversampling by 16; AD7606
	133		158	133		158	μs	Oversampling by 32; AD7606
	257		315	257		315	μs	Oversampling by 64; AD7606
$t_{WAKE-UP\ STANDBY}$			100			100	μs	\overline{STBY} rising edge to $CONVST$ x rising edge; power-up time from standby mode
$t_{WAKE-UP\ SHUTDOWN}$								
Internal Reference			30			30	ms	\overline{STBY} rising edge to $CONVST$ x rising edge; power-up time from shutdown mode
External Reference			13			13	ms	\overline{STBY} rising edge to $CONVST$ x rising edge; power-up time from shutdown mode
t_{RESET}	50			50			ns	RESET high pulse width
t_{OS_SETUP}	20			20			ns	BUSY to OS x pin setup time
t_{OS_HOLD}	20			20			ns	BUSY to OS x pin hold time
t_1			40			45	ns	$CONVST$ x high to BUSY high
t_2	25			25			ns	Minimum $CONVST$ x low pulse
t_3	25			25			ns	Minimum $CONVST$ x high pulse
t_4	0			0			ns	BUSY falling edge to \overline{CS} falling edge setup time
t_5^3			0.5			0.5	ms	Maximum delay allowed between $CONVST$ A, $CONVST$ B rising edges
t_6			25			25	ns	Maximum time between last \overline{CS} rising edge and BUSY falling edge
t_7	25			25			ns	Minimum delay between RESET low to $CONVST$ x high
PARALLEL/BYTE READ OPERATION								
t_8	0			0			ns	\overline{CS} to \overline{RD} setup time
t_9	0			0			ns	\overline{CS} to \overline{RD} hold time
t_{10}								\overline{RD} low pulse width
	16			19			ns	V_{DRIVE} above 4.75 V
	21			24			ns	V_{DRIVE} above 3.3 V
	25			30			ns	V_{DRIVE} above 2.7 V
	32			37			ns	V_{DRIVE} above 2.3 V
t_{11}	15			15			ns	\overline{RD} high pulse width
t_{12}	22			22			ns	\overline{CS} high pulse width (see Figure 5); \overline{CS} and \overline{RD} linked

Parameter	Limit at T_{MIN} , T_{MAX} ($0.1 \times V_{DRIVE}$ and $0.9 \times V_{DRIVE}$ Logic Input Levels)			Limit at T_{MIN} , T_{MAX} ($0.3 \times V_{DRIVE}$ and $0.7 \times V_{DRIVE}$ Logic Input Levels)			Unit	Description
	Min	Typ	Max	Min	Typ	Max		
t_{13}			16			19	ns	Delay from \overline{CS} until DB[15:0] three-state disabled V_{DRIVE} above 4.75 V
			20			24	ns	V_{DRIVE} above 3.3 V
			25			30	ns	V_{DRIVE} above 2.7 V
			30			37	ns	V_{DRIVE} above 2.3 V
t_{14}^4								Data access time after \overline{RD} falling edge
			16			19	ns	V_{DRIVE} above 4.75 V
			21			24	ns	V_{DRIVE} above 3.3 V
			25			30	ns	V_{DRIVE} above 2.7 V
			32			37	ns	V_{DRIVE} above 2.3 V
t_{15}	6			6			ns	Data hold time after \overline{RD} falling edge
t_{16}	6			6			ns	\overline{CS} to DB[15:0] hold time
t_{17}			22			22	ns	Delay from \overline{CS} rising edge to DB[15:0] three-state enabled
SERIAL READ OPERATION								
f_{SCLK}			23.5			20	MHz	Frequency of serial read clock V_{DRIVE} above 4.75 V
			17			15	MHz	V_{DRIVE} above 3.3 V
			14.5			12.5	MHz	V_{DRIVE} above 2.7 V
			11.5			10	MHz	V_{DRIVE} above 2.3 V
t_{18}								Delay from \overline{CS} until $\overline{D_{OUTA}}/\overline{D_{OUTB}}$ three-state disabled/delay from \overline{CS} until MSB valid
			15			18	ns	V_{DRIVE} above 4.75 V
			20			23	ns	V_{DRIVE} above 3.3 V
			30			35	ns	$V_{DRIVE} = 2.3 \text{ V to } 2.7 \text{ V}$
t_{19}^4								Data access time after SCLK rising edge
			17			20	ns	V_{DRIVE} above 4.75 V
			23			26	ns	V_{DRIVE} above 3.3 V
			27			32	ns	V_{DRIVE} above 2.7 V
			34			39	ns	V_{DRIVE} above 2.3 V
t_{20}	$0.4 t_{SCLK}$			$0.4 t_{SCLK}$			ns	SCLK low pulse width
t_{21}	$0.4 t_{SCLK}$			$0.4 t_{SCLK}$			ns	SCLK high pulse width
t_{22}	7			7			ns	SCLK rising edge to $\overline{D_{OUTA}}/\overline{D_{OUTB}}$ valid hold time
t_{23}			22			22	ns	\overline{CS} rising edge to $\overline{D_{OUTA}}/\overline{D_{OUTB}}$ three-state enabled
FRSTDATA OPERATION								
t_{24}								Delay from \overline{CS} falling edge until FRSTDATA three-state disabled
			15			18	ns	V_{DRIVE} above 4.75 V
			20			23	ns	V_{DRIVE} above 3.3 V
			25			30	ns	V_{DRIVE} above 2.7 V
			30			35	ns	V_{DRIVE} above 2.3 V
t_{25}							ns	Delay from \overline{CS} falling edge until FRSTDATA high, serial mode
			15			18	ns	V_{DRIVE} above 4.75 V
			20			23	ns	V_{DRIVE} above 3.3 V
			25			30	ns	V_{DRIVE} above 2.7 V
			30			35	ns	V_{DRIVE} above 2.3 V
t_{26}								Delay from \overline{RD} falling edge to FRSTDATA high
			16			19	ns	V_{DRIVE} above 4.75 V
			20			23	ns	V_{DRIVE} above 3.3 V
			25			30	ns	V_{DRIVE} above 2.7 V
			30			35	ns	V_{DRIVE} above 2.3 V

Parameter	Limit at T_{MIN} , T_{MAX} ($0.1 \times V_{DRIVE}$ and $0.9 \times V_{DRIVE}$ Logic Input Levels)			Limit at T_{MIN} , T_{MAX} ($0.3 \times V_{DRIVE}$ and $0.7 \times V_{DRIVE}$ Logic Input Levels)			Unit	Description
	Min	Typ	Max	Min	Typ	Max		
t_{27}			19			22	ns	Delay from \overline{RD} falling edge to FRSTDATA low $V_{DRIVE} = 3.3\text{ V to }5.25\text{ V}$
t_{28}			24			29	ns	$V_{DRIVE} = 2.3\text{ V to }2.7\text{ V}$
			17			20	ns	Delay from 16 th SCLK falling edge to FRSTDATA low $V_{DRIVE} = 3.3\text{ V to }5.25\text{ V}$
t_{29}			22			27	ns	$V_{DRIVE} = 2.3\text{ V to }2.7\text{ V}$
			24			29	ns	Delay from \overline{CS} rising edge until FRSTDATA three-state enabled

¹ Sample tested during initial release to ensure compliance. All input signals are specified with $t_r = t_f = 5\text{ ns}$ (10% to 90% of V_{DRIVE}) and timed from a voltage level of 1.6 V.
² In oversampling mode, typical t_{CONV} for the AD7606-6 and AD7606-4 can be calculated using $((N \times t_{CONV}) + ((N - 1) \times 1\ \mu\text{s}))$. N is the oversampling ratio. For the AD7606-6, $t_{CONV} = 3\ \mu\text{s}$; and for the AD7606-4, $t_{CONV} = 2\ \mu\text{s}$.
³ The delay between the CONVST x signals was measured as the maximum time allowed while ensuring a <10 LSB performance matching between channel sets.
⁴ A buffer is used on the data output pins for these measurements, which is equivalent to a load of 20 pF on the output pins.

Timing Diagrams

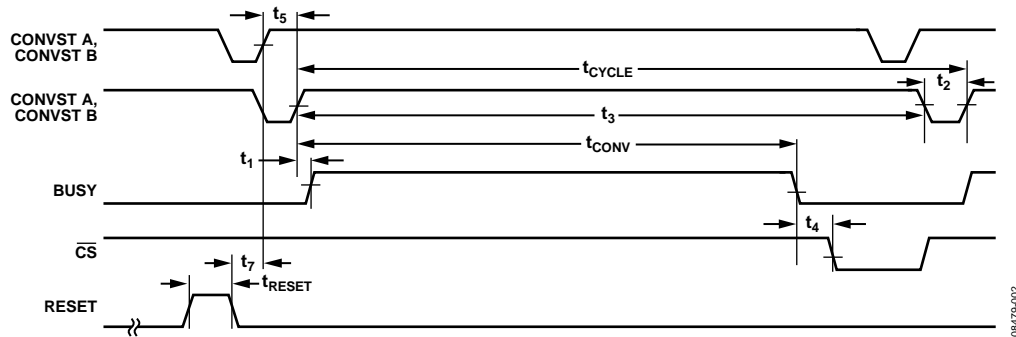

Figure 2. CONVST Timing—Reading After a Conversion

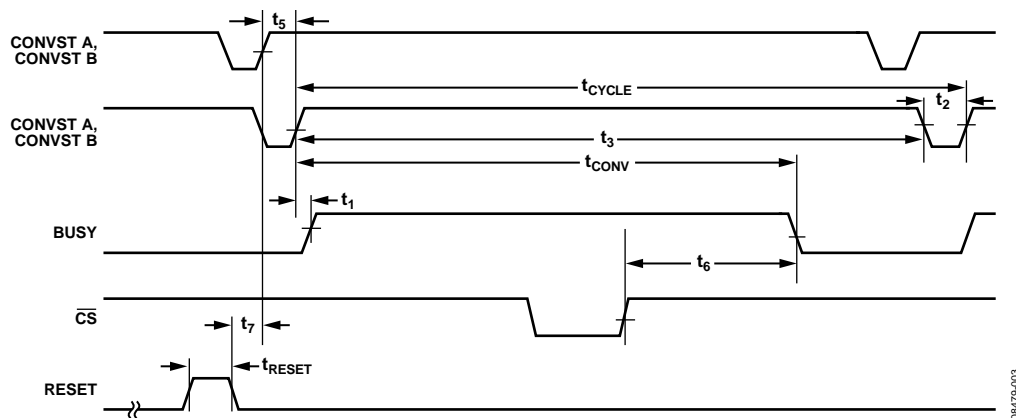

Figure 3. CONVST Timing—Reading During a Conversion

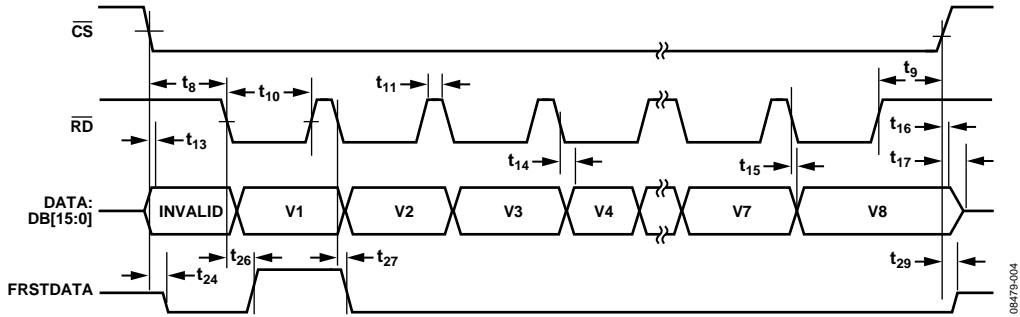

Figure 4. Parallel Mode, Separate \overline{CS} and \overline{RD} Pulses

08479-004

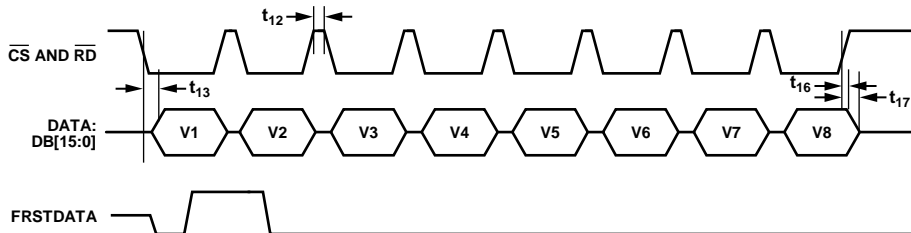

Figure 5. \overline{CS} and \overline{RD} , Linked Parallel Mode

08479-005

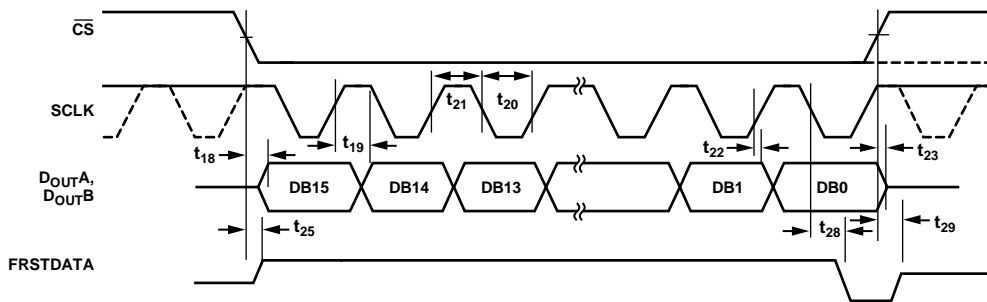

Figure 6. Serial Read Operation (Channel 1)

08479-006

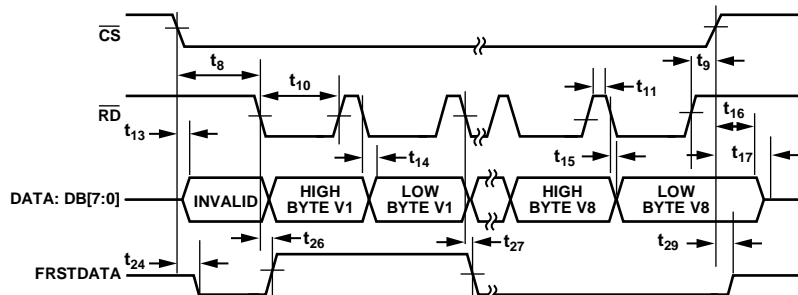

Figure 7. BYTE Mode Read Operation

08479-007

ABSOLUTE MAXIMUM RATINGS

$T_A = 25^\circ\text{C}$, unless otherwise noted.

Table 4.

Parameter	Rating
AV_{CC} to AGND	-0.3 V to +7 V
V_{DRIVE} to AGND	-0.3 V to $AV_{CC} + 0.3$ V
Analog Input Voltage to AGND ¹	± 16.5 V
Digital Input Voltage to AGND	-0.3 V to $V_{DRIVE} + 0.3$ V
Digital Output Voltage to AGND	-0.3 V to $V_{DRIVE} + 0.3$ V
REFIN to AGND	-0.3 V to $AV_{CC} + 0.3$ V
Input Current to Any Pin Except Supplies ¹	± 10 mA
Operating Temperature Range	
B Version	-40°C to $+85^\circ\text{C}$
Storage Temperature Range	-65°C to $+150^\circ\text{C}$
Junction Temperature	150°C
Pb/SN Temperature, Soldering	
Reflow (10 sec to 30 sec)	$240 (+0)^\circ\text{C}$
Pb-Free Temperature, Soldering Reflow	$260 (+0)^\circ\text{C}$
ESD (All Pins Except Analog Inputs)	2 kV
ESD (Analog Input Pins Only)	7 kV

¹ Transient currents of up to 100 mA do not cause SCR latch-up.

Stresses at or above those listed under Absolute Maximum Ratings may cause permanent damage to the product. This is a stress rating only; functional operation of the product at these or any other conditions above those indicated in the operational section of this specification is not implied. Operation beyond the maximum operating conditions for extended periods may affect product reliability.

THERMAL RESISTANCE

θ_{JA} is specified for the worst-case conditions, that is, a device soldered in a circuit board for surface-mount packages. These specifications apply to a 4-layer board.

Table 5. Thermal Resistance

Package Type	θ_{JA}	θ_{JC}	Unit
64-Lead LQFP	45	11	$^\circ\text{C}/\text{W}$

ESD CAUTION



ESD (electrostatic discharge) sensitive device. Charged devices and circuit boards can discharge without detection. Although this product features patented or proprietary protection circuitry, damage may occur on devices subjected to high energy ESD. Therefore, proper ESD precautions should be taken to avoid performance degradation or loss of functionality.

PIN CONFIGURATIONS AND FUNCTION DESCRIPTIONS

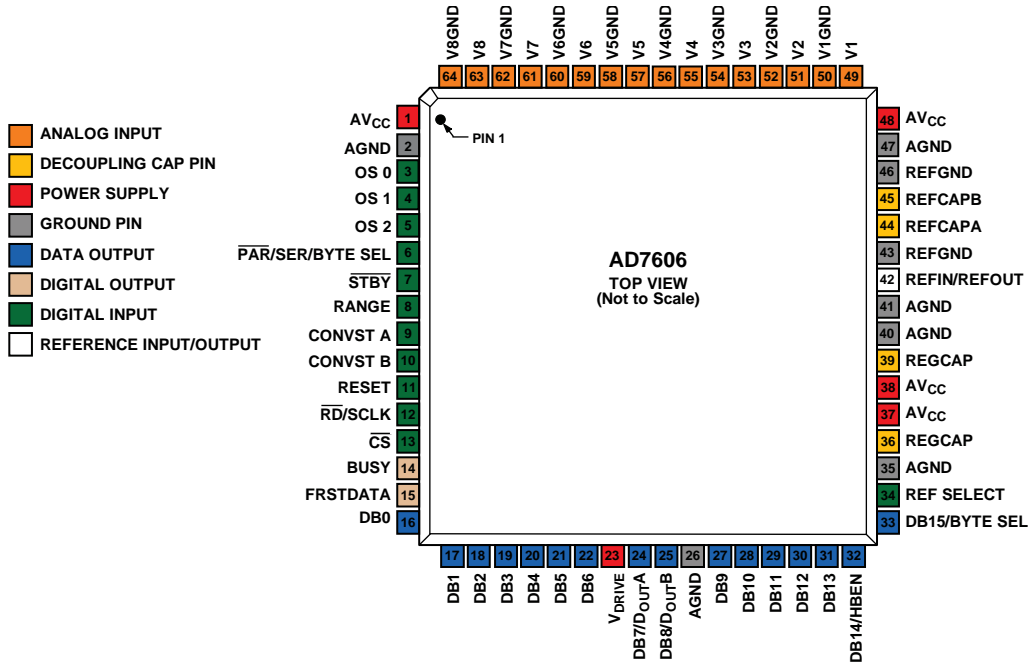

Figure 8. AD7606 Pin Configuration

08479-008

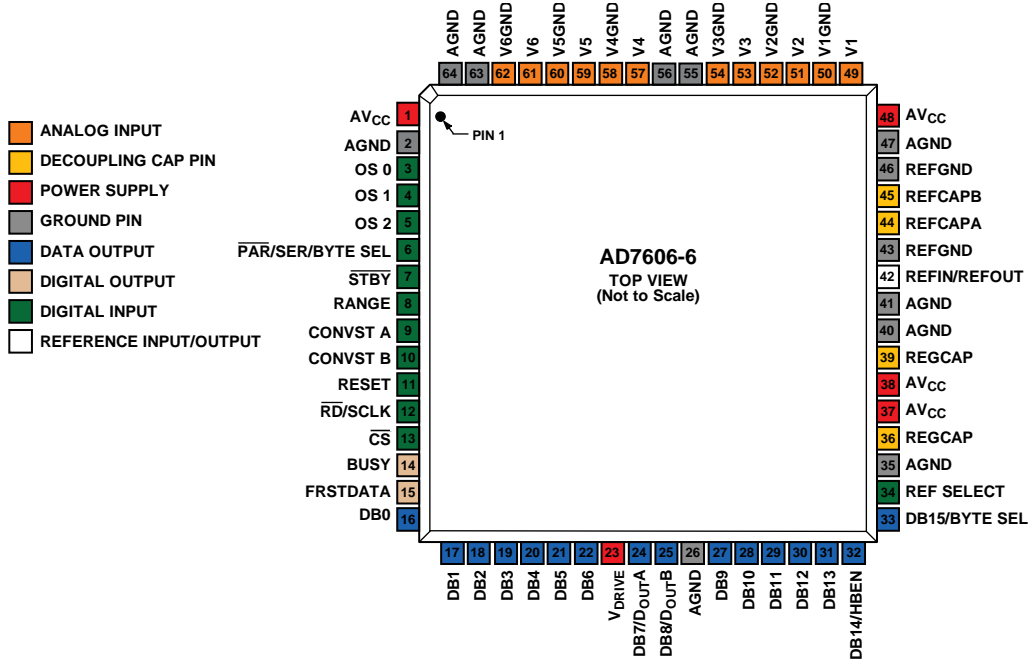

Figure 9. AD7606-6 Pin Configuration

08479-009

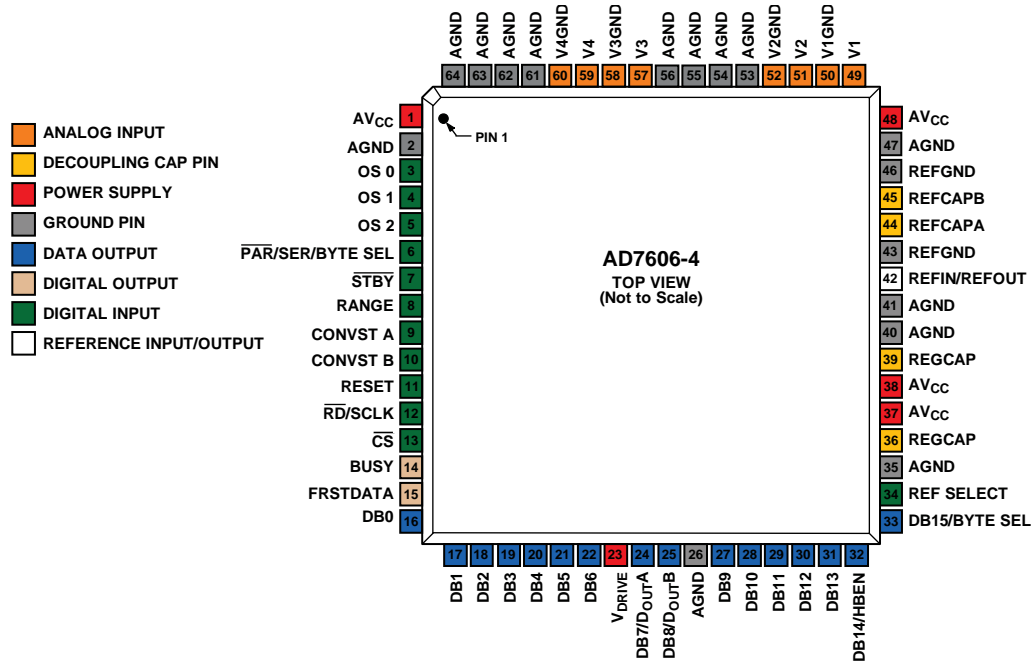

Figure 10. AD7606-4 Pin Configuration

08479-010

Table 6. Pin Function Descriptions

Pin No.	Type ¹	Mnemonic			Description
		AD7606	AD7606-6	AD7606-4	
1, 37, 38, 48	P	AV _{CC}	AV _{CC}	AV _{CC}	Analog Supply Voltage, 4.75 V to 5.25 V. This supply voltage is applied to the internal front-end amplifiers and to the ADC core. These supply pins should be decoupled to AGND.
2, 26, 35, 40, 41, 47	P	AGND	AGND	AGND	Analog Ground. These pins are the ground reference points for all analog circuitry on the AD7606. All analog input signals and external reference signals should be referred to these pins. All six of these AGND pins should connect to the AGND plane of a system.
5, 4, 3	DI	OS [2:0]	OS [2:0]	OS [2:0]	Oversampling Mode Pins. Logic inputs. These inputs are used to select the oversampling ratio. OS 2 is the MSB control bit, and OS 0 is the LSB control bit. See the Digital Filter section for more details about the oversampling mode of operation and Table 9 for oversampling bit decoding.
6	DI	$\overline{\text{PAR/SER/}}\text{BYTE SEL}$	$\overline{\text{PAR/SER/}}\text{BYTE SEL}$	$\overline{\text{PAR/SER/}}\text{BYTE SEL}$	Parallel/Serial/Byte Interface Selection Input. Logic input. If this pin is tied to a logic low, the parallel interface is selected. If this pin is tied to a logic high, the serial interface is selected. Parallel byte interface mode is selected when this pin is logic high and DB15/BYTE SEL is logic high (see Table 8). In serial mode, the $\overline{\text{RD/SCLK}}$ pin functions as the serial clock input. The DB7/D _{OUT} A pin and the DB8/D _{OUT} B pin function as serial data outputs. When the serial interface is selected, the DB[15:9] and DB[6:0] pins should be tied to ground. In byte mode, DB15, in conjunction with $\overline{\text{PAR/SER/}}\text{BYTE SEL}$, is used to select the parallel byte mode of operation (see Table 8). DB14 is used as the HBEN pin. DB[7:0] transfer the 16-bit conversion results in two $\overline{\text{RD}}$ operations, with DB0 as the LSB of the data transfers.
7	DI	$\overline{\text{STBY}}$	$\overline{\text{STBY}}$	$\overline{\text{STBY}}$	Standby Mode Input. This pin is used to place the AD7606/AD7606-6/AD7606-4 into one of two power-down modes: standby mode or shutdown mode. The power-down mode entered depends on the state of the RANGE pin, as shown in Table 7. When in standby mode, all circuitry, except the on-chip reference, regulators, and regulator buffers, is powered down. When in shutdown mode, all circuitry is powered down.

Pin No.	Type ¹	Mnemonic			Description
		AD7606	AD7606-6	AD7606-4	
8	DI	RANGE	RANGE	RANGE	Analog Input Range Selection. Logic input. The polarity on this pin determines the input range of the analog input channels. If this pin is tied to a logic high, the analog input range is $\pm 10V$ for all channels. If this pin is tied to a logic low, the analog input range is $\pm 5V$ for all channels. A logic change on this pin has an immediate effect on the analog input range. Changing this pin during a conversion is not recommended for fast throughput rate applications. See the Analog Input section for more information.
9, 10	DI	CONVST A, CONVST B	CONVST A, CONVST B	CONVST A, CONVST B	Conversion Start Input A, Conversion Start Input B. Logic inputs. These logic inputs are used to initiate conversions on the analog input channels. For simultaneous sampling of all input channels, CONVST A and CONVST B can be shorted together, and a single convert start signal can be applied. Alternatively, CONVST A can be used to initiate simultaneous sampling: V1, V2, V3, and V4 for the AD7606; V1, V2, and V3 for the AD7606-6; and V1 and V2 for the AD7606-4. CONVST B can be used to initiate simultaneous sampling on the other analog inputs: V5, V6, V7, and V8 for the AD7606; V4, V5, and V6 for the AD7606-6; and V3 and V4 for the AD7606-4. This is possible only when oversampling is not switched on. When the CONVST A or CONVST B pin transitions from low to high, the front-end track-and-hold circuitry for the respective analog inputs is set to hold.
11	DI	RESET	RESET	RESET	Reset Input. When set to logic high, the rising edge of RESET resets the AD7606/AD7606-6/AD7606-4. The device should receive a RESET pulse directly after power-up. The RESET high pulse should typically be 50 ns wide. If a RESET pulse is applied during a conversion, the conversion is aborted. If a RESET pulse is applied during a read, the contents of the output registers reset to all zeros.
12	DI	$\overline{RD}/SCLK$	$\overline{RD}/SCLK$	$\overline{RD}/SCLK$	Parallel Data Read Control Input When the Parallel Interface Is Selected (\overline{RD})/ Serial Clock Input When the Serial Interface Is Selected (SCLK). When both \overline{CS} and \overline{RD} are logic low in parallel mode, the output bus is enabled. In serial mode, this pin acts as the serial clock input for data transfers. The \overline{CS} falling edge takes the D_{OUTA} and D_{OUTB} data output lines out of three-state and clocks out the MSB of the conversion result. The rising edge of SCLK clocks all subsequent data bits onto the D_{OUTA} and D_{OUTB} serial data outputs. For more information, see the Conversion Control section.
13	DI	\overline{CS}	\overline{CS}	\overline{CS}	Chip Select. This active low logic input frames the data transfer. When both \overline{CS} and \overline{RD} are logic low in parallel mode, the $DB[15:0]$ output bus is enabled and the conversion result is output on the parallel data bus lines. In serial mode, \overline{CS} is used to frame the serial read transfer and clock out the MSB of the serial output data.
14	DO	BUSY	BUSY	BUSY	Busy Output. This pin transitions to a logic high after both CONVST A and CONVST B rising edges and indicates that the conversion process has started. The BUSY output remains high until the conversion process for all channels is complete. The falling edge of BUSY signals that the conversion data is being latched into the output data registers and is available to read after a Time t_4 . Any data read while BUSY is high must be completed before the falling edge of BUSY occurs. Rising edges on CONVST A or CONVST B have no effect while the BUSY signal is high.
15	DO	FRSTDATA	FRSTDATA	FRSTDATA	Digital Output. The FRSTDATA output signal indicates when the first channel, V1, is being read back on the parallel, byte, or serial interface. When the \overline{CS} input is high, the FRSTDATA output pin is in three-state. The falling edge of \overline{CS} takes FRSTDATA out of three-state. In parallel mode, the falling edge of \overline{RD} corresponding to the result of V1 then sets the FRSTDATA pin high, indicating that the result from V1 is available on the output data bus. The FRSTDATA output returns to a logic low following the next falling edge of \overline{RD} . In serial mode, FRSTDATA goes high on the falling edge of \overline{CS} because this clocks out the MSB of V1 on D_{OUTA} . It returns low on the 16 th SCLK falling edge after the \overline{CS} falling edge. See the Conversion Control section for more details.

Pin No.	Type ¹	Mnemonic			Description
		AD7606	AD7606-6	AD7606-4	
22 to 16	DO	DB[6:0]	DB[6:0]	DB[6:0]	Parallel Output Data Bits, DB6 to DB0. When $\overline{\text{PAR/SER/BYTE SEL}} = 0$, these pins act as three-state parallel digital input/output pins. When $\overline{\text{CS}}$ and $\overline{\text{RD}}$ are low, these pins are used to output DB6 to DB0 of the conversion result. When $\overline{\text{PAR/SER/BYTE SEL}} = 1$, these pins should be tied to AGND. When operating in parallel byte interface mode, DB[7:0] outputs the 16-bit conversion result in two $\overline{\text{RD}}$ operations. DB7 (Pin 24) is the MSB; DB0 is the LSB.
23	P	V _{DRIVE}	V _{DRIVE}	V _{DRIVE}	Logic Power Supply Input. The voltage (2.3 V to 5.25 V) supplied at this pin determines the operating voltage of the interface. This pin is nominally at the same supply as the supply of the host interface (that is, DSP and FPGA).
24	DO	DB7/D _{OUTA}	DB7/D _{OUTA}	DB7/D _{OUTA}	Parallel Output Data Bit 7 (DB7)/Serial Interface Data Output Pin (D _{OUTA}). When $\overline{\text{PAR/SER/BYTE SEL}} = 0$, this pin acts as a three-state parallel digital input/output pin. When $\overline{\text{CS}}$ and $\overline{\text{RD}}$ are low, this pin is used to output DB7 of the conversion result. When $\overline{\text{PAR/SER/BYTE SEL}} = 1$, this pin functions as D _{OUTA} and outputs serial conversion data (see the Conversion Control section for more details). When operating in parallel byte mode, DB7 is the MSB of the byte.
25	DO	DB8/D _{OUTB}	DB8/D _{OUTB}	DB8/D _{OUTB}	Parallel Output Data Bit 8 (DB8)/Serial Interface Data Output Pin (D _{OUTB}). When $\overline{\text{PAR/SER/BYTE SEL}} = 0$, this pin acts as a three-state parallel digital input/output pin. When $\overline{\text{CS}}$ and $\overline{\text{RD}}$ are low, this pin is used to output DB8 of the conversion result. When $\overline{\text{PAR/SER/BYTE SEL}} = 1$, this pin functions as D _{OUTB} and outputs serial conversion data (see the Conversion Control section for more details).
31 to 27	DO	DB[13:9]	DB[13:9]	DB[13:9]	Parallel Output Data Bits, DB13 to DB9. When $\overline{\text{PAR/SER/BYTE SEL}} = 0$, these pins act as three-state parallel digital input/output pins. When $\overline{\text{CS}}$ and $\overline{\text{RD}}$ are low, these pins are used to output DB13 to DB9 of the conversion result. When $\overline{\text{PAR/SER/BYTE SEL}} = 1$, these pins should be tied to AGND.
32	DO/DI	DB14/HBEN	DB14/HBEN	DB14/HBEN	Parallel Output Data Bit 14 (DB14)/High Byte Enable (HBEN). When $\overline{\text{PAR/SER/BYTE SEL}} = 0$, this pin acts as a three-state parallel digital output pin. When $\overline{\text{CS}}$ and $\overline{\text{RD}}$ are low, this pin is used to output DB14 of the conversion result. When $\overline{\text{PAR/SER/BYTE SEL}} = 1$ and DB15/BYTE SEL = 1, the AD7606/AD7606-6/AD7606-4 operate in parallel byte interface mode. In parallel byte mode, the HBEN pin is used to select whether the most significant byte (MSB) or the least significant byte (LSB) of the conversion result is output first. When HBEN = 1, the MSB is output first, followed by the LSB. When HBEN = 0, the LSB is output first, followed by the MSB. In serial mode, this pin should be tied to GND.
33	DO/DI	DB15/BYTE SEL	DB15/BYTE SEL	DB15/BYTE SEL	Parallel Output Data Bit 15 (DB15)/Parallel Byte Mode Select (BYTE SEL). When $\overline{\text{PAR/SER/BYTE SEL}} = 0$, this pin acts as a three-state parallel digital output pin. When $\overline{\text{CS}}$ and $\overline{\text{RD}}$ are low, this pin is used to output DB15 of the conversion result. When $\overline{\text{PAR/SER/BYTE SEL}} = 1$, the BYTE SEL pin is used to select between serial interface mode and parallel byte interface mode (see Table 8). When $\overline{\text{PAR/SER/BYTE SEL}} = 1$ and DB15/BYTE SEL = 0, the AD7606 operates in serial interface mode. When $\overline{\text{PAR/SER/BYTE SEL}} = 1$ and DB15/BYTE SEL = 1, the AD7606 operates in parallel byte interface mode.
34	DI	REF SELECT	REF SELECT	REF SELECT	Internal/External Reference Selection Input. Logic input. If this pin is set to logic high, the internal reference is selected and enabled. If this pin is set to logic low, the internal reference is disabled and an external reference voltage must be applied to the REFIN/REFOUT pin.
36, 39	P	REGCAP	REGCAP	REGCAP	Decoupling Capacitor Pin for Voltage Output from Internal Regulator. These output pins should be decoupled separately to AGND using a 1 μF capacitor. The voltage on these pins is in the range of 2.5 V to 2.7 V.

Pin No.	Type ¹	Mnemonic			Description
		AD7606	AD7606-6	AD7606-4	
42	REF	REFIN/ REFOUT	REFIN/ REFOUT	REFIN/ REFOUT	Reference Input (REFIN)/Reference Output (REFOUT). The on-chip reference of 2.5 V is available on this pin for external use if the REF SELECT pin is set to logic high. Alternatively, the internal reference can be disabled by setting the REF SELECT pin to logic low, and an external reference of 2.5 V can be applied to this input (see the Internal/External Reference section). Decoupling is required on this pin for both the internal and external reference options. A 10 μ F capacitor should be applied from this pin to ground close to the REFGND pins.
43, 46	REF	REFGND	REFGND	REFGND	Reference Ground Pins. These pins should be connected to AGND.
44, 45	REF	REFCAPA, REFCAPB	REFCAPA, REFCAPB	REFCAPA, REFCAPB	Reference Buffer Output Force/Sense Pins. These pins must be connected together and decoupled to AGND using a low ESR, 10 μ F ceramic capacitor. The voltage on these pins is typically 4.5 V.
49	AI	V1	V1	V1	Analog Input. This pin is a single-ended analog input. The analog input range of this channel is determined by the RANGE pin.
50, 52	AI GND	V1GND, V2GND	V1GND, V2GND	V1GND, V2GND	Analog Input Ground Pins. These pins correspond to Analog Input Pin V1 and Analog Input Pin V2. All analog input AGND pins should connect to the AGND plane of a system.
51	AI	V2	V2	V2	Analog Input. This pin is a single-ended analog input. The analog input range of this channel is determined by the RANGE pin.
53	AI/GND	V3	V3	AGND	Analog Input 3. For the AD7606-4, this is an AGND pin.
54	AI GND/ GND	V3GND	V3GND	AGND	Analog Input Ground Pin. For the AD7606-4, this is an AGND pin.
55	AI/GND	V4	AGND	AGND	Analog Input 4. For the AD7606-6 and the AD7606-4, this is an AGND pin.
56	AI GND/ GND	V4GND	AGND	AGND	Analog Input Ground Pin. For the AD7606-6 and AD7606-4, this is an AGND pin.
57	AI	V5	V4	V3	Analog Inputs. These pins are single-ended analog inputs. The analog input range of these channels is determined by the RANGE pin.
58	AI GND	V5GND	V4GND	V3GND	Analog Input Ground Pins. All analog input AGND pins should connect to the AGND plane of a system.
59	AI	V6	V5	V4	Analog Inputs. These pins are single-ended analog inputs.
60	AI GND	V6GND	V5GND	V4GND	Analog Input Ground Pins. All analog input AGND pins should connect to the AGND plane of a system.
61	AI/GND	V7	V6	AGND	Analog Input Pins. For the AD7606-4, this is an AGND pin.
62	AI GND/ GND	V7GND	V6GND	AGND	Analog Input Ground Pins. For the AD7606-4, this is an AGND pin.
63	AI/GND	V8	AGND	AGND	Analog Input Pin. For the AD7606-4 and AD7606-6, this is an AGND pin.
64	AI GND/ GND	V8GND	AGND	AGND	Analog Input Ground Pin. For the AD7606-4 and AD7606-6, this is an AGND pin.

¹ P is power supply, DI is digital input, DO is digital output, REF is reference input/output, AI is analog input, GND is ground.

TYPICAL PERFORMANCE CHARACTERISTICS

Temperature range is from -40°C to $+85^{\circ}\text{C}$. The AD7606 is functional up to 105°C with throughput rates $< 160\text{ kSPS}$. Specifications are guaranteed for the operating temperature range of -40°C to $+85^{\circ}\text{C}$ only.

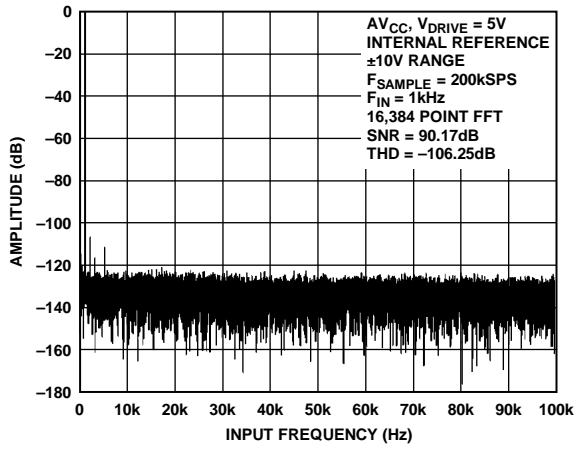

Figure 11. AD7606 FFT, $\pm 10\text{ V}$ Range

08479-011

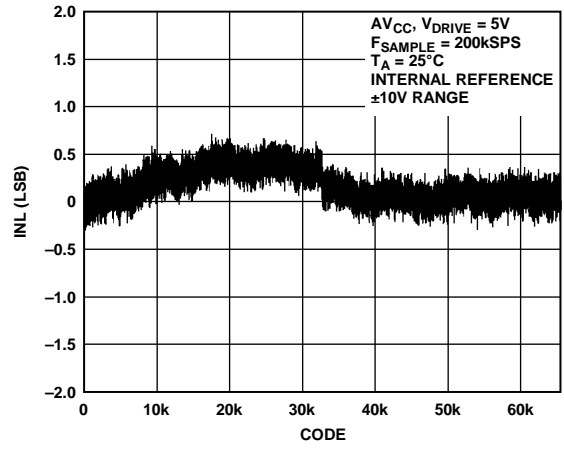

Figure 14. AD7606 Typical INL, $\pm 10\text{ V}$ Range

08479-013

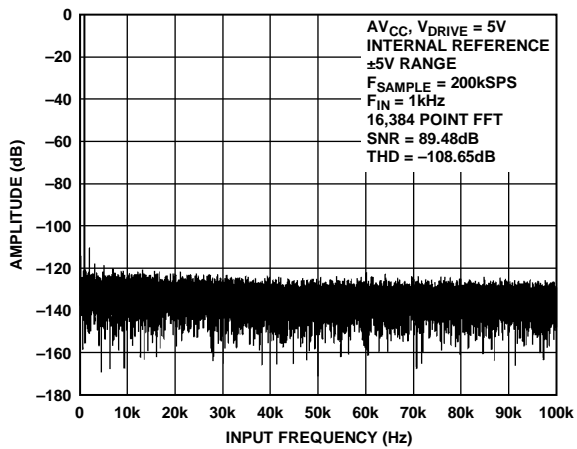

Figure 12. AD7606 FFT Plot, $\pm 5\text{ V}$ Range

08479-012

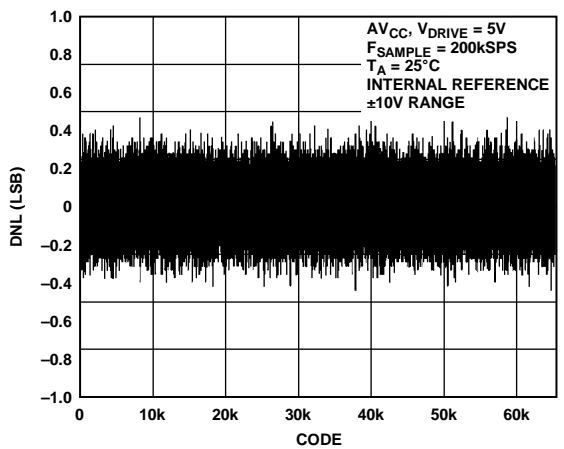

Figure 15. AD7606 Typical DNL, $\pm 10\text{ V}$ Range

08479-014

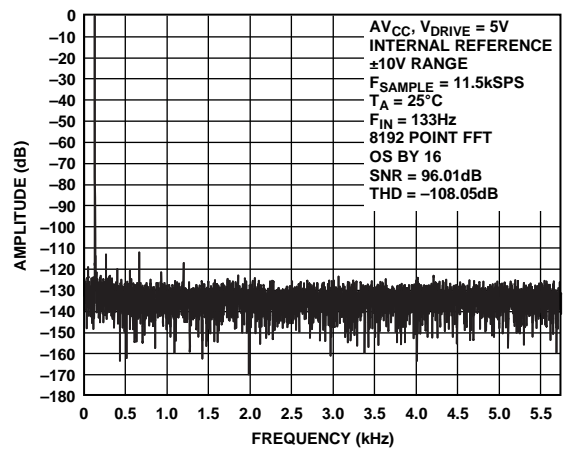

Figure 13. FFT Plot Oversampling By 16, $\pm 10\text{ V}$ Range

08479-031

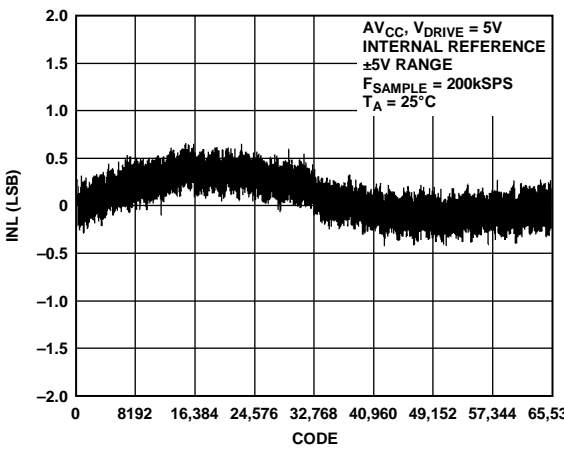

Figure 16. AD7606 Typical INL, $\pm 5\text{ V}$ Range

08479-015

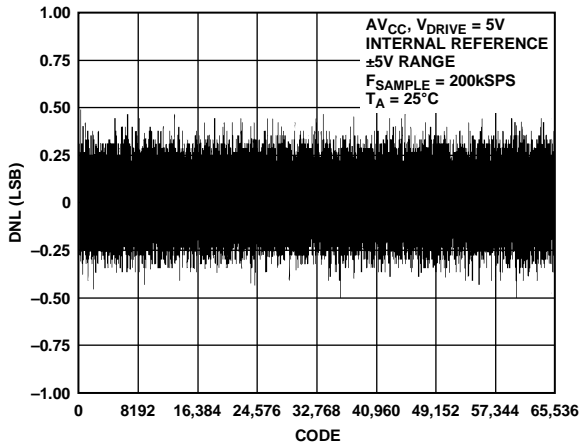

Figure 17. AD7606 Typical DNL, ±5V Range

08479-016

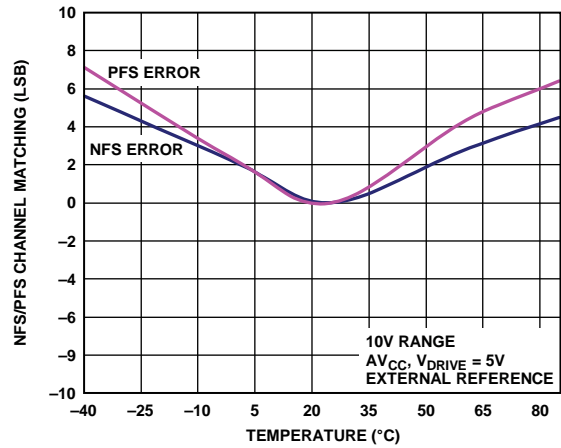

Figure 20. NFS and PFS Error Matching

08479-018

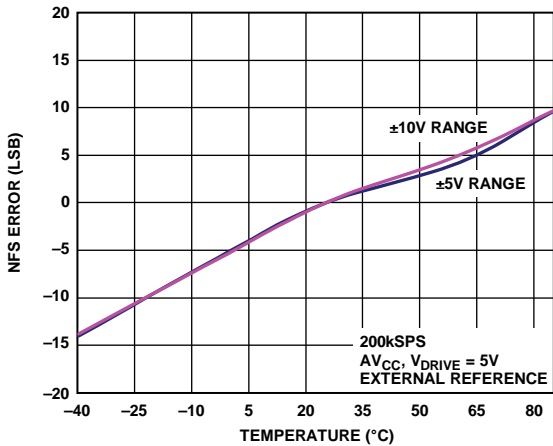

Figure 18. NFS Error vs. Temperature

08479-017

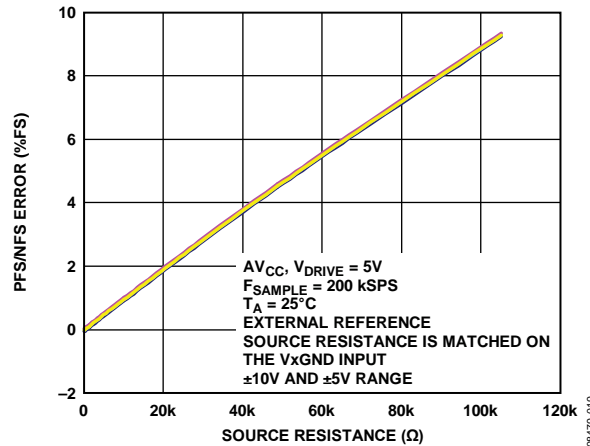

Figure 21. PFS and NFS Error vs. Source Resistance

08479-019

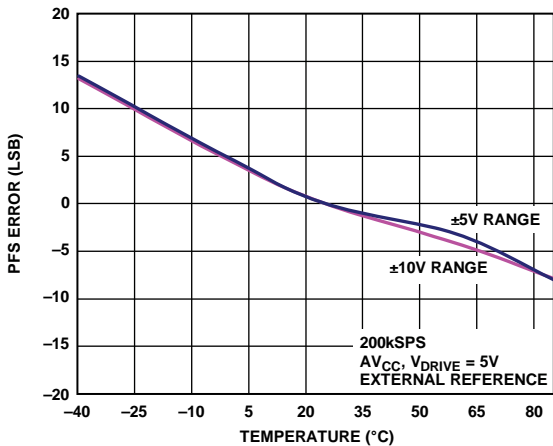

Figure 19. PFS Error vs. Temperature

08479-118

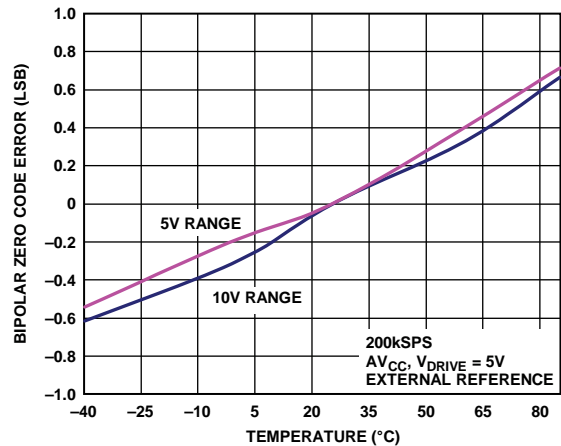

Figure 22. Bipolar Zero Code Error vs. Temperature

08479-023

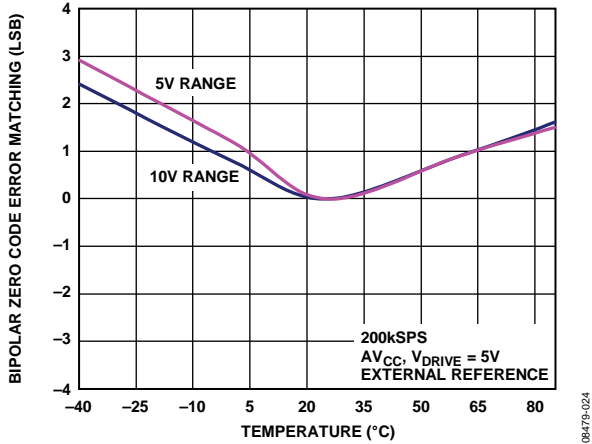

Figure 23. Bipolar Zero Code Error Matching Between Channels

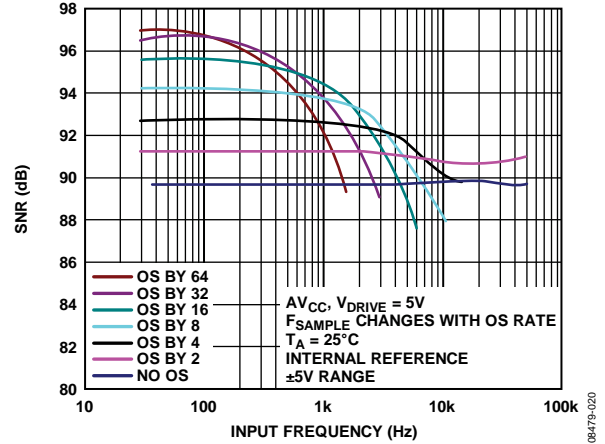

Figure 26. SNR vs. Input Frequency for Different Oversampling Rates, $\pm 5V$ Range

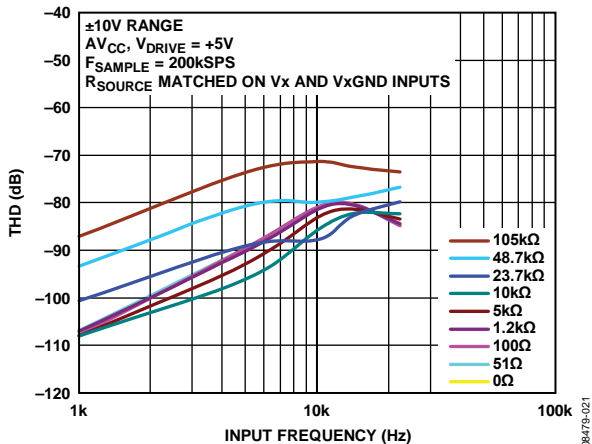

Figure 24. THD vs. Input Frequency for Various Source Impedances, $\pm 10V$ Range

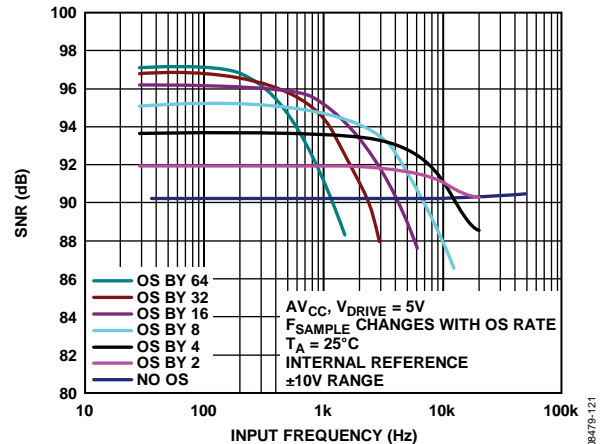

Figure 27. SNR vs. Input Frequency for Different Oversampling Rates, $\pm 10V$ Range

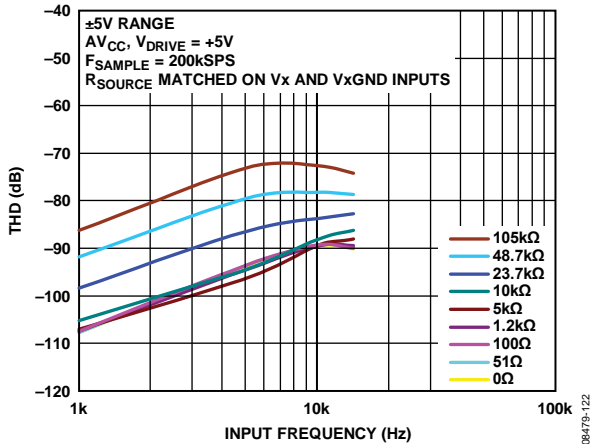

Figure 25. THD vs. Input Frequency for Various Source Impedances, $\pm 5V$ Range

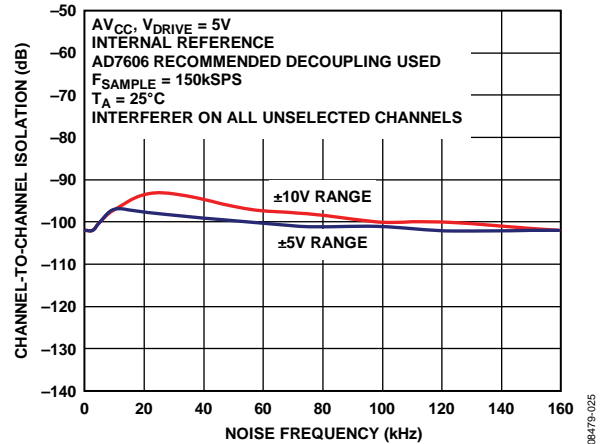

Figure 28. Channel-to-Channel Isolation

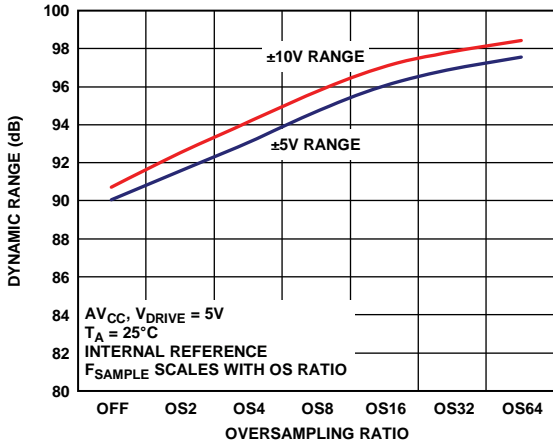

Figure 29. Dynamic Range vs. Oversampling Rate

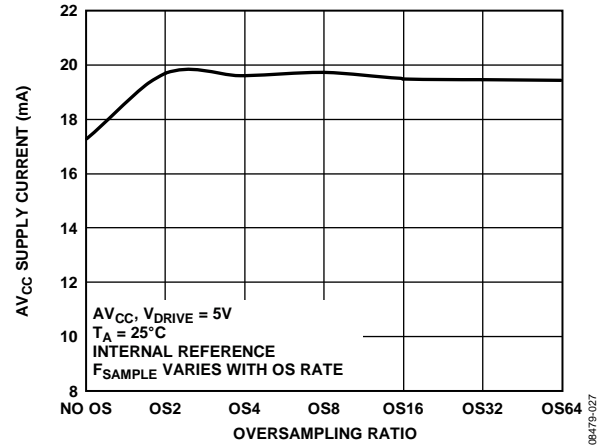

Figure 32. Supply Current vs. Oversampling Rate

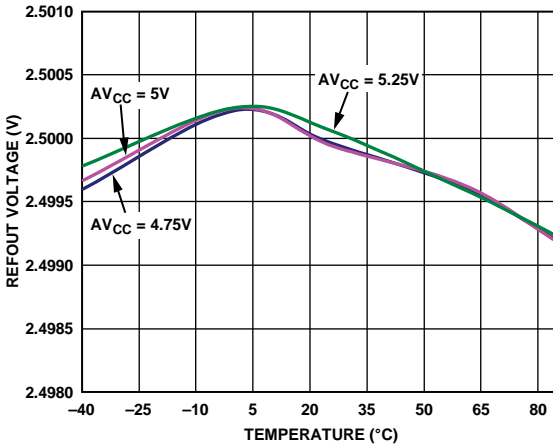

Figure 30. Reference Output Voltage vs. Temperature for Different Supply Voltages

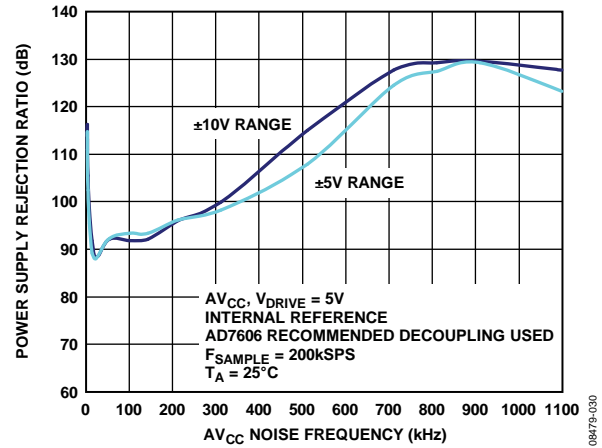

Figure 33. PSRR

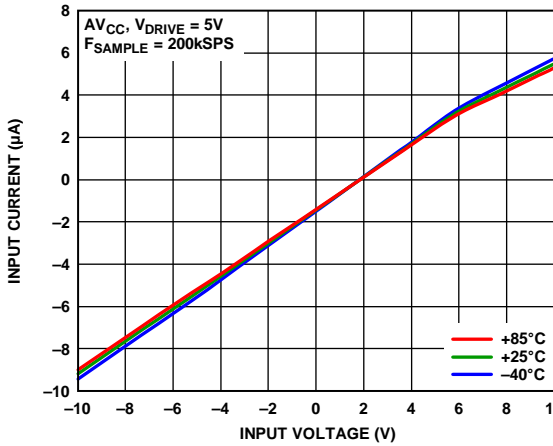

Figure 31. Analog Input Current vs. Temperature for Various Supply Voltages

TERMINOLOGY

Integral Nonlinearity

The maximum deviation from a straight line passing through the endpoints of the ADC transfer function. The endpoints of the transfer function are zero scale, at ½ LSB below the first code transition; and full scale, at ½ LSB above the last code transition.

Differential Nonlinearity

The difference between the measured and the ideal 1 LSB change between any two adjacent codes in the ADC.

Bipolar Zero Code Error

The deviation of the midscale transition (all 1s to all 0s) from the ideal, which is 0 V – ½ LSB.

Bipolar Zero Code Error Match

The absolute difference in bipolar zero code error between any two input channels.

Positive Full-Scale Error

The deviation of the actual last code transition from the ideal last code transition (10 V – ½ LSB (9.99954) and 5 V – ½ LSB (4.99977)) after bipolar zero code error is adjusted out. The positive full-scale error includes the contribution from the internal reference buffer.

Positive Full-Scale Error Match

The absolute difference in positive full-scale error between any two input channels.

Negative Full-Scale Error

The deviation of the first code transition from the ideal first code transition (–10 V + ½ LSB (–9.99984) and –5 V + ½ LSB (–4.99992)) after the bipolar zero code error is adjusted out. The negative full-scale error includes the contribution from the internal reference buffer.

Negative Full-Scale Error Match

The absolute difference in negative full-scale error between any two input channels.

Total Unadjusted Error (TUE)

TUE is a comprehensive specification that includes the gain linearity and offset errors.

Signal-to-(Noise + Distortion) Ratio

The measured ratio of signal-to-(noise + distortion) at the output of the ADC. The signal is the rms amplitude of the fundamental. Noise is the sum of all nonfundamental signals up to half the sampling frequency ($f_s/2$, excluding dc).

The ratio depends on the number of quantization levels in the digitization process: the more levels, the smaller the quantization noise.

The theoretical signal-to-(noise + distortion) ratio for an ideal N-bit converter with a sine wave input is given by

$$\text{Signal-to-(Noise + Distortion)} = (6.02 N + 1.76) \text{ dB}$$

Thus, for a 16-bit converter, the signal-to-(noise + distortion) is 98 dB.

Total Harmonic Distortion (THD)

The ratio of the rms sum of the harmonics to the fundamental. For the AD7606/AD7606-6/AD7606-4, it is defined as

$$\text{THD (dB)} = 20 \log \frac{\sqrt{V_2^2 + V_3^2 + V_4^2 + V_5^2 + V_6^2 + V_7^2 + V_8^2 + V_9^2}}{V_1}$$

where:

V_1 is the rms amplitude of the fundamental.

V_2 to V_9 are the rms amplitudes of the second through ninth harmonics.

Peak Harmonic or Spurious Noise

The ratio of the rms value of the next largest component in the ADC output spectrum (up to $f_s/2$, excluding dc) to the rms value of the fundamental. Normally, the value of this specification is determined by the largest harmonic in the spectrum, but for ADCs where the harmonics are buried in the noise floor, it is determined by a noise peak.

Intermodulation Distortion

With inputs consisting of sine waves at two frequencies, f_a and f_b , any active device with nonlinearities creates distortion products at sum and difference frequencies of $m f_a \pm n f_b$, where $m, n = 0, 1, 2, 3$. Intermodulation distortion terms are those for which neither m nor n is equal to 0. For example, the second-order terms include $(f_a + f_b)$ and $(f_a - f_b)$, and the third-order terms include $(2f_a + f_b)$, $(2f_a - f_b)$, $(f_a + 2f_b)$, and $(f_a - 2f_b)$.

The calculation of the intermodulation distortion is per the THD specification, where it is the ratio of the rms sum of the individual distortion products to the rms amplitude of the sum of the fundamentals expressed in decibels (dB).

Power Supply Rejection Ratio (PSRR)

Variations in power supply affect the full-scale transition but not the converter's linearity. PSR is the maximum change in full-scale transition point due to a change in power supply voltage from the nominal value. The PSR ratio (PSRR) is defined as the ratio of the power in the ADC output at full-scale frequency, f , to the power of a 100 mV p-p sine wave applied to the ADC's V_{DD} and V_{SS} supplies of Frequency f_s .

$$\text{PSRR (dB)} = 10 \log (P_f/P_{f_s})$$

where:

P_f is equal to the power at Frequency f in the ADC output.

P_{f_s} is equal to the power at Frequency f_s coupled onto the AV_{CC} supply.

Channel-to-Channel Isolation

Channel-to-channel isolation is a measure of the level of crosstalk between all input channels. It is measured by applying a full-scale sine wave signal, up to 160 kHz, to all unselected input channels and then determining the degree to which the signal attenuates in the selected channel with a 1 kHz sine wave signal applied (see Figure 28).

THEORY OF OPERATION

CONVERTER DETAILS

The AD7606/AD7606-6/AD7606-4 are data acquisition systems that employ a high speed, low power, charge redistribution, successive approximation analog-to-digital converter (ADC) and allow the simultaneous sampling of eight/six/four analog input channels. The analog inputs on the AD7606/AD7606-6/AD7606-4 can accept true bipolar input signals. The RANGE pin is used to select either ± 10 V or ± 5 V as the input range. The AD7606/AD7606-6/AD7606-4 operate from a single 5 V supply.

The AD7606/AD7606-6/AD7606-4 contain input clamp protection, input signal scaling amplifiers, a second-order anti-aliasing filter, track-and-hold amplifiers, an on-chip reference, reference buffers, a high speed ADC, a digital filter, and high speed parallel and serial interfaces. Sampling on the AD7606/AD7606-6/AD7606-4 is controlled using the CONVST signals.

ANALOG INPUT

Analog Input Ranges

The AD7606/AD7606-6/AD7606-4 can handle true bipolar, single-ended input voltages. The logic level on the RANGE pin determines the analog input range of all analog input channels. If this pin is tied to a logic high, the analog input range is ± 10 V for all channels. If this pin is tied to a logic low, the analog input range is ± 5 V for all channels. A logic change on this pin has an immediate effect on the analog input range; however, there is typically a settling time of approximately 80 μ s, in addition to the normal acquisition time requirement. The recommended practice is to hardwire the RANGE pin according to the desired input range for the system signals.

During normal operation, the applied analog input voltage should remain within the analog input range selected via the RANGE pin. A RESET pulse must be applied after power up to ensure the analog input channels are configured for the range selected.

When in a power-down mode, it is recommended to tie the analog inputs to GND. Per the Analog Input Clamp Protection section, the overvoltage clamp protection is recommended for use in transient overvoltage conditions and should not remain active for extended periods. Stressing the analog inputs outside of the conditions mentioned here may degrade the bipolar zero code error and THD performance of the AD7606/AD7606-6/AD7606-4.

Analog Input Impedance

The analog input impedance of the AD7606/AD7606-6/AD7606-4 is 1 M Ω . This is a fixed input impedance that does not vary with the AD7606 sampling frequency. This high analog input impedance eliminates the need for a driver amplifier in front of the AD7606/AD7606-6/AD7606-4, allowing for direct connection to the source or sensor. With the need for a driver amplifier eliminated, bipolar supplies (which are often a source of noise in a system) can be removed from the signal chain.

Analog Input Clamp Protection

Figure 34 shows the analog input structure of the AD7606/AD7606-6/AD7606-4. Each analog input of the AD7606/AD7606-6/AD7606-4 contains clamp protection circuitry. Despite single 5 V supply operation, this analog input clamp protection allows for an input over voltage of up to ± 16.5 V.

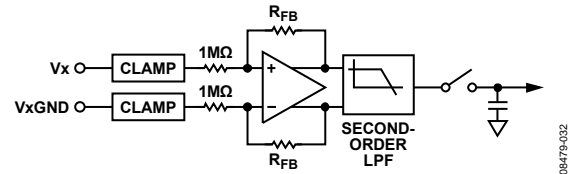

Figure 34. Analog Input Circuitry

Figure 35 shows the voltage vs. current characteristic of the clamp circuit. For input voltages of up to ± 16.5 V, no current flows in the clamp circuit. For input voltages that are above ± 16.5 V, the AD7606/AD7606-6/AD7606-4 clamp circuitry turns on.

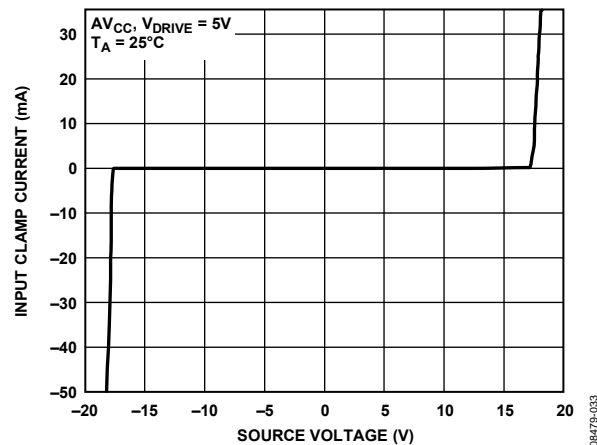

Figure 35. Input Protection Clamp Profile

A series resistor should be placed on the analog input channels to limit the current to ± 10 mA for input voltages above ± 16.5 V. In an application where there is a series resistance on an analog input channel, V_x , a corresponding resistance is required on the analog input GND channel, V_{xGND} (see Figure 36). If there is no corresponding resistor on the V_{xGND} channel, an offset error occurs on that channel. It is recommended that the input overvoltage clamp protection circuitry be used to protect the AD7606/AD7606-6/AD7606-4 against transient overvoltage events. It is not recommended to leave the AD7606/AD7606-6/AD7606-4 in a condition where the clamp protection circuitry is active in normal or power-down conditions for extended periods because this may degrade the bipolar zero code error performance of the AD7606/AD7606-6/AD7606-4.

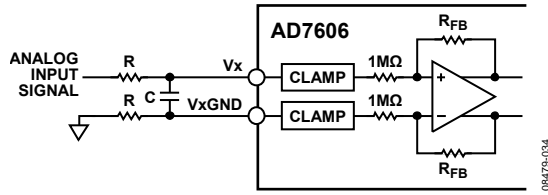

Figure 36. Input Resistance Matching on the Analog Input of the AD7606/AD7606-6/AD7606-4

Analog Input Antialiasing Filter

An analog antialiasing filter (a second-order Butterworth) is also provided on the AD7606/AD7606-6/AD7606-4. Figure 37 and Figure 38 show the frequency and phase response, respectively, of the analog antialiasing filter. In the ± 5 V range, the -3 dB frequency is typically 15 kHz. In the ± 10 V range, the -3 dB frequency is typically 23 kHz.

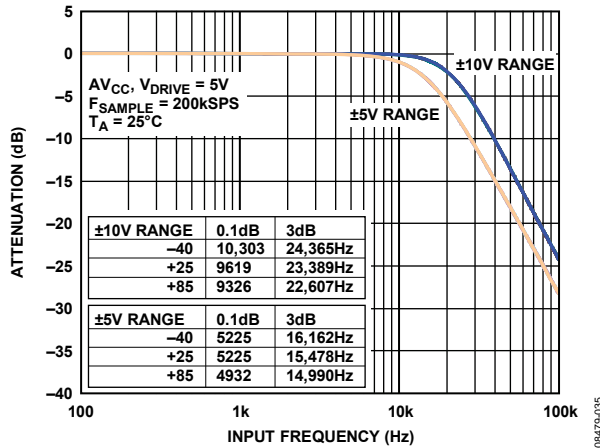

Figure 37. Analog Antialiasing Filter Frequency Response

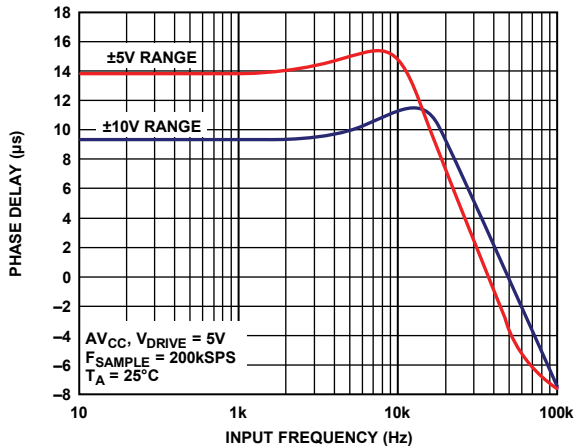

Figure 38. Analog Antialias Filter Phase Response

Track-and-Hold Amplifiers

The track-and-hold amplifiers on the AD7606/AD7606-6/AD7606-4 allow the ADC to accurately acquire an input sine wave of full-scale amplitude to 16-bit resolution. The track-and-hold amplifiers sample their respective inputs simultaneously on the rising edge of CONVST x. The aperture time for the track-and-

hold (that is, the delay time between the external CONVST x signal and the track-and-hold actually going into hold) is well matched, by design, across all eight track-and-holds on one device and from device to device. This matching allows more than one AD7606/AD7606-6/AD7606-4 device to be sampled simultaneously in a system.

The end of the conversion process across all eight channels is indicated by the falling edge of BUSY; and it is at this point that the track-and-holds return to track mode, and the acquisition time for the next set of conversions begins.

The conversion clock for the part is internally generated, and the conversion time for all channels is 4 μ s on the AD7606, 3 μ s on the AD7606-6, and 2 μ s on the AD7606-4. On the AD7606, the BUSY signal returns low after all eight conversions to indicate the end of the conversion process. On the falling edge of BUSY, the track-and-hold amplifiers return to track mode. New data can be read from the output register via the parallel, parallel byte, or serial interface after BUSY goes low; or, alternatively, data from the previous conversion can be read while BUSY is high. Reading data from the AD7606/AD7606-6/AD7606-4 while a conversion is in progress has little effect on performance and allows a faster throughput to be achieved. In parallel mode at $V_{DRIVE} > 3.3$ V, the SNR is reduced by ~ 1.5 dB when reading during a conversion.

ADC TRANSFER FUNCTION

The output coding of the AD7606/AD7606-6/AD7606-4 is two's complement. The designed code transitions occur midway between successive integer LSB values, that is, $1/2$ LSB and $3/2$ LSB. The LSB size is FSR/ $65,536$ for the AD7606. The ideal transfer characteristic for the AD7606/AD7606-6/AD7606-4 is shown in Figure 39.

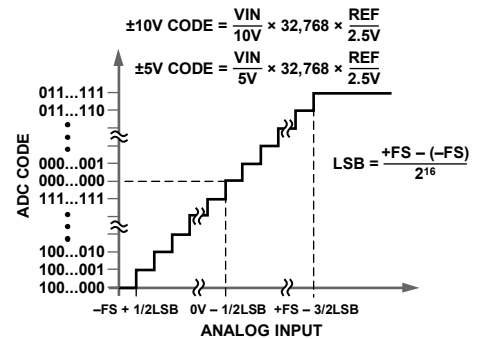

	+FS	MIDSCALE	-FS	LSB
±10V RANGE	+10V	0V	-10V	305 μ V
±5V RANGE	+5V	0V	-5V	152 μ V

Figure 39. AD7606/AD7606-6/AD7606-4 Transfer Characteristics

The LSB size is dependent on the analog input range selected.

INTERNAL/EXTERNAL REFERENCE

The AD7606/AD7606-6/AD7606-4 contain an on-chip 2.5 V band gap reference. The REFIN/REFOUT pin allows access to the 2.5 V reference that generates the on-chip 4.5 V reference internally, or it allows an external reference of 2.5 V to be applied to the AD7606/AD7606-6/AD7606-4. An externally applied reference of 2.5 V is also gained up to 4.5 V, using the internal buffer. This 4.5 V buffered reference is the reference used by the SAR ADC.

The REF SELECT pin is a logic input pin that allows the user to select between the internal reference and an external reference. If this pin is set to logic high, the internal reference is selected and enabled. If this pin is set to logic low, the internal reference is disabled and an external reference voltage must be applied to the REFIN/REFOUT pin. The internal reference buffer is always enabled. After a reset, the AD7606/AD7606-6/AD7606-4 operate in the reference mode selected by the REF SELECT pin. Decoupling is required on the REFIN/REFOUT pin for both the internal and external reference options. A 10 μF ceramic capacitor is required on the REFIN/REFOUT pin.

The AD7606/AD7606-6/AD7606-4 contain a reference buffer configured to gain the REF voltage up to ~ 4.5 V, as shown in Figure 40. The REFCAPA and REFCAPB pins must be shorted together externally, and a ceramic capacitor of 10 μF applied to REFGND, to ensure that the reference buffer is in closed-loop operation. The reference voltage available at the REFIN/REFOUT pin is 2.5 V.

When the AD7606/AD7606-6/AD7606-4 are configured in external reference mode, the REFIN/REFOUT pin is a high input impedance pin. For applications using multiple AD7606 devices, the following configurations are recommended, depending on the application requirements.

External Reference Mode

One ADR421 external reference can be used to drive the REFIN/REFOUT pins of all AD7606 devices (see Figure 41). In this configuration, each REFIN/REFOUT pin of the AD7606/AD7606-6/AD7606-4 should be decoupled with at least a 100 nF decoupling capacitor.

Internal Reference Mode

One AD7606/AD7606-6/AD7606-4 device, configured to operate in the internal reference mode, can be used to drive the remaining AD7606/AD7606-6/AD7606-4 devices, which are configured to operate in external reference mode (see Figure 42). The REFIN/REFOUT pin of the AD7606/AD7606-6/AD7606-4, configured in internal reference mode, should be decoupled using a 10 μF ceramic decoupling capacitor. The other AD7606/AD7606-6/AD7606-4 devices, configured in external reference mode, should use at least a 100 nF decoupling capacitor on their REFIN/REFOUT pins.

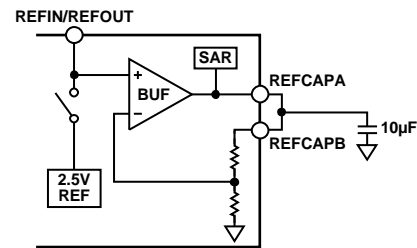

Figure 40. Reference Circuitry

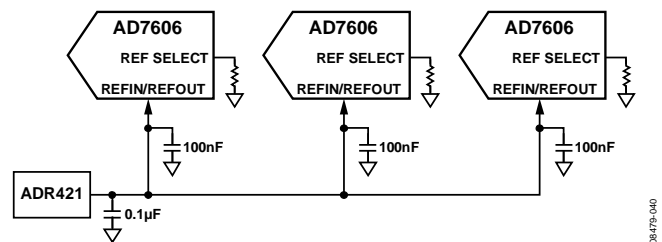

Figure 41. Single External Reference Driving Multiple AD7606/AD7606-6/AD7606-4 REFIN Pins

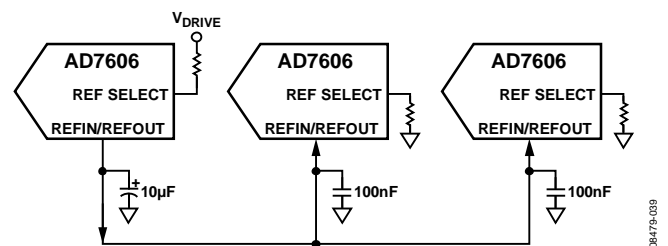

Figure 42. Internal Reference Driving Multiple AD7606/AD7606-6/AD7606-4 REFIN Pins

TYPICAL CONNECTION DIAGRAM

Figure 43 shows the typical connection diagram for the AD7606/AD7606-6/AD7606-4. There are four AV_{CC} supply pins on the part, and each of the four pins should be decoupled using a 100 nF capacitor at each supply pin and a 10 μF capacitor at the supply source. The AD7606/AD7606-6/AD7606-4 can operate with the internal reference or an externally applied reference. In this configuration, the AD7606 is configured to operate with the internal reference. When using a single AD7606/AD7606-6/AD7606-4 device on the board, the REFIN/REFOUT pin should be decoupled with a 10 μF capacitor. Refer to the Internal/External Reference section when using an application with multiple AD7606/AD7606-6/AD7606-4 devices. The REFCAPA and REFCAPB pins are shorted together and decoupled with a 10 μF ceramic capacitor.

The V_{DRIVE} supply is connected to the same supply as the processor. The V_{DRIVE} voltage controls the voltage value of the output logic signals. For layout, decoupling, and grounding hints, see the Layout Guidelines section.

After supplies are applied to the AD7606/AD7606-6/AD7606-4, a reset should be applied to the AD7606/AD7606-6/AD7606-4 to ensure that it is configured for the correct mode of operation.

POWER-DOWN MODES

Two power-down modes are available on the AD7606/AD7606-6/AD7606-4: standby mode and shutdown mode. The STBY pin controls whether the AD7606/AD7606-6/AD7606-4 are in normal mode or in one of the two power-down modes.

The power-down mode is selected through the state of the RANGE pin when the STBY pin is low. Table 7 shows the configurations required to choose the desired power-down mode. When the AD7606/AD7606-6/AD7606-4 are placed in standby mode, the current consumption is 8 mA maximum and power-up time is approximately 100 μs because the capacitor on the REFCAPA and REFCAPB pins must charge up. In standby mode, the on-chip reference and regulators remain powered up, and the amplifiers and ADC core are powered down.

When the AD7606/AD7606-6/AD7606-4 are placed in shutdown mode, the current consumption is 6 μA maximum and power-up time is approximately 13 ms (external reference mode). In shutdown mode, all circuitry is powered down. When the AD7606/AD7606-6/AD7606-4 are powered up from shutdown mode, a RESET signal must be applied to the AD7606/AD7606-6/AD7606-4 after the required power-up time has elapsed.

Table 7. Power-Down Mode Selection

Power-Down Mode	STBY	RANGE
Standby	0	1
Shutdown	0	0

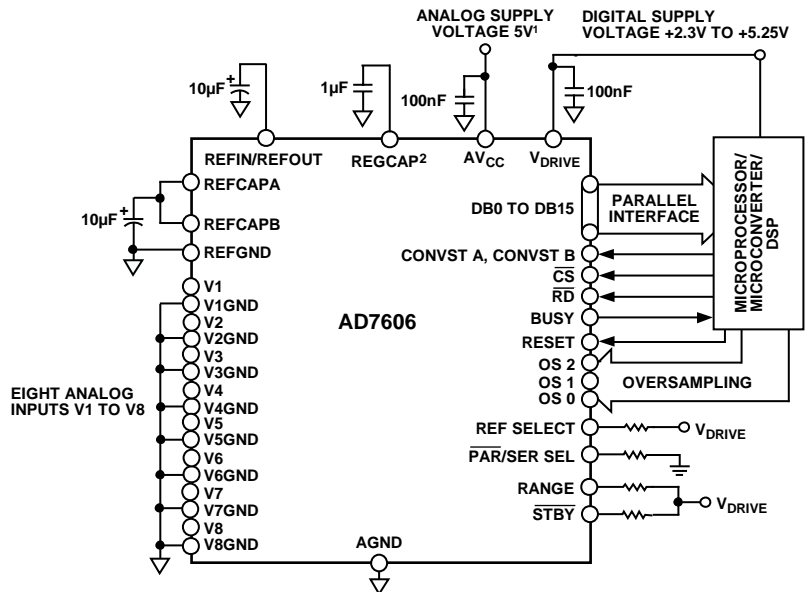

¹DECOUPLING SHOWN ON THE AV_{CC} PIN APPLIES TO EACH AV_{CC} PIN (PIN 1, PIN 37, PIN 38, PIN 48). DECOUPLING CAPACITOR CAN BE SHARED BETWEEN AV_{CC} PIN 37 AND PIN 38.
²DECOUPLING SHOWN ON THE REGCAP PIN APPLIES TO EACH REGCAP PIN (PIN 36, PIN 39).

Figure 43. AD7606 Typical Connection Diagram

CONVERSION CONTROL

Simultaneous Sampling on All Analog Input Channels

The AD7606/AD7606-6/AD7606-4 allow simultaneous sampling of all analog input channels. All channels are sampled simultaneously when both CONVST pins (CONVST A, CONVST B) are tied together. A single CONVST signal is used to control both CONVST x inputs. The rising edge of this common CONVST signal initiates simultaneous sampling on all analog input channels (V1 to V8 for the AD7606, V1 to V6 for the AD7606-6, and V1 to V4 for the AD7606-4).

The AD7606 contains an on-chip oscillator that is used to perform the conversions. The conversion time for all ADC channels is t_{CONV} . The BUSY signal indicates to the user when conversions are in progress, so when the rising edge of CONVST is applied, BUSY goes logic high and transitions low at the end of the entire conversion process. The falling edge of the BUSY signal is used to place all eight track-and-hold amplifiers back into track mode. The falling edge of BUSY also indicates that the new data can now be read from the parallel bus (DB[15:0]), the D_{OUTA} and D_{OUTB} serial data lines, or the parallel byte bus, DB[7:0].

Simultaneously Sampling Two Sets of Channels

The AD7606/AD7606-6/AD7606-4 also allow the analog input channels to be sampled simultaneously in two sets. This can be used in power-line protection and measurement systems to compensate for phase differences introduced by PT and CT

transformers. In a 50 Hz system, this allows for up to 9° of phase compensation; and in a 60 Hz system, it allows for up to 10° of phase compensation.

This is accomplished by pulsing the two CONVST pins independently and is possible only if oversampling is not in use. CONVST A is used to initiate simultaneous sampling of the first set of channels (V1 to V4 for the AD7606, V1 to V3 for the AD7606-6, and V1 and V2 for the AD7606-4); and CONVST B is used to initiate simultaneous sampling on the second set of analog input channels (V5 to V8 for the AD7606, V4 to V6 for the AD7606-6, and V3 and V4 for the AD7606-4), as illustrated in Figure 44. On the rising edge of CONVST A, the track-and-hold amplifiers for the first set of channels are placed into hold mode. On the rising edge of CONVST B, the track-and-hold amplifiers for the second set of channels are placed into hold mode. The conversion process begins once both rising edges of CONVST x have occurred; therefore BUSY goes high on the rising edge of the later CONVST x signal. In Table 3, Time t_5 indicates the maximum allowable time between CONVST x sampling points.

There is no change to the data read process when using two separate CONVST x signals.

Connect all unused analog input channels to AGND. The results for any unused channels are still included in the data read because all channels are always converted.

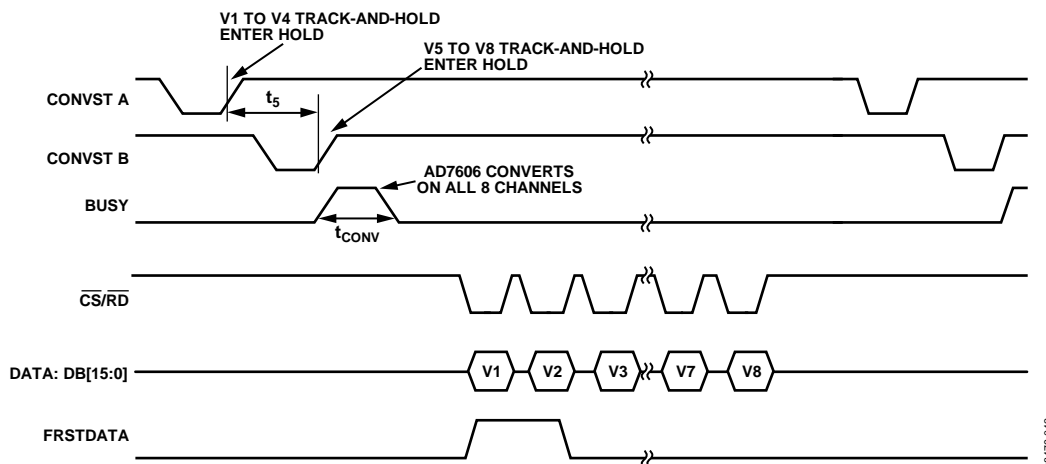

Figure 44. AD7606 Simultaneous Sampling on Channel Sets While Using Independent CONVST A and CONVST B Signals—Parallel Mode

DIGITAL INTERFACE

The AD7606/AD7606-6/AD7606-4 provide three interface options: a parallel interface, a high speed serial interface, and a parallel byte interface. The required interface mode is selected via the $\overline{\text{PAR/SER/BYTE SEL}}$ and DB15/BYTE SEL pins.

Table 8. Interface Mode Selection

$\overline{\text{PAR/SER/BYTE SEL}}$	DB15	Interface Mode
0	0	Parallel interface mode
1	0	Serial interface mode
1	1	Parallel byte interface mode

Operation of the interface modes is discussed in the following sections.

PARALLEL INTERFACE ($\overline{\text{PAR/SER/BYTE SEL}} = 0$)

Data can be read from the AD7606/AD7606-6/AD7606-4 via the parallel data bus with standard $\overline{\text{CS}}$ and $\overline{\text{RD}}$ signals. To read the data over the parallel bus, the $\overline{\text{PAR/SER/BYTE SEL}}$ pin should be tied low. The $\overline{\text{CS}}$ and $\overline{\text{RD}}$ input signals are internally gated to enable the conversion result onto the data bus. The data lines, DB15 to DB0, leave their high impedance state when both $\overline{\text{CS}}$ and $\overline{\text{RD}}$ are logic low.

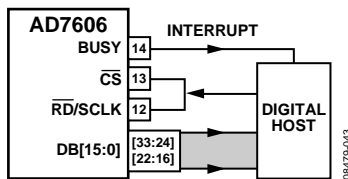

Figure 45. AD7606 Interface Diagram—One AD7606 Using the Parallel Bus, with $\overline{\text{CS}}$ and $\overline{\text{RD}}$ Shorted Together

The rising edge of the $\overline{\text{CS}}$ input signal three-states the bus, and the falling edge of the $\overline{\text{CS}}$ input signal takes the bus out of the high impedance state. $\overline{\text{CS}}$ is the control signal that enables the data lines; it is the function that allows multiple AD7606/AD7606-6/AD7606-4 devices to share the same parallel data bus.

The $\overline{\text{CS}}$ signal can be permanently tied low, and the $\overline{\text{RD}}$ signal can be used to access the conversion results as shown in Figure 4. A read operation of new data can take place after the BUSY signal goes low (see Figure 2); or, alternatively, a read operation of data from the previous conversion process can take place while BUSY is high (see Figure 3).

The $\overline{\text{RD}}$ pin is used to read data from the output conversion results register. Applying a sequence of $\overline{\text{RD}}$ pulses to the $\overline{\text{RD}}$ pin of the AD7606/AD7606-6/AD7606-4 clocks the conversion results out from each channel onto the Parallel Bus DB[15:0] in ascending order. The first $\overline{\text{RD}}$ falling edge after BUSY goes low clocks out the conversion result from Channel V1. The next $\overline{\text{RD}}$ falling edge updates the bus with the V2 conversion result, and so on. On the AD7606, the eighth falling edge of $\overline{\text{RD}}$ clocks out the conversion result for Channel V8.

When the $\overline{\text{RD}}$ signal is logic low, it enables the data conversion result from each channel to be transferred to the digital host (DSP, FPGA).

When there is only one AD7606/AD7606-6/AD7606-4 in a system/board and it does not share the parallel bus, data can be read using just one control signal from the digital host. The $\overline{\text{CS}}$ and $\overline{\text{RD}}$ signals can be tied together, as shown in Figure 5. In this case, the data bus comes out of three-state on the falling edge of $\overline{\text{CS/RD}}$. The combined $\overline{\text{CS}}$ and $\overline{\text{RD}}$ signal allows the data to be clocked out of the AD7606/AD7606-6/AD7606-4 and to be read by the digital host. In this case, $\overline{\text{CS}}$ is used to frame the data transfer of each data channel.

PARALLEL BYTE ($\overline{\text{PAR/SER/BYTE SEL}} = 1$, DB15 = 1)

Parallel byte interface mode operates much like the parallel interface mode, except that each channel conversion result is read out in two 8-bit transfers. Therefore, 16 $\overline{\text{RD}}$ pulses are required to read all eight conversion results from the AD7606. For the AD7606-6, 12 $\overline{\text{RD}}$ pulses are required; and on the AD7606-4, eight $\overline{\text{RD}}$ pulses are required to read all the channel results. To configure the AD7606/AD7606-6/AD7606-4 to operate in parallel byte mode, the $\overline{\text{PAR/SER/BYTE SEL}}$ and BYTE SEL/DB15 pins should be tied to logic high (see Table 8). In parallel byte mode, DB[7:0] are used to transfer the data to the digital host. DB0 is the LSB of the data transfer, and DB7 is the MSB of the data transfer. In parallel byte mode, DB14 acts as an HBEN pin. When DB14/HBEN is tied to logic high, the most significant byte (MSB) of the conversion result is output first, followed by the LSB of the conversion result. When DB14 is tied to logic low, the LSB of the conversion result is output first, followed by the MSB of the conversion result. The FRSTDATA pin remains high until the entire 16 bits of the conversion result from V1 are read from the AD7606/AD7606-6/AD7606-4.

SERIAL INTERFACE ($\overline{\text{PAR/SER/BYTE SEL}} = 1$)

To read data back from the AD7606 over the serial interface, the $\overline{\text{PAR/SER/BYTE SEL}}$ pin must be tied high. The $\overline{\text{CS}}$ and SCLK signals are used to transfer data from the AD7606. The AD7606/AD7606-6/AD7606-4 have two serial data output pins, D_{OUTA} and D_{OUTB}. Data can be read back from the AD7606/AD7606-6/AD7606-4 using one or both of these D_{OUT} lines. For the AD7606, conversion results from Channel V1 to Channel V4 first appear on D_{OUTA}, and conversion results from Channel V5 to Channel V8 first appear on D_{OUTB}. For the AD7606-6, conversion results from Channel V1 to Channel V3 first appear on D_{OUTA}, and conversion results from Channel V4 to Channel V6 first appear on D_{OUTB}. For the AD7606-4, conversion results from Channel V1 and Channel V2 first appear on D_{OUTA}, and conversion results from Channels V3 and Channel V4 first appear on D_{OUTB}.

The $\overline{\text{CS}}$ falling edge takes the data output lines, D_{OUTA} and D_{OUTB} , out of three-state and clocks out the MSB of the conversion result. The rising edge of SCLK clocks all subsequent data bits onto the serial data outputs, D_{OUTA} and D_{OUTB} . The $\overline{\text{CS}}$ input can be held low for the entire serial read operation, or it can be pulsed to frame each channel read of 16 SCLK cycles. Figure 46 shows a read of eight simultaneous conversion results using two D_{OUT} lines on the AD7606. In this case, a 64 SCLK transfer is used to access data from the AD7606, and $\overline{\text{CS}}$ is held low to frame the entire 64 SCLK cycles. Data can also be clocked out using just one D_{OUT} line, in which case it is recommended that D_{OUTA} be used to access all conversion data because the channel data is output in ascending order. For the AD7606 to access all eight conversion results on one D_{OUT} line, a total of 128 SCLK cycles is required. These 128 SCLK cycles can be framed by one $\overline{\text{CS}}$ signal, or each group of 16 SCLK cycles can be individually framed by the $\overline{\text{CS}}$ signal. The disadvantage of using just one D_{OUT} line is that the throughput rate is reduced if reading occurs after conversion. The unused D_{OUT} line should be left unconnected in serial mode. For the AD7606, if D_{OUTB} is to be used as a single D_{OUT} line, the channel results are output in the following order: V5, V6, V7, V8, V1, V2, V3, and V4; however, the FRSTDATA indicator returns low after V5 is read on D_{OUTB} . For the AD7606-6 and the AD7606-4, if D_{OUTB} is to be used as a single D_{OUT} line, the channel results are output in the following order: V4, V5, V6, V1, V2, and V3 for the AD7606-6; and V3, V4, V1, and V2 for the AD7606-4.

Figure 6 shows the timing diagram for reading one channel of data, framed by the $\overline{\text{CS}}$ signal, from the AD7606/AD7606-6/AD7606-4 in serial mode. The SCLK input signal provides the clock source for the serial read operation. The $\overline{\text{CS}}$ goes low to access the data from the AD7606/AD7606-6/AD7606-4.

The falling edge of $\overline{\text{CS}}$ takes the bus out of three-state and clocks out the MSB of the 16-bit conversion result. This MSB is valid on the first falling edge of the SCLK after the $\overline{\text{CS}}$ falling edge. The subsequent 15 data bits are clocked out of the AD7606/AD7606-6/AD7606-4 on the SCLK rising edge. Data is valid on the SCLK falling edge. To access each conversion result, 16 clock cycles must be provided to the AD7606/AD7606-6/AD7606-4.

The FRSTDATA output signal indicates when the first channel, V1, is being read back. When the $\overline{\text{CS}}$ input is high, the FRSTDATA output pin is in three-state. In serial mode, the falling edge of $\overline{\text{CS}}$ takes FRSTDATA out of three-state and sets the FRSTDATA pin high, indicating that the result from V1 is available on the D_{OUTA} output data line. The FRSTDATA output returns to a logic low following the 16th SCLK falling edge. If all channels are read on D_{OUTB} , the FRSTDATA output does not go high when V1 is being output on this serial data output pin. It goes high only when V1 is available on D_{OUTA} (and this is when V5 is available on D_{OUTB} for the AD7606).

READING DURING CONVERSION

Data can be read from the AD7606/AD7606-6/AD7606-4 while BUSY is high and the conversions are in progress. This has little effect on the performance of the converter, and it allows a faster throughput rate to be achieved. A parallel, parallel byte, or serial read can be performed during conversions and when oversampling may or may not be in use. Figure 3 shows the timing diagram for reading while BUSY is high in parallel or serial mode. Reading during conversions allows the full throughput rate to be achieved when using the serial interface with V_{DRIVE} above 4.75 V.

Data can be read from the AD7606 at any time other than on the falling edge of BUSY because this is when the output data registers are updated with the new conversion data. Time t_6 , as outlined in Table 3, should be observed in this condition.

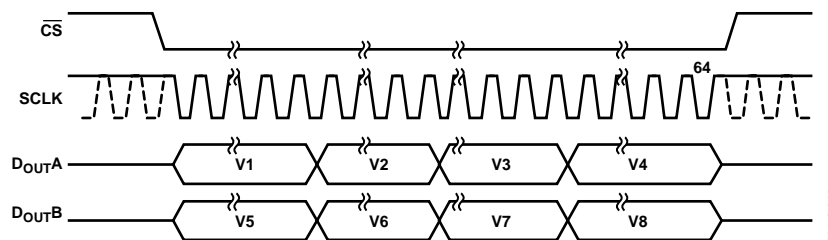

Figure 46. AD7606 Serial Interface with Two D_{OUT} Lines

08479-044

DIGITAL FILTER

The AD7606/AD7606-6/AD7606-4 contain an optional digital first-order sinc filter that should be used in applications where slower throughput rates are used or where higher signal-to-noise ratio or dynamic range is desirable. The oversampling ratio of the digital filter is controlled using the oversampling pins, OS [2:0] (see Table 9). OS 2 is the MSB control bit, and OS 0 is the LSB control bit. Table 9 provides the oversampling bit decoding to select the different oversample rates. The OS pins are latched on the falling edge of BUSY. This sets the oversampling rate for the next conversion (see Figure 48). In addition to the oversampling function, the output result is decimated to 16-bit resolution.

If the OS pins are set to select an OS ratio of eight, the next CONVST x rising edge takes the first sample for each channel, and the remaining seven samples for all channels are taken with an internally generated sampling signal. These samples are then averaged to yield an improvement in SNR performance. Table 9 shows typical SNR performance for both the ±10 V and the ±5 V range. As Table 9 shows, there is an improvement in SNR as the OS ratio increases. As the OS ratio increases, the 3 dB frequency is reduced, and the allowed sampling frequency is also reduced. In an application where the required sampling frequency is 10 kSPS, an OS ratio of up to 16 can be used. In this case, the application sees an improvement in SNR, but the input 3 dB bandwidth is limited to ~6 kHz.

The CONVST A and CONVST B pins must be tied/driven together when oversampling is turned on. When the oversampling function is turned on, the BUSY high time for the conversion process extends. The actual BUSY high time depends on the oversampling rate that is selected: the higher the oversampling rate, the longer the BUSY high, or total conversion time (see Table 3).

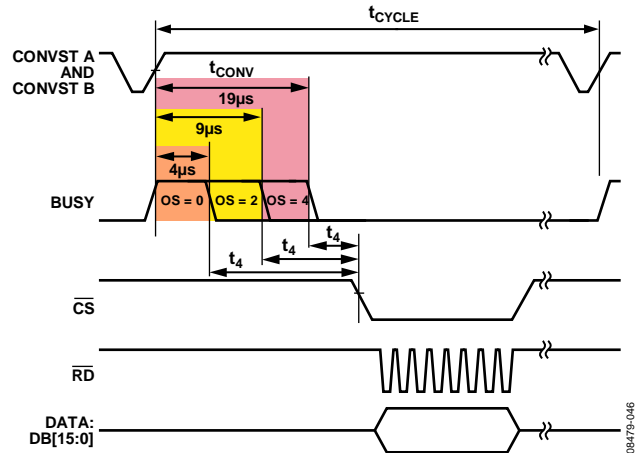

Figure 47. AD7606—No Oversampling, Oversampling × 2, and Oversampling × 4 While Using Read After Conversion

Figure 47 shows that the conversion time extends as the oversampling rate is increased, and the BUSY signal lengthens for the different oversampling rates. For example, a sampling frequency of 10 kSPS yields a cycle time of 100 µs. Figure 47 shows OS × 2 and OS × 4; for a 10 kSPS example, there is adequate cycle time to further increase the oversampling rate and yield greater improvements in SNR performance. In an application where the initial sampling or throughput rate is at 200 kSPS, for example, and oversampling is turned on, the throughput rate must be reduced to accommodate the longer conversion time and to allow for the read. To achieve the fastest throughput rate possible when oversampling is turned on, the read can be performed during the BUSY high time. The falling edge of BUSY is used to update the output data registers with the new conversion data; therefore, the reading of conversion data should not occur on this edge.

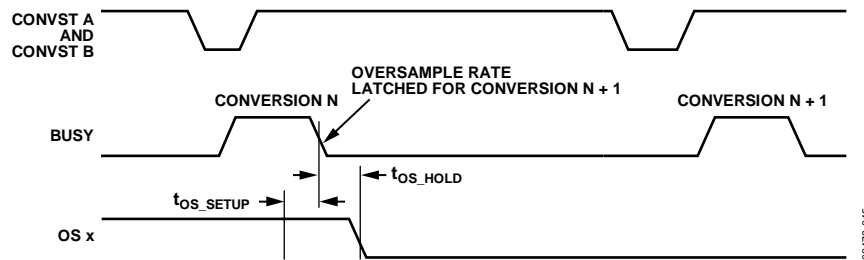

Figure 48. OS x Pin Timing

Table 9. Oversample Bit Decoding

OS[2:0]	OS Ratio	SNR 5 V Range (dB)	SNR 10 V Range (dB)	3 dB BW 5 V Range (kHz)	3 dB BW 10 V Range (kHz)	Maximum Throughput CONVST Frequency (kHz)
000	No OS	89	90	15	22	200
001	2	91.2	92	15	22	100
010	4	92.6	93.6	13.7	18.5	50
011	8	94.2	95	10.3	11.9	25
100	16	95.5	96	6	6	12.5
101	32	96.4	96.7	3	3	6.25
110	64	96.9	97	1.5	1.5	3.125
111	Invalid					

Figure 49 to Figure 55 illustrate the effect of oversampling on the code spread in a dc histogram plot. As the oversample rate is increased, the spread of the codes is reduced.

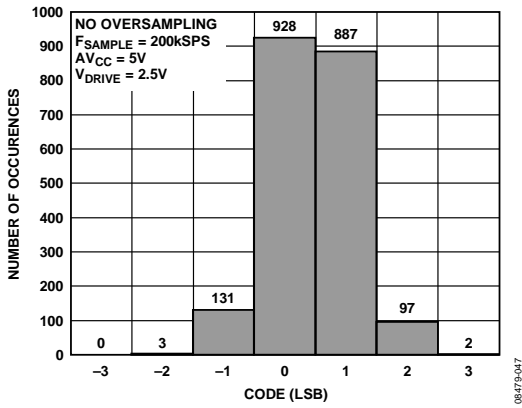

Figure 49. Histogram of Codes—No OS (Six Codes)

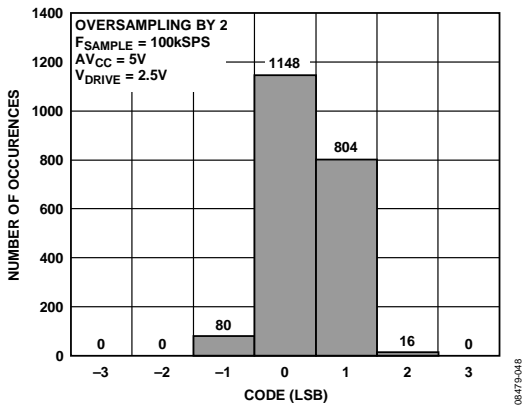

Figure 50. Histogram of Codes—OS x 2 (Four Codes)

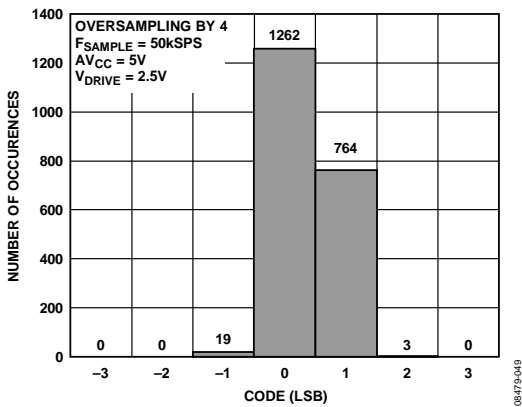

Figure 51. Histogram of Codes—OS x 4 (Four Codes)

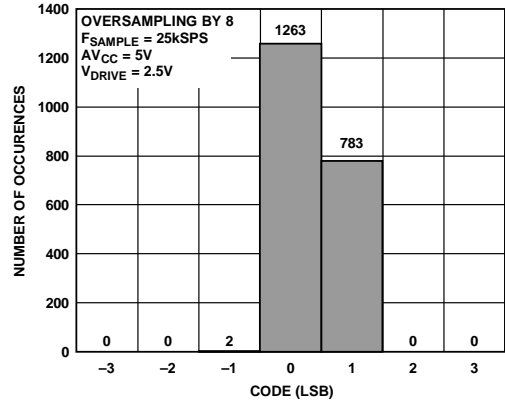

Figure 52. Histogram of Codes—OS x 8 (Three Codes)

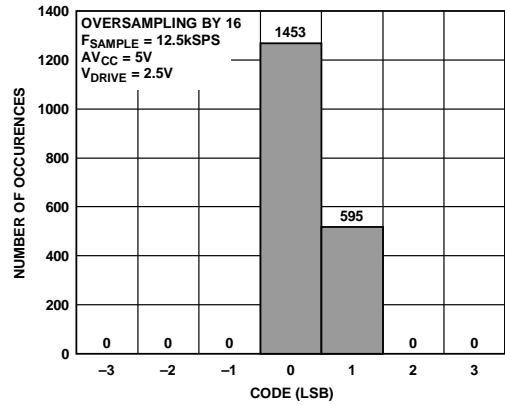

Figure 53. Histogram of Codes—OS x 16 (Two Codes)

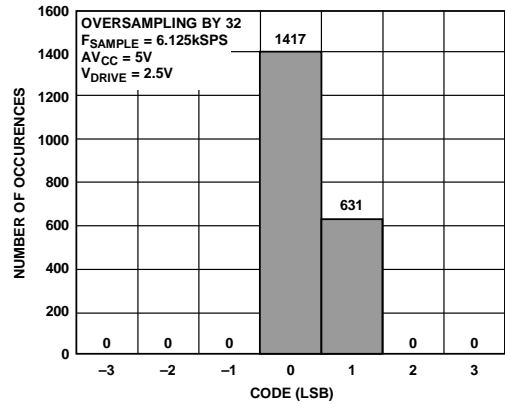

Figure 54. Histogram of Codes—OS x 32 (Two Codes)

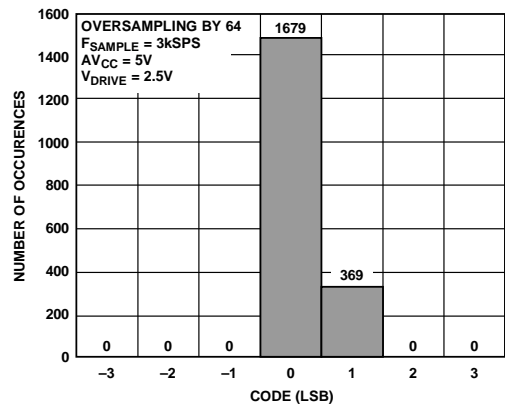

Figure 55. Histogram of Codes—OS x 64 (Two Codes)

When the oversampling mode is selected for the AD7606/AD7606-6/AD7606-4, it has the effect of adding a digital filter function after the ADC. The different oversampling rates and the CONVST sampling frequency produce different digital filter frequency profiles.

Figure 56 to Figure 61 show the digital filter frequency profiles for the different oversampling rates. The combination of the analog antialiasing filter and the oversampling digital filter can be used to eliminate and reduce the complexity of the design of any filter before the AD7606/AD7606-6/AD7606-4. The digital filtering combines steep roll-off and linear phase response.

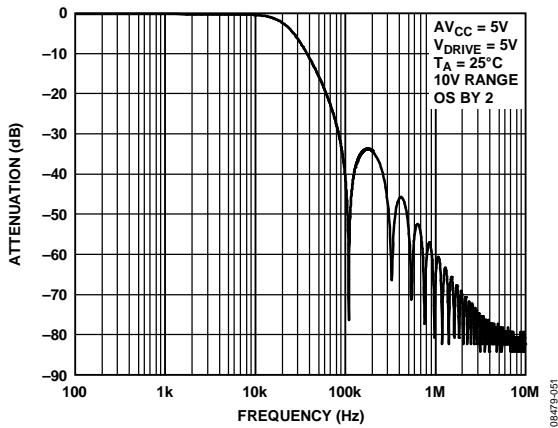

Figure 56. Digital Filter Response for OS 2

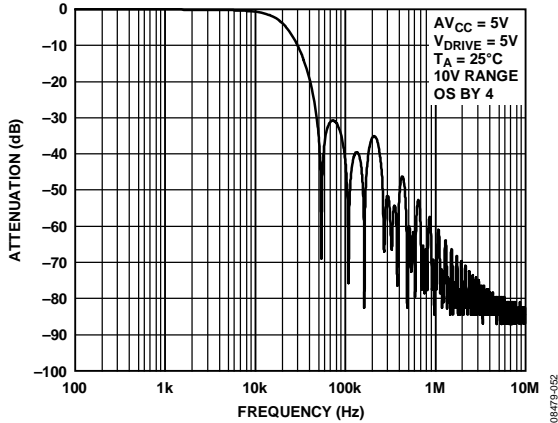

Figure 57. Digital Filter Response for OS 4

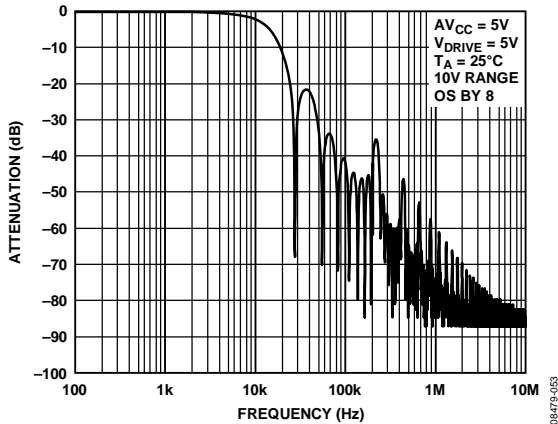

Figure 58. Digital Filter Response for OS 8

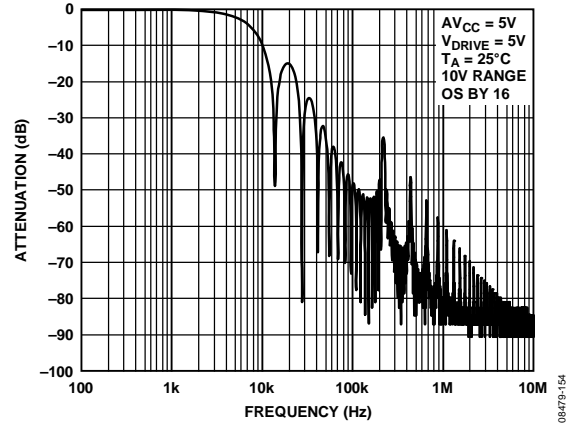

Figure 59. Digital Filter Response for OS 16

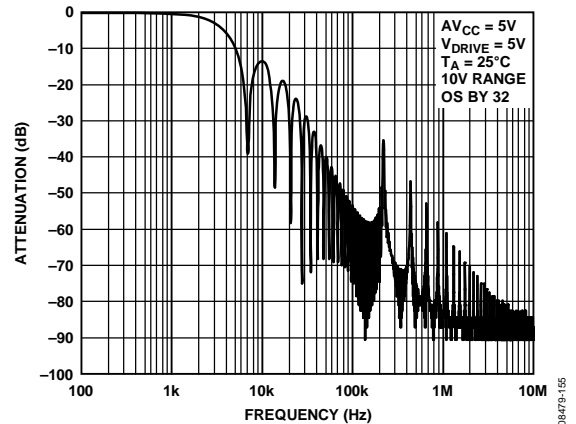

Figure 60. Digital Filter Response for OS 32

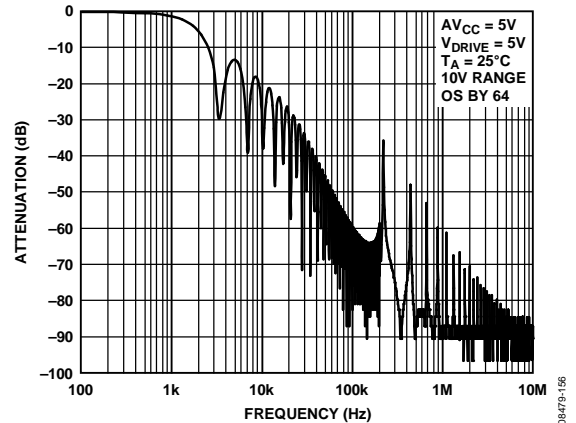

Figure 61. Digital Filter Response for OS 64

LAYOUT GUIDELINES

The printed circuit board that houses the AD7606/AD7606-6/AD7606-4 should be designed so that the analog and digital sections are separated and confined to different areas of the board.

At least one ground plane should be used. It can be common or split between the digital and analog sections. In the case of the split plane, the digital and analog ground planes should be joined in only one place, preferably as close as possible to the AD7606/AD7606-6/AD7606-4.

If the AD7606/AD7606-6/AD7606-4 are in a system where multiple devices require analog-to-digital ground connections, the connection should still be made at only one point: a star ground point that should be established as close as possible to the AD7606/AD7606-6/AD7606-4. Good connections should be made to the ground plane. Avoid sharing one connection for multiple ground pins. Use individual vias or multiple vias to the ground plane for each ground pin.

Avoid running digital lines under the devices because doing so couples noise onto the die. The analog ground plane should be allowed to run under the AD7606/AD7606-6/AD7606-4 to avoid noise coupling. Fast switching signals like CONVST A, CONVST B, or clocks should be shielded with digital ground to avoid radiating noise to other sections of the board, and they should never run near analog signal paths. Avoid crossover of digital and analog signals. Traces on layers in close proximity on the board should run at right angles to each other to reduce the effect of feedthrough through the board.

The power supply lines to the AV_{CC} and V_{DRIVE} pins on the AD7606/AD7606-6/AD7606-4 should use as large a trace as possible to provide low impedance paths and reduce the effect of glitches on the power supply lines. Where possible, use supply planes and make good connections between the AD7606 supply pins and the power tracks on the board. Use a single via or multiple vias for each supply pin.

Good decoupling is also important to lower the supply impedance presented to the AD7606/AD7606-6/AD7606-4 and to reduce the magnitude of the supply spikes. The decoupling capacitors should be placed close to (ideally, right up against) these pins and their corresponding ground pins. Place the decoupling capacitors for the REFIN/REFOUT pin and the REFCAPA and REFCAPB pins as close as possible to their respective AD7606/AD7606-6/AD7606-4 pins; and, where possible, they should be placed on the same side of the board as the AD7606 device.

Figure 62 shows the recommended decoupling on the top layer of the AD7606 board. Figure 63 shows bottom layer decoupling which is used for the four AV_{CC} pins and the V_{DRIVE} pin decoupling. Where the ceramic 100 nF caps for the AV_{CC} pins are placed close to their respective device pins, a single 100 nF capacitor can be shared between Pin 37 and Pin 38.



Figure 62. Top Layer Decoupling REFIN/REFOUT, REFCAPA, REFCAPB, and REGCAP Pins



Figure 63. Bottom Layer Decoupling

To ensure good device-to-device performance matching in a system that contains multiple AD7606/AD7606-6/AD7606-4 devices, a symmetrical layout between the AD7606/AD7606-6/AD7606-4 devices is important.

Figure 64 shows a layout with two AD7606/AD7606-6/AD7606-4 devices. The AV_{CC} supply plane runs to the right of both devices, and the V_{DRIVE} supply track runs to the left of the two devices. The reference chip is positioned between the two devices, and the reference voltage track runs north to Pin 42 of U1 and south to Pin 42 of U2. A solid ground plane is used.

These symmetrical layout principles can also be applied to a system that contains more than two AD7606/AD7606-6/AD7606-4 devices. The AD7606/AD7606-6/AD7606-4 devices can be placed in a north-south direction, with the reference voltage located midway between the devices and the reference track running in the north-south direction, similar to Figure 64.

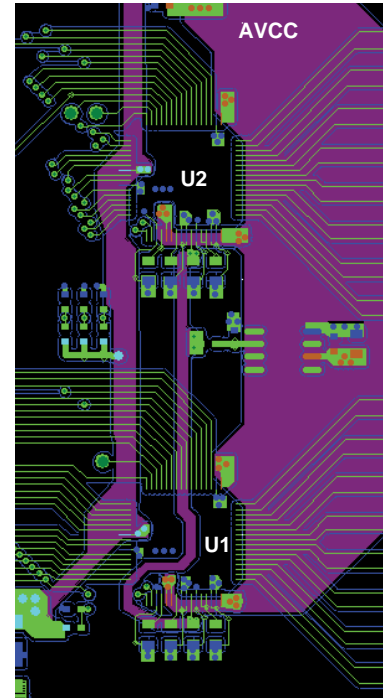
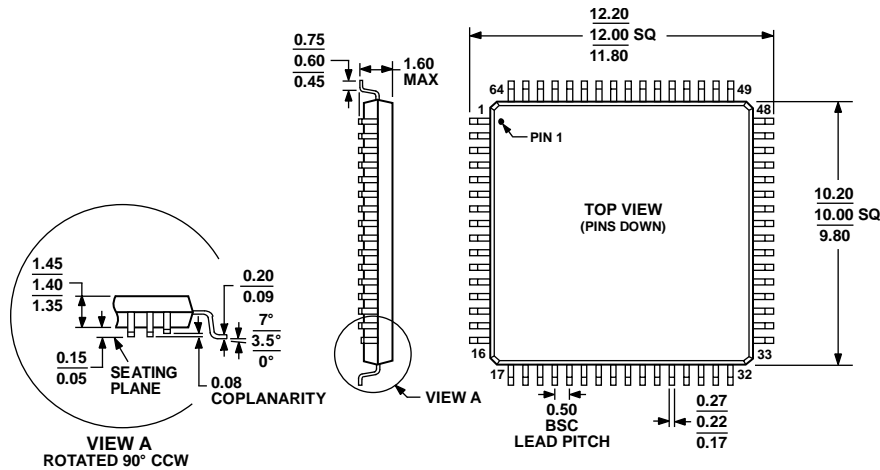

Figure 64. Layout for Multiple AD7606 Devices—Top Layer and Supply Plane Layer

OUTLINE DIMENSIONS



COMPLIANT TO JEDEC STANDARDS MS-026-BCD

Figure 65. 64-Lead Low Profile Quad Flat Package [LQFP] (ST-64-2)

Dimensions shown in millimetres

051706-A

ORDERING GUIDE

Model ^{1, 2, 3}	Temperature Range	Package Description	Package Option
AD7606BSTZ	-40°C to +85°C	64-Lead Low Profile Quad Flat Package [LQFP]	ST-64-2
AD7606BSTZ-RL	-40°C to +85°C	64-Lead Low Profile Quad Flat Package [LQFP]	ST-64-2
AD7606BSTZ-6	-40°C to +85°C	64-Lead Low Profile Quad Flat Package [LQFP]	ST-64-2
AD7606BSTZ-6RL	-40°C to +85°C	64-Lead Low Profile Quad Flat Package [LQFP]	ST-64-2
AD7606BSTZ-4	-40°C to +85°C	64-Lead Low Profile Quad Flat Package [LQFP]	ST-64-2
AD7606BSTZ-4RL	-40°C to +85°C	64-Lead Low Profile Quad Flat Package [LQFP]	ST-64-2
EVAL-AD7606SDZ		Evaluation Board for the AD7606	
EVAL-AD7606-6SDZ		Evaluation Board for the AD7606-6	
EVAL-AD7606-4SDZ		Evaluation Board for the AD7606-4	
EVAL-SDP-CB1Z		Evaluation Controller Board	

¹ Z = RoHS Compliant Part.

² The EVAL-AD7606SDZ, EVAL-AD7606-6SDZ, and EVAL-AD7606-4SDZ can be used as standalone evaluation boards or in conjunction with the EVAL-SDP-CB1Z for evaluation/demonstration purposes.

³ The EVAL-SDP-CB1Z allows the PC to control and communicate with all Analog Devices, Inc., evaluation boards ending in the SDZ designator.

NOTES

NOTES

Looking for pricing, stock, or lifecycle information?

Click below to explore more details on WIN SOURCE:

 [View AD7606BSTZ-6RL on WIN SOURCE](#)

 [Analog Devices Inc. Information](#)

Optimize Your Supply Chain with WIN SOURCE Solutions

-  Global Sourcing Solution
-  Obsolete Management
-  Cost Control Management
-  Shortage Management
-  Alternative Solution
-  Excess Inventory Management