



**THE DATASHEET OF  
MAX4164ESD+**





# UCSP, Micropower, Single-Supply, 10V, Rail-to-Rail I/O Op Amps

MAX4162/MAX4163/MAX4164

## General Description

The MAX4162/MAX4163/MAX4164 are single/dual/quad, micropower operational amplifiers that combine an exceptional bandwidth to power consumption ratio with true rail-to-rail inputs and outputs. They consume a mere 25µA quiescent current per amplifier, yet achieve 200kHz gain-bandwidth product and are unity-gain stable while driving any capacitive load. The MAX4162/MAX4163/MAX4164 operate from either a single supply (2.5V to 10V) or dual supplies ( $\pm 1.25V$  to  $\pm 5V$ ), with an input common-mode voltage range that extends 250mV beyond either supply rail. These amplifiers use a proprietary architecture to achieve a very high input common-mode rejection ratio without the midswing nonlinearities present in other rail-to-rail op amps. This architecture also maintains high open-loop gain and output swing while driving substantial loads.

The combination of excellent bandwidth/power performance, single-supply operation, and miniature footprint makes these op amps ideal for portable equipment and other low-power, single-supply applications. The single MAX4162 is available in 8-pin SO and space-saving 5-pin SOT23 packages. The MAX4163 is available in an 8-pin ultra chip-scale package (UCSP™) and an 8-pin µMAX® or SO package. The MAX4164 is available in a 14-pin SO package.

## Applications

- |                                  |                      |
|----------------------------------|----------------------|
| Battery-Powered Devices          | Medical Instruments  |
| pH Probes                        | Ionization Detectors |
| Portable Equipment               | Cellular Phones      |
| Low-Power, Low-Voltage Equipment |                      |

## Pin Configurations

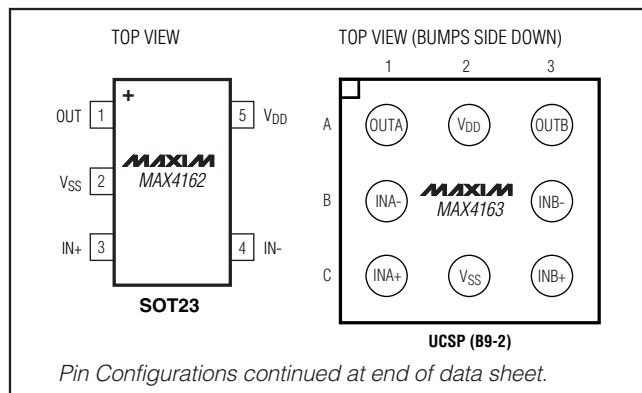

UCSP is a trademark and µMAX is a registered trademark of Maxim Integrated Products, Inc.

## Features

- ◆ UCSP Package (MAX4163)
- ◆ 1.0pA Typical Input Bias Current
- ◆ Single-Supply Operation from 2.5V to 10V
- ◆ Input Common-Mode Voltage Range Extends 250mV Beyond Either Supply Rail
- ◆ Rail-to-Rail Output Swing
- ◆ 200kHz Gain-Bandwidth Product
- ◆ 25µA Quiescent Current per Amplifier
- ◆ Excellent CMRR, PSRR, and Gain Linearity
- ◆ No Phase Reversal for Overdriven Inputs
- ◆ Unity-Gain Stable
- ◆ Stable with Any Capacitive Load
- ◆ Internally Short-Circuit Protected to Either Rail

## Ordering Information

PART	TEMP RANGE	PIN-PACKAGE	TOP MARK
MAX4162ESA+	-40°C to +85°C	8 SO	—
MAX4162EUK+	-40°C to +85°C	5 SOT23	AABX
MAX4163EBL+T*	-40°C to +85°C	8 UCSP	AAX
MAX4163ESA+	-40°C to +85°C	8 SO	—
MAX4163EUA+	-40°C to +85°C	8 µMAX	—
MAX4164ESD+	-40°C to +85°C	14 SO	—

+ Denotes a lead(Pb)-free/RoHS-compliant package.  
T = Tape and reel.

\*UCSP reliability is integrally linked to the user's assembly methods, circuit board material, and environment. Refer to the UCSP Reliability Notice in the UCSP Reliability section of this data sheet for more information.

## Typical Application Circuit

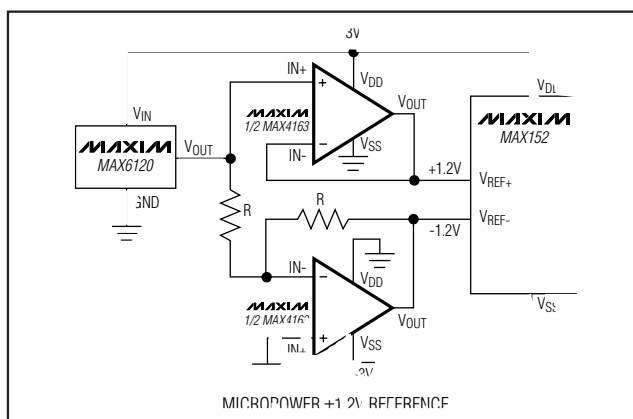

# UCSP, Micropower, Single-Supply, 10V, Rail-to-Rail I/O Op Amps

## ABSOLUTE MAXIMUM RATINGS

Supply Voltage ( $V_{DD}$ to $V_{SS}$ ).....	11V	8-Pin $\mu$ MAX (derate 4.8mW/°C above +70°C).....	387mW
IN+, IN-, OUT Voltage.....( $V_{DD} + 0.3V$ ) to ( $V_{SS} - 0.3V$ ).....		14-Pin SO (derate 12.3mW/°C above +70°C).....	987mW
Short-Circuit Duration (to either rail).....	Continuous	Operating Temperature Range.....	-40°C to +85°C
Continuous Power Dissipation ( $T_A = +70^\circ\text{C}$ )		Storage Temperature Range.....	-65°C to +150°C
5-Pin SOT23 (derate 3.9mW/°C above +70°C).....	312mW	Junction Temperature.....	+150°C
8-Pin SO (derate 7.4mW/°C above +70°C).....	588mW	Lead Temperature (soldering, 10s).....	+300°C
8-Pin UCSP (derate 4.7mW/°C above +70°C).....	379mW	Soldering Temperature (reflow, UCSP).....	+260°C

Stresses beyond those listed under "Absolute Maximum Ratings" may cause permanent damage to the device. These are stress ratings only, and functional operation of the device at these or any other conditions beyond those indicated in the operational sections of the specifications is not implied. Exposure to absolute maximum rating conditions for extended periods may affect device reliability.

## ELECTRICAL CHARACTERISTICS: 3V Operation

( $V_{DD} = 3V$ ,  $V_{SS} = 0V$ ,  $V_{CM} = V_{DD}/2$ ,  $V_{OUT} = V_{DD}/2$ ,  $R_L$  connected to  $V_{DD}/2$ ,  $T_A = -40^\circ\text{C}$  to  $+85^\circ\text{C}$ , unless otherwise noted. Typical values are at  $T_A = +25^\circ\text{C}$ .) (Note 1)

PARAMETER	SYMBOL	CONDITIONS	MIN	TYP	MAX	UNITS
Operating Voltage Range	$V_{DD}$	Inferred from PSRR test	2.5		10.0	V
Supply Current (Per Amplifier)	$I_{DD}$			25	40	$\mu\text{A}$
Input Bias Current (Note 2)	$I_B$			1.0	100	pA
Input Offset Voltage	$V_{OS}$	MAX4162	$T_A = +25^\circ\text{C}$	$\pm 0.5$	$\pm 3$	mV
			$T_A = -40^\circ\text{C}$ to $+85^\circ\text{C}$		$\pm 4$	
		MAX4163	$T_A = +25^\circ\text{C}$	$\pm 0.5$	$\pm 4$	
			$T_A = -40^\circ\text{C}$ to $+85^\circ\text{C}$		$\pm 5$	
		MAX4164	$T_A = +25^\circ\text{C}$	$\pm 0.5$	$\pm 5$	
			$T_A = -40^\circ\text{C}$ to $+85^\circ\text{C}$		$\pm 6$	
Input Offset Voltage Tempco	$TCV_{OS}$			2		$\mu\text{V}/^\circ\text{C}$
Differential Input Resistance	$R_{IN}$			>10		$\text{T}\Omega$
Input Common-Mode Voltage Range	$V_{CM}$	Inferred from CMRR test	$V_{SS} - 0.25$		$V_{DD} + 0.25$	V
Common-Mode Rejection Ratio	CMRR	$V_{CM} = (V_{SS} - 0.25V)$ to $(V_{DD} + 0.25V)$	70	100		dB
Large-Signal Voltage Gain	$A_V$	$R_L = 10\text{k}\Omega$	85	120		dB
Output Voltage Swing	$V_{OUT}$	$R_L = 10\text{k}\Omega$	$V_{DD} - V_{OH}$	30	180	mV
			$V_{OL} - V_{SS}$	30	180	
		$R_L = 100\text{k}\Omega$	$V_{DD} - V_{OH}$	3	25	
			$V_{OL} - V_{SS}$	3	25	
Output Short-Circuit Current	$I_{SC}$	To either supply rail		15		mA
Closed-Loop Output Resistance	$R_{OUT}$	$A_V = 1V/V$		0.1		$\Omega$
Power-Supply Rejection Ratio	PSRR	$V_{DD} = 2.5V$ to $10V$	80	110		dB
Gain-Bandwidth Product	GBWP			200		kHz
Phase Margin	$\phi_M$			60		degrees
Gain Margin	GM			12		dB
Total Harmonic Distortion	THD	$f = 1\text{kHz}$ , $V_{OUT} = 2V_{P-P}$ , $R_L = 100\text{k}\Omega$ , $A_V = 1V/V$		0.02		%
Slew Rate	SR			115		V/ms
Settling Time to 0.1%		$V_{OUT} = 1V$ to $2V$ step		50		$\mu\text{s}$
Turn-On Time	$t_{ON}$	$V_{DD} = 0$ to $3V$ step, $V_{IN} = V_{DD}/2$ , $A_V = 1V/V$		20		$\mu\text{s}$

# UCSP, Micropower, Single-Supply, 10V, Rail-to-Rail I/O Op Amps

MAX4162/MAX4163/MAX4164

## ELECTRICAL CHARACTERISTICS: 3V Operation (continued)

( $V_{DD} = 3V$ ,  $V_{SS} = 0V$ ,  $V_{CM} = V_{DD}/2$ ,  $V_{OUT} = V_{DD}/2$ ,  $R_L$  connected to  $V_{DD}/2$ ,  $T_A = -40^\circ C$  to  $+85^\circ C$ , unless otherwise noted. Typical values are at  $T_A = +25^\circ C$ .) (Note 1)

PARAMETER	SYMBOL	CONDITIONS	MIN	TYP	MAX	UNITS
Input Voltage-Noise Density	$e_n$	$f = 1kHz$		80		$nV/\sqrt{Hz}$
Differential Input Capacitance				0.7		pF
Input Common-Mode Capacitance				1.5		pF
Internal Charge-Pump Frequency				700		kHz
Charge-Pump Output Feedthrough				100		$\mu V_{P-P}$

## ELECTRICAL CHARACTERISTICS: 5V Operation

( $V_{DD} = 5V$ ,  $V_{SS} = 0V$ ,  $V_{CM} = V_{DD}/2$ ,  $V_{OUT} = V_{DD}/2$ ,  $R_L$  connected to  $V_{DD}/2$ ,  $T_A = -40^\circ C$  to  $+85^\circ C$ , unless otherwise noted. Typical values are at  $T_A = +25^\circ C$ .) (Note 1)

PARAMETER	SYMBOL	CONDITIONS	MIN	TYP	MAX	UNITS
Operating Voltage Range	$V_{DD}$	Inferred from PSRR test	4.5		10.0	V
Supply Current (Per Amplifier)	$I_{DD}$			25	45	$\mu A$
Input Bias Current (Note 2)	$I_B$			1.0	100	pA
Input Offset Voltage	$V_{OS}$	MAX4162	$T_A = +25^\circ C$	$\pm 0.5$	$\pm 3$	mV
			$T_A = -40^\circ C$ to $+85^\circ C$		$\pm 4$	
		MAX4163	$T_A = +25^\circ C$	$\pm 0.5$	$\pm 4$	
			$T_A = -40^\circ C$ to $+85^\circ C$		$\pm 5$	
		MAX4164	$T_A = +25^\circ C$	$\pm 0.5$	$\pm 5$	
			$T_A = -40^\circ C$ to $+85^\circ C$		$\pm 6$	
Input Offset Voltage Tempco				2		$\mu V/^\circ C$
Differential Input Resistance				$>10$		$T\Omega$
Input Common-Mode Voltage Range	$V_{CM}$	Inferred from CMRR test	$V_{SS} - 0.25$		$V_{DD} + 0.25$	V
Common-Mode Rejection Ratio	CMRR	$V_{CM} = (V_{SS} - 0.25V)$ to $(V_{DD} + 0.25V)$	70	100		dB
Large-Signal Voltage Gain	$A_V$	$R_L = 10k\Omega$	85	120		dB
Output Voltage Swing	$V_{OUT}$	$R_L = 10k\Omega$	$V_{DD} - V_{OH}$	50	300	mV
			$V_{OL} - V_{SS}$	50	300	
		$R_L = 100k\Omega$	$V_{DD} - V_{OH}$	5	40	
			$V_{OL} - V_{SS}$	5	40	
Output Short-Circuit Current	$I_{SC}$	To either supply rail		15		mA
Closed-Loop Output Resistance	$R_{OUT}$	$A_V = 1V/V$		0.1		$\Omega$
Power-Supply Rejection Ratio	PSRR	$V_{DD} = 4.5V$ to $10V$	80	110		dB
Gain-Bandwidth Product	GBWP			200		kHz
Phase Margin	$\phi_M$			60		degrees
Gain Margin	GM			12		dB

# UCSP, Micropower, Single-Supply, 10V, Rail-to-Rail I/O Op Amps

## ELECTRICAL CHARACTERISTICS: 5V Operation (continued)

( $V_{DD} = 5V$ ,  $V_{SS} = 0V$ ,  $V_{CM} = V_{DD}/2$ ,  $V_{OUT} = V_{DD}/2$ ,  $R_L$  connected to  $V_{DD}/2$ ,  $T_A = -40^\circ C$  to  $+85^\circ C$ , unless otherwise noted. Typical values are at  $T_A = +25^\circ C$ .) (Note 1)

PARAMETER	SYMBOL	CONDITIONS	MIN	TYP	MAX	UNITS
Total Harmonic Distortion	THD	$f = 1kHz$ , $V_{OUT} = 2V_{P-P}$ , $R_L = 100k\Omega$ , $A_V = 1V/V$		0.02		%
Slew Rate	SR			115		V/ms
Settling Time to 0.1%		$V_{OUT} = 1V$ to $2V$ step		70		$\mu s$
Turn-On Time	$t_{ON}$	$V_{DD} = 0$ to $3V$ step, $V_{IN} = V_{DD}/2$ , $A_V = 1V/V$		40		$\mu s$
Input Voltage-Noise Density	$e_n$	$f = 1kHz$		80		$nV/\sqrt{Hz}$
Differential Input Capacitance				0.7		pF
Input Common-Mode Capacitance				1.5		pF
Internal Charge-Pump Frequency				700		kHz
Charge-Pump Output Feedthrough				100		$\mu V_{P-P}$

**Note 1:** All device specifications are 100% tested at  $T_A = +25^\circ C$ . Limits over the extended temperature range are guaranteed by design, not production tested.

**Note 2:** Input bias current guaranteed by design, not production tested.

## Typical Operating Characteristics

( $V_{DD} = 5V$ ,  $V_{SS} = 0V$ ,  $V_{CM} = V_{DD}/2$ ,  $T_A = +25^\circ C$ , unless otherwise noted.)

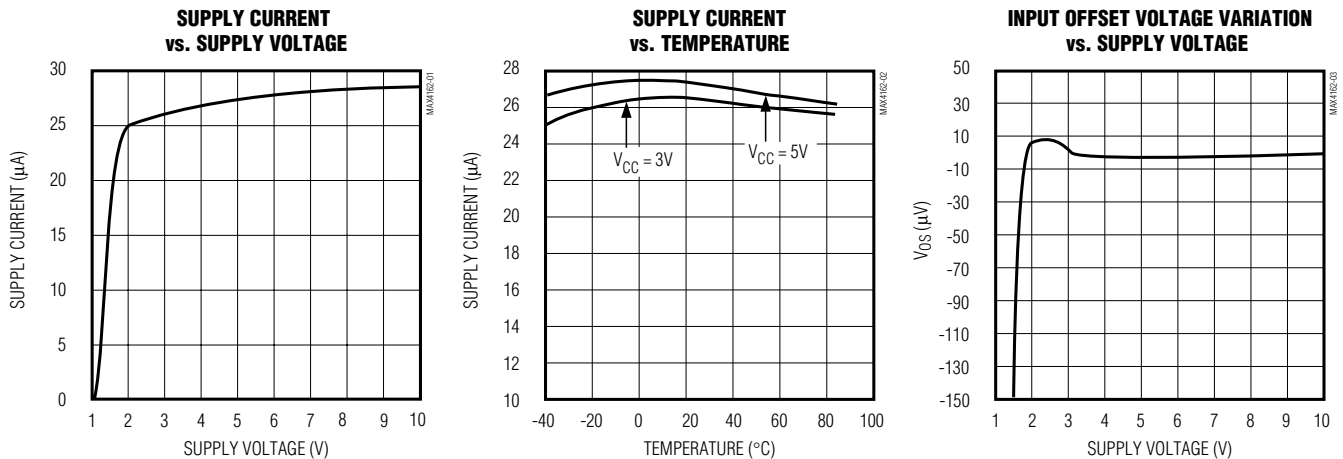

# UCSP, Micropower, Single-Supply, 10V, Rail-to-Rail I/O Op Amps

## Typical Operating Characteristics (continued)

( $V_{DD} = 5V$ ,  $V_{SS} = 0V$ ,  $V_{CM} = V_{DD}/2$ ,  $T_A = +25^\circ C$ , unless otherwise noted.)

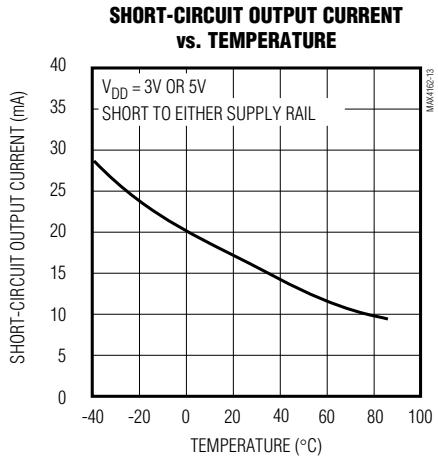
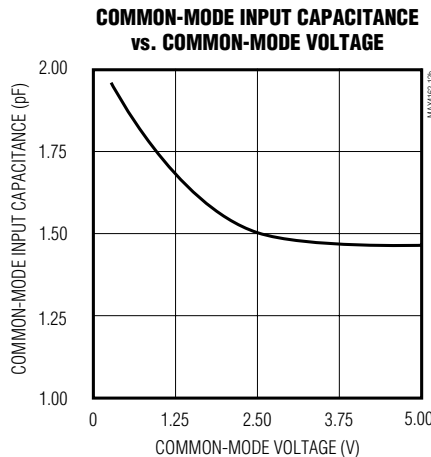
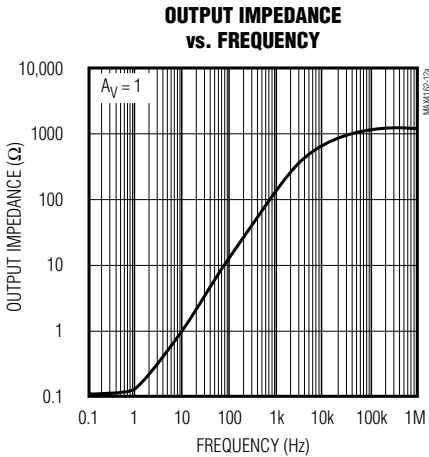
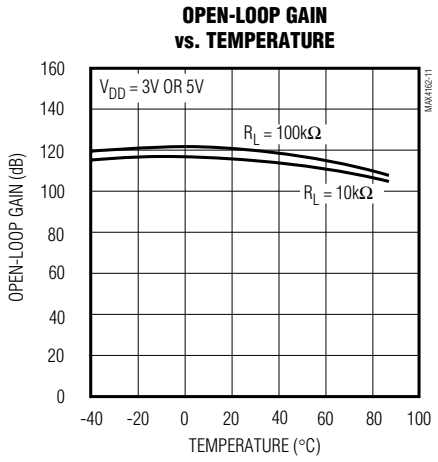
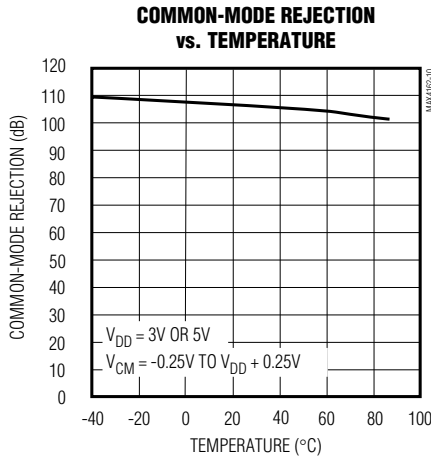
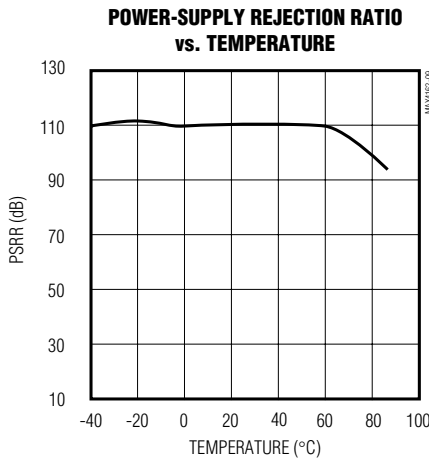
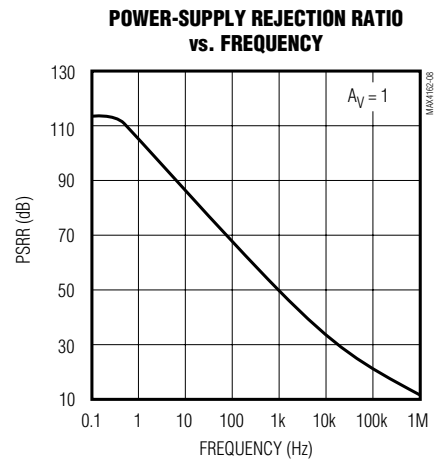
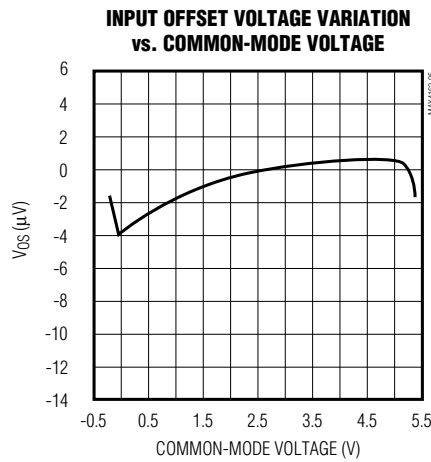
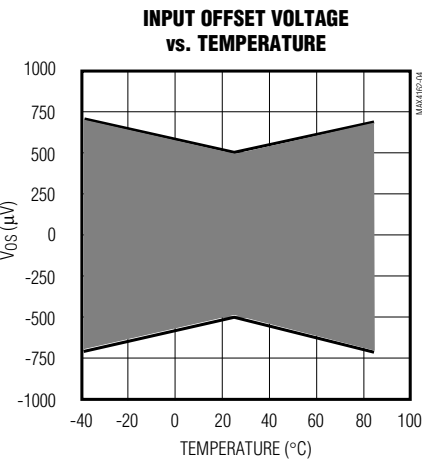

MAX4162/MAX4163/MAX4164

# UCSP, Micropower, Single-Supply, 10V, Rail-to-Rail I/O Op Amps

## Typical Operating Characteristics (continued)

( $V_{DD} = 5V$ ,  $V_{SS} = 0V$ ,  $V_{CM} = V_{DD}/2$ ,  $T_A = +25^\circ C$ , unless otherwise noted.)

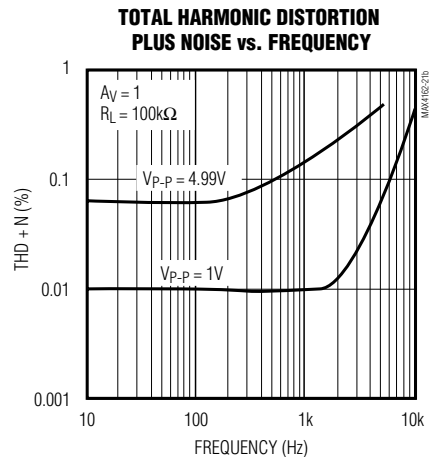
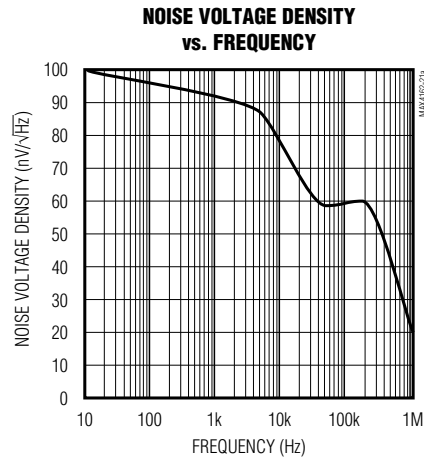
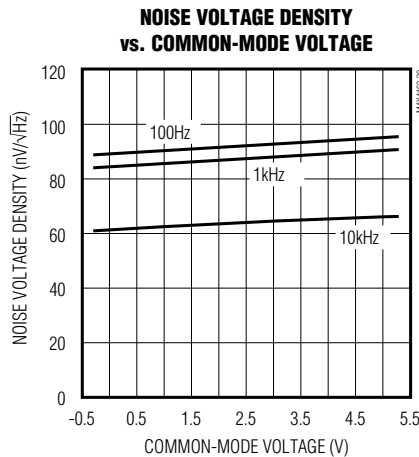
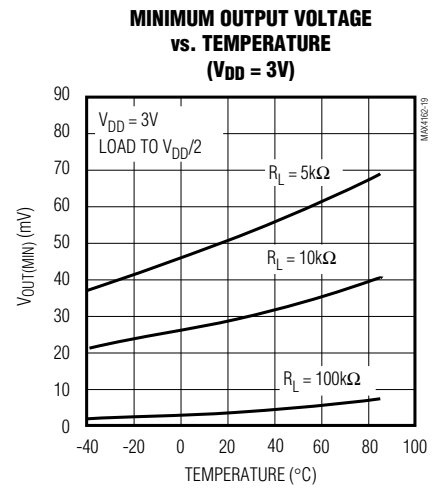
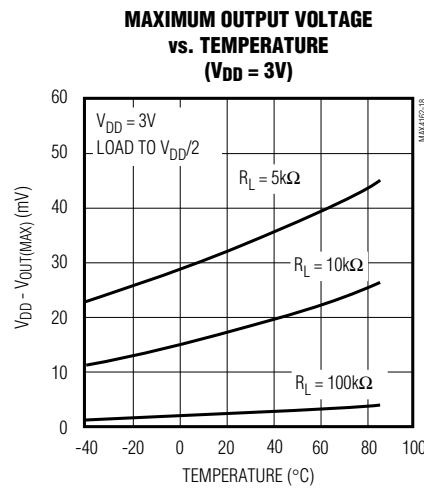
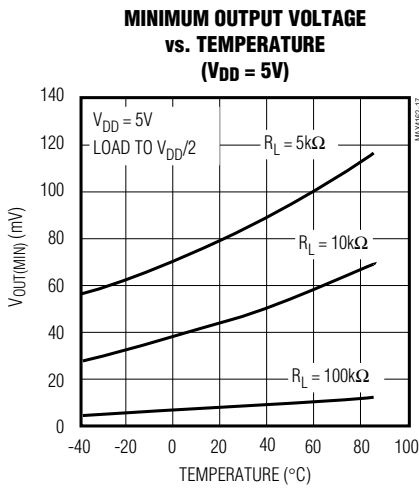
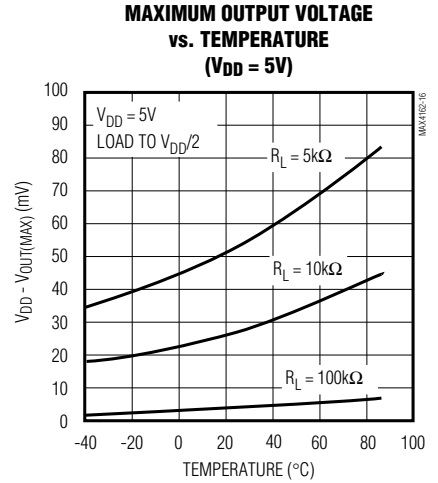
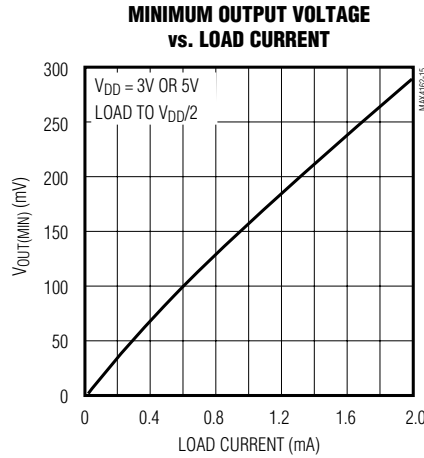
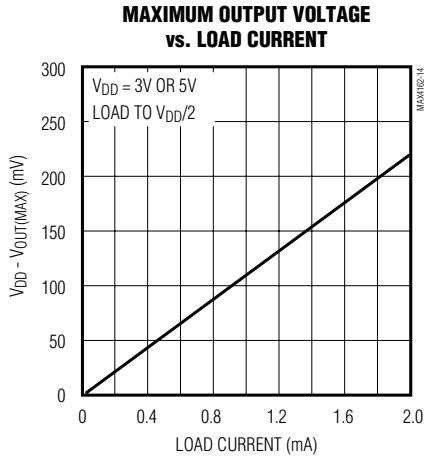

# UCSP, Micropower, Single-Supply, 10V, Rail-to-Rail I/O Op Amps

## Typical Operating Characteristics (continued)

( $V_{DD} = 5V$ ,  $V_{SS} = 0V$ ,  $V_{CM} = V_{DD}/2$ ,  $T_A = +25^\circ C$ , unless otherwise noted.)

MAX4162/MAX4163/MAX4164

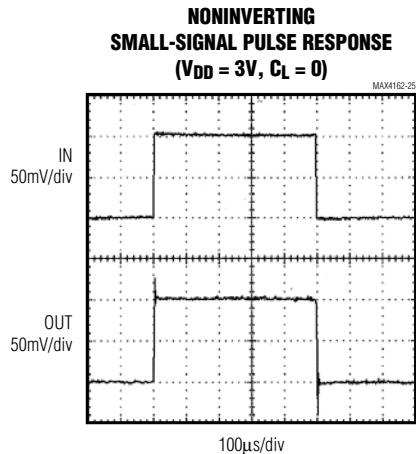
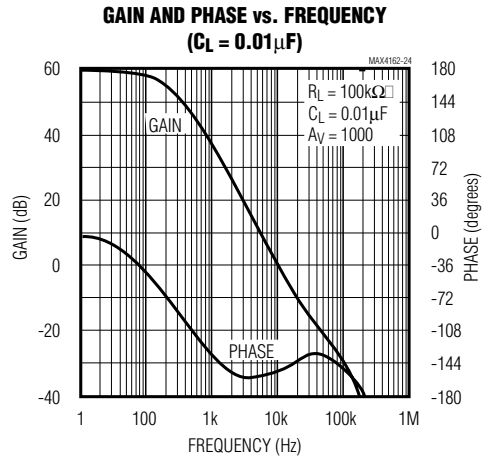
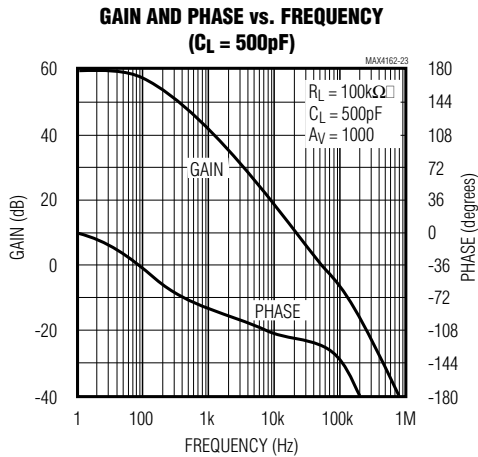
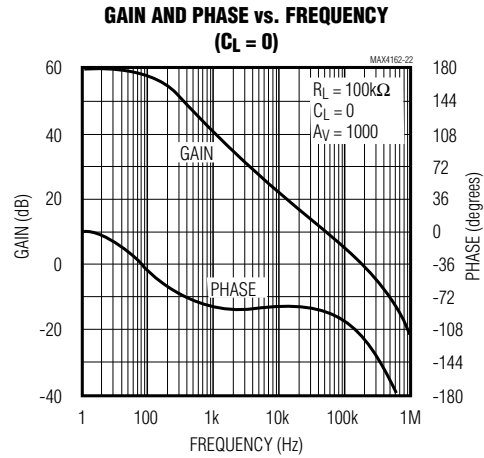
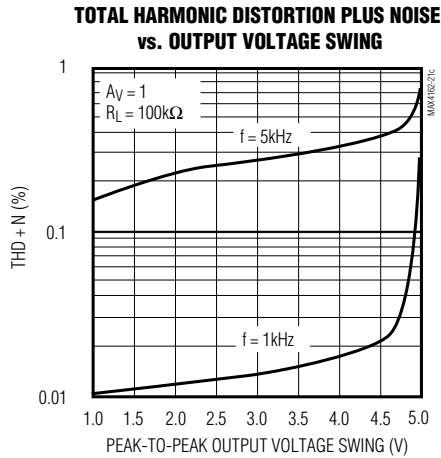

$V_{DD} = 3V$ ,  $V_{IN} = 100mV$ ,  $R_L = 100k\Omega$  to  $V_{DD}/2$ ,  $C_L = 0$

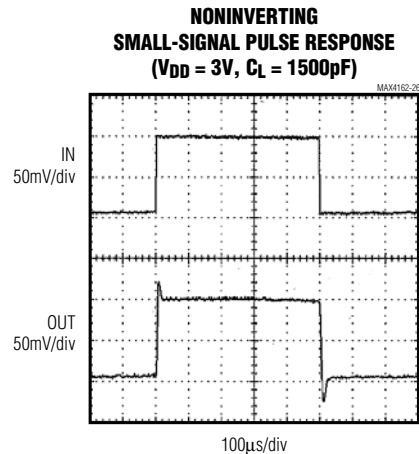

$V_{DD} = 3V$ ,  $V_{IN} = 100mV$ ,  $R_L = 100k\Omega$  to  $V_{DD}/2$ ,  $C_L = 1500pF$

# UCSP, Micropower, Single-Supply, 10V, Rail-to-Rail I/O Op Amps

## Typical Operating Characteristics (continued)

( $V_{DD} = 5V$ ,  $V_{SS} = 0V$ ,  $V_{CM} = V_{DD}/2$ ,  $T_A = +25^\circ C$ , unless otherwise noted.)

**NONINVERTING  
SMALL-SIGNAL PULSE RESPONSE  
( $V_{DD} = 5V$ ,  $C_L = 0$ )**

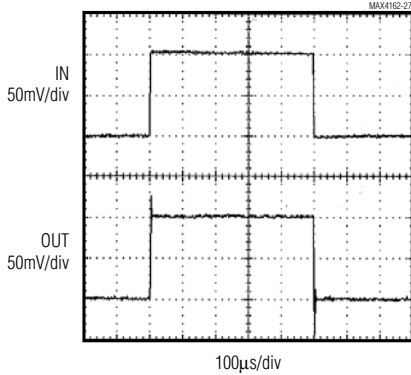

$V_{DD} = 5V$ ,  $V_{IN} = 100mV$ ,  $R_L = 100k\Omega$  to  $V_{DD}/2$ ,  $C_L = 0$

**NONINVERTING  
SMALL-SIGNAL PULSE RESPONSE  
( $V_{DD} = 5V$ ,  $C_L = 1500pF$ )**

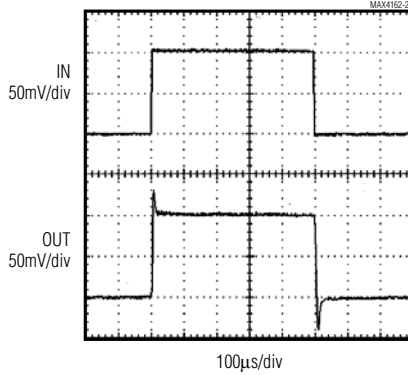

$V_{DD} = 5V$ ,  $V_{IN} = 100mV$ ,  $R_L = 100k\Omega$  to  $V_{DD}/2$ ,  $C_L = 1500pF$

**NONINVERTING  
LARGE-SIGNAL PULSE RESPONSE  
( $V_{DD} = 3V$ ,  $C_L = 0$ )**

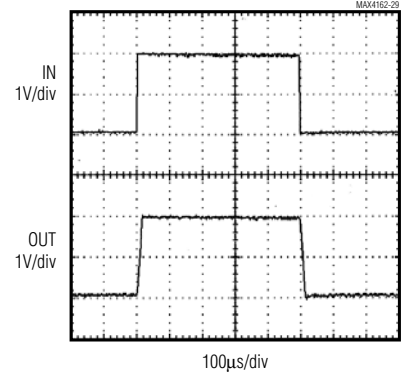

$V_{DD} = 3V$ ,  $V_{IN} = 2V$ ,  $R_L = 100k\Omega$  to  $V_{DD}/2$ ,  $C_L = 0$

**NONINVERTING  
LARGE-SIGNAL PULSE RESPONSE  
( $V_{DD} = 3V$ ,  $C_L = 1500pF$ )**

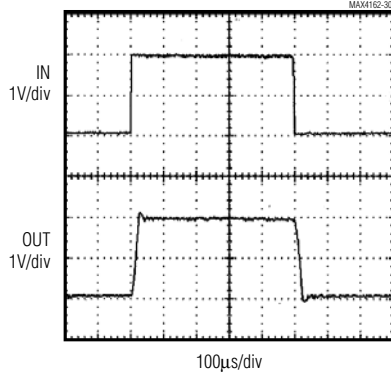

$V_{DD} = 3V$ ,  $V_{IN} = 2V$ ,  $R_L = 100k\Omega$  to  $V_{DD}/2$ ,  $C_L = 1500pF$

**NONINVERTING  
LARGE-SIGNAL PULSE RESPONSE  
( $V_{DD} = 5V$ ,  $C_L = 0$ )**

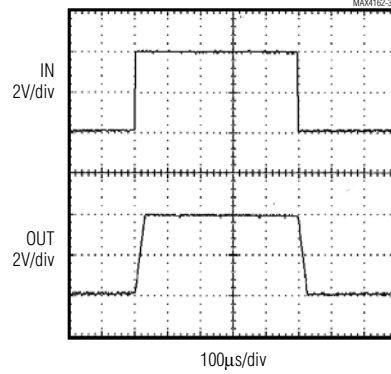

$V_{DD} = 5V$ ,  $V_{IN} = 4V$ ,  $R_L = 100k\Omega$  to  $V_{DD}/2$ ,  $C_L = 0$

# UCSP, Micropower, Single-Supply, 10V, Rail-to-Rail I/O Op Amps

## Typical Operating Characteristics (continued)

( $V_{DD} = 5V$ ,  $V_{SS} = 0V$ ,  $V_{CM} = V_{DD}/2$ ,  $T_A = +25^\circ C$ , unless otherwise noted.)

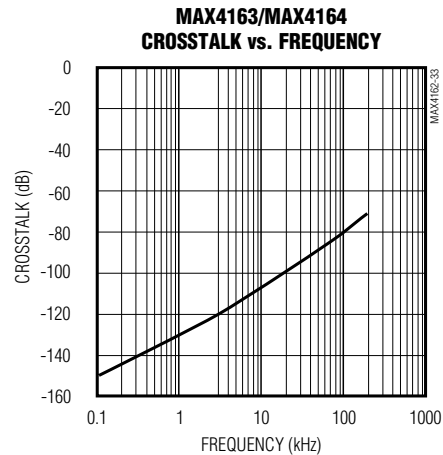
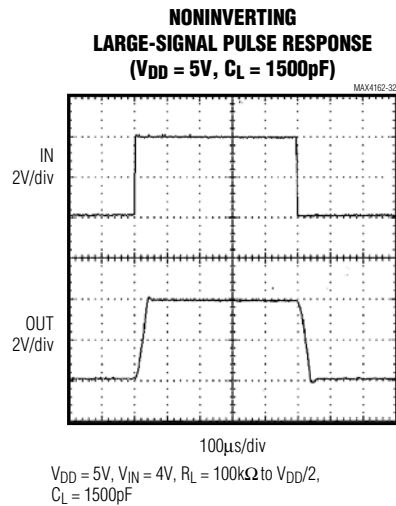

## Pin Description

PIN					NAME	FUNCTION
MAX4162		MAX4163		MAX4164		
SO	SOT23	SO/ $\mu$ MAX	UCSP	SO		
1, 5, 8	—	—	—	—	N.C.	No Connection. Not internally connected.
2	4	—	—	—	IN-	Amplifier Inverting Input
3	3	—	—	—	IN+	Amplifier Noninverting Input
4	2	4	C2	11	$V_{SS}$	Negative Power Supply
6	1	—	—	—	OUT	Amplifier Output
7	5	8	A2	4	$V_{DD}$	Positive Power Supply
—	—	1	A1	1	OUTA	Amplifier A Output
—	—	2	B1	2	INA-	Amplifier A Inverting Input
—	—	3	C1	3	INA+	Amplifier A Noninverting Input
—	—	5	C3	5	INB+	Amplifier B Noninverting Input
—	—	6	B3	6	INB-	Amplifier B Inverting Input
—	—	7	A3	7	OUTB	Amplifier B Output
—	—	—	—	8	OUTC	Amplifier C Output
—	—	—	—	9	INC-	Amplifier C Inverting Input
—	—	—	—	10	INC+	Amplifier C Noninverting Input
—	—	—	—	12	IND+	Amplifier D Noninverting Input
—	—	—	—	13	IND-	Amplifier D Inverting Input
—	—	—	—	14	OUTD	Amplifier D Output

MAX4162/MAX4163/MAX4164

# UCSP, Micropower, Single-Supply, 10V, Rail-to-Rail I/O Op Amps

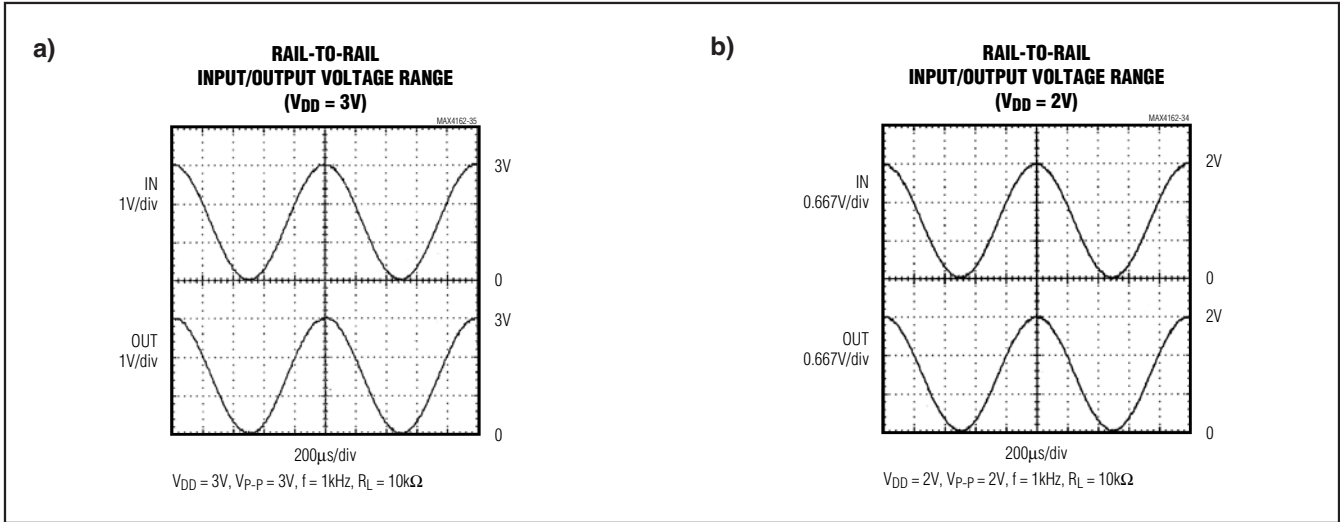

Figure 1. Rail-to-Rail I/O: a)  $V_{DD} = 3V$ ; b)  $V_{DD} = 2V$

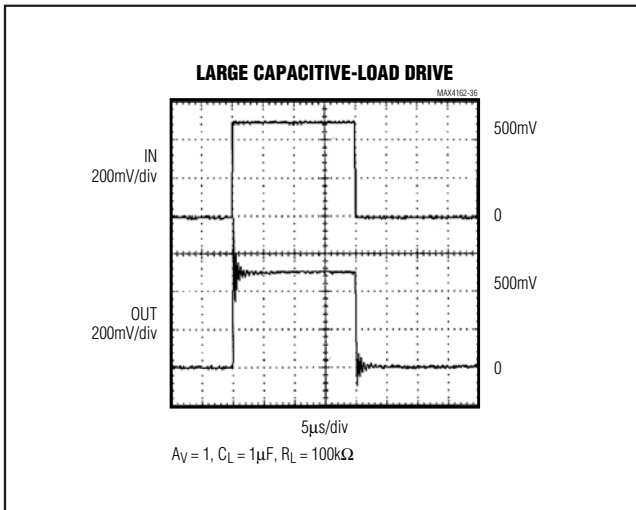

Figure 2. Large Capacitive-Load Drive

## Applications Information

### Rail-to-Rail Inputs and Outputs

The MAX4162/MAX4163/MAX4164 input common-mode range extends 250mV beyond each of the supply rails, providing a substantial increase in dynamic range over other op amps (even many of those referred to as rail-to-rail). Although the minimum operating voltage is specified at 2.5V, the devices typically provide full rail-to-rail operation below 2.0V (Figure 1). These amplifiers do not

suffer from midswing common-mode-rejection degradation or crossover nonlinearity often encountered in other rail-to-rail op amps. Extremely low, 1.0pA input bias current makes these devices ideal for applications such as pH probes, electrometers, and ionization detectors. They are also protected against phase reversal (inferred from CMRR test) and latchup for input signals extending beyond the supply rails. The output stage achieves a lower output impedance than traditional rail-to-rail output stages, providing an output voltage range that typically swings within 150mV of the supply rails for 1mA loads. This architecture also maintains high open-loop gain and output swing while driving substantial loads.

### Output Loading and Stability

These devices drive 1mA loads to within 150mV of the supply rails while consuming only 25µA of quiescent current. Internal compensation allows these amplifiers to remain unity-gain stable while driving any capacitive load (Figure 2).

### Internal Charge Pump

An internal charge pump provides two internal supplies typically 2V beyond each rail. These internal rails allow the MAX4162/MAX4163/MAX4164 to achieve true rail-to-rail inputs and outputs, while providing excellent common-mode rejection, power-supply rejection ratios, and gain linearity.

These charge pumps require no external components, and in most applications are entirely transparent to the user. Two characteristics may be visible to the user, depending on the application:

# UCSP, Micropower, Single-Supply, 10V, Rail-to-Rail I/O Op Amps

MAX4162/MAX4163/MAX4164

- 1) The on-board charge pumps generate a small amount of 700kHz switching noise at the op amp's output. The amplitude of this noise is typically 100 $\mu$ Vp-p. The noise is **not** referred to the input, and is independent of amplifier gain. The charge-pump switching frequency is well beyond the amplifier's 200kHz bandwidth, and is therefore unnoticeable in most applications.
- 2) The charge pumps typically require up to 20 $\mu$ s on power-up to fully energize the internal supply rails (Figure 3).

### Power Supplies and Layout

The MAX4162/MAX4163/MAX4164 are guaranteed to operate from a single 2.5V to 10.0V power supply, but full rail-to-rail operation typically extends below 2V. For single-supply operation, bypass the power supply with a 1 $\mu$ F capacitor in parallel with a 0.1 $\mu$ F ceramic capacitor. If operating from dual supplies, bypass each supply to ground.

Good layout improves performance by decreasing the amount of stray capacitance at the op amp's inputs and output. To decrease stray capacitance, minimize both trace and external component lead lengths, and place external components close to the op amp's pins.

### UCSP Package Consideration

For general UCSP package information and PC layout considerations, please refer to the Maxim Application Note (Wafer-Level Ultra-Chip-Board-Scale-Package).

### UCSP Reliability

The UCSP represents a unique packaging form factor that may not perform equally to a packaged product through traditional mechanical reliability tests. UCSP reliability is integrally linked to the user's assembly methods, circuit board material, and usage environment. The user should closely review these areas when considering use of a UCSP. Performance through operating life test and moisture resistance remains uncompromised as it is primarily determined by the wafer-fabrication process. Mechanical stress performance is a greater consideration for a UCSP package. UCSPs are attached through direct solder contact to the user's PC board, foregoing the inherent stress relief of a packaged product lead frame. Solder joint contact integrity must be considered.

Table 1 shows the testing done to characterize the UCSP reliability performance. In conclusion, the UCSP is capable of performing reliably through environmental stresses as indicated by the results in the table. Additional usage data and recommendations are detailed in the UCSP application note, which can be found on Maxim's website at [www.maxim-ic.com](http://www.maxim-ic.com).

**Table 1. Reliability Test Data**

TEST	CONDITIONS	DURATION	NO. OF FAILURES PER SAMPLE SIZE
Temperature Cycle	-35°C to +85°C, -40°C to +100°C	150 cycles, 900 cycles	0/10, 0/200
Operating Life	T <sub>A</sub> = +70°C	240h	0/10
Moisture Resistance	-20°C to +60°C, 90% RH	240h	0/10
Low-Temperature Storage	-20°C	240h	0/10
Low-Temperature Operational	-10°C	24h	0/10
Solderability	8h steam age	—	0/15
ESD	±2000V, Human Body Model	—	0/5
High-Temperature Operating Life	T <sub>J</sub> = +150°C	168h	0/45

# UCSP, Micropower, Single-Supply, 10V, Rail-to-Rail I/O Op Amps

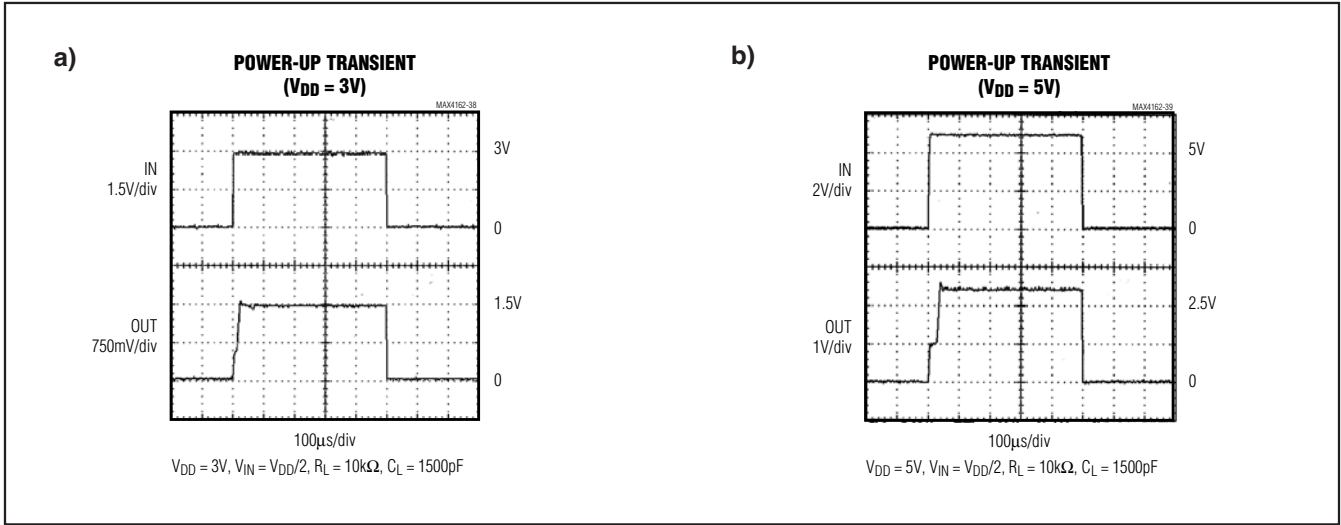
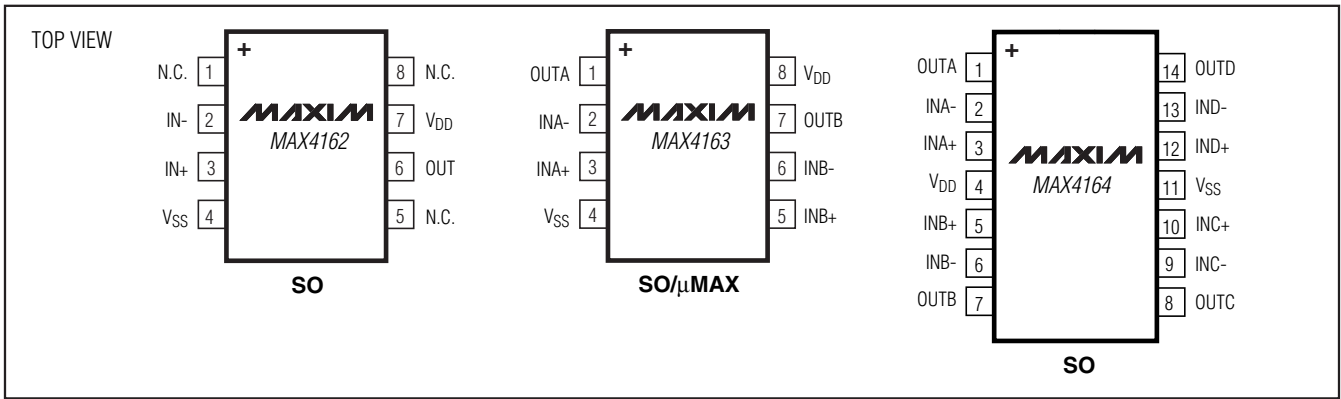

Figure 3. Power-Up Transient: a)  $V_{DD} = 3V$ ; b)  $V_{DD} = 5V$

## Pin Configurations (continued)



### Chip Information

PROCESS: BiCMOS

### Package Information

For the latest package outline information and land patterns, go to [www.maxim-ic.com/packages](http://www.maxim-ic.com/packages). Note that a "+", "#", or "-" in the package code indicates RoHS status only. Package drawings may show a different suffix character, but the drawing pertains to the package regardless of RoHS status.

PACKAGE TYPE	PACKAGE CODE	DOCUMENT NO.
8 SO	S8-2, S8-4	<a href="#">21-0041</a>
5 SOT23	U5-1	<a href="#">21-0057</a>
8 UCSP	B9-5	<a href="#">21-0093</a>
8 µMAX	U8-1	<a href="#">21-0036</a>
14 SO	S14M-5	<a href="#">21-0041</a>

# UCSP, Micropower, Single-Supply, 10V, Rail-to-Rail I/O Op Amps

## Revision History

REVISION NUMBER	REVISION DATE	DESCRIPTION	PAGES CHANGED
2	5/09	Changed operating supply voltage from 2.7V to 2.5V	1, 2, 3, 10, 11
3	1/10	Updated PSRR condition for 5V operation, added lead-free designation to <i>Ordering Information</i> , and added UCSP soldering temperature	1-9, 12

MAX4162/MAX4163/MAX4164

Maxim cannot assume responsibility for use of any circuitry other than circuitry entirely embodied in a Maxim product. No circuit patent licenses are implied. Maxim reserves the right to change the circuitry and specifications without notice at any time.

Maxim Integrated Products, 120 San Gabriel Drive, Sunnyvale, CA 94086 408-737-7600 \_\_\_\_\_ 13

## Looking for pricing, stock, or lifecycle information?

Click below to explore more details on WIN SOURCE:

 [View MAX4164ESD+](#) on WIN SOURCE

 [Maxim Integrated](#) Information

## Optimize Your Supply Chain with WIN SOURCE Solutions

-  Global Sourcing Solution
-  Obsolete Management
-  Cost Control Management
-  Shortage Management
-  Alternative Solution
-  Excess Inventory Management