



**THE DATASHEET OF  
SPA-1118Z**





RFMD Green, RoHS Compliant, Pb-Free (Z Part Number)  
Package: ESOP 8

### Product Description

RFMD's SPA-1118 is a high efficiency GaAs Heterojunction Bipolar Transistor (HBT) amplifier housed in a low-cost surface-mountable plastic package. These HBT amplifiers are fabricated using molecular beam epitaxial growth technology which produces reliable and consistent performance from wafer to wafer and lot to lot. This product is specifically designed for use as a driver amplifier for infrastructure equipment in the 850MHz band. Its high linearity makes it an ideal choice for wireless data and digital applications.

#### Optimum Technology Matching® Applied

- GaAs HBT
- GaAs MESFET
- InGaP HBT
- SiGe BiCMOS
- Si BiCMOS
- SiGe HBT
- GaAs pHEMT
- Si CMOS
- Si BJT
- GaN HEMT
- RF MEMS

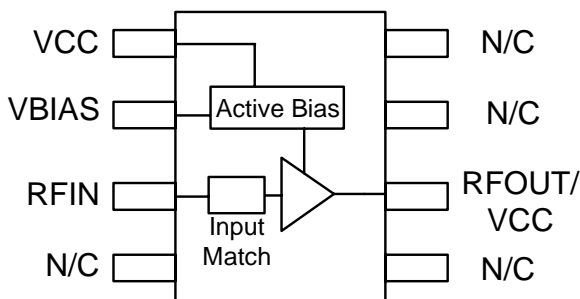

### Features

- High Linearity Performance
- +21dBm IS-95 Channel Power at -55dBc ACP
- +48dBm OIP3 Typ.
- On-Chip Active Bias Control
- Patented High Reliability GaAs HBT Technology
- Surface-Mountable Plastic Package

### Applications

- Multi-Carrier Applications
- AMPS, ISM Applications

Parameter	Specification			Unit	Condition
	Min.	Typ.	Max.		
Frequency of Operation	810		960	MHz	
Output Power at 1dB Compression		29.5		dBm	
Adjacent Channel Power		-57.0	-54.0	dBc	IS-95 at 880MHz, ±885 KHz, P <sub>OUT</sub> =21dBm
Small Signal Gain	16.2	17.2	18.2	dB	880MHz
Input VSWR		1.5:1			
Output Third Order Intercept Point		48.0		dBm	Power out per tone=+14dBm
Noise Figure		7.5		dB	
Device Current	275	310	330	mA	
Device Voltage	4.75	5.0	5.25	V	
Thermal Resistance (junction-lead)		35		°C/W	T <sub>L</sub> =85°C

Test Conditions: Z<sub>0</sub>=50Ω V<sub>CC</sub>=5V Temp=25°C

## Absolute Maximum Ratings

Parameter	Rating	Unit
Max Supply Current ( $I_{CC}$ ) at $V_{CC}$ typ.	750	mA
Max Device Voltage ( $V_{CC}$ ) at $I_{CC}$ typ.	6.0	V
Max RF Input Power	24	dBm
Max Junction Temp ( $T_J$ )	+160	°C
Max Storage Temp	+150	°C
MSL	1	



**Caution!** ESD sensitive device.

Exceeding any one or a combination of the Absolute Maximum Rating conditions may cause permanent damage to the device. Extended application of Absolute Maximum Rating conditions to the device may reduce device reliability. Specified typical performance or functional operation of the device under Absolute Maximum Rating conditions is not implied.

RoHS status based on EU Directive 2002/95/EC (at time of this document revision).

The information in this publication is believed to be accurate and reliable. However, no responsibility is assumed by RF Micro Devices, Inc. ("RFMD") for its use, nor for any infringement of patents, or other rights of third parties, resulting from its use. No license is granted by implication or otherwise under any patent or patent rights of RFMD. RFMD reserves the right to change component circuitry, recommended application circuitry and specifications at any time without prior notice.

Operation of this device beyond any one of these limits may cause permanent damage. For reliable continuous operation, the device voltage and current must not exceed the maximum operating values specified in the table on page one.

Bias Conditions should also satisfy the following expression:

$$I_D V_D < (T_J - T_L) / R_{TH, J-1}$$

## 850MHz to 950MHz Application Circuit Data, $I_{CC}=320\text{mA}$ , $V_{CC}=5\text{V}$

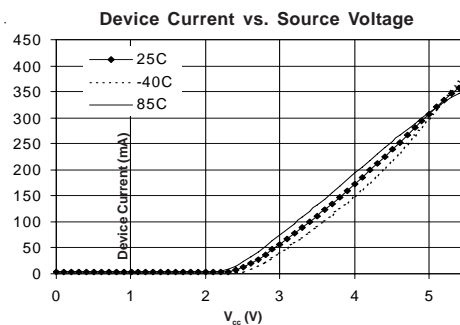
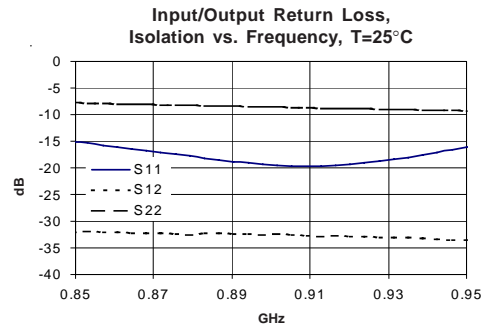
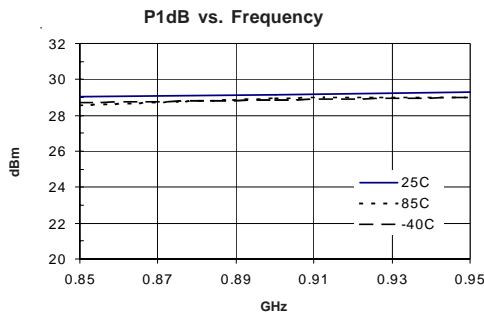
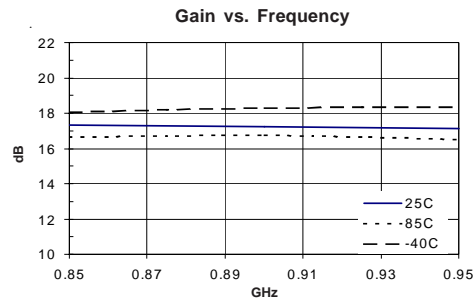
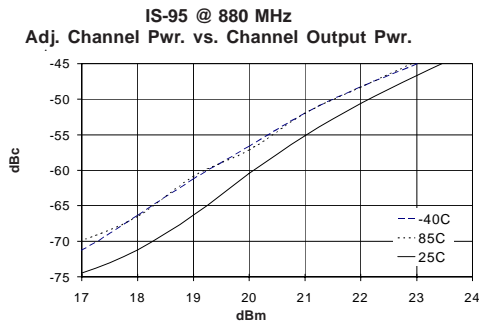

Pin	Function	Description
1	VCC	Supply voltage for the active bias network. Bypassing in the appropriate location as shown on the application schematic is required for optimum RF performance.
2	VBIAS	Bias control pin for the active bias network. Device current is set by the current into this pin. Recommended configuration is shown in the application schematic. Bypassing in the appropriate location as shown on the application schematic is required for optimum RF performance.
3	RF IN	RF input pin. This pin requires the use of an external DC-blocking capacitor chosen for the frequency of operation.
4, 5	NC	No connection.
6	RF OUT/VCC	RF output and bias pin. Bias should be supplied to this pin through an external RF choke. Because DC biasing is present on this pin a DC-blocking capacitor should be used in most applications. The supply side of the bias network should be well bypassed. An output matching network is necessary for optimum performance.
7, 8	NC	No connection.
EPAD	GND	Exposed area on the bottom side of the package needs to be soldered to the ground plane of the board for thermal and RF performance. Several vias should be located under the EPAD as shown in the recommended land pattern.

**Recommended Land Pattern**

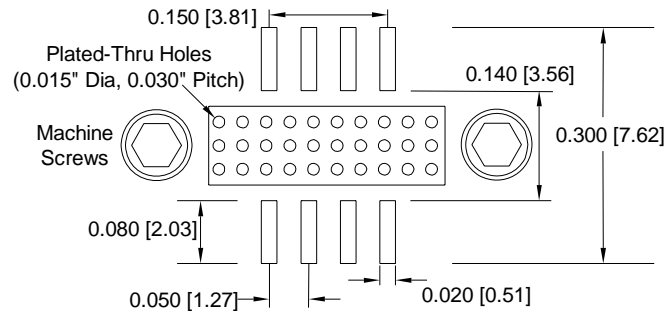

**Note:** DIMENSIONS ARE IN INCHES [MM]

**Part Identification.**

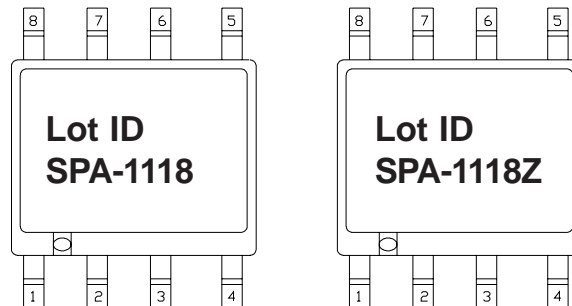

## Package Drawing

Dimensions in inches (millimeters)

Refer to drawing posted at [www.rfmd.com](http://www.rfmd.com) for tolerances.

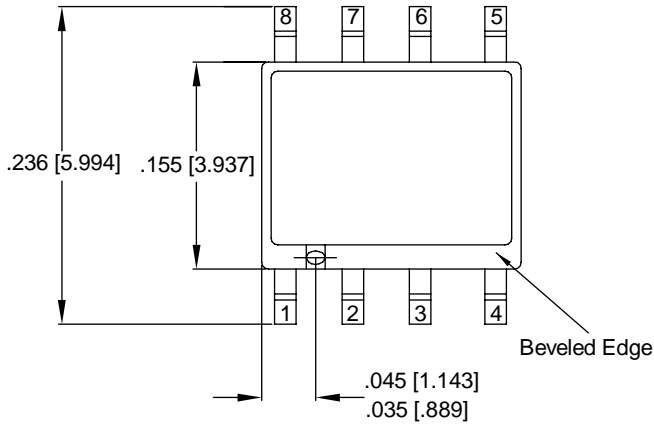

TOP VIEW

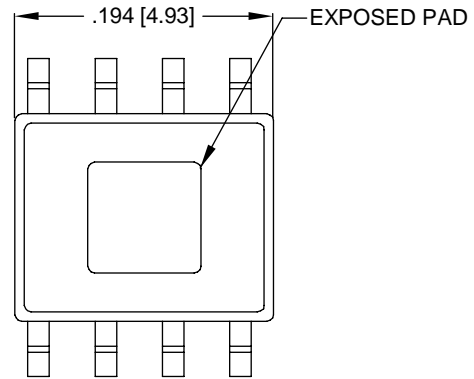

BOTTOM VIEW

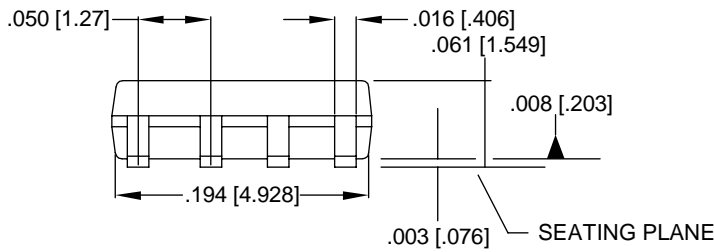

SIDE VIEW

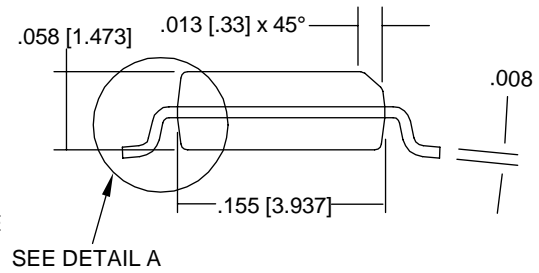

END VIEW

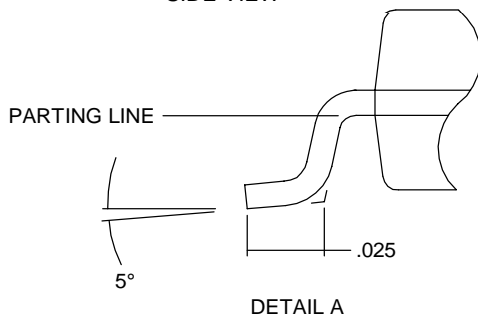

DETAIL A

**850 MHz to 950 MHz Application Schematic**

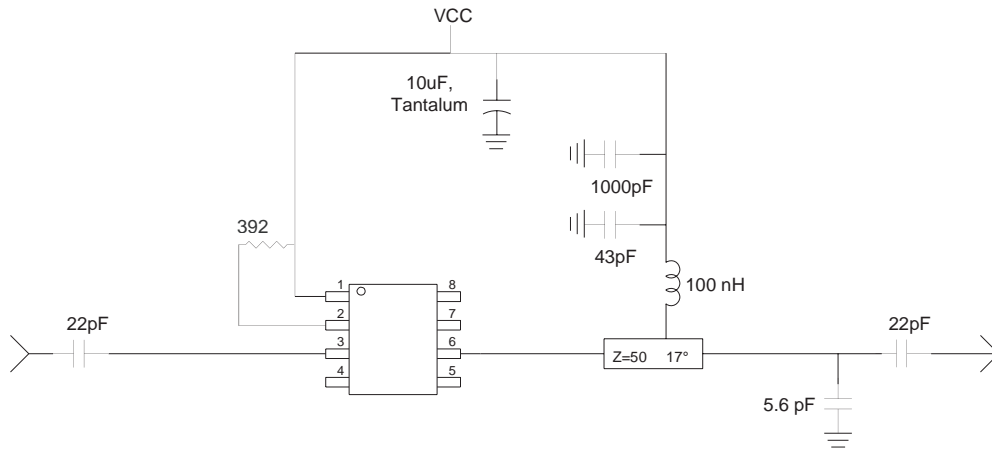

**Evaluation Board Layout**

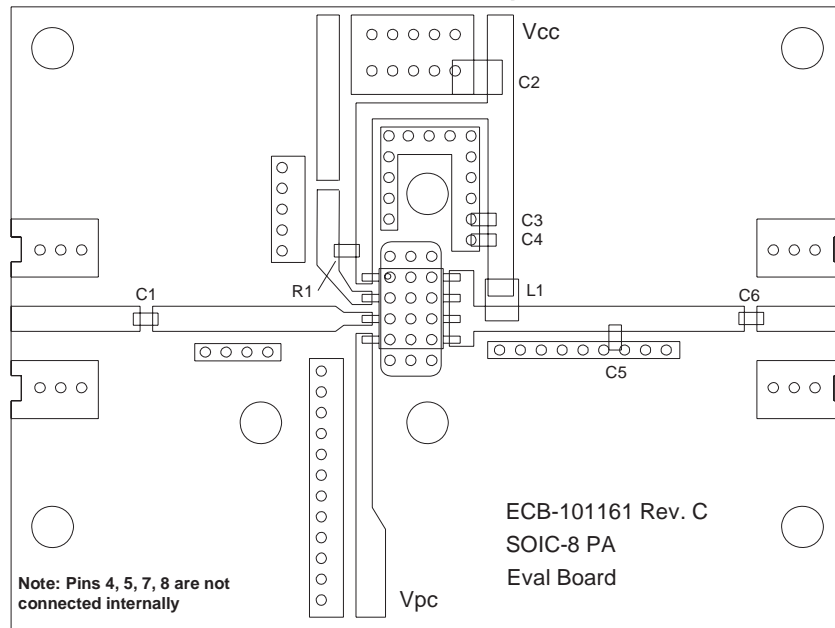

Ref. Des.	Value	Part Number
C1, C6	22 pF, 5%	Rohm MCH18 series
C2	10 uF, 10%	AVX TAJB 106K020R
C3	1000 pF, 5%	Rohm MCH18 series
C4	43 pF, 5%	Rohm MCH18 series
C5	5.6 pF, ±0.5 pF	Rohm MCH18 series
L1	100 nH, 5%	Coilcraft 1008HQ series
R1	392Ω, 1%	Rohm MCR03 series

### Ordering Information

Part Number	Reel Size	Devices/Reel
SPA-1118	7"	500
SPA-1118Z	7"	500

## Looking for pricing, stock, or lifecycle information?

Click below to explore more details on WIN SOURCE:

- ⊖ [View SPA-1118Z on WIN SOURCE](#)
- ⊖ [RF Micro Devices Information](#)

## Optimize Your Supply Chain with WIN SOURCE Solutions

- ✓ Global Sourcing Solution
- ✓ Obsolete Management
- ✓ Cost Control Management
- ✓ Shortage Management
- ✓ Alternative Solution
- ✓ Excess Inventory Management