



THE DATASHEET OF MAX973CSA+T





Ultra-Low-Power, Open-Drain, Single/Dual-Supply Comparators

General Description

The MAX971–MAX974 and MAX981–MAX984 single/dual/quad low-voltage comparators feature the lowest power consumption available. These micropower devices draw less than 4 μ A supply current over temperature (MAX971/MAX972/MAX981/MAX982), and include an internal 1.182V \pm 1% (MAX971/MAX973/MAX974) or \pm 2% (MAX981–MAX984) voltage reference and programmable hysteresis.

Ideal for 3V or 5V single-supply applications, these devices operate from a single 2.5V to 11V supply (or \pm 1.25V to \pm 5.5V dual supplies), and each comparator's input voltage ranges from the negative supply rail to within 1.3V of the positive supply.

The single MAX971/MAX981 and the dual MAX973/MAX982/MAX983 provide a unique, simple method for adding hysteresis without feedback or complicated equations, simply by using the HYST pin plus two resistors.

The MAX971–MAX974 and MAX981–MAX984's open-drain outputs permit wire-ORed configurations. Thanks to an 11V output range and separate GND pin for the output transistor (MAX971/MAX974, MAX981/MAX984), these devices are ideal for level translators and bipolar to single-ended converters. For similar devices with complementary output stages, see the MAX921–MAX924 (1% reference) and the MAX931–MAX934 (2% reference).

PART	INTERNAL PRECISION REFERENCE	COMPARATORS PER PACKAGE	INTERNAL HYSTERESIS	PACKAGE
MAX971	1%	1	Yes	8-Pin DIP/SO/ μ MAX
MAX972	None	2	No	8-Pin UCSP/DIP/SO/ μ MAX
MAX973	1%	2	Yes	8-Pin DIP/SO/ μ MAX
MAX974	1%	4	No	16-Pin DIP/SO
MAX981	2%	1	Yes	8-Pin DIP/SO/ μ MAX
MAX982	2%	2	Yes	8-Pin DIP/SO/ μ MAX
MAX983	2%	2	Yes	8-Pin DIP/SO/ μ MAX
MAX984	2%	4	No	16-Pin DIP/SO

Features

- ◆ Available in Ultra-Small Packages:
 - UCSP™ (MAX972)
 - μ MAX (MAX9_1/MAX9_2/MAX9_3)
- ◆ Ultra-Low Quiescent Current (4 μ A, max) Over Extended Temp Range (MAX971/MAX981)
- ◆ Power Supplies:
 - Single 2.5V to 11V
 - Dual \pm 1.25V to \pm 5.5V
- ◆ Input Voltage Range Includes Negative Supply
- ◆ Internal Bandgap Reference
 - 1.182V \pm 1% (MAX97_)
 - 1.182V \pm 2% (MAX98_)
- ◆ 12 μ s Propagation Delay (10mV Overdrive)
- ◆ Output Has Separate GND Pin (MAX9_1/MAX9_4)

Applications

Battery-Powered Systems	Window Comparators
Threshold Detectors	Level Translators
	Oscillator Circuits

Ordering Information

PART	TEMP RANGE	PIN-PACKAGE
MAX971CPA	0°C to +70°C	8 Plastic Dip
MAX971CSA	0°C to +70°C	8 SO
MAX971CUA	0°C to +70°C	8 μ MAX

Ordering Information continued at end of data sheet.

Typical Operating Circuit



UCSP is a trademark of Maxim Integrated Products, Inc.



Ultra-Low-Power, Open-Drain, Single/Dual-Supply Comparators

ABSOLUTE MAXIMUM RATINGS

V+ to V-, V+ to GND, GND to V-.....	-0.3V, +12V	8-Pin Plastic DIP (derate 9.09mW/°C above +70°C) ...	727mW
Inputs		8-Pin SO (derate 5.88mW/°C above +70°C).....	471mW
Current: IN+, IN-, HYST.....	20mA	8-Pin μMAX (derate 4.1mW/°C above +70°C).....	330mW
Voltage: IN+, IN-, HYST.....	(V+ + 0.3V) to (V- - 0.3V)	16-Pin Plastic DIP (derate 10.53mW/°C above +70°C)..	842mW
Outputs		16-Pin SO (derate 8.70mW/°C above +70°C).....	696mW
Current: REF.....	20mA	Operating Temperature Ranges	
OUT_.....	50mA	MAX97_C_/MAX98_C_.....	0°C to +70°C
Voltage: REF.....	(V+ + 0.3V) to (V- - 0.3V)	MAX97_E_/MAX98_E_.....	-40°C to +85°C
OUT_ (MAX9_1/9_4).....	12V to (GND - 0.3V)	Storage Temperature Range.....	
(MAX9_2/9_3).....	12V to (V- - 0.3V)	-65°C to +150°C	
OUT_ Short-Circuit Duration.....	Continuous	Lead Temperature (soldering, 10s).....	
Continuous Power Dissipation (TA = +70°C)		+300°C	
8-Bump UCSP (derate 4.7mW/°C above +70°C).....	379mW	Bump Temperature (soldering)	
		Reflow.....	
		+235°C	

Stresses beyond those listed under "Absolute Maximum Ratings" may cause permanent damage to the device. These are stress ratings only, and functional operation of the device at these or any other conditions beyond those indicated in the operational sections of the specifications is not implied. Exposure to absolute maximum rating conditions for extended periods may affect device reliability.

ELECTRICAL CHARACTERISTICS—5V OPERATION

(V+ = 5V, V- = GND = 0V, TA = TMIN to TMAX, unless otherwise noted. Typical values are at TA = +25°C.) (Note 1)

PARAMETER	CONDITIONS		MIN	TYP	MAX	UNITS
POWER REQUIREMENTS						
Supply Voltage Range	(Note 2)		2.5		11	V
Output Voltage Range			0		11	V
Supply Current	IN+ = IN- + 100mV	MAX9_1, HYST = REF	TA = +25°C	2.5	3.2	μA
			C/E temp ranges		4	
		MAX972	TA = +25°C	2.5	3.2	
			C/E temp ranges		4	
		MAX982/MAX9_3, HYST = REF	TA = +25°C	3.1	4.5	
			C/E temp ranges		6	
	MAX9_4	TA = +25°C	5.5	6.5		
		C/E temp ranges		8.5		
COMPARATOR						
Input Offset Voltage	VCM = 2.5V				±10	mV
Input Leakage Current (IN-, IN+)	IN+ = IN- = 2.5V	C/E temp ranges		±0.01	±5	nA
Input Leakage Current (HYST)	MAX9_1/MAX982/MAX9_3			±0.02		nA
Input Common-Mode Voltage Range			V-		V+ - 1.3	V
Common-Mode Rejection Ratio	V- to (V+ - 1.3V)			0.1	1.0	mV/V
Power-Supply Rejection Ratio	V+ = 2.5V to 11V			0.1	1.0	mV/V
Voltage Noise	100Hz to 100kHz			20		μVRMS
Hysteresis Input Voltage Range	MAX9_1/MAX982/MAX9_3		REF - 0.05		REF	V
Response Time (High-to-Low Transition)	TA = +25°C, 100pF load, 1MΩ pullup to V+	Overdrive = 10mV		12		μs
		Overdrive = 100mV		4		
Response Time (Low-to-High Transition) (Note 3)	TA = +25°C, 100pF load, 1MΩ pullup to V+			300		μs

Ultra-Low-Power, Open-Drain, Single/Dual-Supply Comparators

MAX971-MAX974/MAX981-MAX984

ELECTRICAL CHARACTERISTICS—5V OPERATION (continued)

(V+ = 5V, V- = GND = 0V, T_A = T_{MIN} to T_{MAX}, unless otherwise noted. Typical values are at T_A = +25°C.) (Note 1)

PARAMETER	CONDITIONS		MIN	TYP	MAX	UNITS	
Output Low Voltage	MAX9_2/MAX9_3, I _{OUT} = 1.8mA				V- + 0.4	V	
	MAX9_1/MAX9_4, I _{OUT} = 1.8mA				GND + 0.4		
Output Leakage Current	V _{OUT} = 11V				100	nA	
REFERENCE (MAX9_1/MAX982/MAX9_3/MAX9_4 ONLY)							
Reference Voltage	MAX971/MAX973/ MAX974	C temp range	1%	1.170	1.182	1.194	V
		E temp range	2%	1.158		1.206	
	MAX981-MAX984	C temp range	2%	1.158	1.182	1.206	
		E temp range	3%	1.147		1.217	
Source Current	T _A = +25°C		15	25		μA	
	C/E temp ranges		6				
Sink Current	T _A = +25°C		8	15		μA	
	C/E temp ranges		4				
Voltage Noise	100Hz to 100kHz			100		μVRMS	

ELECTRICAL CHARACTERISTICS—3V OPERATION

(V+ = 3V, V- = GND = 0V, T_A = T_{MIN} to T_{MAX}, unless otherwise noted. Typical values are at T_A = +25°C.) (Note 1)

PARAMETER	CONDITIONS		MIN	TYP	MAX	UNITS	
POWER REQUIREMENTS							
Supply Current	HYST = REF, IN+ = (IN- + 100mV)	MAX9_1	T _A = +25°C		2.4	3.0	μA
			C/E temp ranges			3.8	
		MAX972	T _A = +25°C		2.4	3.0	
			C/E temp ranges			3.8	
		MAX982/ MAX9_3	T _A = +25°C		3.4	4.3	
			C/E temp ranges			5.8	
		MAX9_4	T _A = +25°C		5.2	6.2	
			C/E temp ranges			8.0	
COMPARATOR							
Input Offset Voltage	V _{CM} = 1.5V				±10	mV	
Input Leakage Current (IN-, IN+)	IN+ = IN- = 1.5V	C/E temp ranges		±0.01	±5	nA	
Input Leakage Current (HYST)	MAX9_1/MAX982/MAX9_3			±0.02		nA	
Input Common-Mode Voltage Range			V-		V+ - 1.3	V	
Common-Mode Rejection Ratio	V- to (V+ - 1.3V)			0.2	1	mV/V	
Power-Supply Rejection Ratio	V+ = 2.5V to 11V			0.1	1	mV/V	
Voltage Noise	100Hz to 100kHz			20		μVRMS	
Hysteresis Input Voltage Range	MAX9_1/MAX982/MAX9_3		REF - 0.05		REF	V	

Ultra-Low-Power, Open-Drain, Single/Dual-Supply Comparators

ELECTRICAL CHARACTERISTICS—3V OPERATION (continued)

(V+ = 3V, V- = GND = 0V, T_A = T_{MIN} to T_{MAX}, unless otherwise noted. Typical values are at T_A = +25°C.) (Note 1)

PARAMETER	CONDITIONS		MIN	TYP	MAX	UNITS	
Response Time (High-to-Low Transition)	T _A = +25°C, 100pF load, 1MΩ pullup to V+	Overdrive = 10mV		12		μs	
		Overdrive = 100mV		4			
Response Time (Low-to-High Transition) (Note 3)	T _A = +25°C, 100pF load, 1MΩ pullup to V+			300		μs	
Output Low Voltage	MAX9_2/MAX9_3, I _{OUT} = 0.8mA				V- + 0.4	V	
	MAX9_1/MAX9_4, I _{OUT} = 0.8mA				GND + 0.4		
Output Leakage Current	V _{OUT} = 11V				100	nA	
REFERENCE							
Reference Voltage	MAX971/MAX973/ MAX974	C temp range	1%	1.170	1.182	1.194	V
		E temp range	2%	1.158		1.206	
	MAX981-MAX984	C temp range	2%	1.158	1.182	1.206	
		E temp range	3%	1.147		1.217	
Source Current	T _A = +25°C		15	25		μA	
	C/E temp ranges		6				
Sink Current	T _A = +25°C		8	15		μA	
	C/E temp ranges		4				
Voltage Noise	100Hz to 100kHz			100		μV _{RMS}	

Note 1: The MAX972EBL is 100% tested at T_A = +25°C. Temperature limits are guaranteed by design.

Note 2: MAX974/MAX984 comparators work below 2.5V; see *Low-Voltage* Operation section for more details.

Note 3: Low-to-high response time is the result of the 1MΩ pullup and the 100pF capacitive load, based on three time constants. A faster response time is achieved with a smaller RC.

Ultra-Low-Power, Open-Drain, Single/Dual-Supply Comparators

Typical Operating Characteristics

($V_+ = 5V$, $V_- = GND = 0V$, $T_A = +25^\circ C$, unless otherwise noted.)

MAX971-MAX974/MAX981-MAX984

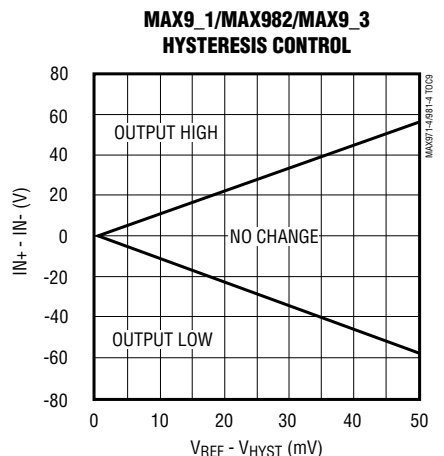
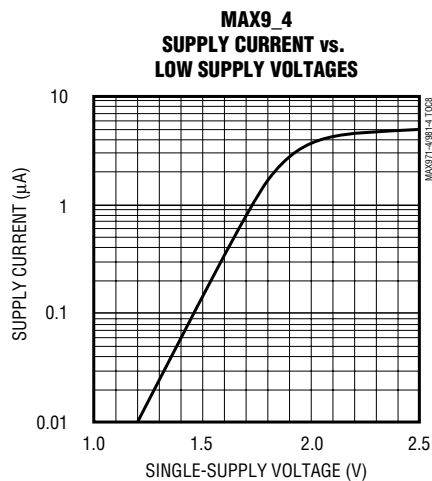
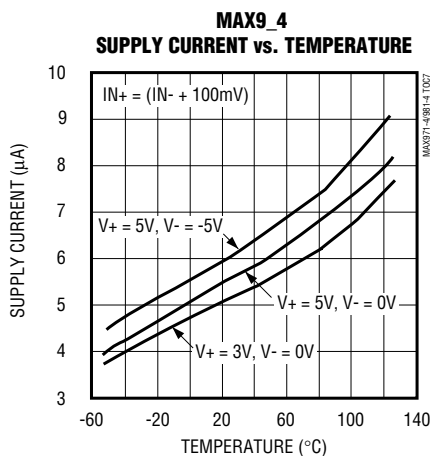
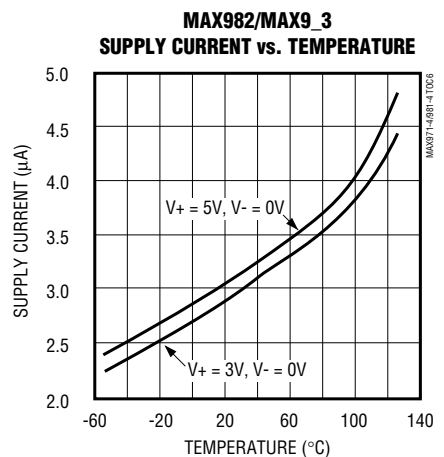
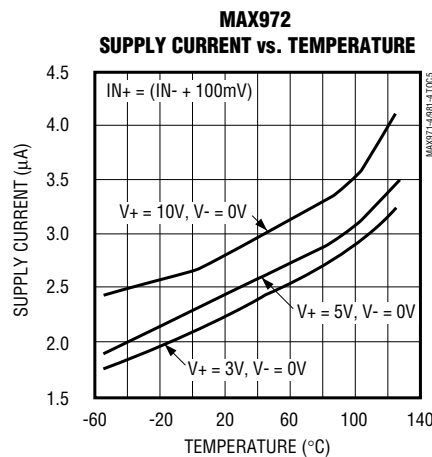
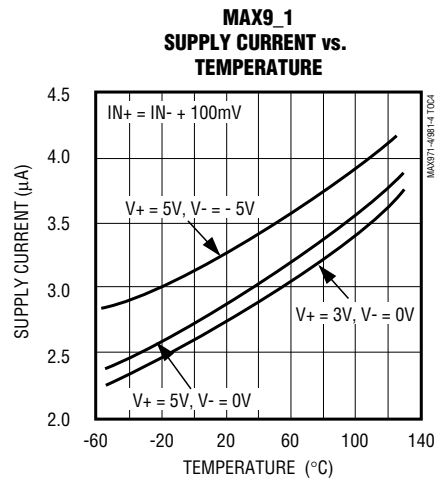
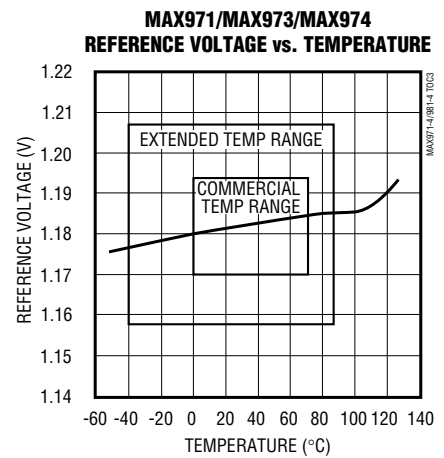
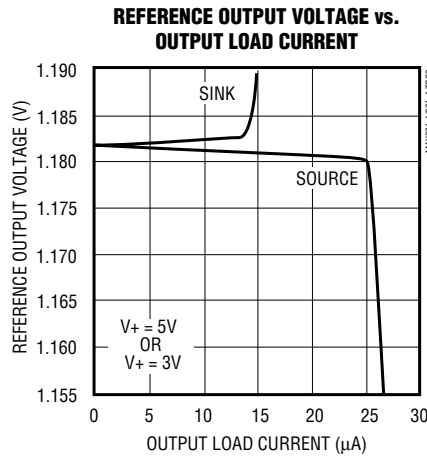
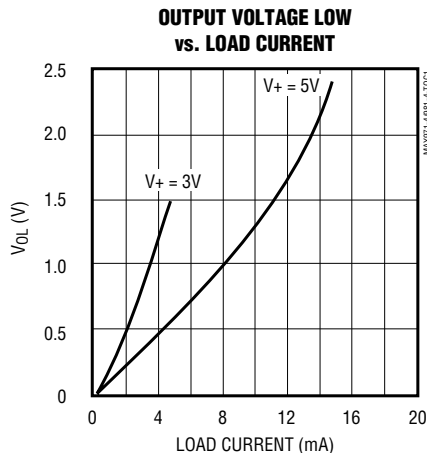

Ultra-Low-Power, Open-Drain, Single/Dual-Supply Comparators

Typical Operating Characteristics (continued)

($V_+ = 5V$, $V_- = GND = 0V$, $T_A = +25^\circ C$, unless otherwise noted.)



Ultra-Low-Power, Open-Drain, Single/Dual-Supply Comparators

Pin Description

PIN					NAME	FUNCTION
MAX971/ MAX981	MAX972		MAX982	MAX973/ MAX983		
DIP/SO/ μMAX	DIP/SO/ μMAX	UCSP	DIP/SO/ μMAX	DIP/SO/ μMAX		
1	—	—	—	—	GND	Ground. Connect to V- for single-supply operation.
2	2	C2	2	2	V-	Negative Supply. Connect to GND for single-supply operation (MAX9_1).
3	—	—	—	—	IN+	Noninverting Comparator Input
4	—	—	—	—	IN-	Inverting Comparator Input
5	—	—	5	5	HYST	Hysteresis Input. Connect to REF if not used. Input voltage range is from V _{REF} to (V _{REF} - 50mV).
6	—	—	6	6	REF	Reference Output. 1.182V with respect to V-.
7	7	A2	7	7	V+	Positive Supply
8	—	—	—	—	OUT	Comparator Output. Sinks current to GND.
—	1	A1	1	1	OUTA	Comparator A Open-Drain Output. Sinks current to V-.
—	3	C1	3	3	INA+	Noninverting Input of Comparator A
—	4	B1	—	—	INA-	Inverting Input of Comparator A
—	5	B3	—	4	INB-	Inverting Input of Comparator B
—	6	C3	4	—	INB+	Noninverting Input of Comparator B
—	8	A3	8	8	OUTB	Comparator B Open-Drain Output. Sinks current to V-.

MAX971-MAX974/MAX981-MAX984

Ultra-Low-Power, Open-Drain, Single/Dual-Supply Comparators

Pin Description (continued)

PIN	NAME	FUNCTION
MAX974 MAX984		
1	OUTB	Comparator B Open-Drain Output. Sinks current to GND.
2	OUTA	Comparator A Open-Drain Output. Sinks current to GND.
3	V+	Positive Supply
4	INA-	Inverting Input of Comparator A
5	INA+	Noninverting Input of Comparator A
6	INB-	Inverting Input of Comparator B
7	INB+	Noninverting Input of Comparator B
8	REF	Reference Output. 1.182V with respect to V-.
9	V-	Negative Supply. Connect to ground for single-supply operation.
10	INC-	Inverting Input of Comparator C
11	INC+	Noninverting Input of Comparator C
12	IND-	Inverting Input of Comparator D
13	IND+	Noninverting Input of Comparator D
14	GND	Ground. Connect to V- for single-supply operation.
15	OUTD	Comparator D Open-Drain Output. Sinks current to GND.
16	OUTC	Comparator C Open-Drain Output. Sinks current to GND.

Ultra-Low-Power, Open-Drain, Single/Dual-Supply Comparators

MAX971-MAX974/MAX981-MAX984

Detailed Description

The MAX971-MAX974/MAX981-MAX984 comprise various combinations of a micropower 1.182V reference and micropower comparators. The *Typical Operating Circuit* shows the MAX971/MAX981 configuration, and Figures 1a-1d show the MAX9_2-MAX9_4 configurations.

Internal hysteresis in the MAX9_1, MAX982, and MAX9_3 provides the easiest method for implementing hysteresis. It also produces faster hysteresis action and consumes much less current than circuits using external positive feedback.

Power-Supply and Input Signal Ranges

This family of devices operates from a single 2.5V to 11V power supply. The MAX9_1 and MAX9_4 have a separate ground for the output driver, allowing operation with dual supplies ranging from $\pm 1.25V$ to $\pm 5.5V$. Connect V- to GND when operating the MAX9_1 or MAX9_4 from a single supply. The maximum total supply voltage in this case is still 11V.

For proper comparator operation, the input signal can range from the negative supply (V-) to within one volt of the positive supply ($V+ - 1V$). The guaranteed common-mode input voltage range extends from V- to ($V+ - 1.3V$). The inputs can be taken above and below the supply rails by up to 300mV without damage.



Figure 1a. MAX972 Functional Diagram



Figure 1c. MAX973/MAX983 Functional Diagram (Window Comparator)



Figure 1b. MAX982 Functional Diagram



Figure 1d. MAX974/MAX984 Functional Diagram

Ultra-Low-Power, Open-Drain, Single/Dual-Supply Comparators

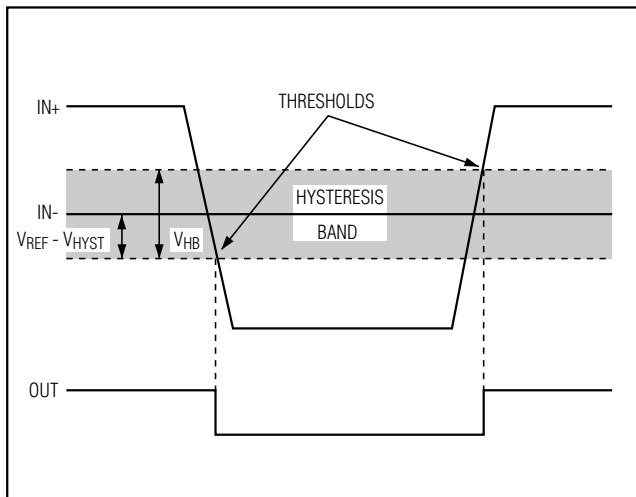

Figure 2. Threshold Hysteresis Band

Low-Voltage Operation: $V_+ = 1V$ (MAX9_4 Only)

The guaranteed minimum operating voltage is 2.5V (or $\pm 1.25V$). As the total supply voltage falls below 2.5V, performance degrades and the supply current falls. The reference will not function below about 2.2V, although the comparators will continue to operate with a total supply voltage as low as 1V. While the MAX9_4 has comparators that may be used at supply voltages below 2V, the MAX9_1/MAX9_2/MAX9_3 may not be used with supply voltages below 2.5V.

At low supply voltages, the comparators' output sink capability is reduced and the propagation delay increases (see *Typical Operating Characteristics*). The useful input voltage range extends from the negative supply to a little under 1V below the positive supply, which is slightly closer to the positive rail than when the device operates from higher supply voltages. Test your prototype over the full temperature and supply-voltage range if you anticipate operation below 2.5V.

Comparator Output

With 100mV of overdrive, propagation delay is typically 3 μ s. The *Typical Operating Characteristics* show the propagation delay for various overdrive levels. The open-drain outputs are intended for wire-ORed and level-shifting applications. The maximum output voltage is 11V above V_- , and may be applied even when no supply voltage is present ($V_+ = V_-$).

The MAX9_1 and MAX9_4 outputs sink current to GND, making these devices ideal for bipolar to single-ended conversion and level-shifting applications.

The negative supply does not affect the output sink current. The positive supply provides gate drive for the output N-channel MOSFET and heavily influences the output current capability, especially at low supply voltages (see *Typical Operating Characteristics* section).

The MAX9_2 and MAX9_3 have no GND pin, and their outputs sink current to V_- .

Voltage Reference

The internal bandgap voltage reference has an output of 1.182V above V_- . Note that the REF voltage is referenced to V_- , not to GND. Its accuracy is $\pm 1\%$ (MAX971/MAX973/MAX974) or $\pm 2\%$ (MAX981-MAX984) in the 0°C to +70°C range. The REF output is typically capable of sourcing 25 μ A and sinking 15 μ A. Do not bypass the REF output.

Noise Considerations

Although the comparators have a very high gain, useful gain is limited by noise. This is shown in the Transfer Function graph (see *Typical Operating Characteristics*). As the input voltage approaches the comparator's offset, the output begins to bounce back and forth; this peaks when $V_{IN} = V_{OS}$. (The lowpass filter shown on the graph averages out the bouncing, making the transfer function easy to observe.) Consequently, the comparator has an effective wideband peak-to-peak noise of around 300 μ V. The voltage reference has peak-to-peak noise approaching 1mV. Thus, when a comparator is used with the reference, the combined peak-to-peak noise is about 1mV. This, of course, is much higher than the RMS noise of the individual components. Take care in your layout to avoid capacitive coupling from any output to the reference pin. Crosstalk can significantly increase the actual noise of the reference.



Figure 3. Programming the HYST Pin

Ultra-Low-Power, Open-Drain, Single/Dual-Supply Comparators

Applications Information

Hysteresis

Hysteresis increases the comparators' noise margin by increasing the upper threshold and decreasing the lower threshold (Figure 2).

Hysteresis (MAX9_1/MAX982/MAX9_3)

To add hysteresis to the MAX9_1, MAX982, or MAX9_3, connect resistor R1 between REF and HYST, and connect resistor R2 between HYST and V- (Figure 3). If no hysteresis is required, connect HYST to REF. When hysteresis is added, the upper threshold increases by the same amount that the lower threshold decreases. The hysteresis band (the difference between the upper and lower thresholds, V_{HB}) is approximately equal to twice the voltage between REF and HYST. The HYST input can be adjusted to a maximum voltage of REF and to a minimum voltage of (REF - 50mV). The maximum difference between REF and HYST (50mV) will therefore produce a 100mV (max) hysteresis band. Use the following equations to determine R1 and R2:

$$R1 = \frac{V_{HB}}{(2 \times I_{REF})}$$

$$R2 = \frac{\left(1.182 - \frac{V_{HB}}{2}\right)}{I_{REF}}$$

where I_{REF} (the current sourced by the reference) should not exceed the REF source capability, and should be significantly larger than the HYST input current. I_{REF} values between 0.1 μ A and 4 μ A are usually appropriate. If 2.4M Ω is chosen for R2 ($I_{REF} = 0.5\mu$ A), the equation for R1 and V_{HB} can be approximated as:

$$R1 \text{ (k}\Omega\text{)} = V_{HB} \text{ (mV)}$$

When hysteresis is obtained in this manner for the MAX982/MAX9_3, the same hysteresis applies to both comparators.

Hysteresis (MAX972/MAX9_4)

Hysteresis can be implemented with any comparator using positive feedback, as shown in Figure 4. This approach generally draws more current than circuits using the HYST pin on the MAX9_1/MAX982/MAX9_3, and the high feedback impedance slows hysteresis. In addition, because the output does not source current, any increase in the upper threshold is dependent on the load or pullup resistor on the output.

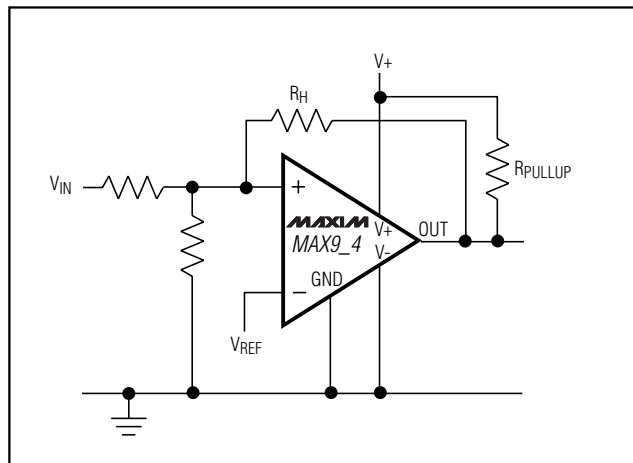

Figure 4. External Hysteresis

Board Layout and Bypassing

Power-supply bypass capacitors are not needed if the supply impedance is low, but 100nF bypass capacitors should be used when the supply impedance is high or when the supply leads are long. Minimize signal lead lengths to reduce stray capacitance between the input and output that might cause instability. Do not bypass the reference output.

Window Detector

The MAX9_3 is ideal for making window detectors (undervoltage/overvoltage detectors). The schematic is shown in Figure 5, with component values selected for a 4.5V undervoltage threshold and a 5.5V overvoltage threshold. Choose different thresholds by changing the values of R1, R2, and R3. To prevent chatter at the output when the supply voltage is close to a threshold, hysteresis has been added using R4 and R5. Taken alone, OUTA would provide an active-low undervoltage indication, and OUTB would give an active-low overvoltage indication. Wired-ORing the two outputs provides an active-high, power-good signal.

The design procedure is as follows:

- 1) Choose the required hysteresis level and calculate values for R4 and R5 according to the formulas in the *Hysteresis (MAX9_1/MAX982/MAX9_3)* section. In this example, ± 5 mV of hysteresis has been added at the comparator input ($V_H = V_{HB}/2$). This means that the hysteresis apparent at V_{IN} will be larger because of the input resistor divider.

Ultra-Low-Power, Open-Drain, Single/Dual-Supply Comparators

2) Select R1. The leakage current into INB- is normally under 1nA, so the current through R1 should exceed 100nA for the thresholds to be accurate. R1 values up to about 10MΩ can be used, but values in the 100kΩ to 1MΩ range are usually easier to deal with. In this example, choose R1 = 294kΩ.

3) Calculate R2 + R3. The overvoltage threshold should be 5.5V when VIN is rising. The design equation is as follows:

$$\begin{aligned}
 R2 + R3 &= R1 \times \left(\frac{V_{OTH}}{V_{REF} + V_H} - 1 \right) \\
 &= 294k\Omega \times \left(\frac{5.5}{(1.182 + 0.005)} - 1 \right) \\
 &= 1.068M\Omega
 \end{aligned}$$

4) Calculate R2. The undervoltage threshold should be 4.5V when VIN is falling. The design equation is as follows:

$$\begin{aligned}
 R2 &= (R1 + R2 + R3) \times \frac{(V_{REF} - V_H)}{V_{UTH}} - R1 \\
 &= (294k\Omega + 1.068M\Omega) \times \frac{(1.182 - 0.005)}{4.5} \\
 &\quad - 294k\Omega \\
 &= 62.2k\Omega
 \end{aligned}$$

Choose R2 = 61.9kΩ (1% standard value).

5) Calculate R3:

$$\begin{aligned}
 R3 &= (R2 + R3) - R2 \\
 &= 1.068M\Omega - 61.9k\Omega \\
 &= 1.006M\Omega
 \end{aligned}$$

Choose R3 = 1MΩ (1% standard value)

6) Verify the resistor values. The equations are as follows, evaluated for the above example:

Overvoltage Threshold:

$$\begin{aligned}
 V_{OTH} &= (V_{REF} + V_H) \times \frac{(R1 + R2 + R3)}{R1} \\
 &= 5.474V
 \end{aligned}$$

Undervoltage Threshold:

$$\begin{aligned}
 V_{UTH} &= (V_{REF} - V_H) \times \frac{(R1 + R2 + R3)}{(R1 + R2)} \\
 &= 4.484V
 \end{aligned}$$

where the hysteresis voltage $V_H = V_{REF} \times \frac{R5}{R4}$.

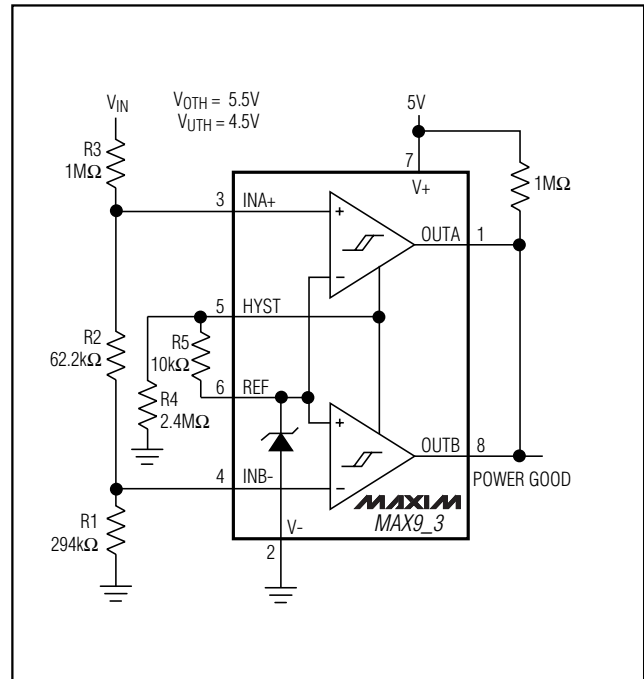

Figure 5. Window Detector

Battery Switchover Circuit

The switchover from line-powered DC to a backup battery is often accomplished with diodes. But this simple method is sometimes unacceptable, due to the voltage drop and associated power loss across the diode in series with the battery. Figure 6's circuit replaces the diode with a P-channel MOSFET controlled by one of the MAX9_3 comparator outputs.

When the DC wall adapter drops below 4V (determined by R1 and R2), OUTA goes low, turning on Q1. Comparator B is used to measure the battery voltage, and gives a "low-battery" indication when the battery drops below 3.6V.

Level-Shifter

Figure 7 shows a circuit to shift from bipolar ±5V inputs to single-ended 5V outputs. The 10kΩ resistors protect the comparator inputs, and do not materially affect the circuit's operation.

Ultra-Low-Power, Open-Drain, Single/Dual-Supply Comparators

MAX971-MAX974/MAX981-MAX984



Figure 6. Battery Switchover Circuit



Figure 7. Level Shifter: $\pm 5V$ Input to Single-Ended 3.3V Output

UCSP Applications Information

For the latest application details on UCSP construction, dimensions, tape carrier information, printed circuit board techniques, bump-pad layout and recommended reflow temperature profile as well as the latest information on reliability testing results, go to Maxim's web site at www.maxim-ic.com/ucsp to find the Application Note: *UCSP-A Wafer-Level Chip-Scale Package*.

Ultra-Low-Power, Open-Drain, Single/Dual-Supply Comparators

Pin Configurations

TOP VIEW



TOP VIEW
(BUMPS ON BOTTOM)

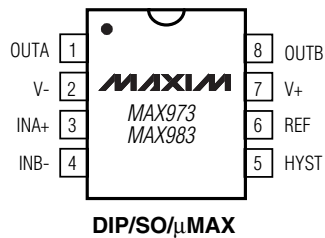

Ultra-Low-Power, Open-Drain, Single/Dual-Supply Comparators

Ordering Information (continued)

PART	TEMP RANGE	PIN-PACKAGE
MAX971EPA	-40°C to +85°C	8 Plastic Dip
MAX971ESA	-40°C to +85°C	8 SO
MAX972 CPA	0°C to +70°C	8 Plastic Dip
MAX972CSA	0°C to +70°C	8 SO
MAX972CUA	0°C to +70°C	8 μMAX
MAX972EBL-T*	-40°C to +85°C	8 UCSP-8
MAX972EPA	-40°C to +85°C	8 Plastic Dip
MAX972ESA	-40°C to +85°C	8 SO
MAX973 CPA	0°C to +70°C	8 Plastic Dip
MAX973CSA	0°C to +70°C	8 SO
MAX973CUA	0°C to +70°C	8 μMAX
MAX973EPA	-40°C to +85°C	8 Plastic Dip
MAX973ESA	-40°C to +85°C	8 SO
MAX974 CPE	0°C to +70°C	16 Plastic Dip
MAX974CSE	0°C to +70°C	16 Narrow SO
MAX974EPE	-40°C to +85°C	16 Plastic Dip
MAX974ESE	-40°C to +85°C	16 Narrow SO
MAX981 CPA	0°C to +70°C	8 Plastic Dip

*UCSP top mark is "ABC."

PART	TEMP RANGE	PIN-PACKAGE
MAX981CSA	0°C to +70°C	8 SO
MAX981CUA	0°C to +70°C	8 μMAX
MAX981EPA	-40°C to +85°C	8 Plastic Dip
MAX981ESA	-40°C to +85°C	8 SO
MAX982 CPA	0°C to +70°C	8 Plastic Dip
MAX982CSA	0°C to +70°C	8 SO
MAX982CUA	0°C to +70°C	8 μMAX
MAX982EPA	-40°C to +85°C	8 Plastic Dip
MAX982ESA	-40°C to +85°C	8 SO
MAX983 CPA	0°C to +70°C	8 Plastic Dip
MAX983CSA	0°C to +70°C	8 SO
MAX983CUA	0°C to +70°C	8 μMAX
MAX983EPA	-40°C to +85°C	8 Plastic Dip
MAX983ESA	-40°C to +85°C	8 SO
MAX984 CPE	0°C to +70°C	16 Plastic Dip
MAX984CSE	0°C to +70°C	16 Narrow SO
MAX984EPE	-40°C to +85°C	16 Plastic Dip
MAX984ESE	-40°C to +85°C	16 Narrow SO

Chip Information

MAX971/MAX972/MAX973/MAX981/MAX982/MAX984
TRANSISTOR COUNT: 164

MAX974/MAX984 TRANSISTOR COUNT: 267

MAX971-MAX974/MAX981-MAX984

Ultra-Low-Power, Open-Drain, Single/Dual-Supply Comparators

Package Information

(The package drawing(s) in this data sheet may not reflect the most current specifications. For the latest package outline information, go to www.maxim-ic.com/packages.)



8L uMAX/uSOP



.150" SOIC

Ultra Low-Power, Open-Drain, Single/Dual-Supply Comparators

Package Information (continued)

(The package drawing(s) in this data sheet may not reflect the most current specifications. For the latest package outline information, go to www.maxim-ic.com/packages.)

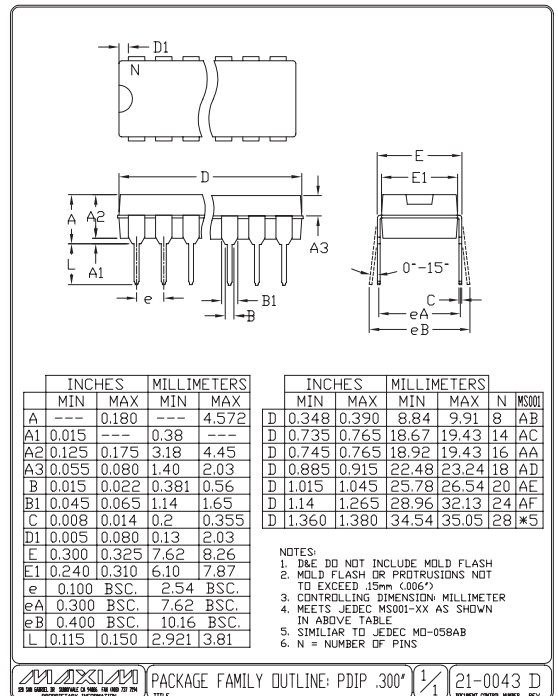

Maxim cannot assume responsibility for use of any circuitry other than circuitry entirely embodied in a Maxim product. No circuit patent licenses are implied. Maxim reserves the right to change the circuitry and specifications without notice at any time.

Maxim Integrated Products, 120 San Gabriel Drive, Sunnyvale, CA 94086 408-737-7600 17

Looking for pricing, stock, or lifecycle information?

Click below to explore more details on WIN SOURCE:

 [View MAX973CSA+T on WIN SOURCE](#)

 [Maxim Integrated](#) Information

Optimize Your Supply Chain with WIN SOURCE Solutions

-  Global Sourcing Solution
-  Obsolete Management
-  Cost Control Management
-  Shortage Management
-  Alternative Solution
-  Excess Inventory Management