

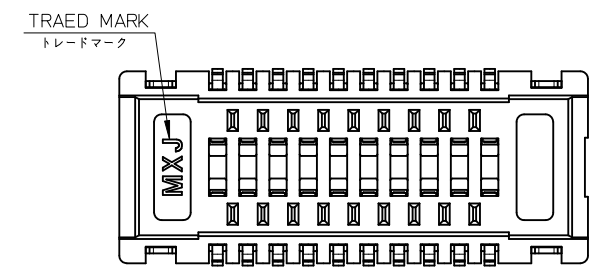

THE DATASHEET OF
5034896010

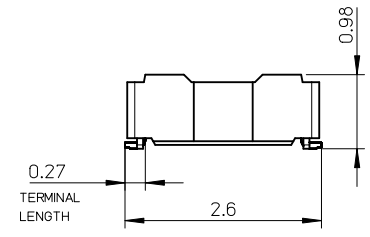

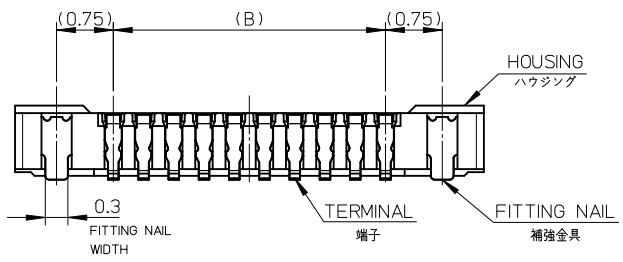
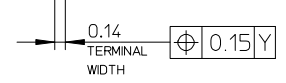
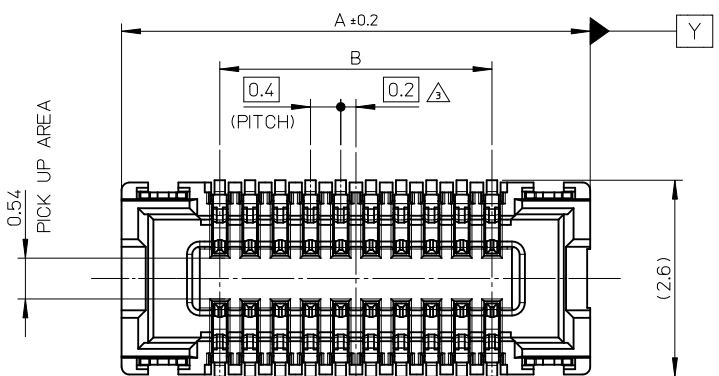

注記 NOTES

1. 使用材料 MATERIAL
 ハウジング: 液晶ポリマー (LCP) ガラス充填 UL94V-0 (黒)
 HOUSING: LIQUID CRYSTAL POLYMER (GLASS FILLED) UL94V-0 (COLOR: BLACK)
 ターミナル: 銅合金
 TERMINAL: COPPER ALLOY
 金具: 銅合金
 FITTING NAIL: COPPER ARROY
2. メッキ仕様 PLATING
 ターミナル TERMINAL
 コンタクト部 金メッキ 0.1マイクロメートル以上
 CONTACT AREA GOLD 0.1 MICROMETER MINIMUM
 下地メッキ: ニッケルメッキ 1.0マイクロメートル以上
 UNDER PLATING: NICKEL 1.0 MICROMETER MINIMUM
 ※コンタクト部とテール部はニッケルメッキによって分断されている金メッキです。
 DIVIDE INTO PARTS THE GOLD PLATING OF THE CONTACT AND THE TAIL PART BY THE NICKEL PLATING.
 ※封孔処理品
 SEALING TREATMENT
 金具 FITTING NAIL
 錫メッキ 1.0マイクロメートル以上
 Tin PLATING 1.0 MICROMETER MINIMUM
 下地メッキ: ニッケルメッキ 1.0マイクロメートル以上
 UNDER PLATING: NICKEL 1.0 MICROMETER MINIMUM
- △ (全極数 / 2) = 偶数の場合に適用。
 APPLY FOR (CIRCUIT/2) = EVEN.
4. 嵌合相手: 503308 シリーズ
 MATE WITH: 503308 SERIES.
5. テール及び金具の平坦度は、0.1 以下
 TAIL AND FITTING NAIL COPLANARITY TO BE 0.1 MAXIMUM.
6. ELV 及び RoHS 適合品
 ELV AND RoHS COMPLIANT.

11.6	14.2	503489-6010	60
9.6	12.2	503489-5010	50
8.4	11.0	503489-4410	44
5.6	8.2	503489-3010	30
B	A	ORDER No.	CKT.
		EMBOSSED TAPE	
CONNECTOR SERIES No. : 503489-**09			

REVISED EC NO: J2011-0617 DRWN: TSUZUKI 2010/08/26 CHKD: TAKEUCHI 2010/08/26 APPR: MSASAO 2010/11/05	GENERAL TOLERANCES (UNLESS SPECIFIED)		DIMENSION STYLE MM ONLY		SCALE 15:1	DESIGN UNITS METRIC	THIRD ANGLE PROJECTION
	10 UNDER	± ---	DRAWN BY TTANIGUCHI01	DATE 2009/5/12	TITLE 0.4 B-TO-B CONN. HGT=1.0 W=2.6 REC ASSY		
	10 OVER 30 UNDER	± ---	CHECKED BY THIRATA	DATE 2009/5/12	MOLEX INCORPORATED		
	30 OVER	± ---	APPROVED BY MSASAO	DATE 2009/5/12	DOCUMENT NO. SD-503489-001	SHEET NO. 1 OF 2	
	ANGULAR ± --- ° DRAFT WHERE APPLICABLE MUST REMAIN WITHIN DIMENSIONS		MATERIAL NO. SEE CHART		THIS DRAWING CONTAINS INFORMATION THAT IS PROPRIETARY TO MOLEX INCORPORATED AND SHOULD NOT BE USED WITHOUT WRITTEN PERMISSION		

10 9 8 7 6 5 4 3 2 1

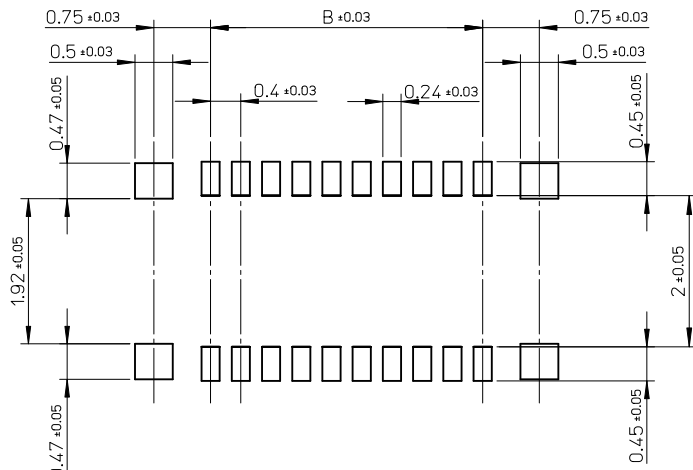

P.W. BOARD PATTERN LAYOUT
(REFERENCE)

基板レイアウト (参考)

REVISED EC NO: J2011-0617 DRWN: TSUZUKI 2010/08/26 CHKD: RTAKEUCHI 2010/08/26 APPR: MSASAO 2010/11/05	GENERAL TOLERANCES (UNLESS SPECIFIED)		DIMENSION STYLE MM ONLY	SCALE 15:1	DESIGN UNITS METRIC	THIRD ANGLE PROJECTION
	10 UNDER	± ---	DRAWN BY TTANIGUCHI01	DATE 2009/5/12	TITLE 0.4 B-TO-B CONN. HGT=1.0 W=2.6 REC ASSY	
	10 OVER 30 UNDER	± ---	CHECKED BY THIRATA	DATE 2009/5/12	MOLEX INCORPORATED	
	30 OVER	± ---	APPROVED BY MSASAO	DATE 2009/5/12		
	ANGULAR	± --- °	MATERIAL NO. SEE SHEET 1	DOCUMENT NO. SD-503489-001		SHEET NO. 2 OF 2
DRAFT WHERE APPLICABLE MUST REMAIN WITHIN DIMENSIONS		SIZE A3	THIS DRAWING CONTAINS INFORMATION THAT IS PROPRIETARY TO MOLEX INCORPORATED AND SHOULD NOT BE USED WITHOUT WRITTEN PERMISSION			

注記 NOTES

- 製品詳細寸法については製品単体図面を参照下さい。
RE DETAILED DIMENSION, SEE PRODUCT DRAWING.
- 梱包数量: 3000 個/リール
NUMBER OF CONNECTORS : 3000PCS/REEL
- リードテープ長さ LEAD TAPE LENGTH

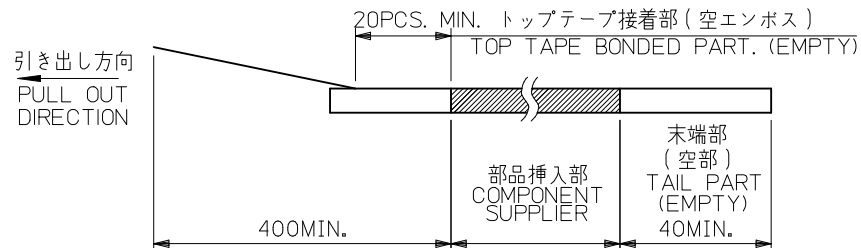
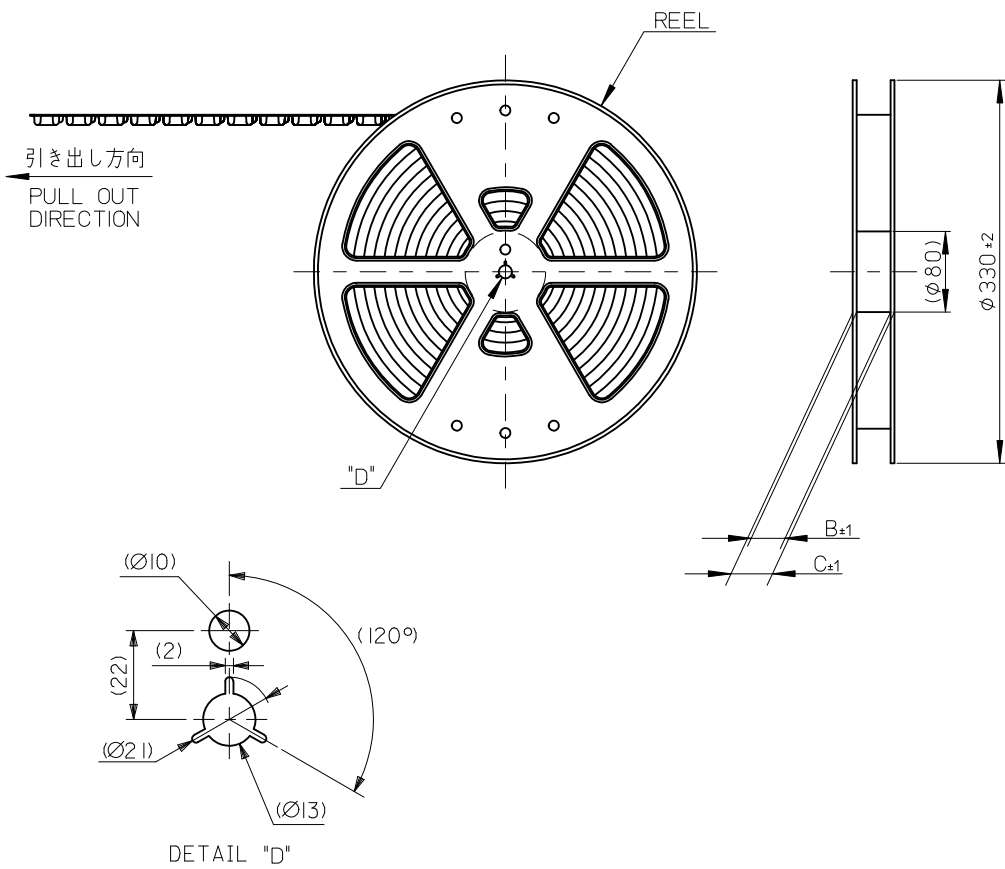

- トップテープの剥離強度: 0.1N~1.3N(10gf~130gf)
(剥離方向は下図参照)
尚、本規格値は出荷時に適用。(但し、輸送時に剥離が発生しないこと。)
PEELING OFF FORCE OF TOP TAPE : 0.1N~1.3N(10gf~130gf)
(PEELING DIRECTION AS SHOWN IN FOLLOWING FIG.)
THIS REQUIREMENT SHOULD BE APPLIED AT SHIPMENT.
PEEL OFF SHOULD NOT BE ALLOWED, DURING TRANSPORTION.

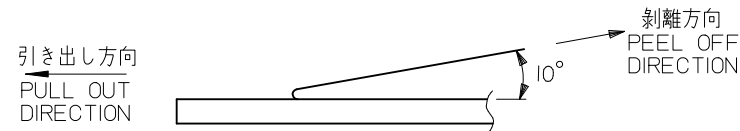

- 材料 MATERIAL
キャリアテープ (CARRIER TAPE): ポリスチレン (POLYSTYRENE)
トップテープ (TOP TAPE): PET, OTHER
リール (REEL): ポリスチレン (PS) <リサイクル材を含む>
POLYSTYRENE (PS) <RECYCLE MATERIAL CONTAINED>
- ELV 及び RoHS適合品
ELV AND RoHS COMPLIANT

MODEL NO. 503489-**10

REVISED EC NO: J2011-0617 DRWN: TSUZUKI 2010/10/28 CHKD: RTAKEUCHI 2010/11/01 APPR: MSASAO 2010/11/05	GENERAL TOLERANCES (UNLESS SPECIFIED)		DIMENSION STYLE MM ONLY		SCALE 1:1	DESIGN UNITS METRIC	THIRD ANGLE PROJECTION
	10 UNDER	±0.2	DRAWN BY TTANIGUCHI01	DATE 2009/6/11	TITLE 0.4 B-T0-B CONN. HGT=1.0 REC ASSY EMBSTP PKG		
	10 OVER 30 UNDER	±0.25	CHECKED BY THIRATA	DATE 2009/6/11	MOLEX INCORPORATED		
	30 OVER	±0.3	APPROVED BY MSASAO	DATE 2009/6/11	DOCUMENT NO. SD-503489-002		
DESCRIPTION	ANGULAR ±1 °	DRAFT WHERE APPLICABLE MUST REMAIN WITHIN DIMENSIONS		MATERIAL NO. SEE CHART		SHEET NO. 1 OF 3	

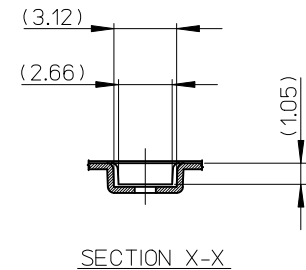
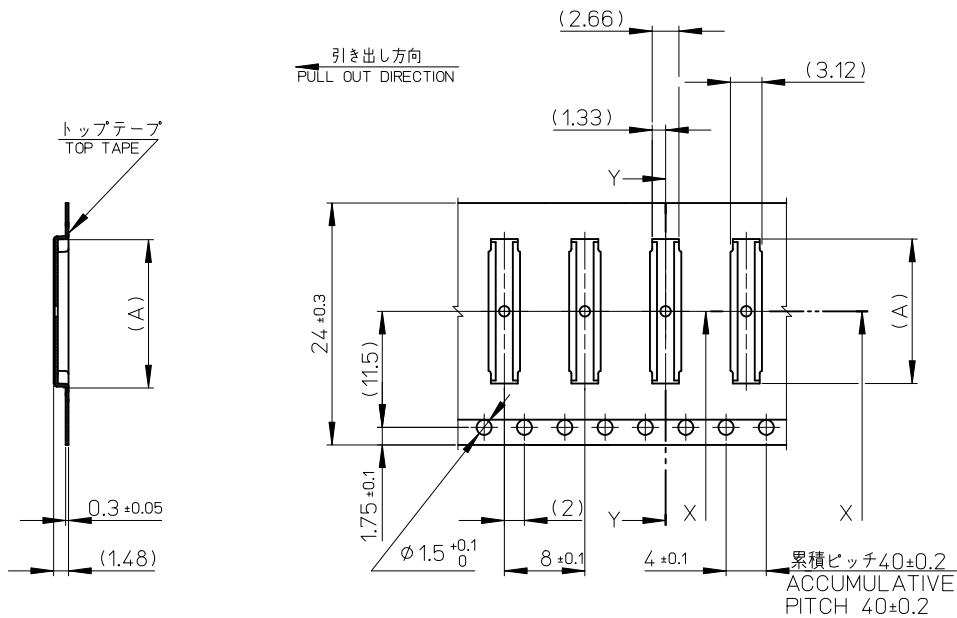

SECTION Y-Y

24mm 幅キャリアテープ
24mm WIDTH CARRIER TAPE

24	29.4	25.4	11.12	503489-4410	44
			8.32	503489-3010	30
キャリアテープ幅 CARRIER TAPE WIDTH			C	B	(A)
			MATERIAL No.		CKT.
			MODEL No.		503489-**10

REVISED EC NO: J2011-0617 DRWN: TSUZUKI 2010/10/28 CHKD: RTAKEUCHI 2010/11/01 APPR: MSASAO 2010/11/05	DESCRIPTION REV	GENERAL TOLERANCES (UNLESS SPECIFIED)		DIMENSION STYLE MM ONLY		SCALE 1:1	DESIGN UNITS METRIC	THIRD ANGLE PROJECTION		
		10 UNDER	± 0.2	DRAWN BY TTANIGUCHI01	DATE 2009/6/11	TITLE 0.4 B-T0-B CONN. HGT=1.0 REC ASSY EMBSTP PKG				
		10 OVER 30 UNDER	± 0.25	CHECKED BY THIRATA	DATE 2009/6/11	APPROVED BY MSASAO				
		30 OVER	± 0.3	APPROVED BY MSASAO		DATE 2009/6/11	MOLEX INCORPORATED			
ANGULAR $\pm 1^\circ$		DRAFT WHERE APPLICABLE MUST REMAIN WITHIN DIMENSIONS		MATERIAL NO. SEE CHART		DOCUMENT NO. SD-503489-002		SHEET NO. 2 OF 3		

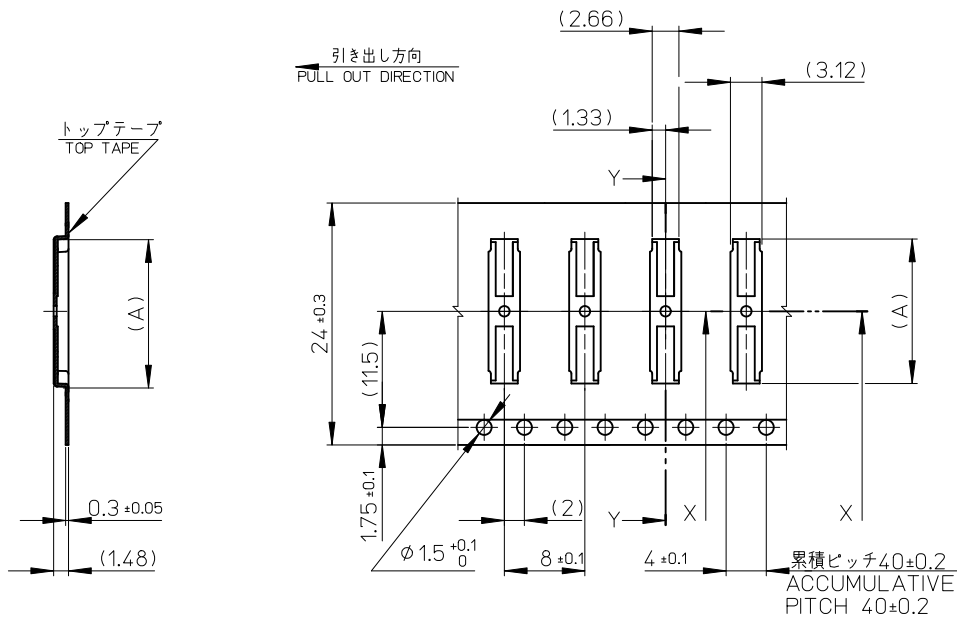

SECTION Y-Y

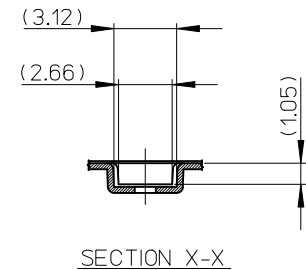

SECTION X-X

24mm 幅キャリアテープ
24mm WIDTH CARRIER TAPE

24	29.4	25.4	14.32	503489-6010	60
			12.32	503489-5010	50
キャリアテープ幅 CARRIER TAPE WIDTH			C	B	(A)
			MATERIAL No.		CKT.
			MODEL No.		503489-**10

REVISED EC NO.: J2011-0617 DRWN: TSUZUKI 2010/11/01 CHKD: TAKEUCHI 2010/11/01 APPR: MSASAO 2010/11/05	DESCRIPTION REV	GENERAL TOLERANCES (UNLESS SPECIFIED)		DIMENSION STYLE MM ONLY		SCALE 1:1	DESIGN UNITS METRIC	THIRD ANGLE PROJECTION		
		10 UNDER	±0.2	DRAWN BY TTANIGUCHI01	DATE 2009/6/1	TITLE 0.4 B-T0-B CONN. HGT=1.0 REC ASSY EMBSTP PKG				
		10 OVER 30 UNDER	±0.25	CHECKED BY THIRATA	DATE 2009/6/1	APPROVED BY MSASAO 2010/11/05				
		30 OVER	±0.3	MATERIAL NO. SEE CHART			DOCUMENT NO. SD-503489-002			
ANGULAR ±1 ° DRAFT WHERE APPLICABLE MUST REMAIN WITHIN DIMENSIONS		SIZE A3			THIS DRAWING CONTAINS INFORMATION THAT IS PROPRIETARY TO MOLEX INCORPORATED AND SHOULD NOT BE USED WITHOUT WRITTEN PERMISSION					

Looking for pricing, stock, or lifecycle information?

Click below to explore more details on WIN SOURCE:

 [View 5034896010 on WIN SOURCE](#)

 [Molex, LLC Information](#)

Optimize Your Supply Chain with WIN SOURCE Solutions

-  Global Sourcing Solution
-  Obsolete Management
-  Cost Control Management
-  Shortage Management
-  Alternative Solution
-  Excess Inventory Management