



THE DATASHEET OF CPDUR5V0HE-HF



CPDUR5V0HE-HF

RoHS Device
Halogen Free

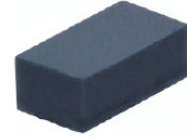

Features

- Bi-directional ESD protection
- IEC 61000-4-5 (surge) ; $I_{PP}=8A$
- IEC 61000-4-2 (ESD) ; $\pm 30KV(\text{contact})$
- Low clamping voltage
- Low leakage current
- High surge current

Mechanical data

- Case: 0603/SOD-523F Standard package, molded plastic.
- Terminals: Gold plated, solderable per MIL-STD-750, method 2026.
- Mounting position: Any.
- Weight: 0.003 grams(approx.).

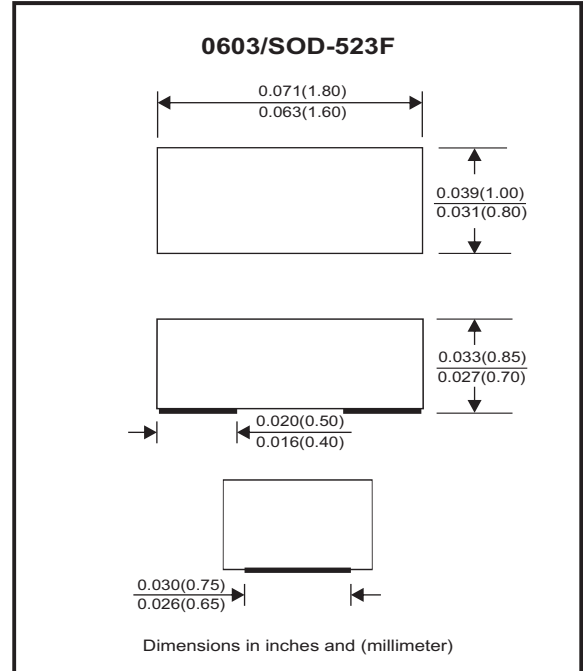

Circuit Diagram



Maximum Rating (at $T_A=25^\circ C$ unless otherwise noted)

Parameter	Conditions	Symbol	Value	Unit
Peak pulse power	$T_P = 8/20\mu s$	P_{PP}	128	W
Peak pulse current	$T_P = 8/20\mu s$	I_{PP}	8	A
ESD capability	IEC 61000-4-2(air) IEC 61000-4-2(contact)	ESD	± 30	kV
Operation temperature range		T_j	-40~+125	$^\circ C$
Storage temperature range		T_{STG}	-55~+150	$^\circ C$

Electrical Characteristics (at $T_A=25^\circ C$ unless otherwise noted)

Parameter	Conditions	Symbol	Min	Typ	Max	Unit
Working peak reverse voltage		V_{RWM}			5	V
Breakdown voltage	$I_T = 1mA$	V_{BR}	5.5	7.0		V
Reverse leakage current	$V_{RWM} = 5V$	I_R		0.1	1.0	μA
Clamping voltage	$I_{PP} = 1A, T_P = 8/20\mu s$ $I_{PP} = 8A, T_P = 8/20\mu s$	V_C			11 16	V
Junction capacitance	$V_R = 0V, f = 1MHz$	C_J		15	20	pF

RATING AND CHARACTERISTIC CURVES (CPDUR5V0HE-HF)

Fig.1- 8/20us Peak Pulse Current Wave Form Acc. IEC61000-4-5

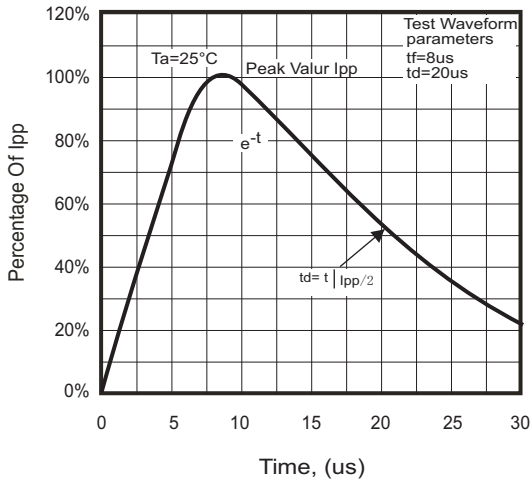

Fig.2 - Typical Capacitance Between Terminals Characteristics

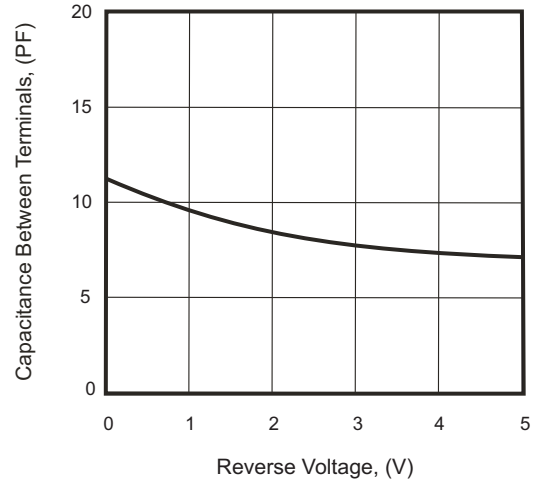

Fig.3 - Clamping Voltage Vs. Peak Pulse Current

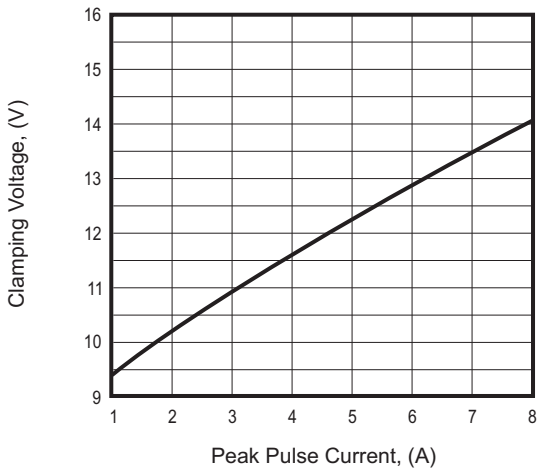
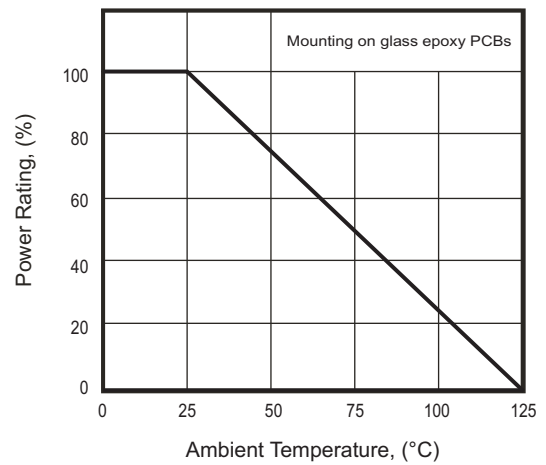
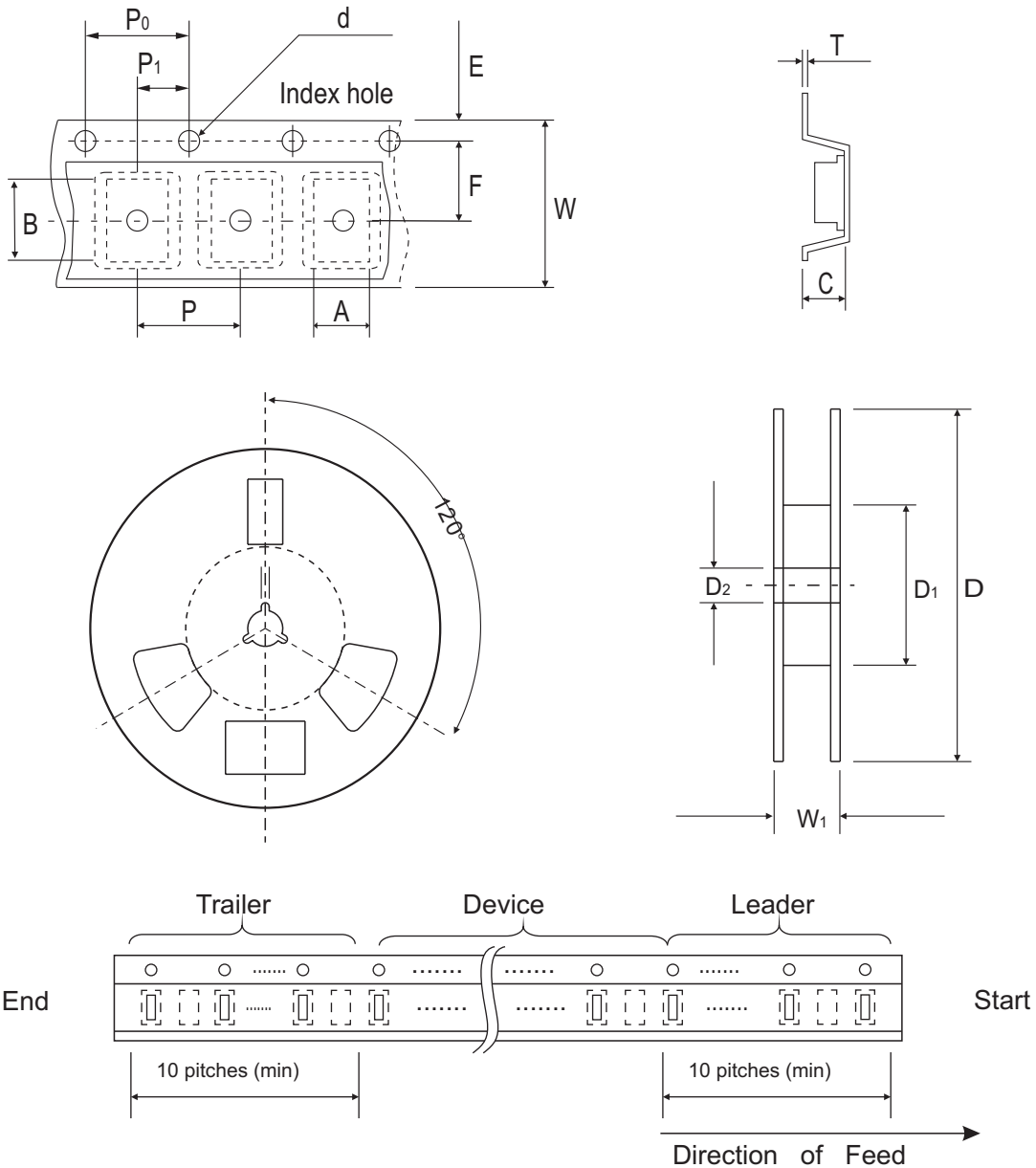

Fig. 4 - Power Rating Derating Curve



Reel Taping Specification



0603 (SOD-523)	SYMBOL	A	B	C	d	D	D ₁	D ₂
	(mm)	1.00 ± 0.10	1.85 ± 0.10	1.00 ± 0.10	1.55 ± 0.05	178 ± 1	60.0 MIN.	13.0 ± 0.20
	(inch)	0.039 ± 0.004	0.073 ± 0.004	0.039 ± 0.004	0.061 ± 0.002	7.008 ± 0.04	2.362 MIN.	0.512 ± 0.008

0603 (SOD-523)	SYMBOL	E	F	P	P ₀	P ₁	T	W	W ₁
	(mm)	1.75 ± 0.10	3.50 ± 0.05	4.00 ± 0.10	4.00 ± 0.10	2.00 ± 0.05	0.23 ± 0.05	8.00 ± 0.20	13.5 MAX.
	(inch)	0.069 ± 0.004	0.138 ± 0.002	0.157 ± 0.004	0.157 ± 0.004	0.079 ± 0.004	0.009 ± 0.002	0.315 ± 0.008	0.531 MAX.

Marking Code

Part Number	Marking Code
CPDUR5V0HE-HF	E05



Suggested PAD Layout

SIZE	0603/SOD-523F	
	(mm)	(inch)
A	1.25	0.049
B	0.60	0.024
C	1.00	0.039
D	1.85	0.073
E	0.65	0.026

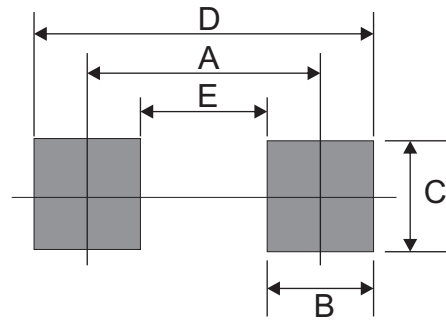

Standard Packaging

Case Type	REEL PACK	
	REEL (pcs)	Reel Size (inch)
0603/SOD-523F	4,000	7

Looking for pricing, stock, or lifecycle information?

Click below to explore more details on WIN SOURCE:

- [View CPDUR5V0HE-HF on WIN SOURCE](#)
- [Comchip Technology Information](#)

Optimize Your Supply Chain with WIN SOURCE Solutions

- ✓ Global Sourcing Solution
- ✓ Obsolete Management
- ✓ Cost Control Management
- ✓ Shortage Management
- ✓ Alternative Solution
- ✓ Excess Inventory Management