



**THE DATASHEET OF  
CPDH5V0P-HF**



# CPDH5V0P-HF

RoHS Device

Halogen Free

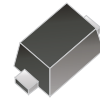

## Features

- IEC 61000-4-2 (ESD): Contact  $\pm 12$ KV.
- Bi-directional ESD protection of one line.
- Fast response time.
- Low Leakage current.
- Low reverse clamping voltage.
- Low capacitance: 3pF(Typ.)

## Mechanical data

- Case: SOD-523 standard package, molded plastic.
- Terminals: Solderable per MIL-STD-750, method 2026.
- Marking Code: HD
- Mounting position: Any
- Weight: 0.0012 grams(approx.).

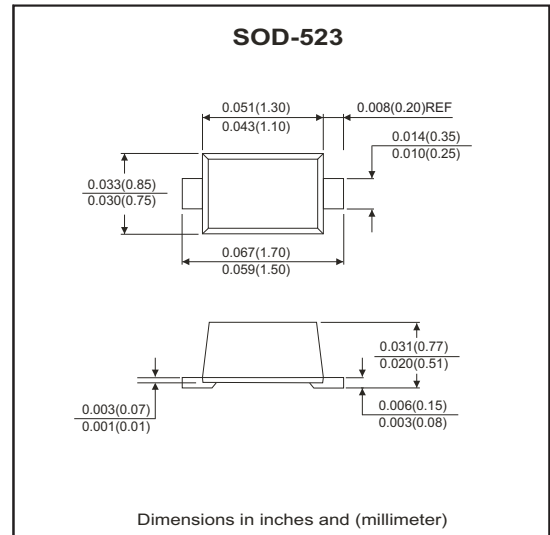

## Circuit Diagram



## Maximum Rating (at TA=25°C unless otherwise noted)

Parameter	Symbol	Value	Unit
ESD per IEC 61000-4-2 (Air)	V <sub>ESD</sub> <sup>(1)</sup>	$\pm 12$	KV
ESD per IEC 61000-4-2 (Contact)		$\pm 12$	
JESD22-A114-B ESD Voltage Per Human Body Model		$\pm 16$	
ESD Voltage Per Machine Model		$\pm 0.4$	
Peak Pulse Power	P <sub>PP</sub> <sup>(2)</sup>	39	W
Peak Pulse Current	I <sub>PP</sub> <sup>(2)</sup>	3	A
Lead Solder Temperature Maximum (10 Second Duration)	T <sub>L</sub>	260	°C
Junction temperature range	T <sub>J</sub>	-40 to +150	°C
Storage temperature range	T <sub>STG</sub>	-55 to +150	°C

## Electrical Characteristics (at TA=25°C unless otherwise noted)

Parameter	Conditions	Symbol	Min	Typ	Max	Unit
Reverse stand-off voltage		V <sub>RWM</sub> <sup>(3)</sup>			5	V
Reverse leakage current	V <sub>RWM</sub> = 5 V	I <sub>R</sub>			1	μA
Breakdown voltage	I <sub>T</sub> = 1 mA	V(BR)	5.6		8	V
Clamping voltage	I <sub>PP</sub> = 3 A	V <sub>C</sub> <sup>(2)</sup>			13	V
Junction capacitance	V <sub>R</sub> = 0V , F = 1MHz	C <sub>J</sub>		3		pF

Notes: 1. Device stressed with ten non-repetitive ESD pulses.  
 2. Non-repetitive current pulse 8/20μs exponential decay waveform according to IEC61000-4-5.  
 3. Other voltages available upon request.

## RATING AND CHARACTERISTIC CURVES (CPDH5V0P-HF)

Fig.1 - 8/20us Peak Pulse Current Waveform ACC. IEC 61000-4-5

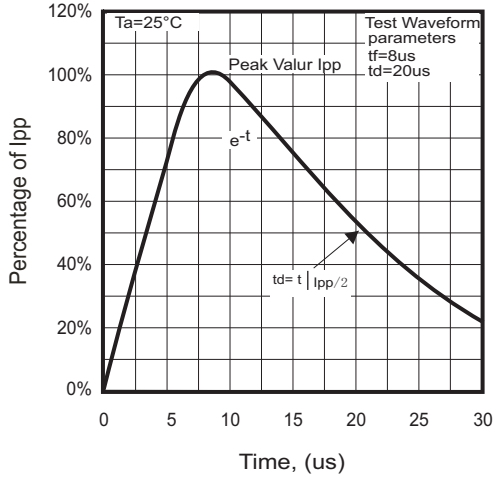

Fig.2 - Typical Capacitance Characteristics

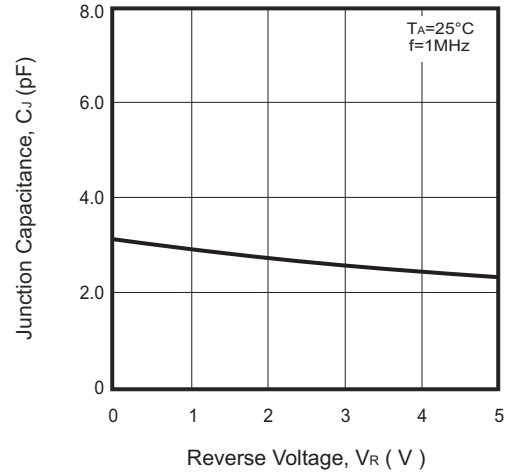
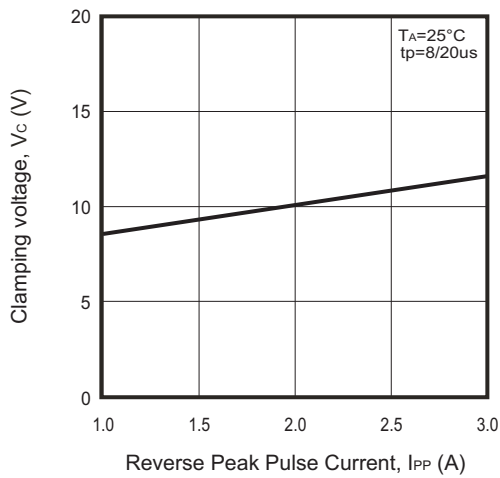
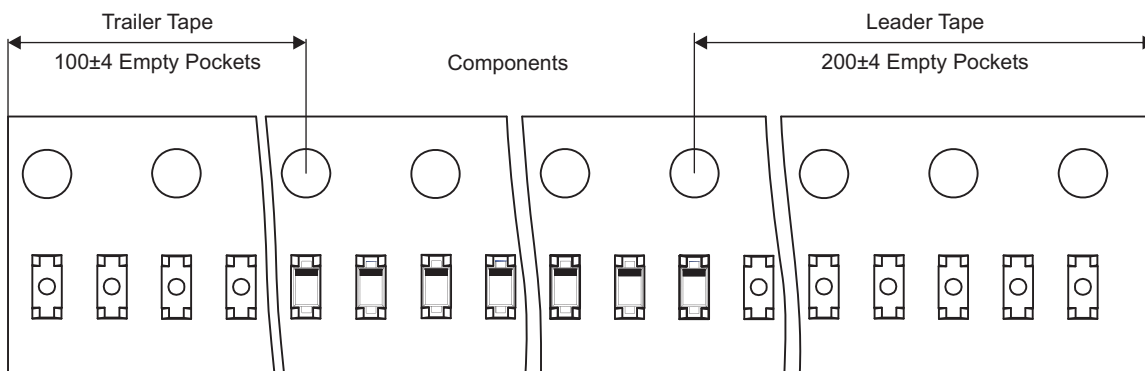
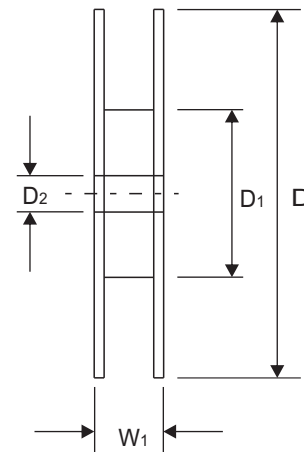
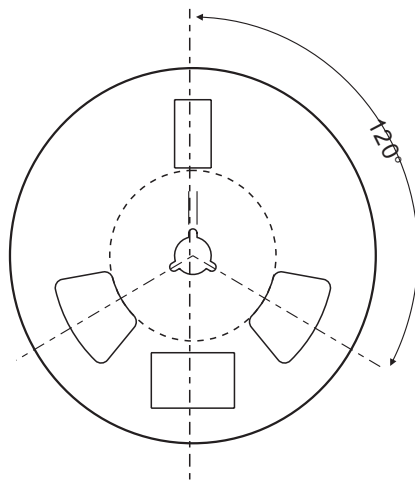
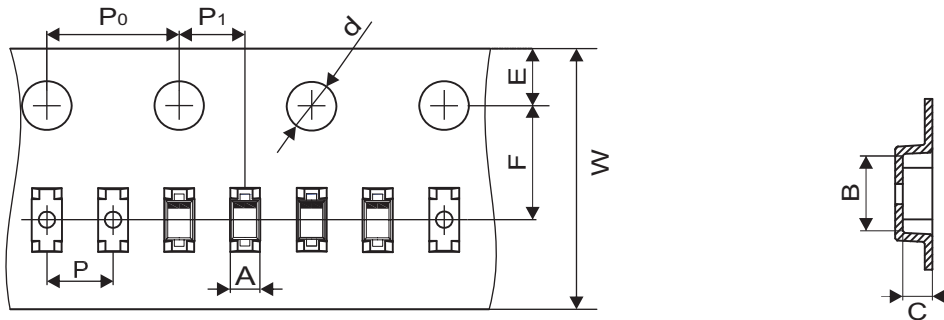

Fig.3 - Clamping Voltage Vs. Peak Pulse Current



## Reel Taping Specification



SOD-523	SYMBOL	A	B	C	d	D	D1	D2
	(mm)	0.90 ± 0.10	1.94 ± 0.10	0.73 ± 0.10	1.50 ± 0.10	178 ± 1.00	54.40 ± 0.40	13.00 ± 0.20
	(inch)	0.035 ± 0.004	0.076 ± 0.004	0.029 ± 0.004	0.059 ± 0.004	7.008 ± 0.039	2.142 ± 0.016	0.512 ± 0.008

SOD-523	SYMBOL	E	F	P	P0	P1	W	W1
	(mm)	1.75 ± 0.10	3.50 ± 0.05	2.00 ± 0.10	4.00 ± 0.10	2.00 ± 0.10	8.00 + 0.30 / - 0.10	12.30 ± 1.00
	(inch)	0.069 ± 0.004	0.138 ± 0.002	0.079 ± 0.004	0.158 ± 0.004	0.079 ± 0.004	0.315 + 0.012 / - 0.004	0.484 ± 0.039

### Marking Code

Part Number	Marking Code
CPDH5V0P-HF	HD



HD = Product type marking code  
 • = Halogen Free

### Suggested PAD Layout

SIZE	SOD-523	
	(mm)	(inch)
A	1.42	0.056
B	0.60	0.024
C	0.70	0.028
D	2.02	0.080
E	0.82	0.032

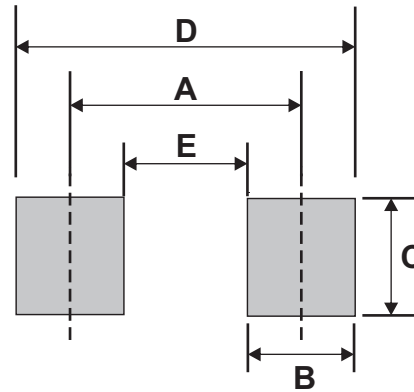



### Standard Packaging

Case Type	REEL PACK	
	REEL ( pcs )	Reel Size (inch)
SOD-523	8,000	7

## Looking for pricing, stock, or lifecycle information?

Click below to explore more details on WIN SOURCE:

-  [View CPDH5V0P-HF on WIN SOURCE](#)
-  [Comchip Technology Information](#)

## Optimize Your Supply Chain with WIN SOURCE Solutions

-  Global Sourcing Solution
-  Obsolete Management
-  Cost Control Management
-  Shortage Management
-  Alternative Solution
-  Excess Inventory Management