



**THE DATASHEET OF
CPDER5V0C-HF**



CPDER5V0C-HF

RoHS Device
Halogen Free

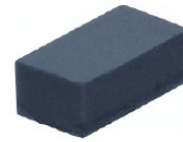

Features

- Bi-directional ESD protection.
- Surface mount package.
- Operating voltage: 5V.

Mechanical data

- Case: 0503/SOD-723F standard package, molded plastic.
- Terminals: Gold plated, solderable per MIL-STD-750, method 2026.
- Marking Code:
CPDER5V0C-HF: E05
- Mounting position: Any.
- Weight: 0.002 grams (approx.).

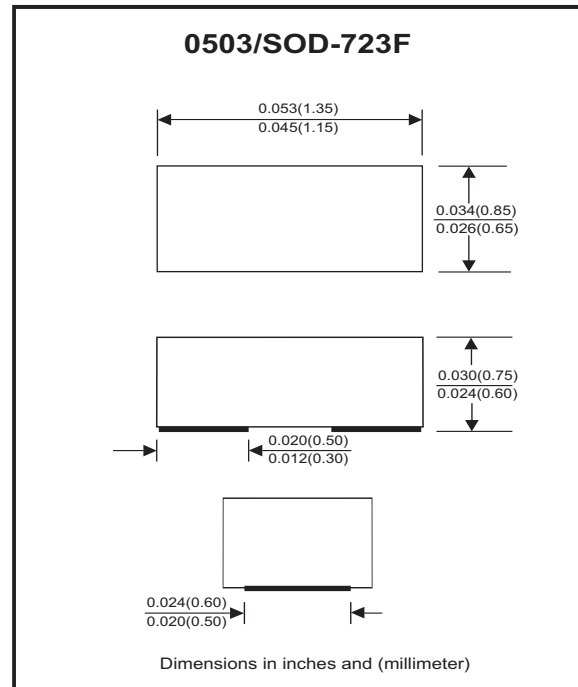

Circuit Diagram



Electrical Characteristics (at TA=25°C unless otherwise noted)

Parameter	Conditions	Symbol	Min	Typ	Max	Unit
Diode breakdown voltage	IR = 1mA	V _{BD}	6.1	7.0		V
Leakage current	VR = 5V	I _L		0.1	2.0	uA
Junction capacitance	VR = 0V, f = 1MHz	C _T		25	30	pF
ESD capability	IEC 61000-4-2(air) IEC 61000-4-2(contact)	ESD			16 8	kV
Clamping Voltage	I _{PP} = 1 A, tp=8/20us	V _c			10	V
	I _{PP} = 4 A, tp=8/20us	V _c			17	V
Peak Pulse Power	TP=8/20us	P _{PP}			58	W
Operation temperature range		T _J	-55		125	°C
Storage temperature range		T _{STG}	-55		150	°C

RATING AND CHARACTERISTIC CURVES (CPDER5V0C-HF)

Fig.1 - Reverse Characteristics

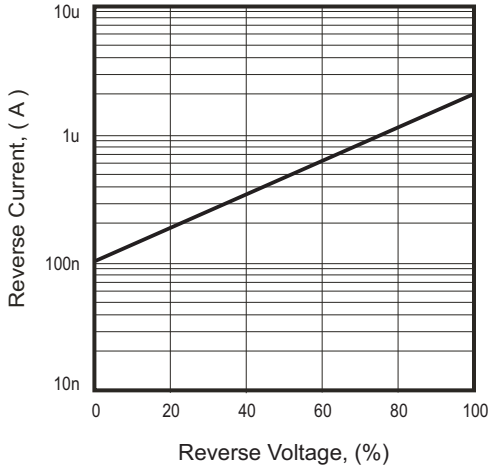

Fig.2 - Capacitance Between Terminals Characteristics

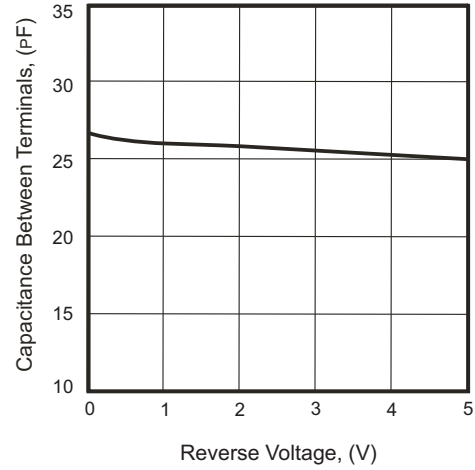

Fig.3 - Clamping Voltage Vs. Peak Pulse Current

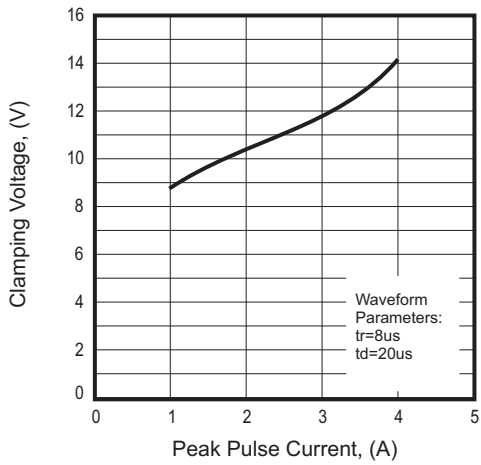
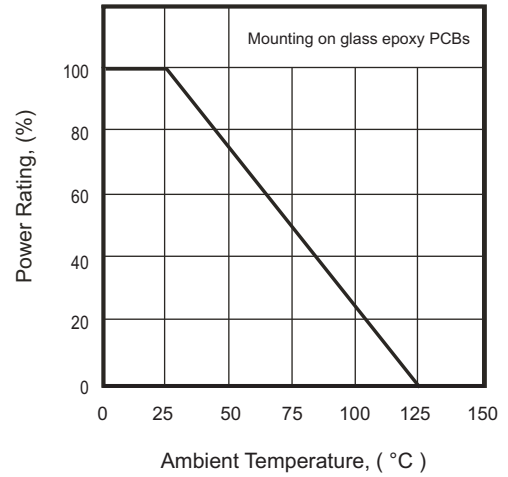
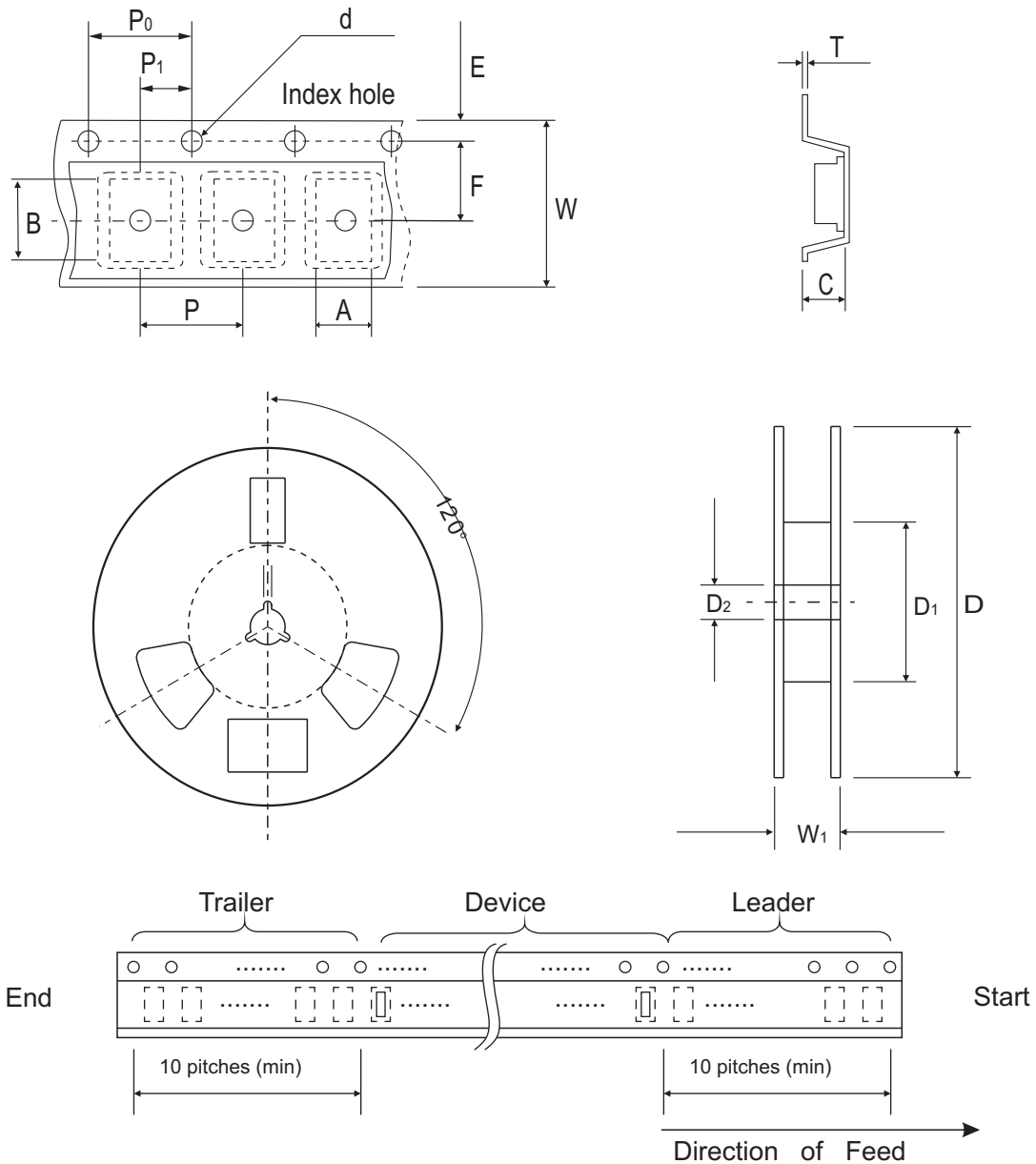

Fig.4 - Power Rating Derating Curve



Reel Taping Specification



0503 (SOD-723F)	SYMBOL	A	B	C	d	D	D ₁	D ₂
	(mm)	0.90 ± 0.10	1.46 ± 0.10	0.80 ± 0.10	1.55 ± 0.05	178 ± 1	60.0 MIN.	13.0 ± 0.20
	(inch)	0.035 ± 0.004	0.057 ± 0.004	0.031 ± 0.004	0.061 ± 0.002	7.008 ± 0.04	2.362 MIN.	0.512 ± 0.008

0503 (SOD-723F)	SYMBOL	E	F	P	P ₀	P ₁	T	W	W ₁
	(mm)	1.75 ± 0.10	3.50 ± 0.05	4.00 ± 0.10	4.00 ± 0.10	2.00 ± 0.10	0.22 ± 0.05	8.00 ± 0.20	13.5 MAX.
	(inch)	0.069 ± 0.004	0.138 ± 0.002	0.157 ± 0.004	0.157 ± 0.004	0.079 ± 0.004	0.008 ± 0.002	0.315 ± 0.008	0.531 MAX.

Marking Code

Part Number	Marking Code
CPDER5V0C-HF	E05



Suggested PAD Layout

SIZE	0503/SOD-723F	
	(mm)	(inch)
A	0.85	0.033
B	0.55	0.022
C	0.85	0.033
D	1.40	0.055
E	0.30	0.012

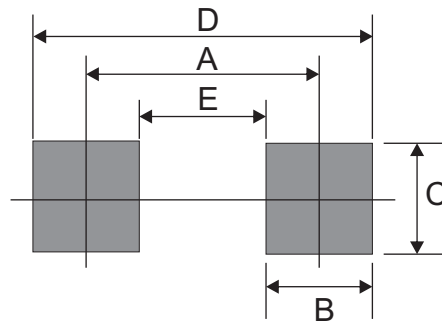

Standard Packaging

Case Type	Qty Per Reel	Reel Size
	(Pcs)	(inch)
0503/SOD-723F	4,000	7

Looking for pricing, stock, or lifecycle information?

Click below to explore more details on WIN SOURCE:

- ⊖ [View CPDER5V0C-HF](#) on WIN SOURCE
- ⊖ [Comchip Technology](#) Information

Optimize Your Supply Chain with WIN SOURCE Solutions

- ✓ Global Sourcing Solution
- ✓ Obsolete Management
- ✓ Cost Control Management
- ✓ Shortage Management
- ✓ Alternative Solution
- ✓ Excess Inventory Management