



**THE DATASHEET OF
MAX810SN293D3T1G**



MAX809 Series, MAX810 Series

Very Low Supply Current 3-Pin Microprocessor Reset Monitors

The MAX809 and MAX810 are cost-effective system supervisor circuits designed to monitor V_{CC} in digital systems and provide a reset signal to the host processor when necessary. No external components are required.

The reset output is driven active within 10 μ sec of V_{CC} falling through the reset voltage threshold. Reset is maintained active for a timeout period which is trimmed by the factory after V_{CC} rises above the reset threshold. The MAX810 has an active-high RESET output while the MAX809 has an active-low $\overline{\text{RESET}}$ output. Both devices are available in SOT-23 and SC-70 packages.

The MAX809/810 are optimized to reject fast transient glitches on the V_{CC} line. Low supply current of 0.5 μ A ($V_{CC} = 3.2$ V) makes these devices suitable for battery powered applications.

Features

- Precision V_{CC} Monitor for 1.5 V, 2.5 V, 3.0 V, 3.3 V, and 5.0 V Supplies
- Precision Monitoring Voltages from 1.2 V to 4.9 V Available in 100 mV Steps
- Four Guaranteed Minimum Power-On Reset Pulse Width Available (1 ms, 20 ms, 100 ms, and 140 ms)
- $\overline{\text{RESET}}$ Output Guaranteed to $V_{CC} = 1.0$ V.
- Low Supply Current
- Compatible with Hot Plug Applications
- V_{CC} Transient Immunity
- No External Components
- Wide Operating Temperature: -40°C to 105°C
- These Devices are Pb-Free and are RoHS Compliant

Typical Applications

- Computers
- Embedded Systems
- Battery Powered Equipment
- Critical Microprocessor Power Supply Monitoring

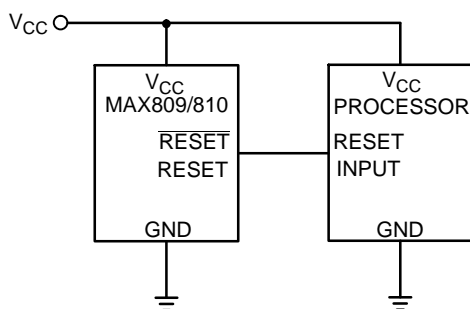

Figure 1. Typical Application Diagram



ON Semiconductor®

www.onsemi.com

MARKING DIAGRAM

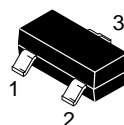

SOT-23
(TO-236)
CASE 318

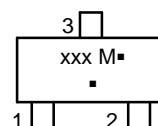

SC-70
(SOT-323)
CASE 419

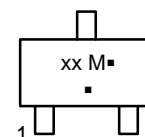

xxx = Specific Device Code
M = Date Code
▪ = Pb-Free Package
(Note: Microdot may be in either location)

PIN CONFIGURATION



SOT-23/SC-70
(Top View)

NOTE: $\overline{\text{RESET}}$ is for MAX809
RESET is for MAX810

ORDERING INFORMATION

See detailed ordering and shipping information in the package dimensions section on page 10 of this data sheet.

DEVICE MARKING INFORMATION

See general marking information in the device marking section on page 10 of this data sheet.

This document contains information on some products that are still under development. ON Semiconductor reserves the right to change or discontinue these products without notice.

MAX809 Series, MAX810 Series

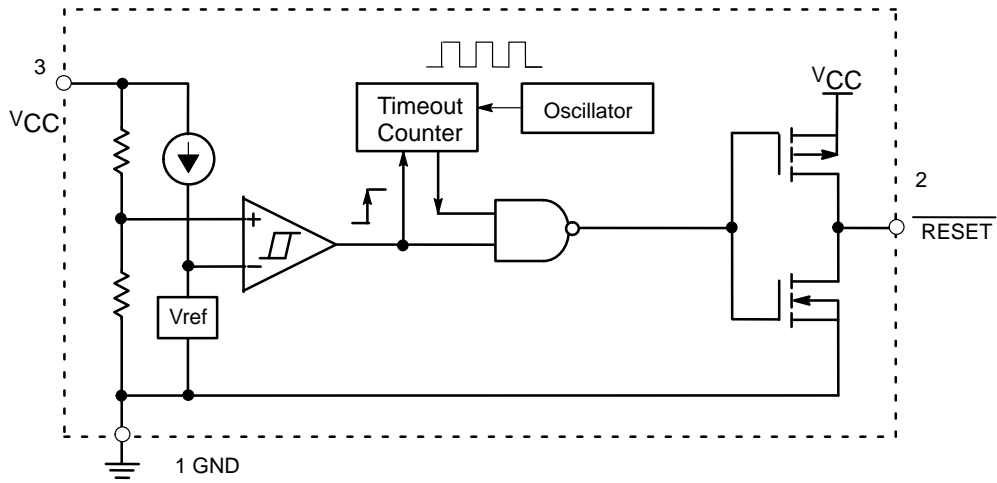

Figure 2. MAX809 Series Complementary Active-Low Output

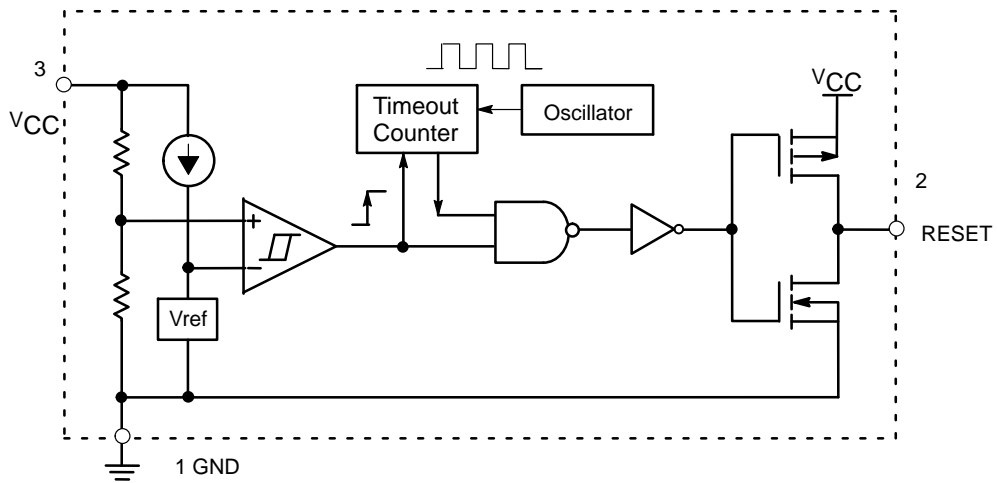

Figure 3. MAX810 Series Complementary Active-High Output

MAX809 Series, MAX810 Series

PIN DESCRIPTION

Pin No.	Symbol	Description
1	GND	Ground
2	RESET (MAX809)	RESET output remains low while V_{CC} is below the reset voltage threshold, and for a reset timeout period after V_{CC} rises above reset threshold
2	RESET (MAX810)	RESET output remains high while V_{CC} is below the reset voltage threshold, and for a reset timeout period after V_{CC} rises above reset threshold
3	V_{CC}	Supply Voltage (Typ)

ABSOLUTE MAXIMUM RATINGS

Rating	Symbol	Value	Unit
Power Supply Voltage (V_{CC} to GND)	V_{CC}	-0.3 to 6.0	V
RESET Output Voltage (CMOS)		-0.3 to ($V_{CC} + 0.3$)	V
Input Current, V_{CC}		20	mA
Output Current, $\overline{\text{RESET}}$		20	mA
dV/dt (V_{CC})		100	V/ μsec
Thermal Resistance, Junction-to-Air (Note 1)	SOT-23 SC-70 $R_{\theta JA}$	301 314	$^{\circ}\text{C}/\text{W}$
Operating Junction Temperature Range	T_J	-40 to +125	$^{\circ}\text{C}$
Storage Temperature Range	T_{stg}	-65 to +150	$^{\circ}\text{C}$
Lead Temperature (Soldering, 10 Seconds)	T_{sol}	+260	$^{\circ}\text{C}$
ESD Protection Human Body Model (HBM): Following Specification JESD22-A114 Machine Model (MM): Following Specification JESD22-A115		2000 200	V
Latchup Current Maximum Rating: Following Specification JESD78 Class II Positive Negative	I_{Latchup}	200 200	mA

Stresses exceeding those listed in the Maximum Ratings table may damage the device. If any of these limits are exceeded, device functionality should not be assumed, damage may occur and reliability may be affected.

1. This based on a 35x35x1.6mm FR4 PCB with 10mm² of 1 oz copper traces under natural convection conditions and a single component characterization.
2. The maximum package power dissipation limit must not be exceeded.

$$P_D = \frac{T_{J(\text{max})} - T_A}{R_{\theta JA}} \quad \text{with } T_{J(\text{max})} = 150^{\circ}\text{C}$$

MAX809 Series, MAX810 Series

ELECTRICAL CHARACTERISTICS $T_A = -40^{\circ}\text{C}$ to $+105^{\circ}\text{C}$ unless otherwise noted. Typical values are at $T_A = +25^{\circ}\text{C}$. (Note 3)

Characteristic	Symbol	Min	Typ	Max	Unit
V_{CC} Range $T_A = 0^{\circ}\text{C}$ to $+70^{\circ}\text{C}$ $T_A = -40^{\circ}\text{C}$ to $+105^{\circ}\text{C}$ (Note 4)		1.0 1.2	– –	5.5 5.5	V
Supply Current $V_{CC} = 3.3\text{ V}$ $T_A = -40^{\circ}\text{C}$ to $+85^{\circ}\text{C}$ $T_A = 85^{\circ}\text{C}$ to $+105^{\circ}\text{C}$ (Note 5) $V_{CC} = 5.5\text{ V}$ $T_A = -40^{\circ}\text{C}$ to $+85^{\circ}\text{C}$ $T_A = 85^{\circ}\text{C}$ to $+105^{\circ}\text{C}$ (Note 5)	I_{CC}	– –	0.5 –	1.2 2.0	μA
Reset Threshold (V_{in} Decreasing) (Note 6)	V_{TH}				V
MAX809SN490 $T_A = +25^{\circ}\text{C}$ $T_A = -40^{\circ}\text{C}$ to $+85^{\circ}\text{C}$ $T_A = +85^{\circ}\text{C}$ to $+105^{\circ}\text{C}$ (Note 5)		4.83 4.78 4.66	4.9 – –	4.97 5.02 5.14	
MAX8xxLTR, MAX8xxSQ463 $T_A = +25^{\circ}\text{C}$ $T_A = -40^{\circ}\text{C}$ to $+85^{\circ}\text{C}$ $T_A = +85^{\circ}\text{C}$ to $+105^{\circ}\text{C}$ (Note 5)		4.56 4.50 4.40	4.63 – –	4.70 4.75 4.86	
MAX809HTR $T_A = +25^{\circ}\text{C}$ $T_A = -40^{\circ}\text{C}$ to $+85^{\circ}\text{C}$ $T_A = +85^{\circ}\text{C}$ to $+105^{\circ}\text{C}$ (Note 5)		4.48 4.43 4.32	4.55	4.62 4.67 4.78	
MAX8xxMTR, MAX8xxSQ438 $T_A = +25^{\circ}\text{C}$ $T_A = -40^{\circ}\text{C}$ to $+85^{\circ}\text{C}$ $T_A = +85^{\circ}\text{C}$ to $+105^{\circ}\text{C}$ (Note 5)		4.31 4.27 4.16	4.38	4.45 4.49 4.60	
MAX809JTR, MAX8xxSQ400 $T_A = +25^{\circ}\text{C}$ $T_A = -40^{\circ}\text{C}$ to $+85^{\circ}\text{C}$ $T_A = +85^{\circ}\text{C}$ to $+105^{\circ}\text{C}$ (Note 5)		3.94 3.90 3.80	4.00 – –	4.06 4.10 4.20	
MAX8xxTTR, MAX809SQ308 $T_A = +25^{\circ}\text{C}$ $T_A = -40^{\circ}\text{C}$ to $+85^{\circ}\text{C}$ $T_A = +85^{\circ}\text{C}$ to $+105^{\circ}\text{C}$ (Note 5)		3.04 3.00 2.92	3.08 – –	3.11 3.16 3.24	
MAX8xxSTR, MAX8xxSQ293 $T_A = +25^{\circ}\text{C}$ $T_A = -40^{\circ}\text{C}$ to $+85^{\circ}\text{C}$ $T_A = +85^{\circ}\text{C}$ to $+105^{\circ}\text{C}$ (Note 5)		2.89 2.85 2.78	2.93 – –	2.96 3.00 3.08	
MAX8xxRTR, MAX8xxSQ263 $T_A = +25^{\circ}\text{C}$ $T_A = -40^{\circ}\text{C}$ to $+85^{\circ}\text{C}$ $T_A = +85^{\circ}\text{C}$ to $+105^{\circ}\text{C}$ (Note 5)		2.59 2.56 2.49	2.63 – –	2.66 2.70 2.77	
MAX809SN232, MAX809SQ232 $T_A = +25^{\circ}\text{C}$ $T_A = -40^{\circ}\text{C}$ to $+85^{\circ}\text{C}$ $T_A = +85^{\circ}\text{C}$ to $+105^{\circ}\text{C}$ (Note 5)		2.28 2.25 2.21	2.32 – –	2.35 2.38 2.45	
MAX809SN160 $T_A = +25^{\circ}\text{C}$ $T_A = -40^{\circ}\text{C}$ to $+85^{\circ}\text{C}$ $T_A = +85^{\circ}\text{C}$ to $+105^{\circ}\text{C}$ (Note 5)		1.58 1.56 1.52	1.60 – –	1.62 1.64 1.68	
MAX809SN120, MAX8xxSQ120 $T_A = +25^{\circ}\text{C}$ $T_A = -40^{\circ}\text{C}$ to $+85^{\circ}\text{C}$ $T_A = +85^{\circ}\text{C}$ to $+105^{\circ}\text{C}$ (Note 5)		1.18 1.17 1.14	1.20 – –	1.22 1.23 1.26	

Product parametric performance is indicated in the Electrical Characteristics for the listed test conditions, unless otherwise noted. Product performance may not be indicated by the Electrical Characteristics if operated under different conditions.

3. Production testing done at $T_A = 25^{\circ}\text{C}$, over temperature limits guaranteed by design.

4. For NCV automotive devices, this temperature range is $T_A = -40^{\circ}\text{C}$ to $+125^{\circ}\text{C}$.

5. For NCV automotive devices, this temperature range is $T_A = +85^{\circ}\text{C}$ to $+125^{\circ}\text{C}$.

6. Contact your ON Semiconductor sales representative for other threshold voltage options.

MAX809 Series, MAX810 Series

ELECTRICAL CHARACTERISTICS (continued) $T_A = -40^{\circ}\text{C}$ to $+105^{\circ}\text{C}$ unless otherwise noted. Typical values are at $T_A = +25^{\circ}\text{C}$. (Note 7)

Characteristic	Symbol	Min	Typ	Max	Unit
Detector Voltage Threshold Temperature Coefficient		–	30	–	ppm/ $^{\circ}\text{C}$
V_{CC} to Reset Delay $V_{CC} = V_{TH}$ to $(V_{TH} - 100\text{ mV})$		–	10	–	μsec
Reset Active TimeOut Period (Note 8) MAX8xxSN(Q)293D1 MAX8xxSN(Q)293D2 MAX8xxSN(Q)293D3 MAX8xxSN(Q)293	t_{RP}	1.0 20 100 140	– – – –	3.3 66 330 460	msec
RESET Output Voltage Low (No Load) (MAX809) $V_{CC} = V_{TH} - 0.2\text{ V}$ $1.6\text{ V} \leq V_{TH} \leq 2.0\text{ V}$, $I_{SINK} = 0.5\text{ mA}$ $2.1\text{ V} \leq V_{TH} \leq 4.0\text{ V}$, $I_{SINK} = 1.2\text{ mA}$ $4.1\text{ V} \leq V_{TH} \leq 4.9\text{ V}$, $I_{SINK} = 3.2\text{ mA}$	V_{OL}	–	–	0.3	V
RESET Output Voltage High (No Load) (MAX809) $V_{CC} = V_{TH} + 0.2\text{ V}$ $1.6\text{ V} \leq V_{TH} \leq 2.4\text{ V}$, $I_{SOURCE} = 200\text{ }\mu\text{A}$ $2.5\text{ V} \leq V_{TH} \leq 4.9\text{ V}$, $I_{SOURCE} = 500\text{ }\mu\text{A}$	V_{OH}	$0.8 V_{CC}$	–	–	V
RESET Output Voltage High (No Load) (MAX810) $V_{CC} = V_{TH} - 0.2\text{ V}$ $1.6\text{ V} \leq V_{TH} \leq 2.4\text{ V}$, $I_{SOURCE} = 200\text{ }\mu\text{A}$ $2.5\text{ V} \leq V_{TH} \leq 4.9\text{ V}$, $I_{SOURCE} = 500\text{ }\mu\text{A}$	V_{OH}	$0.8 V_{CC}$	–	–	V
RESET Output Voltage Low (No Load) (MAX810) $V_{CC} = V_{TH} + 0.2\text{ V}$ $1.6\text{ V} \leq V_{TH} \leq 2.0\text{ V}$, $I_{SINK} = 0.5\text{ mA}$ $2.1\text{ V} \leq V_{TH} \leq 4.0\text{ V}$, $I_{SINK} = 1.2\text{ mA}$ $4.1\text{ V} \leq V_{TH} \leq 4.9\text{ V}$, $I_{SINK} = 3.2\text{ mA}$	V_{OL}	–	–	0.3	V

Product parametric performance is indicated in the Electrical Characteristics for the listed test conditions, unless otherwise noted. Product performance may not be indicated by the Electrical Characteristics if operated under different conditions.

7. Production testing done at $T_A = 25^{\circ}\text{C}$, over temperature limits guaranteed by design.

8. Contact your ON Semiconductor sales representative for timeout options availability for other threshold voltage options.

MAX809 Series, MAX810 Series

TYPICAL OPERATING CHARACTERISTICS



Figure 4. Supply Current vs. Supply Voltage



Figure 5. Supply Current vs. Supply Voltage

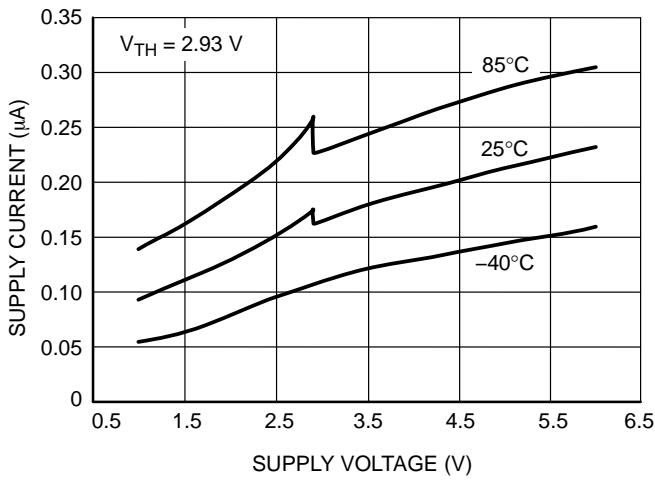

Figure 6. Supply Current vs. Supply Voltage

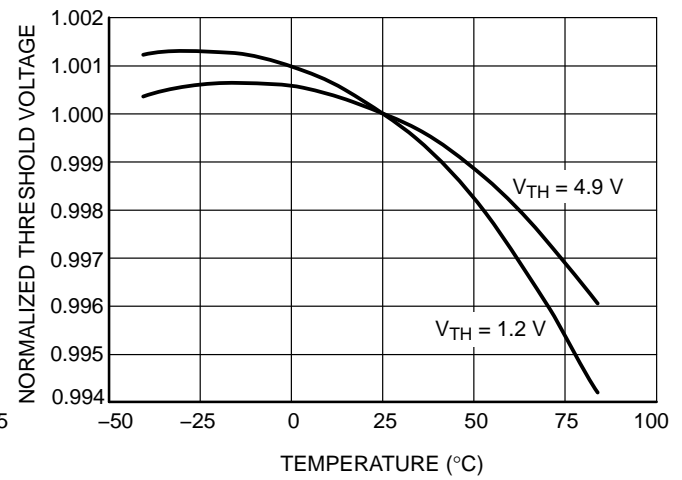

Figure 7. Normalized Reset Threshold Voltage vs. Temperature

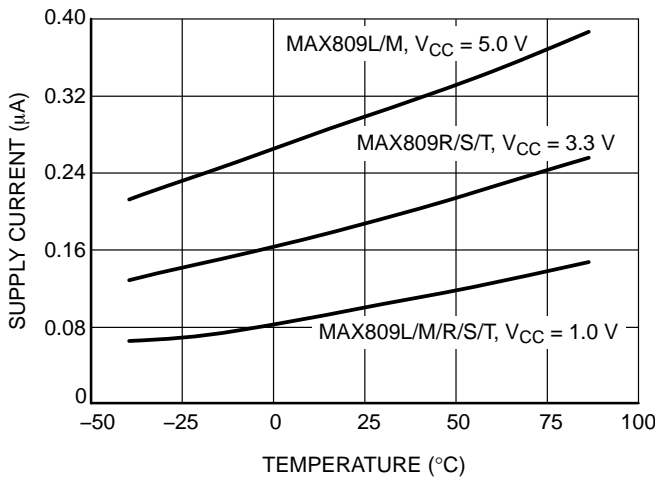

Figure 8. Supply Current vs. Temperature (No Load, MAX809)

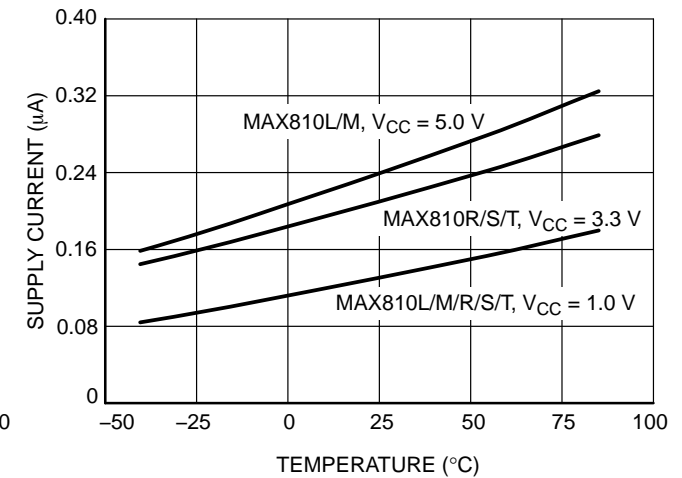

Figure 9. Supply Current vs. Temperature (No Load, MAX810)

MAX809 Series, MAX810 Series

TYPICAL OPERATING CHARACTERISTICS



Figure 10. Output Voltage Low vs. Supply Voltage

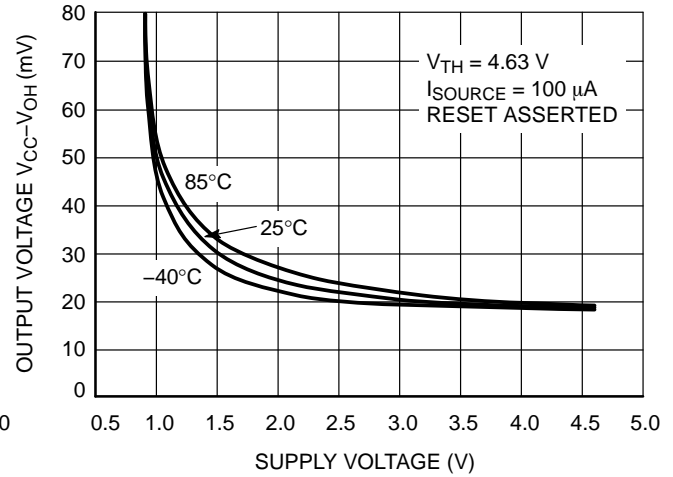

Figure 11. Output Voltage High vs. Supply Voltage

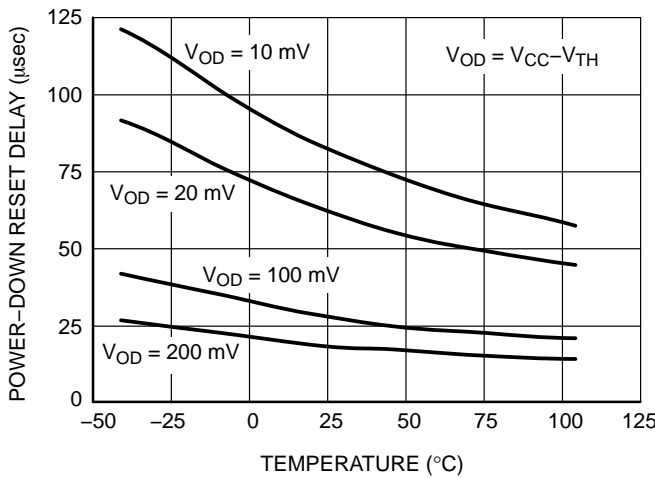

Figure 12. Power-Down Reset Delay vs. Temperature and Overdrive ($V_{TH} = 1.2 V$)

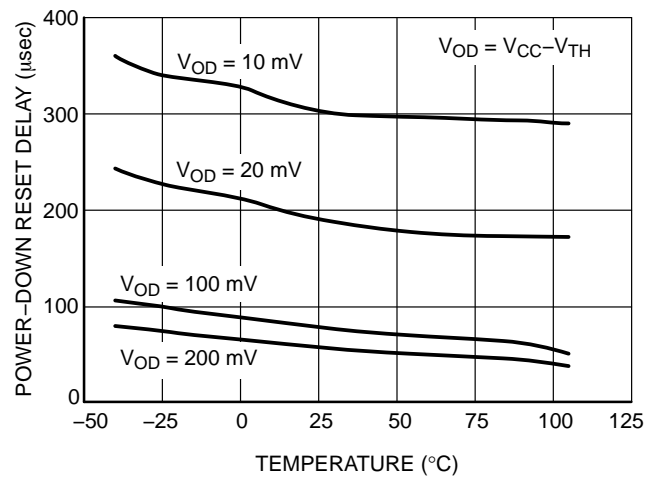

Figure 13. Power-Down Reset Delay vs. Temperature and Overdrive ($V_{TH} = 4.9 V$)



Figure 14. Normalized Power-Up Reset vs. Temperature

MAX809 Series, MAX810 Series

Detail Operation Description

The MAX809/810 series microprocessor reset supervisory circuits are designed to monitor the power supplies in digital systems and provide a reset signal to the processor without any external components. Figure 2 shows the timing diagram and a typical application below. Initially consider that input voltage V_{CC} is at a nominal level greater than the voltage detector upper threshold (V_{TH+}). And the $\overline{\text{RESET}}$ (RESET) output voltage (Pin 2) will be in the high state for MAX809, or in the low state for MAX 810 devices.

If there is an input power interruption and V_{CC} becomes significantly deficient, it will fall below the lower detector threshold (V_{TH-}). This event causes the RESET output to be in the low state for the MAX809, or in the high state for the NCP810 devices. After completion of the power interruption, V_{CC} will rise to its nominal level and become greater than the V_{TH} . This sequence activates the internal oscillator circuitry and digital counter to count. After the count of the timeout period, the reset output will revert back to the original state.



Figure 15. Timing Waveforms

APPLICATIONS INFORMATION

V_{CC} Transient Rejection

The MAX809 provides accurate V_{CC} monitoring and reset timing during power-up, power-down, and brownout/sag conditions, and rejects negative-going transients (glitches) on the power supply line. Figure 16 shows the maximum transient duration vs. maximum negative excursion (overdrive) for glitch rejection. Any combination of duration and overdrive which lies **under** the curve will **not** generate a reset signal. Combinations above the curve are detected as a brownout or power-down. Typically, transient that goes 100 mV below the reset threshold and lasts 5.0 μs or less will not cause a reset pulse. Transient immunity can be improved by adding a capacitor in close proximity to the V_{CC} pin of the MAX809.

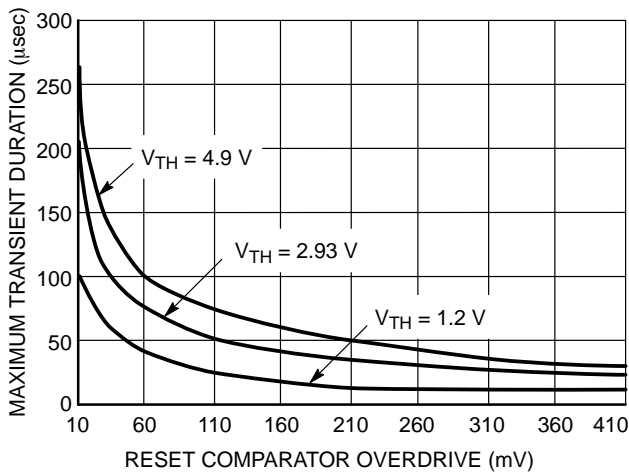
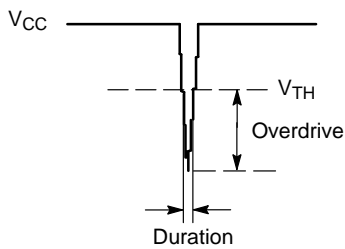

Figure 16. Maximum Transient Duration vs. Overdrive for Glitch Rejection at 25°C

RESET Signal Integrity During Power-Down

The MAX809 RESET output is valid to V_{CC} = 1.0 V. Below this voltage the output becomes an “open circuit” and does not sink current. This means CMOS logic inputs to the Microprocessor will be floating at an undetermined voltage. Most digital systems are completely shutdown well above this voltage. However, in situations where RESET must be

maintained valid to V_{CC} = 0 V, a pull-down resistor must be connected from RESET to ground to discharge stray capacitances and hold the output low (Figure 17). This resistor value, though not critical, should be chosen such that it does not appreciably load RESET under normal operation (100 kΩ will be suitable for most applications).

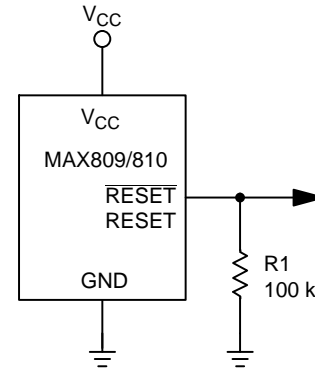

Figure 17. Ensuring RESET Valid to V_{CC} = 0 V

Processors With Bidirectional I/O Pins

Some Microprocessor's have bidirectional reset pins. Depending on the current drive capability of the processor pin, an indeterminate logic level may result if there is a logic conflict. This can be avoided by adding a 4.7 kΩ resistor in series with the output of the MAX809 (Figure 18). If there are other components in the system which require a reset signal, they should be buffered so as not to load the reset line. If the other components are required to follow the reset I/O of the Microprocessor, the buffer should be connected as shown with the solid line.

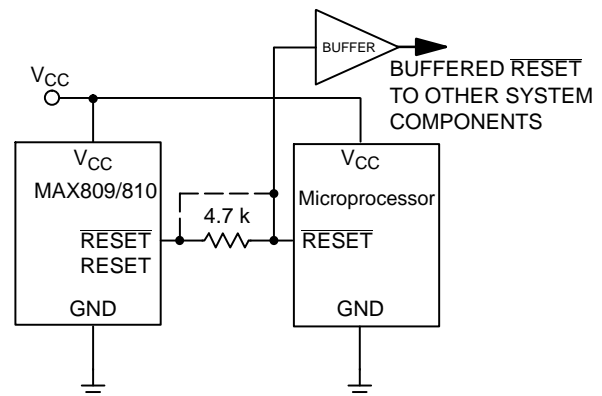

Figure 18. Interfacing to Bidirectional Reset I/O

MAX809 Series, MAX810 Series

ORDERING, MARKING AND THRESHOLD INFORMATION

Part Number	V _{TH} * (V)	Timeout* (ms)	Description	Marking	Package	Shipping†
MAX809SN160T1G	1.60	140–460	Push–Pull $\overline{\text{RESET}}$	SAA	SOT23–3 (Pb–Free)	3000 / Tape & Reel
MAX809SN232T1G	2.32	140–460		SQP		
MAX809RTRG	2.63	140–460		SPS		
NCV809RTRG	2.63	140–460		RPA		
MAX809STRG	2.93	140–460		SPT		
NCV809STRG	2.93	140–460		SUC		
MAX809TTRG	3.08	140–460		SPU		
MAX809JTRG	4.00	140–460		SPR		
MAX809MTRG	4.38	140–460		SPV		
NCV809MTRG	4.38	140–460		TAT		
MAX809HTRG	4.55	140–460		SBD		
MAX809LTRG	4.63	140–460		SPW		
NCV809LTRG	4.63	140–460		STA		
MAX809SN490T1G	4.90	140–460		SBH		
MAX809SN120T1G	1.20	140–460		SSO		
MAX809SN293D1T1G	2.93	1–3.3		SSP		
NCV809SN293D1T1G*				ACT		
MAX809SN293D2T1G	2.93	20–66		SSQ		
NCV809SN293D2T1G	2.93	20–66		ACE		
MAX809SN293D3T1G	2.93	100–330		SSR		
MAX809SQ120T1G	1.20	140–460		ZD	SC70–3 (Pb–Free)	3000 / Tape & Reel
MAX809SQ232T1G	2.32	140–460		ZE		
MAX809SQ263T1G	2.63	140–460		ZF		
MAX809SQ293T1G	2.93	140–460		ZG		
NCV809SQ293T1G* (In Development)				ZH		
MAX809SQ308T1G	3.08	140–460		SZ		
MAX809SQ400T1G	4.00	140–460		ZI		
MAX809SQ438T1G	4.38	140–460		ZJ		
MAX809SQ463T1G	4.63	140–460	ZK			
MAX809SQ293D1T1G	2.93	1–3.3	ZL			
MAX809SQ293D2T1G	2.93	20–66	ZM			
MAX809SQ293D3T1G	2.93	100–330				

MAX809 Series, MAX810 Series

ORDERING, MARKING AND THRESHOLD INFORMATION

Part Number	V _{TH} ** (V)	Timeout** (ms)	Description	Marking	Package	Shipping†
MAX810RTRG	2.63	140–460	Push–Pull RESET	SPX	SOT23–3 (Pb–Free)	3000 / Tape & Reel
MAX810STRG	2.93	140–460		SPY		
MAX810TTRG	3.08	140–460		SPZ		
MAX810MTRG	4.38	140–460		SQA		
MAX810LTRG	4.63	140–460		SQB		
MAX810SN120T1G	1.20	140–460		SSS		
MAX810SN293D1T1G	2.93	1–3.3		SST		
MAX810SN293D2T1G	2.93	20–66		SSU		
MAX810SN293D3T1G	2.93	100–330		SSZ		
MAX810SQ120T1G	1.20	140–460		ZN		
MAX810SQ263T1G	2.63	140–460		ZO		
MAX810SQ270T1G	2.70	20–66		ZB		
MAX810SQ293T1G	2.93	140–460		ZP		
MAX810SQ400T1G	4.00	20–66		ZC		
MAX810SQ438T1G	4.38	140–460		ZQ		
MAX810SQ463T1G	4.63	140–460		ZR		
MAX810SQ293D1T1G	2.93	1–3.3		ZS		
MAX810SQ293D2T1G	2.93	20–66		ZT		
MAX810SQ293D3T1G	2.93	100–330		ZU		

†For information on tape and reel specifications, including part orientation and tape sizes, please refer to our Tape and Reel Packaging Specifications Brochure, BRD8011/D.

*NCV Prefix for Automotive and Other Applications Requiring Unique Site and Control Change Requirements; AEC–Q100 Qualified and PPAP Capable.

**Contact your ON Semiconductor sales representative for other threshold voltage options.

MAX809 Series, MAX810 Series

PACKAGE DIMENSIONS

SOT-23 (TO-236)
CASE 318-08
ISSUE AR



NOTES:

1. DIMENSIONING AND TOLERANCING PER ASME Y14.5M, 1994.
2. CONTROLLING DIMENSION: MILLIMETERS.
3. MAXIMUM LEAD THICKNESS INCLUDES LEAD FINISH. MINIMUM LEAD THICKNESS IS THE MINIMUM THICKNESS OF THE BASE MATERIAL.
4. DIMENSIONS D AND E DO NOT INCLUDE MOLD FLASH, PROTRUSIONS, OR GATE BURRS.

DIM	MILLIMETERS			INCHES		
	MIN	NOM	MAX	MIN	NOM	MAX
A	0.89	1.00	1.11	0.035	0.039	0.044
A1	0.01	0.06	0.10	0.000	0.002	0.004
b	0.37	0.44	0.50	0.015	0.017	0.020
c	0.08	0.14	0.20	0.003	0.006	0.008
D	2.80	2.90	3.04	0.110	0.114	0.120
E	1.20	1.30	1.40	0.047	0.051	0.055
e	1.78	1.90	2.04	0.070	0.075	0.080
L	0.30	0.43	0.55	0.012	0.017	0.022
L1	0.35	0.54	0.69	0.014	0.021	0.027
HE	2.10	2.40	2.64	0.083	0.094	0.104
T	0°	---	10°	0°	---	10°

RECOMMENDED SOLDERING FOOTPRINT*

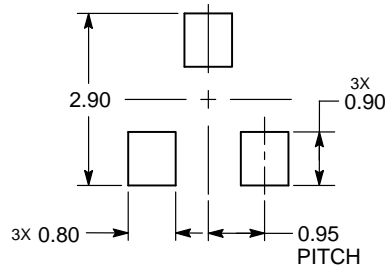

DIMENSIONS: MILLIMETERS

*For additional information on our Pb-Free strategy and soldering details, please download the ON Semiconductor Soldering and Mounting Techniques Reference Manual, SOLDERRM/D.

MAX809 Series, MAX810 Series

PACKAGE DIMENSIONS

SC-70 (SOT-323)
CASE 419-04
ISSUE N

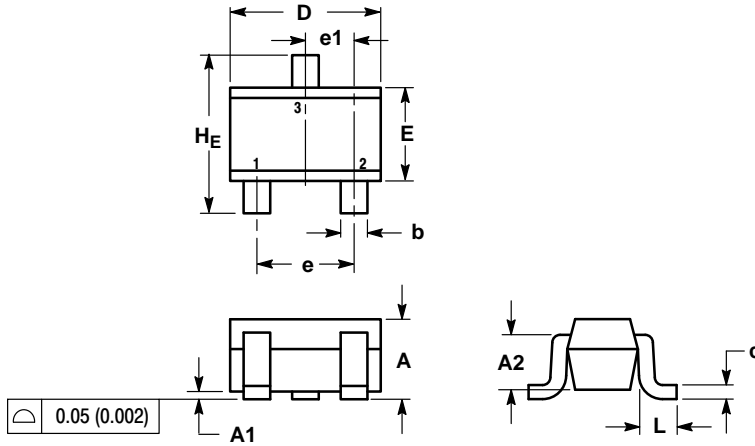

NOTES:

1. DIMENSIONING AND TOLERANCING PER ANSI Y14.5M, 1982.
2. CONTROLLING DIMENSION: INCH.

DIM	MILLIMETERS			INCHES		
	MIN	NOM	MAX	MIN	NOM	MAX
A	0.80	0.90	1.00	0.032	0.035	0.040
A1	0.00	0.05	0.10	0.000	0.002	0.004
A2	0.70 REF			0.028 REF		
b	0.30	0.35	0.40	0.012	0.014	0.016
c	0.10	0.18	0.25	0.004	0.007	0.010
D	1.80	2.10	2.20	0.071	0.083	0.087
E	1.15	1.24	1.35	0.045	0.049	0.053
e	1.20	1.30	1.40	0.047	0.051	0.055
e1	0.65 BSC			0.026 BSC		
L	0.20	0.38	0.56	0.008	0.015	0.022
HE	2.00	2.10	2.40	0.079	0.083	0.095

SOLDERING FOOTPRINT*

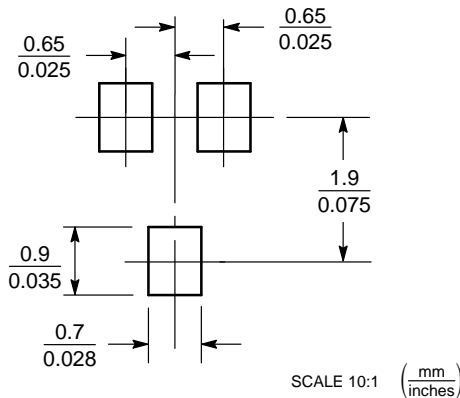

*For additional information on our Pb-Free strategy and soldering details, please download the ON Semiconductor Soldering and Mounting Techniques Reference Manual, SOLDERRM/D.

ON Semiconductor and are trademarks of Semiconductor Components Industries, LLC dba ON Semiconductor or its subsidiaries in the United States and/or other countries. ON Semiconductor owns the rights to a number of patents, trademarks, copyrights, trade secrets, and other intellectual property. A listing of ON Semiconductor's product/patent coverage may be accessed at www.onsemi.com/site/pdf/Patent-Marking.pdf. ON Semiconductor reserves the right to make changes without further notice to any products herein. ON Semiconductor makes no warranty, representation or guarantee regarding the suitability of its products for any particular purpose, nor does ON Semiconductor assume any liability arising out of the application or use of any product or circuit, and specifically disclaims any and all liability, including without limitation special, consequential or incidental damages. Buyer is responsible for its products and applications using ON Semiconductor products, including compliance with all laws, regulations and safety requirements or standards, regardless of any support or applications information provided by ON Semiconductor. "Typical" parameters which may be provided in ON Semiconductor data sheets and/or specifications can and do vary in different applications and actual performance may vary over time. All operating parameters, including "Typicals" must be validated for each customer application by customer's technical experts. ON Semiconductor does not convey any license under its patent rights nor the rights of others. ON Semiconductor products are not designed, intended, or authorized for use as a critical component in life support systems or any FDA Class 3 medical devices or medical devices with a same or similar classification in a foreign jurisdiction or any devices intended for implantation in the human body. Should Buyer purchase or use ON Semiconductor products for any such unintended or unauthorized application, Buyer shall indemnify and hold ON Semiconductor and its officers, employees, subsidiaries, affiliates, and distributors harmless against all claims, costs, damages, and expenses, and reasonable attorney fees arising out of, directly or indirectly, any claim of personal injury or death associated with such unintended or unauthorized use, even if such claim alleges that ON Semiconductor was negligent regarding the design or manufacture of the part. ON Semiconductor is an Equal Opportunity/Affirmative Action Employer. This literature is subject to all applicable copyright laws and is not for resale in any manner.

PUBLICATION ORDERING INFORMATION

LITERATURE FULFILLMENT:
Literature Distribution Center for ON Semiconductor
19521 E. 32nd Pkwy, Aurora, Colorado 80011 USA
Phone: 303-675-2175 or 800-344-3860 Toll Free USA/Canada
Fax: 303-675-2176 or 800-344-3867 Toll Free USA/Canada
Email: orderlit@onsemi.com

N. American Technical Support: 800-282-9855 Toll Free
USA/Canada
Europe, Middle East and Africa Technical Support:
Phone: 421 33 790 2910
Japan Customer Focus Center
Phone: 81-3-5817-1050

ON Semiconductor Website: www.onsemi.com
Order Literature: <http://www.onsemi.com/orderlit>
For additional information, please contact your local Sales Representative

Looking for pricing, stock, or lifecycle information?

Click below to explore more details on WIN SOURCE:

 [View MAX810SN293D3T1G on WIN SOURCE](#)

 [ON Semiconductor](#) Information

Optimize Your Supply Chain with WIN SOURCE Solutions

-  Global Sourcing Solution
-  Obsolete Management
-  Cost Control Management
-  Shortage Management
-  Alternative Solution
-  Excess Inventory Management