



**THE DATASHEET OF
HSMP-3880-TR1G**



Surface Mount RF PIN Switch Diode

Technical Data

HSMP-3880

Features

- **Diodes Optimized for:
Ultra-Low Distortion
Switching**
- **Surface Mount SOT-23
Package
Tape and Reel Options
Available**
- **Low Failure in Time (FIT)
Rate¹**
- **Lead-free Option Available**

Package Lead Code Identification (Top View)

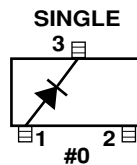

Description/Applications

The HSMP-3880 switching diode is an ultra low distortion device optimized for higher power applications to 1.5 GHz.

A SPICE model is not available for PIN diodes as SPICE does not provide for a key PIN diode characteristic, carrier lifetime.

Note:

1. For more information see the Surface Mount PIN Reliability Data Sheet.
-

Absolute Maximum Ratings^[1] $T_C = 25^\circ\text{C}$

Symbol	Parameter	Units	Absolute Maximum
I_F	Forward Current (1 ms Pulse)	Amp	1
P_t	Total Device Dissipation	mW ^[2]	250
P_{iv}	Peak Inverse Voltage	—	Same as V_{BR}
T_j	Junction Temperature	$^\circ\text{C}$	150
T_{STG}	Storage Temperature	$^\circ\text{C}$	-65 to 150

Notes:

1. Operation in excess of any one of these conditions may result in permanent damage to this device.
2. CW Power Dissipation at $T_{LEAD} = 25^\circ\text{C}$. Derate to zero at maximum rated temperature.

Typical Parameters at $T_C = 25^\circ\text{C}$

Part Number HSMP-	Series Resistance R_S (Ω)	Carrier Lifetime τ (ns)	Reverse Recovery Time T_{rr} (ns)	Total Capacitance C_T (pF)
3880	3.8	2500	550	0.30 @ 50 V
Test Conditions	$I_F = 1$ mA $f = 100$ MHz	$I_F = 50$ mA $I_R = 250$ mA	$V_R = 10$ V $I_F = 20$ mA 90% Recovery	

Electrical Specifications $T_C = 25^\circ\text{C}$

Part Number HSMP-	Package Marking Code ^[1]	Lead Code	Configuration	Minimum Breakdown Voltage V_{BR} (V)	Maximum Series Resistance R_S (Ω)	Maximum Total Capacitance C_T (pF)	Maximum Shunt Mode Harmonic Distortion Hmd (dBc)
3880	S0	0	Single	100	6.5	0.40	-55
Test Conditions				$V_R = V_{BR}$ Measure $I_R \leq 10$ μA	$I_F = 5$ mA $f = 100$ MHz	$V_R = 50$ V $f = 1$ MHz	$2f_o, Z_o = 50$ W $f_o = 400$ MHz $P_{in} = +30$ dBm 0 V bias

Note:

1. Package marking code is white.

Typical Parameters at $T_C = 25^\circ\text{C}$ (unless otherwise noted), Single Diode

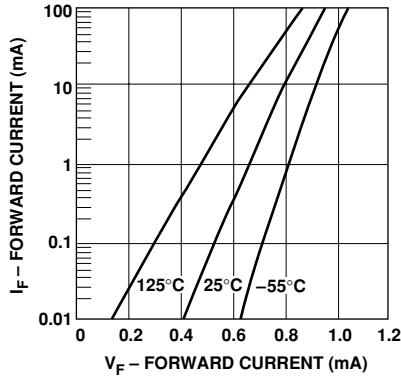

Figure 1. Forward Current vs. Forward Voltage.

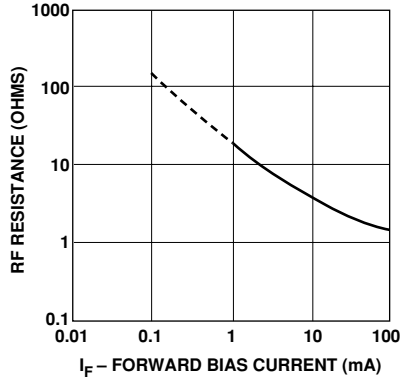

Figure 2. RF Resistance at 25°C vs. Forward Bias Current.

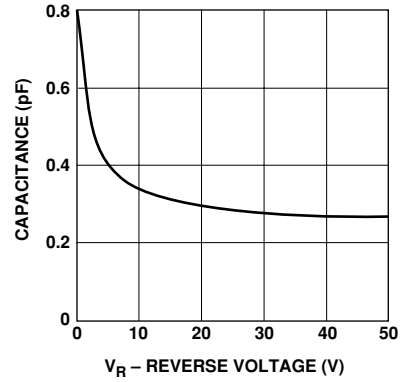

Figure 3. Capacitance vs. Reverse Voltage.

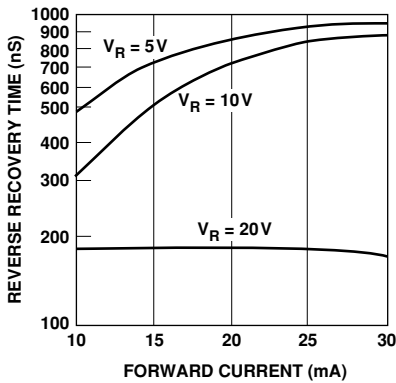

Figure 4. Typical Reverse Recovery Time vs. Reverse Voltage.

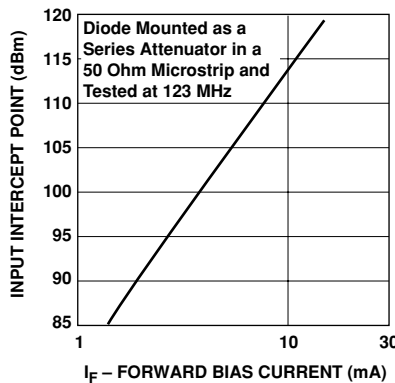
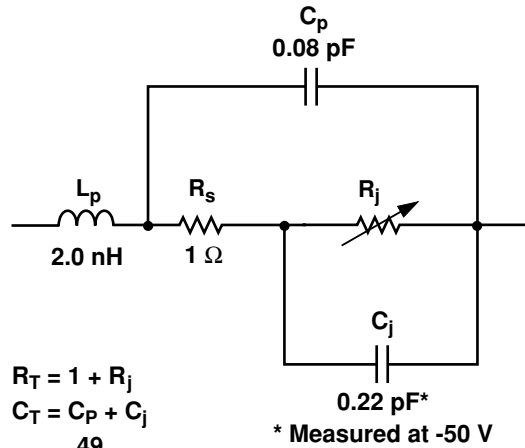

Figure 5. 2nd Harmonic Input Intercept Point vs. Forward Bias Current.

**Equivalent Circuit Model
HSMP-3880**



$$R_T = 1 + R_j$$

$$C_T = C_p + C_j$$

$$R_j = \frac{49}{I^{0.9}} \Omega$$

I = Forward Bias Current in mA

Package Dimensions Outline 23 (SOT-23)

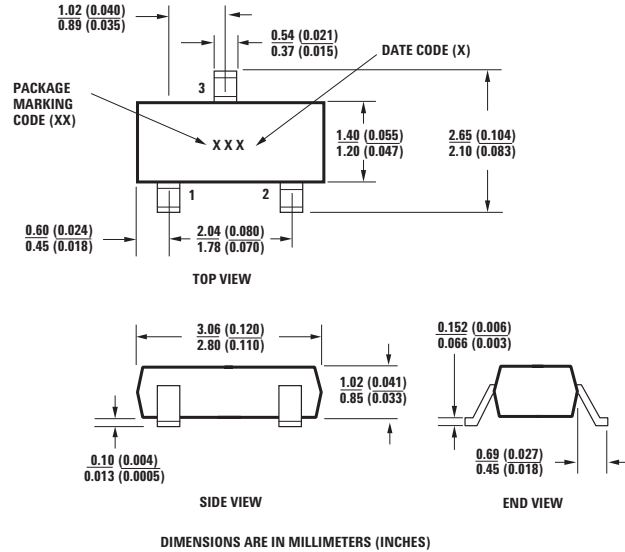

PC Board Footprints SOT-23

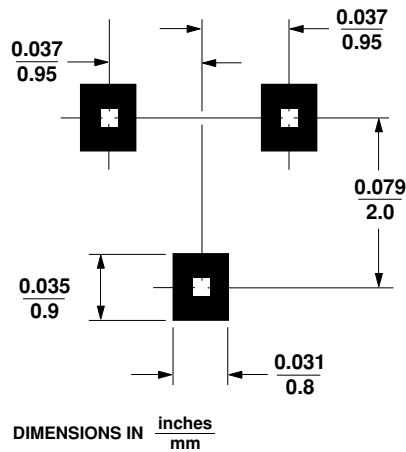

Package Characteristics

Lead Material	Alloy 42
Lead Finish	Tin-Lead 85-15%
Maximum Soldering Temperature	260°C for 5 seconds
Minimum Lead Strength	2 pounds pull
Typical Package Inductance	2 nH
Typical Package Capacitance	0.08 pF (opposite leads)

Profile Option Descriptions

-BLK = Bulk

-TR1 = 3K pc. Tape and Reel, Device Orientation; See Figure 6

-TR2 = 10K pc. Tape and Reel, Device Orientation; See Figure 6

Tape and Reeling conforms to Electronic Industries RS-481, "Taping of Surface Mounted Components for Automated Placement."

For lead-free option, the part number will have the character "G" at the end, e.g., TR2G for a 10K pc lead-free reel.

Ordering Information

Specify part number followed by option under. For example:

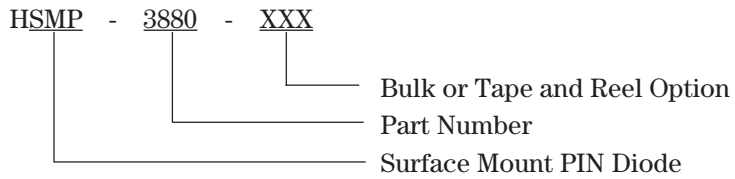

Device Orientation For Outline SOT-23

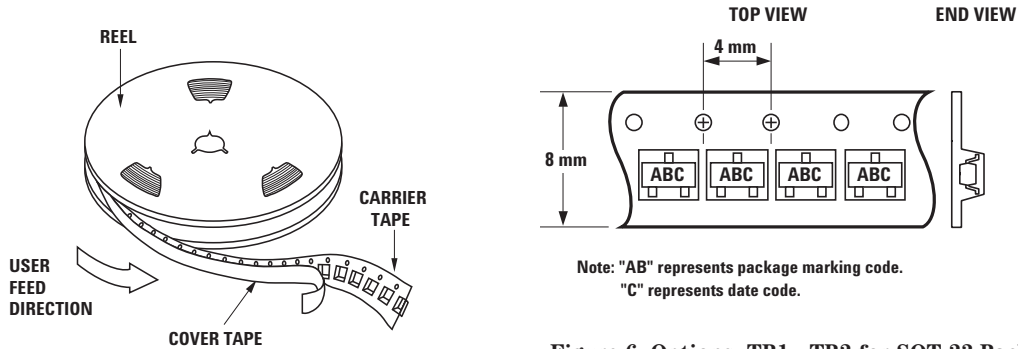
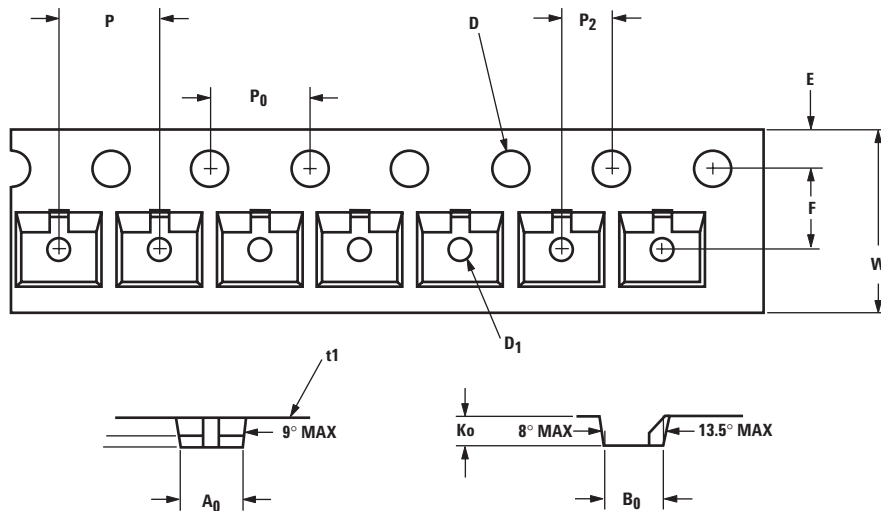

Figure 6. Options -TR1, -TR2 for SOT-23 Package.

Tape Dimensions and Product Orientation For Outline SOT-23



DESCRIPTION		SYMBOL	SIZE (mm)	SIZE (INCHES)
CAVITY	LENGTH	A ₀	3.15 ± 0.10	0.124 ± 0.004
	WIDTH	B ₀	2.77 ± 0.10	0.109 ± 0.004
	DEPTH	K ₀	1.22 ± 0.10	0.048 ± 0.004
	PITCH	P	4.00 ± 0.10	0.157 ± 0.004
	BOTTOM HOLE DIAMETER	D ₁	1.00 + 0.05	0.039 ± 0.002
PERFORATION	DIAMETER	D	1.50 + 0.10	0.059 + 0.004
	PITCH	P ₀	4.00 ± 0.10	0.157 ± 0.004
	POSITION	E	1.75 ± 0.10	0.069 ± 0.004
CARRIER TAPE	WIDTH	W	8.00 + 0.30 - 0.10	0.315 + 0.012 - 0.004
	THICKNESS	t ₁	0.229 ± 0.013	0.009 ± 0.0005
DISTANCE BETWEEN CENTERLINE	CAVITY TO PERFORATION (WIDTH DIRECTION)	F	3.50 ± 0.05	0.138 ± 0.002
	CAVITY TO PERFORATION (LENGTH DIRECTION)	P ₂	2.00 ± 0.05	0.079 ± 0.002

www.agilent.com/semiconductors

For product information and a complete list of distributors, please go to our web site.

For technical assistance call:

Americas/Canada: +1 (800) 235-0312 or (916) 788-6763

Europe: +49 (0) 6441 92460

China: 10800 650 0017

Hong Kong: (65) 6756 2394

India, Australia, New Zealand: (65) 6755 1939

Japan: (+81 3) 3335-8152(Domestic/International), or 0120-61-1280(Domestic Only)

Korea: (65) 6755 1989

Singapore, Malaysia, Vietnam, Thailand, Philippines, Indonesia: (65) 6755 2044

Taiwan: (65) 6755 1843

Data subject to change.

Copyright © 2004 Agilent Technologies, Inc.

Obsoletes 5968-7702E

March 24, 2004

5988-9924EN

Looking for pricing, stock, or lifecycle information?

Click below to explore more details on WIN SOURCE:

 [View HSMP-3880-TR1G on WIN SOURCE](#)

 [Broadcom Limited](#) Information

Optimize Your Supply Chain with WIN SOURCE Solutions

-  Global Sourcing Solution
-  Obsolete Management
-  Cost Control Management
-  Shortage Management
-  Alternative Solution
-  Excess Inventory Management